



TRIO  
LIGHTING FOR YOU



OUTDOOR

AUSSENLEUCHTEN | 2024  
OUTDOOR LUMINAIRES

power efficiency. We hope you enjoy our new outdoor collection.

Dès que le soleil se couche, un éclairage extérieur innovant est indispensable. Un espace extérieur bien éclairé offre non seulement la sécurité, mais vous aide aussi à vous orienter et crée une agréable ambiance autour de votre maison. Les luminaires extérieurs doivent répondre à des exigences de qualité élevées afin de résister sans dommage aux aléas climatiques telles que l'humidité, la pluie, la neige et les variations saisonnières de température. Nos luminaires d'extérieur



Sobald die Sonne untergeht, darf eine innovative Außenbeleuchtung nicht fehlen. Ein gut beleuchteter Außenbereich bietet nicht nur Sicherheit, sondern dient der Orientierung und schafft Atmosphäre rund um Ihr zu Hause. Außenleuchten sollten hohe Qualitätsanforderungen erfüllen, um den unterschiedlichen Bedingungen wie Feuchtigkeit, Regen, Schnee sowie jahreszeitlich bedingten Temperaturschwankungen unbeschadet standzuhalten. Unsere Außenleuchten werden in hochwertigem Aluminium-Druckguss gefertigt und versprechen Betriebssicherheit während der gesamten Lebensdauer, bei jeder Witterung, 365 Tage im Jahr. Moderne LED-Technologie sorgt darüber hinaus für gute Beleuchtungsqualität und hohe Energieeffizienz. Wir wünschen Ihnen viel Freude mit unser neuen Outdoor-Kollektion.

As soon as the sun goes down innovative outside lighting is a must. Well lit outdoor areas do not only provide security, but are an orientation guide and create atmosphere around your home. Outdoor lighting should fulfil high quality standards to withstand diverse conditions such as dampness, rain, snow and seasonal variations in temperature. Our outdoor lamps are produced in high-quality diecast aluminium and promise operational reliability for their entire life cycle, in all weathers, 365 days a year. Modern LED technology also provides a high level of both light quality and

sont fabriqués en aluminium moulé sous pression de haute qualité et garantissent une sécurité de fonctionnement pendant toute leur durée de vie, par tous les temps, 365 jours par an. La technologie LED moderne assure en outre une bonne qualité d'éclairage et une haute efficacité énergétique. Nous vous souhaitons beaucoup de satisfaction avec notre nouvelle collection d'extérieur.

Zodra de zon ondergaat, mag een innovatieve buitenverlichting niet ontbreken. Een goed verlichte buitenzone biedt niet alleen veiligheid, maar is goed voor de oriëntatie en scheidt sfeer rond uw huis. Buitenlichten moeten voldoen aan hoge kwaliteitsvereisten om bestand te zijn tegen diverse omstandigheden zoals vocht, regen, sneeuw alsook van het seizoen afhingende temperatuurschommelingen. Onze buitenlichten worden uit hoogwaardig aluminium gegoten en beloven een veilige werking tijdens hun volledige levensduur, bij alle weersomstandigheden, 365 dagen per jaar. Moderne ledtechnologie zorgt daarnaast voor een goede verlichtingskwaliteit en hoge energie-efficiëntie. We wensen u veel plezier met onze nieuwe collectie voor buiten.

Tan pronto como se pone el sol, no debe faltar una iluminación exterior innovadora. Una zona exterior bien iluminada no solo ofrece seguridad, sino que también

sirve para orientarse y crean una atmósfera alrededor de tu casa. La iluminación exterior debe cumplir unos altos requisitos de calidad para soportar las diferentes condiciones de humedad, lluvia y nieve, así como las condiciones estacionales de oscilación de temperaturas. Nuestra iluminación exterior está fabricada en aluminio fundido a presión de alta calidad y aseguran la seguridad operativa durante toda su vida, en cualquier clima, 365 días al año. La moderna tecnología LED proporciona también una iluminación de buena calidad y una gran eficiencia energética. Le deseamos una gran satisfacción con nuestra nueva colección de exterior.



Non appena il sole tramonta, l'illuminazione esterna innovativa è un must. Un'area esterna ben illuminata non solo garantisce la sicurezza ma funge anche da mezzo di orientamento e crea una piacevole atmosfera intorno alla vostra casa. Le lampade per esterni devono soddisfare elevati requisiti in termini di qualità per resistere, senza subire danni, alle varie condizioni climatiche come umidità, pioggia, neve e fluttuazioni stagionali della temperatura. Le nostre lampade per esterni sono prodotte in alluminio pressofuso di alta qualità e garantiscono affidabilità operativa durante tutto il loro ciclo di vita, in qualsiasi condizione atmosferica, 365 giorni all'anno. La moderna tecnologia LED garantisce inoltre una buona qualità dell'illuminazione e un'elevata efficienza energetica. Vi auguriamo il massimo del piacere con la nostra nuova Collezione Outdoor.

De îndată ce soarele apune, un sistem inovator de iluminat exterior nu trebuie să lipsească. Un spațiu exterior bine iluminat nu oferă numai securitate, ci are și rolul de a asigura orientarea și de a crea o atmosferă plăcută în jurul casei. Lămpile exterioare trebuie să îndeplinească cerințe înalte de calitate, pentru a rezista fără deteriorări la acțiunea diferitelor condiții de mediu, precum umiditatea, ploaia, ninsoarea, precum și fluctuațiile sezoniere de temperatură. Lămpile noastre exterioare sunt produse din aluminiu turnat sub presiune

și garantează siguranța în operare pe parcursul întregii durate de exploatare, în orice condiții meteo, timp de 365 de zile pe an. Tehnologia LED modernă asigură suplimentar o calitate bună a iluminatului și o eficiență energetică înaltă. Vă dorim să vă bucurați de colecția noastră outdoor.

Kun aurinko laskee, ei innovatiiviseen ulkovalaistukseen pitäisi tarvita puuttua. Hyvin valaistu ulkoalue tarjoaa turvallisuuden lisäksi myös kulkureittien ohjausta ja luo tunnelmaa kodin ympärille. Ulkovalaisimien on täytettävä

korkeat laatuvaatimukset, jotta ne kestävät erilaisia olosuhteita, kuten kosteutta, sadetta, lunta ja vuodenaikojen lämpötilanvaihteluita ilman vaurioita. Ulkovalaisimet valmistetaan korkealaatuisesta painevalelusta alumiinista, ja ne takaavat varman toiminnan koko käyttöikänsä ajan säästä riippumatta, 365 päivää vuodessa. Moderni LED-tekniikka varmistaa myös hyvän valaistuksen laadun ja korkean energiatehokkuuden. Toivomme, että uusi ulkovalaisinmallistomme tuottaa sinulle paljon iloa.

Gdy tylko zachodzi słońce, nie powinno zabraknąć innowacyjnego oświetlenia zewnętrznego. Dobrze oświetlone miejsce na zewnątrz nie tylko zapewnia bezpieczeństwo, ale także służy orientacji w terenie i tworzy atmosferę wokół domu. Oświetlenie zewnętrzne powinno spełniać wysokie wymagania jakościowe, aby bez uszkodzeń sprostać różnym warunkom, tj. wilgoć, deszcz, śnieg i sezonowe wahania temperatury. Nasze lampy zewnętrzne są produkowane z wysokiej jakości odlewanej aluminium i zapewniają niezawodność działania przez cały okres użytkowania, bez względu na pogodę, 365 dni w roku. Nowoczesna technologia LED zapewnia również dobrą jakość oświetlenia i wysoką efektywność energetyczną. Życzymy Państwu wiele radości z korzystania z naszej nowej kolekcji oświetlenia zewnętrznego.



# Serienübersicht · Family overview

Aperçu par famille · Overzicht per familie · Vista general por familia · Panoramica per famiglia ·  
Prezentare pe familii de produse · Perheen yleiskuvaus · Przegląd rodziny



ADAJA	61	PECOS	49	ARUBA	166
ADOUR	62	PIAVE	53	BOLO	168
ARDAS	70	RENO	22	BONITO	132
ARDILA	78	RHINE	34	CALERA	141
AVISIO	64	ROYA	74	CAMARO	144
AVON	26	SALMON	20	CAMPUS	185
BELAJA	122	SAMBESI	102	CORDOBA	134
BELLY	66	SANTERNO	69	DORA	162
BREG	48	TANARO	111	ELLIOT	156
BRENTA	109	TAWA	67	ESQUEL	176
CAVADO	100	TAY	58	FERNANDEZ	154
CLYDE	68	THAMES	60	FOMOSA	178
COLORADO	59	THAMES II	56	FUNGO	150
COOPER	84	TIBER	72	GARCIA	181
CUANDO	42	TIMOK	50	JAMAICA	167
CUBANGO	98	TRENT	54	KENDAL	145
DAWSON	36	TUELA	113	LENNON	157
DUERO	112	TUNGA	73	LIMEIRA	137
ELVO	118	UBANGI	120	LORA	163
FUERTE	18	VOLTURNO	114	MARTINEZ	158
GANGES	24	WITHAM	16	MELO	186
GARONNE	82	YANGTZE	44	MENDOZA	178
HONDO	52			MINEROS	182
HOOSIC	86			MOLINA	136
HORTON	40			MORENA	143
HUDSON	96			PALMAS	164
INDUS	51			PALOMA	128
KANSAS	41			POSADAS	174
KASAI	47			PUELO	140
KAVERI	71			PUNO	138
KONDA	45			RICARDO	152
LIVENZA	116			ROSARIO	135
LUNGA	106			SALTA	179
MAREB	121			SANCHEZ	160
MARIZA	12			SANTANA	184
MARNE	38			SILVA	180
MAYENNE	55			SUAREZ	148
MERSEY	46			TORREZ	159
NELSON	32			VENADO	142
NESTOS	14				
NORMAN	108				
OHIO	43				
OLONA	110				
PEARL	28				

# Produktübersicht · Product Overview

Aperçu des produits · Productoverzicht · Descripción del producto ·

Panoramica prodotto · Vizualizare produs · Tuotteen yleiskuvaus · Przegląd produktów



MARIZA  
12



DAWSON  
36



MARNE  
38



AVON  
26



FUERTE  
18



RHINE  
34



WITHAM  
16



CALERA  
141



PUELO  
140



NELSON  
32



GANGES  
24



PEARL  
30



TAWA  
67



NESTOS  
14



YANGTZE  
44



CUANDO  
42



HORTON  
40



KANSAS  
41



THAMES  
60



THAMES II  
56



SALMON  
20



TRENT  
54



ADOUR  
62



COLORADO  
59



TAY  
58



SANTERO  
69



MAYENNE  
55



RENO  
22



COOPER  
84



CLYDE  
68



ROYA  
76

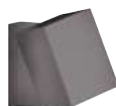

TIBER  
72



KAVERI  
71



TUNGA  
73



ADAJA  
61



CORDOBA  
134



ROSARIO  
135



ARDAS  
70



AVISIO  
64



PUNO  
138



ARDILA  
78



ARDILA  
80



HOOSIC  
92



HOOSIC  
88



HUDSON  
96



MOLINA  
136



MOLINA  
136



LIMEIRA  
137



BONITO  
132



PALOMA  
130



GARONNE  
82



INDUS  
51



TIMOK  
50



PECOS  
49



KONDA  
45



KENDAL  
145



BELLY  
66



HONDO  
52



BREG  
48



KENDAL  
145



CAMARO  
144



VENADO  
142



MORENA  
143



CUBANGO  
98



TUELA  
113



GARONNE  
82

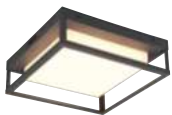

WITHAM  
16



SAMBESI  
102



TANARO  
111



LUNGA  
106



OLONA  
110



CAVADO  
100



DUERO  
112



BRENTA  
109



ELVO  
118



VOLTURNO  
114



LIVENZA  
116



MARIZA  
12



WITHAM  
16



FUERTE  
18



RHINE  
34



PEARL  
30



AVON  
26



SALMON  
20



ROYA  
76



NELSON  
32



KAVERI  
71



GANGES  
24



RENO  
22



COOPER  
84



HOOSIC  
92



HOOSIC  
88



PALOMA  
130



ARDILA  
80



ARDILA  
78



GARONNE  
82



HUDSON  
96



SAMBESI  
102



CUBANGO  
98



CAVADO  
100



ELVO  
118



VOLTURNO  
114



LIVENZA  
116



# Sicherheit & Komfort / Sensorleuchten · Security & Comfort / Sensor Lights

Sécurité et confort / Lampes à détecteur · Veiligheid en comfort/sensorlampen · Seguridad & Comodidad / Luces del sensor ·  
Sicurezza e comfort / Lampade con sensore integrat · Siguranță & confort / Lumini senzor ·  
Turvallisuus ja mukavuus/tunnistinvalaisimet · Bezpieczeństwo i komfort / światła z czujnikami



AVON  
27



NESTOS  
14



RHINE  
34



GANGES  
25



NELSON  
33



PEARL  
28



HORTON  
41



ROYA  
74



ROYA  
74



TUNGA  
73



CUANDO  
42



OHIO  
43



ADOUR  
62



HOOSIC  
90



HOOSIC  
86



NORMAN  
108



KASAI  
47



PIAVE  
53



NESTOS  
14



ROYA  
74



PEARL  
28



HOOSIC  
90



HOOSIC  
86



PALOMA  
128



GARONNE  
83



GARONNE  
83



SALMON  
20



MARIZA  
12



KANSAS  
41



BONITO  
132



PALOMA  
128



SAMBESI  
105



CAVADO  
100



TUELA  
113

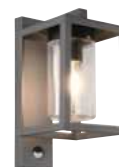

LUNGA  
106



MERSEY  
46

## Spots, Einbauleuchten & Zubehör ·

## Spotlights, Recessed luminaires & Accessories

Spots, lumières encastrées et accessoires · Spots, inbouwlampen en toebehoren · Puntos de luz, lámparas integradas y accesorios · Faretto, lampade da incasso e sensori · Spoturi, lămpi încorporate & accesorii · Kohdevalaisimet, upotettavat valaisimet ja tarvikkeet · Spoty, światła wpuszczane i akcesoria



BELAJA  
122



MAREB  
121



UBANGI  
120



ERDSPIESS  
GROUND SPIKE  
124



ECKHALTERUNG  
CORNER FASTENING  
125



STECKDOSEN  
PLUG  
123



STECKDOSEN  
PLUG  
123

## Outdoor Living · Outdoor Living Lighting

Idées d'éclairage pour la vie en plein air · Lichtideeën voor buiten · Ideas de luz para la vida al aire libre · Idee di Illuminazione per l'Outdoor Living · Idei de iluminare pentru exterior · Outdoor Living -valaisinideat · Pomysły na oświetlenie zewnętrzne



ARUBA  
166



JAMAICA  
167



PALMAS  
164



DORA  
162



LORA  
163



FUNGO  
150



SUAREZ  
148



TORREZ  
159



RICARDO  
152



ELLIOT  
156



LENNON  
157



SANCHEZ  
160



FERNANDEZ  
154



MARTINEZ  
158



BOLO  
170



BOLO  
168

# Solarleuchten · Solar Lights

Lampes solaires · Lampen op zonne-energie · Luces solares ·  
Lampade solari · Lāmpi solare · Aurinkovalaisimet · Światła z zasilaniem słonecznym



POSADAS  
174



ESQUEL  
176



FOMOSA  
178



MENDOZA  
178



SALTA  
179



POSADAS  
174



ESQUEL  
176



SILVA  
180



GARCIA  
181



MINEROS  
182



SANTANA  
184



MELO  
186



CAMPUS  
185

# MARIZA

Aluminium Druckguss, Glas  
 diecast aluminium, glass  
 fonte d'aluminium, verre  
 gegoten aluminium, glas  
 aluminio fundido, vidrio  
 pressofusione di alluminio, vetro  
 fonta aluminiu, sticla  
 valualumiini, lasi  
 barwione aluminium, szkło

**42 Anthrazit · anthracite**

Incl. 1 x SMD-LED, 10 W  
 1.100 lm, 3.000 K

**247069142**



Incl. 1 x SMD-LED, 10 W  
 1.100 lm, 3.000 K

**247060142**

Incl. 1 x SMD-LED, 16 W  
 1.800 lm, 3.000 K

**447060142**

Incl. 1 x SMD-LED, 11 W  
 1.150 lm, 3.000 K

**547060142**

**IP44**



**247069142**



**247060142**



**547060142**



**447060142**

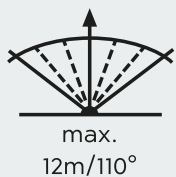
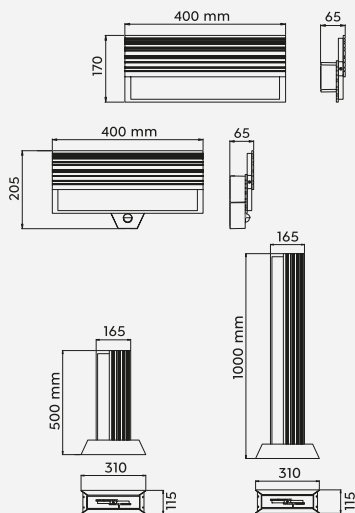

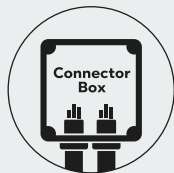

Inkl. Verbinder für Reihenschaltung.

Der Anschlusskasten dieser Leuchte ist für die Aufnahme von zwei Erdzu-  
leitungen geeignet, um mehrere Leuchten in Reihenschaltung zu verbinden.

Connector for series connection included.

The connection box of this lighting fixture is fit for mounting two supply cables  
in order to connect several luminaires in series.

# NESTOS

Aluminium Druckguss, Kunststoff  
 diecast aluminium, plastic  
 fonte d'aluminium, plastique  
 gegoten aluminium, kunststof  
 aluminio fundido, plástico  
 pressofusione di alluminio, plastica  
 fonta aluminu, plastic  
 valualumiini, muovi  
 barwione aluminium, plastik

**42** Anthrazit · anthracite

Incl. 1 x SMD-LED, 13 W  
 1.300 lm, 3.000 K

**240960142**

**IP54**

Incl. 1 x SMD-LED, 13 W  
 1.300 lm, 3.000 K

**240969142**

**440969142**

**540969142**

**IP54** 



**240960142**



**240969142**



**440969142**



**540969142**

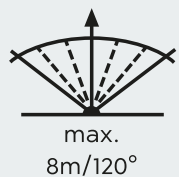
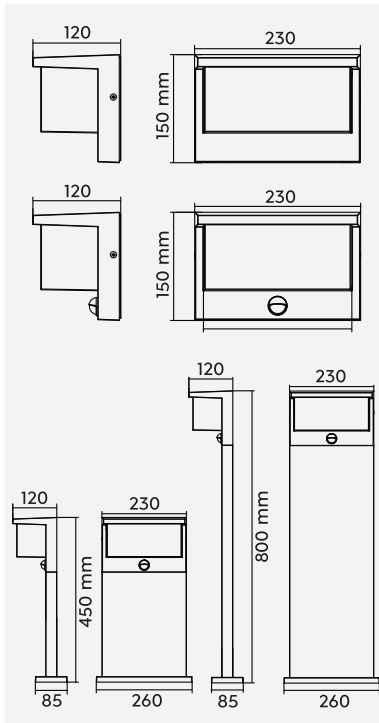



Aluminium Druckguss  
diecast aluminium  
fonte d'aluminium  
gegoten aluminium  
aluminio fundido  
pressofusione di alluminio  
fonta aluminiu  
valualumiini  
barwione aluminium

**42 Anthrazit · anthracite**

Incl. 1 x SMD-LED, 10,5 W  
1.100 lm, 2.300 + 3.000 + 4.000 K  
**277860142**

Incl. 1 x SMD-LED, 14 W  
1.550 lm, 2.300 + 3.000 + 4.000 K  
**677860142**



Incl. 1 x SMD-LED, 14,5 W  
1.450 lm, 2.300 + 3.000 + 4.000 K  
**477860142**  
**577860142**



**677860142**



**277860142**



**477860142**



**577860142**

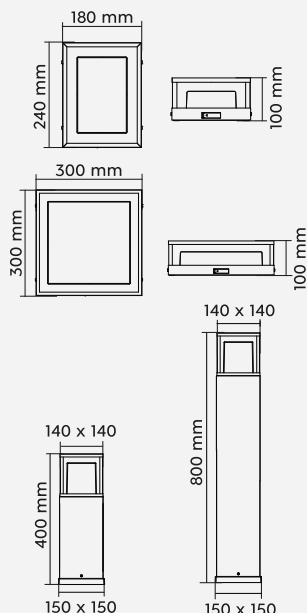

## DIP SWITCH

Lichtfarben direkt an der Leuchte einstellbar

Colours directly adjustable at the lamp

Les couleurs de la lumière peuvent être réglées directement sur le luminaire

Lichtkleuren direct instelbaar op de lamp

Tonalidades de luz ajustables directamente en la lámpara

Colori della luce regolabili direttamente sulla lampada

Colori ale luminii reglabile direct de la bec

Valon väri asetettävissa suoraan valaisimesta

Barwy światła można ustawić bezpośrednio na oprawie

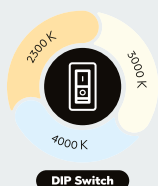



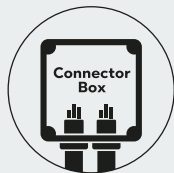

Inkl. Verbinder für Reihenschaltung.

Der Anschlusskasten dieser Leuchte ist für die Aufnahme von zwei Erdzu-  
leitungen geeignet, um mehrere Leuchten in Reihenschaltung zu verbinden.

Connector for series connection included.

The connection box of this lighting fixture is fit for mounting two supply cables  
in order to connect several luminaires in series.

# FUERTE

Aluminium Druckguss, Acryl  
diecast aluminium, acryl  
fonte d'aluminium, acryl  
gegoten aluminium, acryl  
aluminio fundido, acrílico  
pressofusione di alluminio, acrilico  
fonta aluminiu, acrilic  
valualumiini, akryyli  
barwione aluminium, akryl

**42** Anthrazit · anthracite

Incl. 1 x SMD-LED, 10,5 W  
1.300 lm, 3.000 K

**226260142**

**IP54**

Incl. 1 x SMD-LED, 15 W  
1.700 lm, 3.000 K

**426260142**

**526260142**

**IP54**



**226260142**



**426260142**



**526260142**

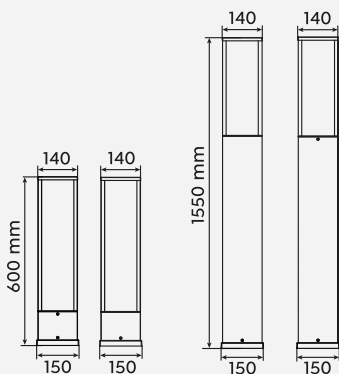
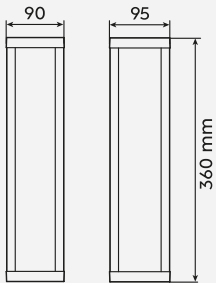



222

# SALMON

Aluminium Druckguss,  
Holznachbildung  
diecast aluminium, wood imitation  
fonte d'aluminium, imitation bois  
gegoten aluminium, houtimitatie  
aluminio fundido,  
imitación de madera  
pressofusione di alluminio,  
effetto legno  
fonta aluminiu, imitație de lemn  
valualumiini, puujäljitelmä  
barwione aluminium,  
imitacja drewna

**35** Holznachbildung / Anthrazit ·  
wood imitation / anthracite

Incl. 1 x SMD-LED, 11 W  
1.200 lm, 3.000 K

**246960135**



Incl. 1 x SMD-LED, 11 W  
1.200 lm, 3.000 K

**246960135**

**446960135**

**546960135**

**IP44**

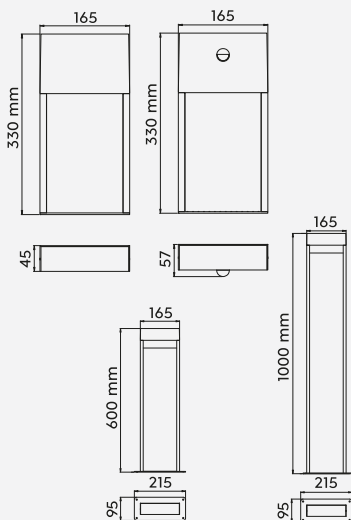

**246960135**



**246969135**



**446960135**



**546960135**

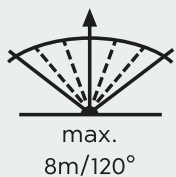

Bewegungssensor  
Motion sensor  
Décteur de mouvement  
Bewegingssensor  
Sensor de movimiento  
Sensore di movimento  
Senzor de mișcare  
Liiketunnistin  
Czujnik ruchu



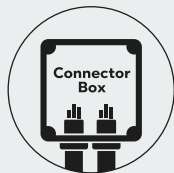

Inkl. Verbinder für Reihenschaltung.

Der Anschlusskasten dieser Leuchte ist für die Aufnahme von zwei Erdzu-  
leitungen geeignet, um mehrere Leuchten in Reihenschaltung zu verbinden.

Connector for series connection included.

The connection box of this lighting fixture is fit for mounting two supply cables  
in order to connect several luminaires in series.

# RENO

Aluminium Druckguss  
diecast aluminium  
fonte d'aluminium  
gegoten aluminium  
aluminio fundido  
pressofusione di alluminio  
fonta aluminu  
valualumiini  
barwione aluminium

**42** Anthrazit · anthracite

Incl. 1 x COB-LED, 4,5 W  
450 lm, 3.000 K

**IP54**

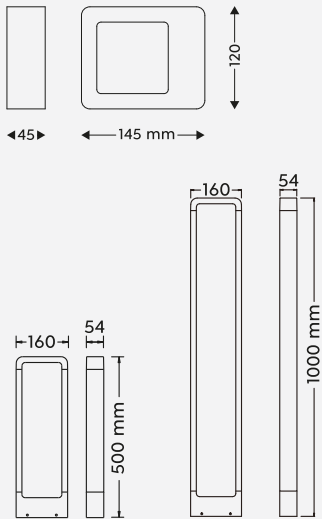

220760142



520760142

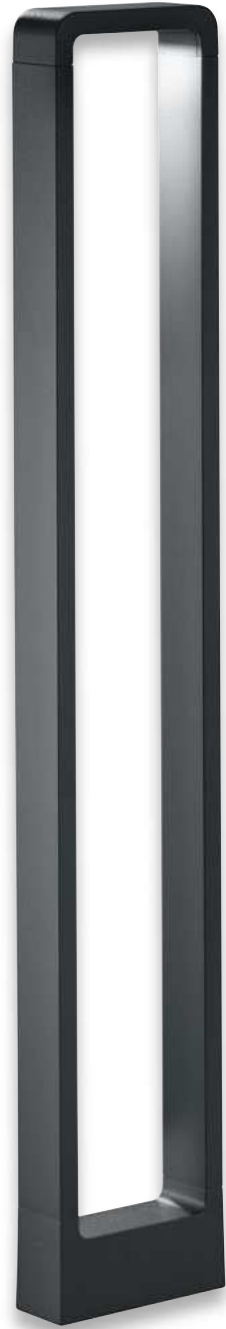

420760142

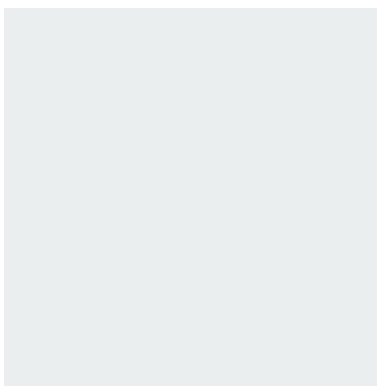



# GANGES

Aluminium Druckguss  
diecast aluminium  
fonte d'aluminium  
gegoten aluminium  
aluminio fundido  
pressofusione di alluminio  
fonta aluminii  
valualumiini  
barwione aluminium

**42** Anthrazit · anthracite

Incl. 1 x SMD-LED, 9 W  
1.000 lm, 3.000 K

**IP54**

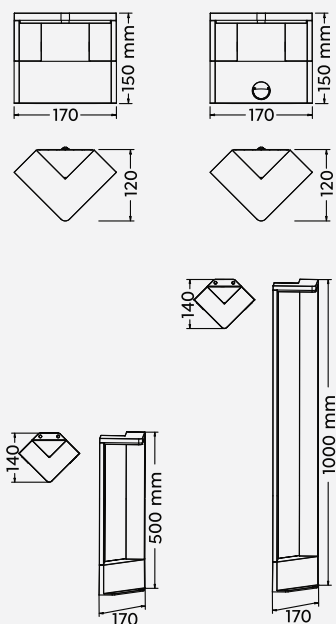

**221760142**



**521760142**



**421760142**







221769142



Bewegungssensor  
Motion sensor  
Détecteur de mouvement  
Bewegingssensor  
Sensor de movimiento  
Sensore di movimento  
Senzor de mișcare  
Liiketunnistin  
Czujnik ruchu

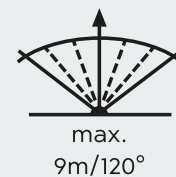

# AVON

Aluminium Druckguss, Acryl  
 diecast aluminium, acryl  
 fonte d'aluminium, acryl  
 gegoten aluminium, acryl  
 aluminio fundido, acrílico  
 pressofusione di alluminio, acrilico  
 fonta aluminiu, acrilic  
 valualumiini, akryyli  
 barwione aluminium, akryl

**42 Anthrazit · anthracite**

Incl. 1 x SMD-LED, 7 W  
 800 lm, 3.000 K

**270660142**  
**470660142**  
**570660142**



Incl. 2 x SMD-LED, 7 W  
 2 x 800 lm, 3.000 K

**270660242**



**270660142**



**270660242**



**570660142**



**470660142**

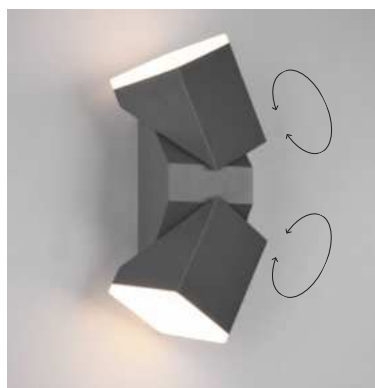
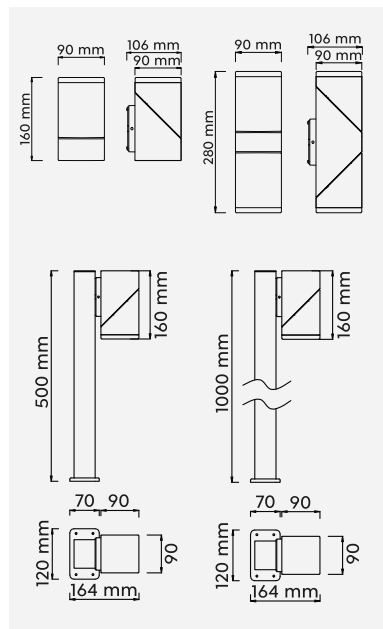



Aluminium Druckguss, Acryl  
 diecast aluminium, acryl  
 fonte d'aluminium, acryl  
 gegoten aluminium, acryl  
 aluminio fundido, acrílico  
 pressofusione di alluminio, acrilico  
 fonta aluminiu, acrilic  
 valualumiini, akryyli  
 barwione aluminium, akryl

**42 Anthrazit · anthracite**

Incl. 1 x SMD-LED, 7 W  
 800 lm, 3.000 K

**270669142**



Incl. 2 x SMD-LED, 7 W  
 2 x 800 lm, 3.000 K

**270669242**



**270669242**

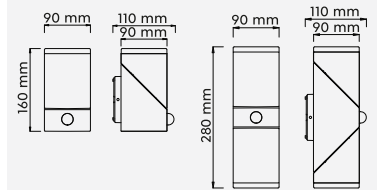

**270669142**

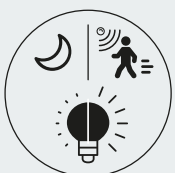

Die Leuchte verfügt über ein Orientierungslicht, das sich bei Dämmerung oder Dunkelheit automatisch einschaltet. Wird eine Bewegung erfasst, schaltet die Leuchte von Orientierungslicht auf volle Lichtleistung.

The luminaire has an orientation light that switches on automatically at dusk or in the dark. If movement is detected, the luminaire switches from orientation light to full light output.



max.  
 6m/100°

# PEARL

Aluminium Druckguss, Kunststoff  
 diecast aluminium, plastic  
 fonte d'aluminium, plastique  
 gegoten aluminium, kunststof  
 aluminio fundido, plástico  
 pressofusione di alluminio, plastica  
 fonta aluminiu, plastic  
 valualumiini, muov  
 barwione aluminium, plastik

**42** Anthrazit · anthacite

Incl. 1 x SMD-LED, 8 W  
 900 lm, 3.000 K



221169142



521169142



421169142

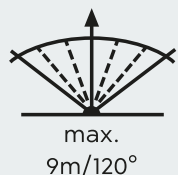
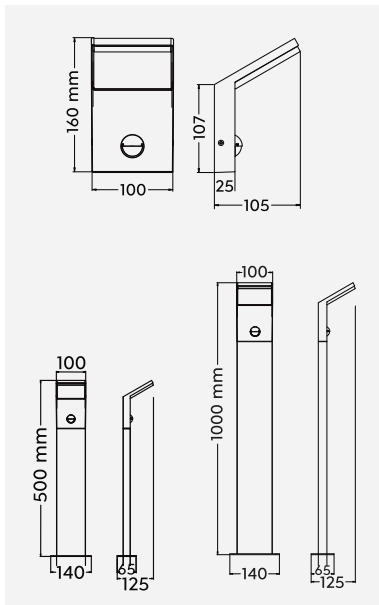

Bewegungssensor  
 Motion sensor  
 Détecteur de mouvement  
 Bewegungssensor  
 Sensor de movimiento  
 Sensore di movimento  
 Senzor de mişcare  
 Liiketunnistin  
 Czujnik ruchu





# PEARL

Aluminium Druckguss, Kunststoff  
diecast aluminium, plastic  
fonte d'aluminium, plastique  
gegoten aluminium, kunststof  
aluminio fundido, plástico  
pressofusione di alluminio, plastica  
fonta aluminiu, plastic  
valualumiini, muovi  
barwione aluminium, plastik

**42** Anthrazit · anthacite

Incl. 1 x SMD-LED, 8 W  
900 lm, 3.000 K

**IP54**

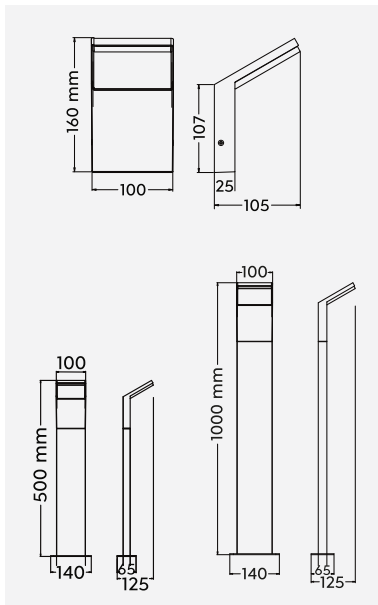

221160142



521160142



421160142





# NELSON

Aluminium Druckguss  
diecast aluminium  
fonte d'aluminium  
gegoten aluminium  
aluminio fundido  
pressofusione di alluminio  
fonta aluminii  
valualumiini  
barwione aluminium

**42** Anthrazit · anthracite

Incl. 1 x SMD-LED, 8 W  
900 lm, 3.000 K

**IP54**

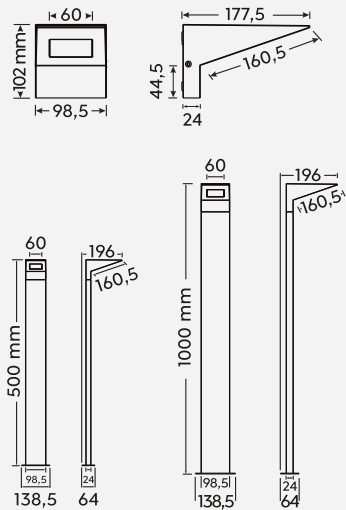

**225360142**



**525360142**



**425360142**

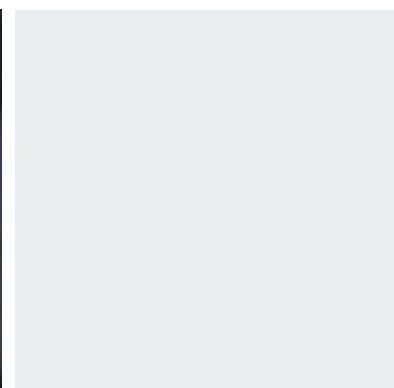



# NELSON

Aluminium Druckguss  
diecast aluminium  
fonte d'aluminium  
gegooten aluminium  
aluminio fundido  
pressofusione di alluminio  
fonta aluminiu  
valualumiini  
barwione aluminium

**42** Anthrazit · anthracite

Incl. 1 x SMD-LED, 8 W  
900 lm, 3.000 K

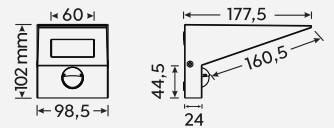

225369142



Bewegungssensor  
Motion sensor  
Décteur de mouvement  
Bewegingssensor  
Sensor de movimiento  
Sensore di movimento  
Senzor de mişcare  
Liiketunnistin  
Czujnik ruchu

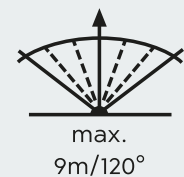

# RHINE

Aluminium Druckguss, Kunststoff  
 diecast aluminium, plastic  
 fonte d'aluminium, plastique  
 gegoten aluminium, kunststof  
 aluminio fundido, plástico  
 pressofusione di alluminio, plastica  
 fonta aluminiu, plastic  
 valualumiini, muov  
 barwione aluminium, plastik

**42** Anthrazit · anthracite

Incl. 2 x SMD-LED, 4,5 W  
 2 x 450 lm, 3.000 K

**221660242**

**221669242**

Incl. 2 x SMD-LED, 5,5 W  
 2 x 700 lm, 3.000 K

**421660242**

**521660242**

**IP54**



**221669242**



**221660242**



**521660242**



**421660242**

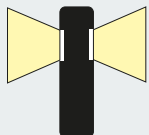
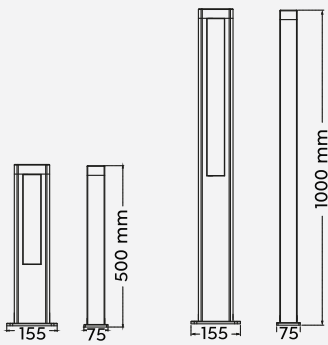
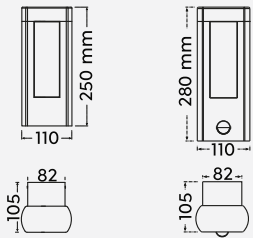



Bewegungssensor  
Motion sensor  
Détecteur de mouvement  
Bewegungssensor  
Sensor de movimiento  
Sensore di movimento  
Senzor de mișcare  
Liiketunnistin  
Czujnik ruchu

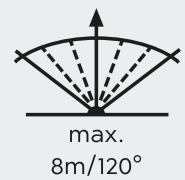

# DAWSON

Aluminium Druckguss, Acryl  
diecast aluminium, acryl  
fonte d'aluminium, acryl  
gegoten aluminium, acryl  
aluminio fundido, acrílico  
pressofusione di alluminio, acrilico  
fonta aluminiu, acrilic  
valualumiini, akryyli  
barwione aluminium, akryl

**42** Anthrazit · anthracite

Incl. SMD-LED, 7 W  
800 lm, 2.300 + 3.000 + 4.000 K  
**246360142**

Incl. SMD-LED, 8 W  
900 lm, 2.300 + 3.000 + 4.000 K  
**246360242**

Incl. SMD-LED, 11 W  
1.300 lm, 2.300 + 3.000 + 4.000 K  
**246360342**

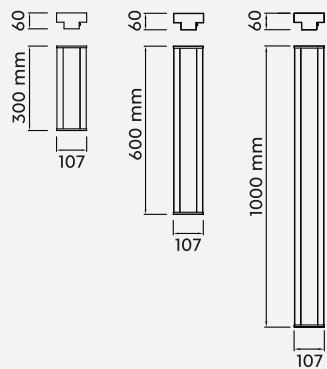

**246360142**



**246360342**

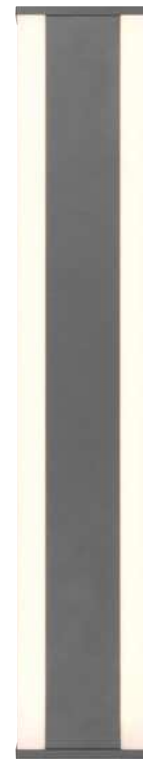

**246360242**

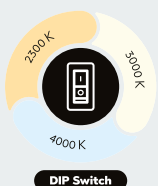

## DIP SWITCH

Lichtfarben direkt an der Leuchte einstellbar

Colours directly adjustable at the lamp

Les couleurs de la lumière peuvent être réglées directement sur le luminaire

Lichtkleuren direct instelbaar op de lamp

Tonalidades de luz ajustables directamente en la lámpara

Colori della luce regolabili direttamente sulla lampada

Colori ale luminii reglabile direct de la bec

Valon väri asetettävissa suoraan valaisimesta

Barwy światła można ustawić bezpośrednio na oprawie



# MARNE

Aluminium Druckguss, Acryl  
diecast aluminium, acryl  
fonte d'aluminium, acryl  
gegoten aluminium, acryl  
aluminio fundido, acrílico  
pressofusione di alluminio, acrilico  
fonta aluminiu, acrilic  
valualumiini, akryyli  
barwione aluminium, akryl

**42** Anthrazit · anthracite

Incl. SMD-LED, 5,5 W  
600 lm, 3.000 K

**247360142**

Incl. SMD-LED, 8,5 W  
1.000 lm, 3.000 K

**247360242**

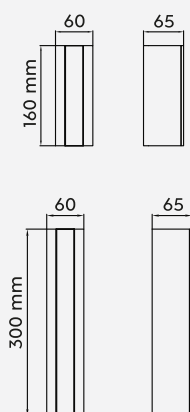

**247360142**

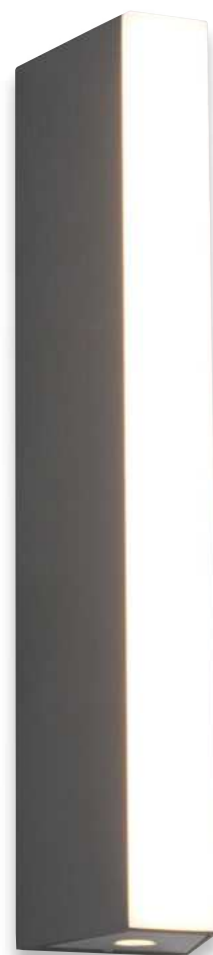

**247360242**

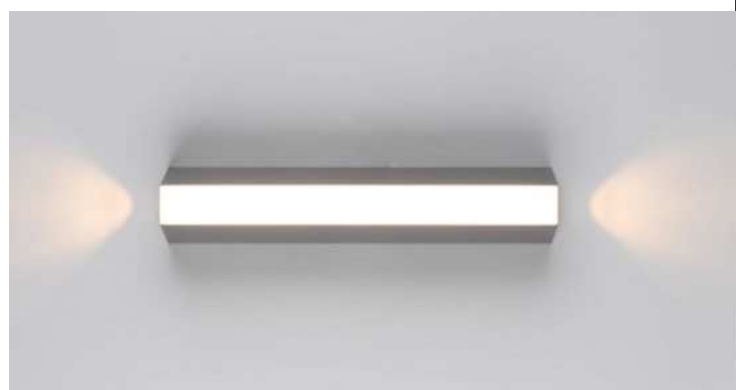



# HORTON

Aluminium Druckguss  
 diecast aluminium  
 fonte d'aluminium  
 gegoten aluminium  
 aluminio fundido  
 pressofusione di alluminio  
 fonta aluminiu  
 valualumiini  
 barwione aluminium

**42 Anthrazit · anthracite**

Incl. 1 x SMD-LED, 8 W  
 1.000 lm, 3.000 K

**226360142**



Incl. 1 x SMD-LED, 8 W  
 1.000 lm, 3.000 K

**226369142**

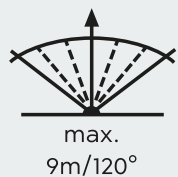
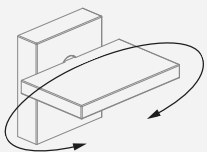
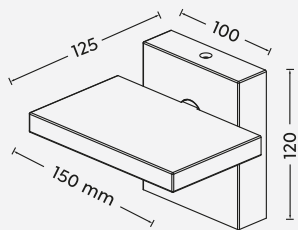

Bewegungssensor  
 Motion sensor  
 Détecteur de mouvement  
 Bewegungssensor  
 Sensor de movimiento  
 Sensore di movimento  
 Senzor de mişcare  
 Liiketunnistin  
 Czujnik ruchu





# KANSAS



Aluminium Druckguss, Acryl  
diecast aluminium, acryl  
fonte d'aluminium, acryl  
gegoten aluminium, acryl  
aluminio fundido, acrílico  
pressofusione di alluminio, acrilico  
fonta aluminiu, acrilic  
valualumiini, akryyli  
barwione aluminium, akryl

**42** Anthrazit · anthracite

Incl. 1 x SMD-LED, 10 W  
1.000 lm, 3.000 K

**246860142**



Incl. 1 x SMD-LED, 10 W  
1.000 lm, 3.000 K

**246869142**

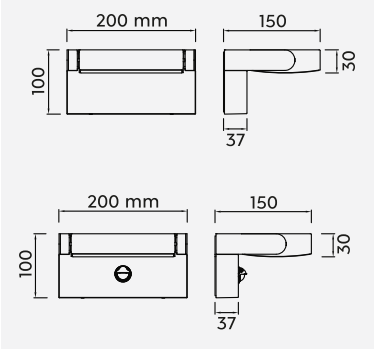

**246860142**



Bewegungssensor  
Motion sensor  
Détecteur de mouvement  
Bewegingssensor  
Sensor de movimiento  
Sensore di movimento  
Senzor de mișcare  
Liiketunnistin  
Czujnik ruchu

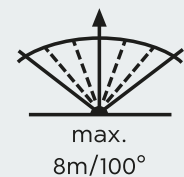

# CUANDO

Aluminium Druckguss, Acryl  
diecast aluminium, acryl  
fonte d'aluminium, acryl  
gegoten aluminium, acryl  
aluminio fundido, acrílico  
pressofusione di alluminio, acrilico  
fonta aluminiu, acrilic  
valualumiini, akryyli  
barwione aluminium, akryl

**42** Anthrazit · anthracite

Incl. SMD-LED, 11 W  
1.400 lm, 3.000 K

**226660242**



Incl. SMD-LED, 11 W  
1.400 lm, 3.000 K

**226669242**

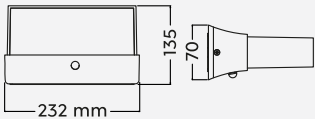
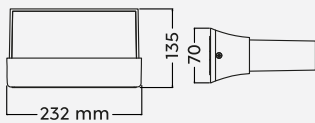

**226660242**



**226669242**

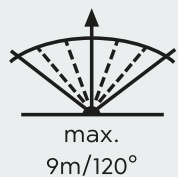

max.  
9m/120°



Bewegungssensor  
Motion sensor  
Détecteur de mouvement  
Bewegungssensor  
Sensor de movimiento  
Sensore di movimento  
Senzor de mișcare  
Liiketunnistin  
Czujnik ruchu

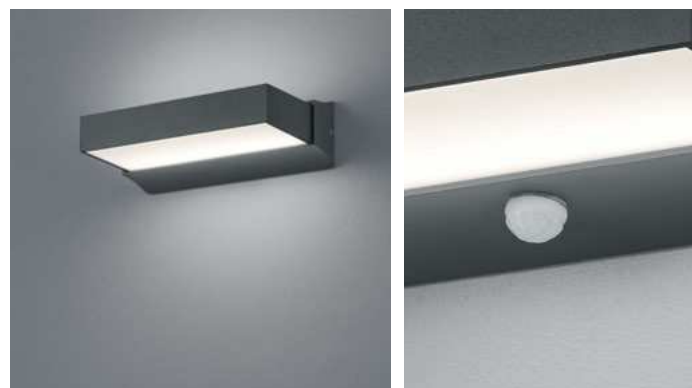

Aluminium Druckguss, Kunststoff  
 diecast aluminium, plastic  
 fonte d'aluminium, plastique  
 gegoten aluminium, kunststof  
 aluminio fundido, plástico  
 pressofusione di alluminio, plastica  
 fonta aluminiu, plastic  
 valualumiini, muovi  
 barwione aluminium, plastik

**42** Anthrazit · anthracite

Incl. 1 x SMD-LED, 7,5 W  
 800 lm, 3.000 K

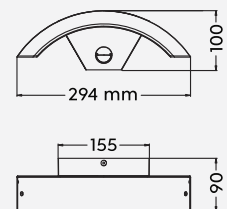

220969142



Bewegungssensor  
 Motion sensor  
 Détecteur de mouvement  
 Bewegungssensor  
 Sensor de movimiento  
 Sensore di movimento  
 Senzor de mișcare  
 Liiketunnistin  
 Czujnik ruchu

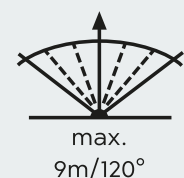

# YANGTZE

Aluminium Druckguss, Kunststoff  
diecast aluminium, plastic  
fonte d'aluminium, plastique  
gegoten aluminium, kunststof  
aluminio fundido, plástico  
pressofusione di alluminio, plastica  
fonta aluminiu, plastic  
valualumiini, muovi  
barwione aluminium, plastik

**42** Anthrazit · anthracite

Incl. 1 x SMD-LED, 4,5 W  
400 lm, 3.000 K

IP54

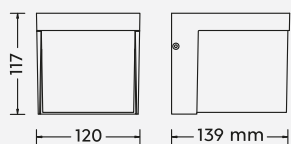

228260142



# KONDA

Aluminium Druckguss, Kunststoff  
diecast aluminium, plastic  
fonte d'aluminium, plastique  
gegoten aluminium, kunststof  
aluminio fundido, plástico  
pressofusione di alluminio, plastica  
fonta aluminiu, plastic  
valualumiini, muovi  
barwione aluminium, plastik

**42** Anthrazit · anthracite

Incl. 1 x SMD-LED, 9 W  
1.200 lm, 3.000 K

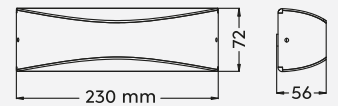

**228560242**



# MERSEY

Aluminium Druckguss, Kunststoff  
diecast aluminium, plastic  
fonte d'aluminium, plastique  
gegoten aluminium, kunststof  
aluminio fundido, plástico  
pressofusione di alluminio, plastica  
fonta aluminiu, plastic  
valualumiini, muovi  
barwione aluminium, plastik

**42** Anthrazit · anthracite

Excl. 2 x E14, max. 40 W

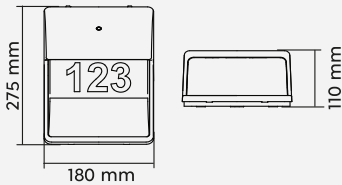

212160242



Empfohlen:  
recommended:

LED E14, 3,5 W  
320 lm, 3.000 K



983-40



Dämmerungssensor  
Dusk sensor  
Décteur de crépuscule  
Schemeringsensor  
Sensor de oscuridad  
Sensore crepuscolare  
Senzor de lumina/amurg  
Hämärätunnistin  
Czujnik zmierzchowy

# KASAI

Aluminium Druckguss, Kunststoff  
diecast aluminium, plastic  
fonte d'aluminium, plastique  
gegoten aluminium, kunststof  
aluminio fundido, plástico  
pressofusione di alluminio, plastica  
fonta aluminiu, plastic  
valualumiini, muovi  
barwione aluminium, plastik

**42** Anthrazit · anthracite

Incl. 1 x SMD-LED, 9 W  
850 lm, 3.000 K

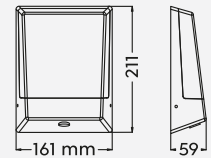

228669142



Dämmerungssensor  
Dusk sensor  
Décteur de crépuscule  
Schemeringsensor  
Sensor de oscuridad  
Sensore crepuscolare  
Sensor de lumina/amurg  
Hämärätunnistin  
Czujnik zmierzchowy  
Alacakaranlık Algılayıcısı

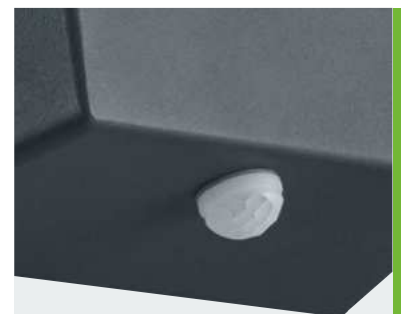

Aluminium Druckguss, Kunststoff  
diecast aluminium, plastic  
fonte d'aluminium, plastique  
gegoten aluminium, kunststof  
aluminio fundido, plástico  
pressofusione di alluminio, plastica  
fonta aluminiu, plastic  
valualumiini, muovi  
barwione aluminium, plastik

**42** Anthrazit · anthracite

Incl. 1 x SMD-LED, 8,5 W  
850 lm, 3.000 K

IP54

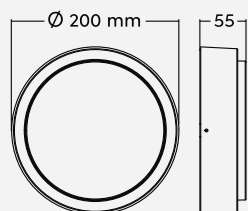

227260142





# PECOS

Aluminium Druckguss, Kunststoff  
diecast aluminium, plastic  
fonte d'aluminium, plastique  
gegooten aluminium, kunststof  
aluminio fundido, plástico  
pressofusione di alluminio, plastica  
fonta aluminiu, plastic  
valualumiini, muovi  
barwione aluminium, plastik

**42** Anthrazit · anthracite

Incl. 1 x SMD-LED, 6 W  
600 lm, 3.000 K

**IP54**

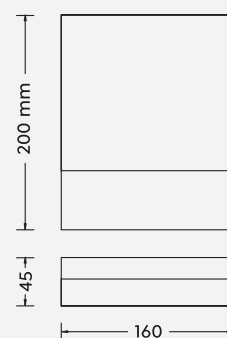

**227760142**

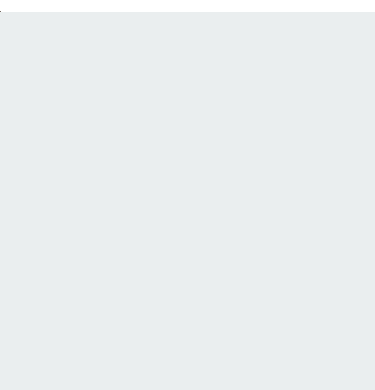

# TIMOK

Aluminium Druckguss, Kunststoff  
diecast aluminium, plastic  
fonte d'aluminium, plastique  
gegoten aluminium, kunststof  
aluminio fundido, plástico  
pressofusione di alluminio, plastica  
fonta aluminiu, plastic  
valualumiini, muovi  
barwione aluminium, plastik

**42** Anthrazit · anthracite

Incl. 1 x LED E27, 4,9 W  
470 lm, 3.000 K

IP54

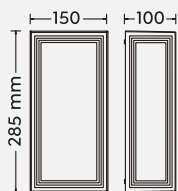

228060142



# INDUS

Aluminium Druckguss, Kunststoff  
diecast aluminium, plastic  
fonte d'aluminium, plastique  
gegoten aluminium, kunststof  
aluminio fundido, plástico  
pressofusione di alluminio, plastica  
fonta aluminiu, plastic  
valualumiini, muovi  
barwione aluminium, plastik

**42** Anthrazit · anthracite

Incl. 2 x SMD-LED, 4 W  
2 x 500 lm, 3.000 K

IP54

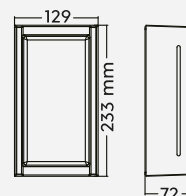

227360142



# HONDO

Aluminium Druckguss, Kunststoff  
diecast aluminium, plastic  
fonte d'aluminium, plastique  
gegoten aluminium, kunststof  
aluminio fundido, plástico  
pressofusione di alluminio, plastica  
fonta aluminiu, plastic  
valualumiini, muovi  
barwione aluminium, plastik

**42** Anthrazit · anthracite

Incl. 1 x SMD-LED, 3,5 W  
330 lm, 3.000 K

IP54

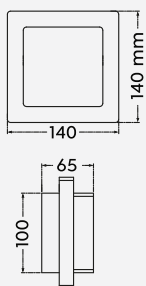

**228960142**



# PIAVE



Kunststoff  
plastic  
plastique  
kunststof  
plástico  
plastica  
plastic  
muovi  
plastik

**31** Weiß matt · white mat

**42** Anthrazit · anthracite

Incl. SMD-LED, 11 W  
1.180 lm, 3.000 K

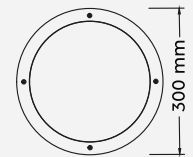

676960131



676960142



Bewegungssensor  
Motion sensor  
Détecteur de mouvement  
Bewegingssensor  
Sensor de movimiento  
Sensore di movimento  
Senzor de mișcare  
Liiketunnistin  
Czujnik ruchu

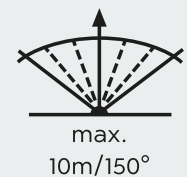

# TRENT

Aluminium Druckguss  
diecast aluminium  
fonte d'aluminium  
gegoten aluminium  
aluminio fundido  
pressofusione di alluminio  
fonta aluminiu  
valualumiini  
barwione aluminium

**31** Weiß matt · white mat

**42** Anthrazit · anthracite

Incl. SMD-LED, 9 W  
1.100 lm, 3.000 K

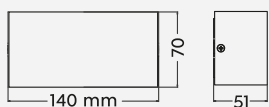

**226960231**



**226960242**

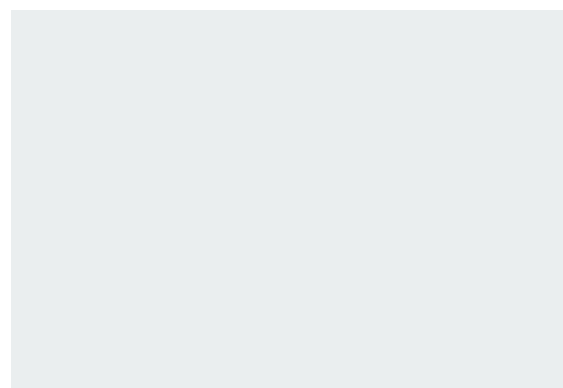

# MAYENNE

Aluminium Druckguss, Acryl  
diecast aluminium, acryl  
fonte d'aluminium, acryl  
gegoten aluminium, acryl  
aluminio fundido, acrílico  
pressofusione di alluminio, acrilico  
fonta aluminiu, acrilic  
valualumiini, akryyli  
barwione aluminium, akryl

**35** Holznachbildung · wood imitation

**42** Anthrazit · anthracite

Excl. 2 x E14, max. 28 W

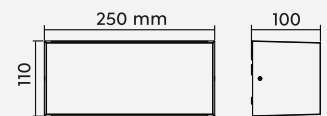

218560242



218560235

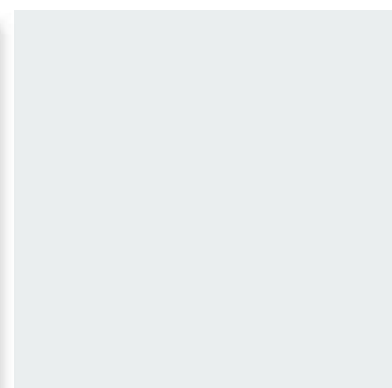

# THAMES II

Aluminium Druckguss  
diecast aluminium  
fonte d'aluminium  
gegoten aluminium  
aluminio fundido  
pressofusione di alluminio  
fonta aluminii  
valualumiini  
barwione aluminium

**31** Weiß matt · white mat

**42** Anthrazit · anthracite

Incl. 2 x SMD-LED, 2,5 W  
2 x 260 lm, 3.000 K

**227560231**

**227560242**

Incl. 2 x SMD-LED, 4,5 W  
2 x 450 lm, 3.000 K

**227660231**

**227660242**

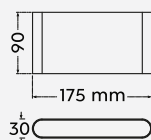
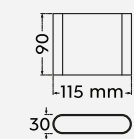

**227560231**



**227560242**



**227660231**



**227660242**





# THAMES II

Aluminium Druckguss  
diecast aluminium  
fonte d'aluminium  
gegoten aluminium  
aluminio fundido  
pressofusione di alluminio  
fonta aluminiu  
valualumiini  
barwione aluminium

**31** Weiß matt · white mat

**42** Anthrazit · anthracite

Incl. 2 x SMD-LED, 8 W  
2 x 800 lm, 3.000 K

**226460231**

**226460242**

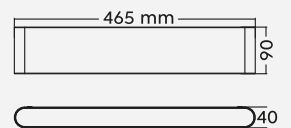

**226460231**



**226460242**



# TAY

Aluminium Druckguss  
diecast aluminium  
fonte d'aluminium  
gegoten aluminium  
aluminio fundido  
pressofusione di alluminio  
fonta aluminiu  
valualumiini  
barwione aluminium

**42** Anthrazit · anthracite

Incl. 2 x SMD-LED, 4,5 W  
2 x 580 lm, 3.000 K

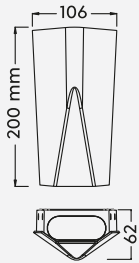

226560242



# COLORADO

Aluminium Druckguss  
diecast aluminium  
fonte d'aluminium  
gegoten aluminium  
aluminio fundido  
pressofusione di alluminio  
fonta aluminiu  
valualumiini  
barwione aluminium

**42** Anthrazit · anthracite

Incl. 2 x SMD-LED, 3 W  
2 x 300 lm, 3.000 K

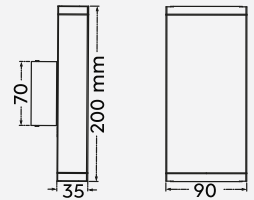

228460242

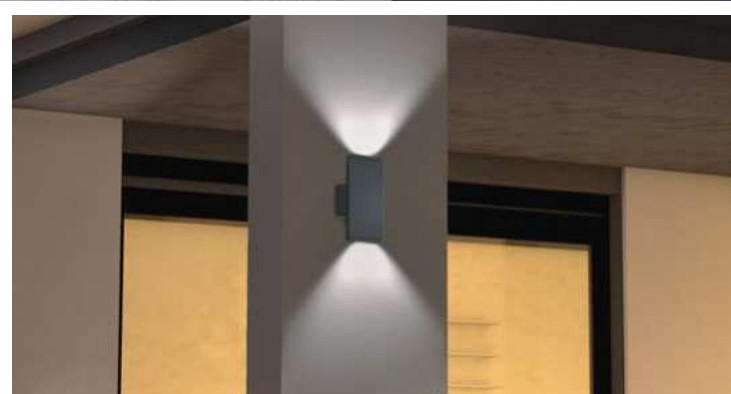
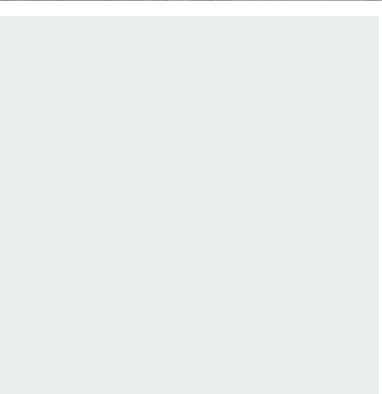

# THAMES

Aluminium Druckguss  
diecast aluminium  
fonte d'aluminium  
gegoten aluminium  
aluminio fundido  
pressofusione di alluminio  
fonta aluminiu  
valualumiini  
barwione aluminium

**42** Anthrazit · anthracite

Incl. 2 x SMD-LED, 3 W  
2 x 340 lm, 3.000 K

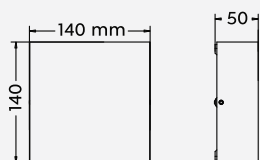

229360242



# ADAJA

Aluminium Druckguss  
diecast aluminium  
fonte d'aluminium  
gegoten aluminium  
aluminio fundido  
pressofusione di alluminio  
fonta aluminiu  
valualumiini  
barwione aluminium

**42** Anthrazit · anthracite

Incl. 2 x SMD-LED, 3 W  
2 x 350 lm, 3.000 K

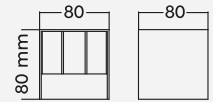

226860242



# ADOUR

Aluminium Druckguss, Acryl  
 diecast aluminium, acryl  
 fonte d'aluminium, acryl  
 gegoten aluminium, acryl  
 aluminio fundido, acrílico  
 pressofusione di alluminio, acrilico  
 fonta aluminiu, acrilic  
 valualumiini, akryyli  
 barwione aluminium, akryl

**31** Weiß matt · white mat

**42** Anthrazit · anthracite

Incl. 1 x SMD-LED, 7,5 W  
 750 lm, 2.300 + 3.000 + 4.000 K

**245560131**

**245560142**



Incl. 1 x SMD-LED, 7,5 W  
 750 lm, 2.300 + 3.000 + 4.000 K

**245569131**

**245569142**



**245560131**



**245560142**



**245569131**



**245569142**

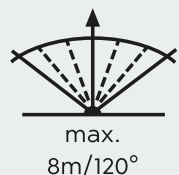
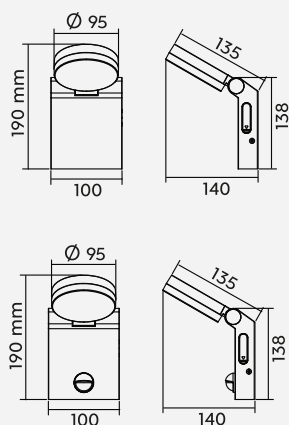



#### DIP SWITCH

Lichtfarben direkt an der Leuchte einstellbar

Colours directly adjustable at the lamp

Les couleurs de la lumière peuvent être réglées directement sur le luminaire

Lichtkleuren direct instelbaar op de lamp

Tonalidades de luz ajustables directamente en la lámpara

Colori della luce regolabili direttamente sulla lampada

Culori ale luminii reglabile direct de la bec

Valon väri asetettävissa suoraan valaisimesta

Barwy światła można ustawić bezpośrednio na oprawie

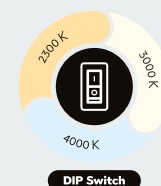

# AVISIO

Aluminium Druckguss, Kunststoff  
diecast aluminium, plastic  
fonte d'aluminium, plastique  
gegoten aluminium, kunststof  
aluminio fundido, plástico  
pressofusione di alluminio, plastica  
fonta aluminiu, plastic  
valualumiini, muovi  
barwione aluminium, plastik

**31** Weiß matt · white mat

**32** Schwarz matt · black mat

Incl. 2 x SMD-LED, 2 W  
2 x 250 lm, 3.000 K

**246760231**

**246760232**

Incl. 4 x SMD-LED, 2 W  
4 x 250 lm, 3.000 K

**646760431**

**646760432**

IP54



246760231



246760232



246760431



246760432

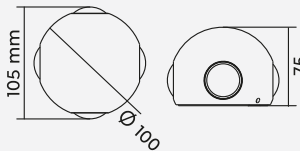
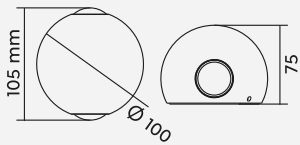





# BELLY

Aluminium Druckguss  
diecast aluminium  
fonte d'aluminium  
gegoten aluminium  
aluminio fundido  
pressofusione di alluminio  
fonta aluminiu  
valualumiini  
barwione aluminium

**42** Anthrazit · anthracite

Incl. 1 x SMD-LED, 8,5 W  
850 lm, 3.000 K

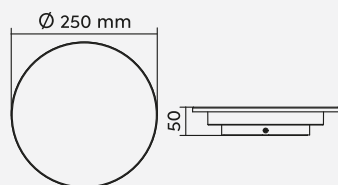

240660142

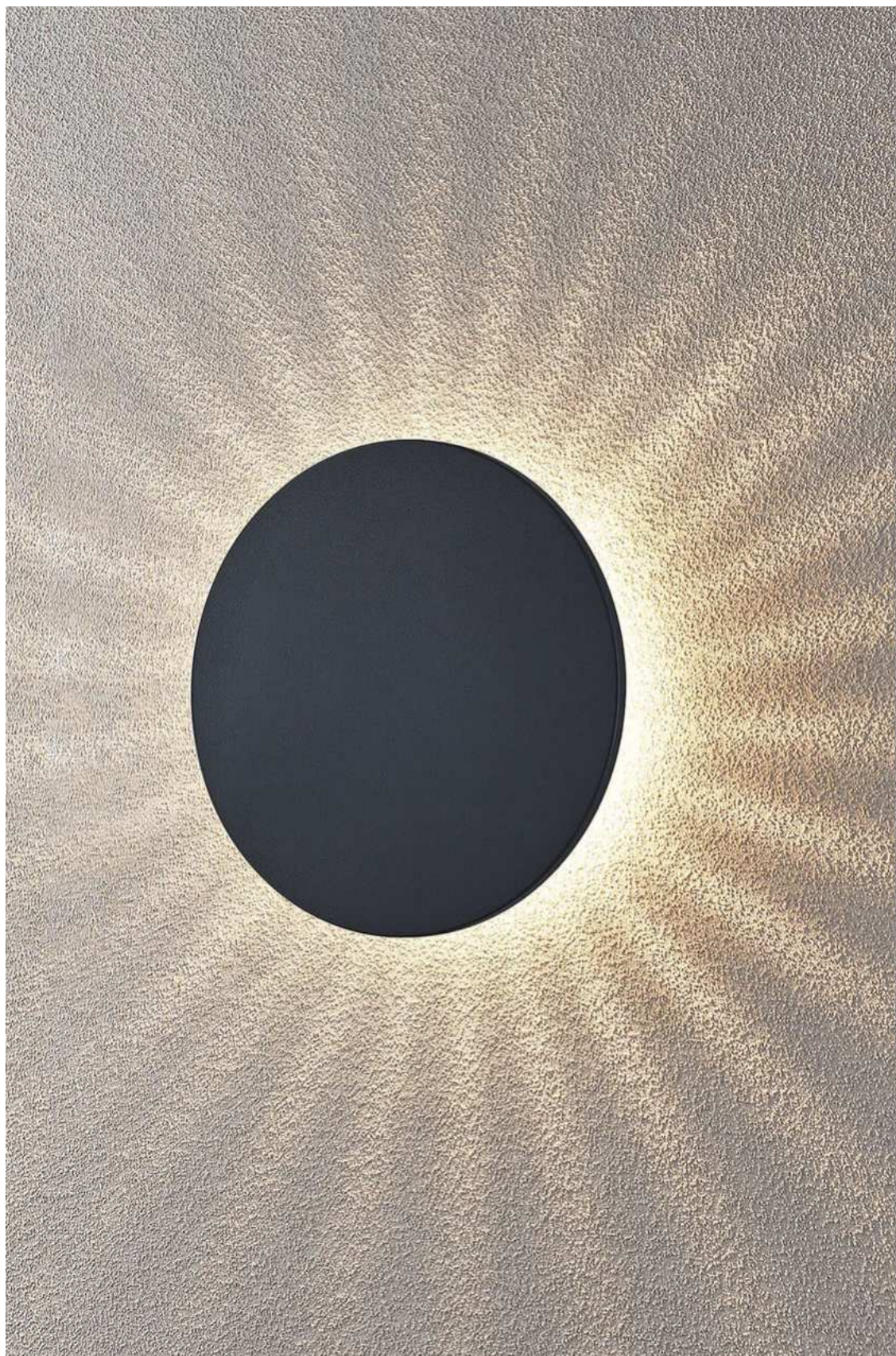

Aluminium Druckguss  
 diecast aluminium  
 fonte d'aluminium  
 gegoten aluminium  
 aluminio fundido  
 pressofusione di alluminio  
 fonta aluminiu  
 valualumiini  
 barwione aluminium

**42** Anthrazit · anthracite

Incl. 1 x SMD-LED, 7,5 W  
 800 lm, 3.000 K

**221460142**

Incl. 2 x SMD-LED, 9 W  
 2 x 900 lm, 3.000 K

**221460242**

IP54

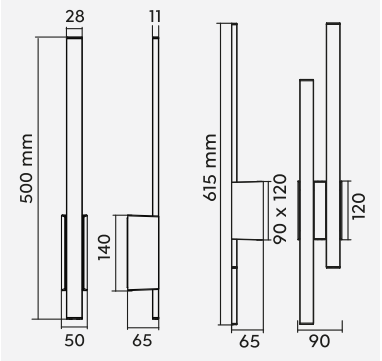

**221460142**

**221460242**



# CLYDE

Aluminium Druckguss  
diecast aluminium  
fonte d'aluminium  
gegoten aluminium  
aluminio fundido  
pressofusione di alluminio  
fonta aluminiu  
valualumiini  
barwione aluminium

**42** Anthrazit · anthracite

Incl. 2 x SMD-LED, 3 W  
2 x 300 lm, 3.000 K

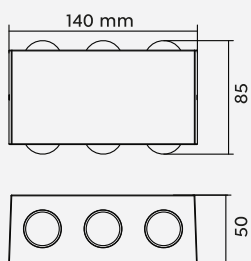



Aluminium Druckguss  
diecast aluminium  
fonte d'aluminium  
gegoten aluminium  
aluminio fundido  
pressofusione di alluminio  
fonta aluminiu  
valualumiini  
barwione aluminium

**42** Anthrazit · anthracite

Incl. 1 x SMD-LED, 7,5 W  
850 lm, 2.300 + 3.000 + 4.000 K

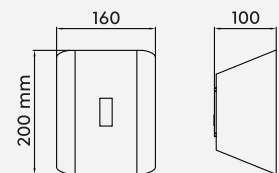

## DIP SWITCH

Lichtfarben direkt an der Leuchte einstellbar

Colours directly adjustable at the lamp

Les couleurs de la lumière peuvent être réglées directement sur le luminaire

Lichtkleuren direct instelbaar op de lamp

Tonalidades de luz ajustables directamente en la lámpara

Colori della luce regolabili direttamente sulla lampada

Culori ale luminii reglabile direct de la bec

Valon väri asetettavissa suoraan valaisimesta

Barwy światła można ustawić bezpośrednio na oprawie

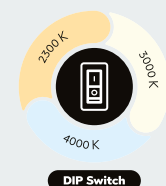

# ARDAS

Aluminium Druckguss, Glas  
diecast aluminium, glass  
fonte d'aluminium, verre  
gegoten aluminium, glas  
aluminio fundido, vidrio  
pressofusione di alluminio, vetro  
fonta aluminiu, sticla  
valualumiini, lasi  
barwione aluminium, szkło

- 24** rostfarbig · rusty
- 31** Weiß matt · white mat
- 32** Schwarz matt · black mat

Excl. 2 x GU10, max. 10 W

212560224

212560231

212560232

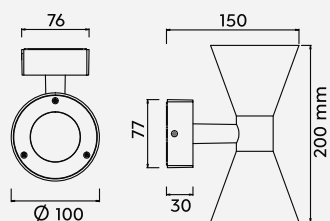

212560232

Empfohlen:  
recommended:

LED GU10, 5 W  
400 lm, 3.000 K  
≥ 110°



955-50



212560224



212560231

# KAVERI



506060142

Aluminium Druckguss  
diecast aluminium  
fonte d'aluminium  
gegooten aluminium  
aluminio fundido  
pressofusione di alluminio  
fonta aluminiu  
valualumiini  
barwione aluminium

**42** Anthrazit · anthracite

Excl. 1 x GU10, max. 5 W



**IP44**

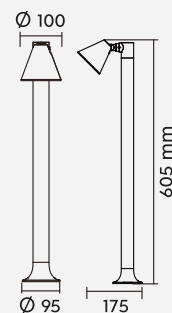
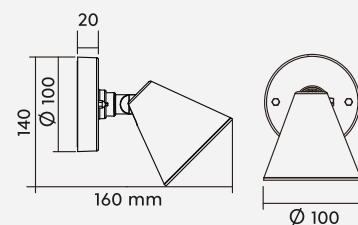

206060142



Empfohlen:  
recommended:

LED GU10, 5 W  
400 lm, 3.000 K  
≥ 110°



**955-50**

# TIBER

Aluminium Druckguss  
diecast aluminium  
fonte d'aluminium  
gegoten aluminium  
aluminio fundido  
pressofusione di alluminio  
fonta aluminu  
valualumiini  
barwione aluminium

**42** Anthrazit · anthracite

Incl. 1 x SMD-LED, 3 W  
300 lm, 3.000 K

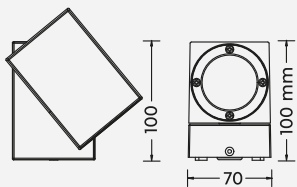

229160142

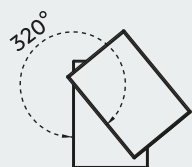



# TUNGA

Aluminium Druckguss  
 diecast aluminium  
 fonte d'aluminium  
 gegoten aluminium  
 aluminio fundido  
 pressofusione di alluminio  
 fonta aluminiu  
 valualumiini  
 barwione aluminium

**42** Anthrazit · anthracite

Incl. 2 x COB-LED, 3,5 W  
 2 x 420 lm, 3.000 K  
**222960242**

**IP54**

Incl. 2 x COB-LED, 3,5 W  
 2 x 420 lm, 3.000 K  
**222969242**

**IP54**

**222969242**

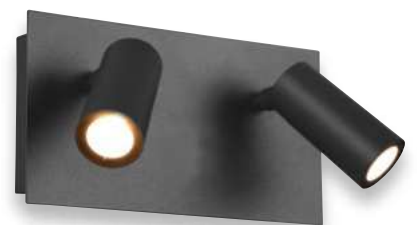
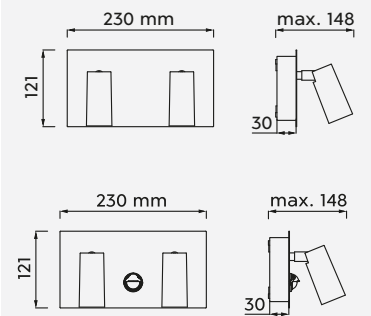

**222960242**

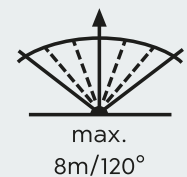

Aluminium Druckguss  
 diecast aluminium  
 fonte d'aluminium  
 gegoten aluminium  
 aluminio fundido  
 pressofusione di alluminio  
 fonta aluminiu  
 valualumiini  
 barwione aluminium

**42 Anthrazit · anthracite**

Excl. 1 x GU10, max. 35 W

**214260142**  
**214269142**  
**414260142**  
**514260142**



Excl. 2 x GU10, max. 35 W

**214260242**  
**214269242**



**214260142**

**214260242**

**214269242**

**214269142**



**514260142**

**414260142**

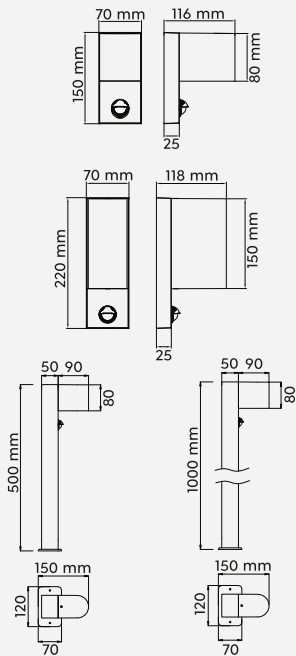

Empfohlen:  
 recommended:

LED GU10, 5 W  
 400 lm, 3.000 K  
 ≥ 110°

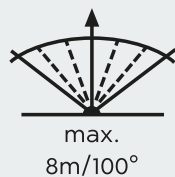

Bewegungssensor  
 Motion sensor  
 Détecteur de mouvement  
 Bewegungssensor  
 Sensor de movimiento  
 Sensore di movimento  
 Senzor de mișcare  
 Liiketunnistin  
 Czujnik ruchu





Aluminium Druckguss  
 diecast aluminium  
 fonte d'aluminium  
 gegoten aluminium  
 aluminio fundido  
 pressofusione di alluminio  
 fonta aluminiu  
 valualumiini  
 barwione aluminium

- 24** rostfarbig · rusty
- 31** Weiß matt · white mat
- 42** Anthrazit · anthracite

Excl. 2 x GU10, max. 35 W

- 204260224**
- 204269224**
- 204260231**
- 204269231**
- 204260242**
- 204269242**



Excl. 1 x GU10, max. 20 W

- 404260142**
- 504260142**

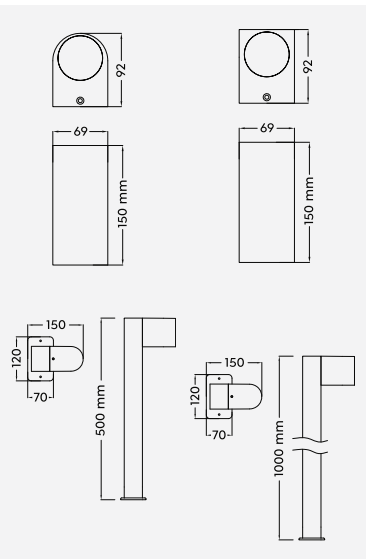

**204260242**



**204269242**



**504260142**



**404260142**

Empfohlen:  
 recommended:

LED GU10, 5 W  
 400 lm, 3.000 K  
 > 110°



**955-50**



**204260224**



**204260231**



204269224



204269231

# ARDILA

Aluminium Druckguss, Glas  
diecast aluminium, glass  
fonte d'aluminium, verre  
gegoten aluminium, glas  
aluminio fundido, vidrio  
pressofusione di alluminio, vetro  
fonta aluminiu, sticla  
valualumiini, lasi  
barwione aluminium, szkło

**35** Holznachbildung · wood imitation

Excl. 1 x E27, max. 20 W

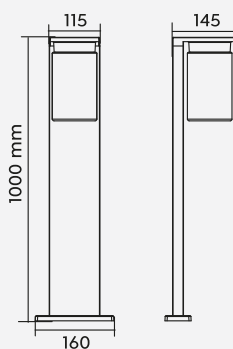
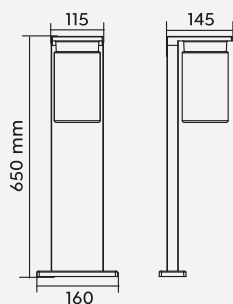
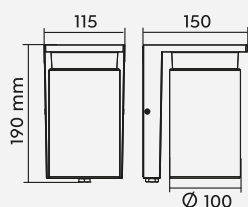

211660135



511660135



411660135

Empfohlen:  
recommended:

Filament LED  
E27, 4 W  
470 lm, 2.700 K



987-400



Dämmerungssensor per Schalter deaktivierbar

On and off switchable dusk sensor

Détecteur de crépuscule commutable

Aan en uit schakelbare schemeringsensor

Sensor de oscuridad conmutable on/off

Sensore crepuscolare commutabile on/off

senzor de lumina/amurg on/off

On/off kytettävä hämärätunnistin

Czujnik zmierzchowy dezaktywowany przez przełącznika

Aç-kapa anahtarlı karanlık sensörü





# ARDILA

Aluminium Druckguss, Glas  
diecast aluminium, glass  
fonte d'aluminium, verre  
gegoten aluminium, glas  
aluminio fundido, vidrio  
pressofusione di alluminio, vetro  
fonta aluminiu, sticla  
valualumiini, lasi  
barwione aluminium, szkło

**32** Schwarz matt · black mat

Excl. 1 x E27, max. 40 W

211660132

411660132

511660132



211660132



511660132



411660132

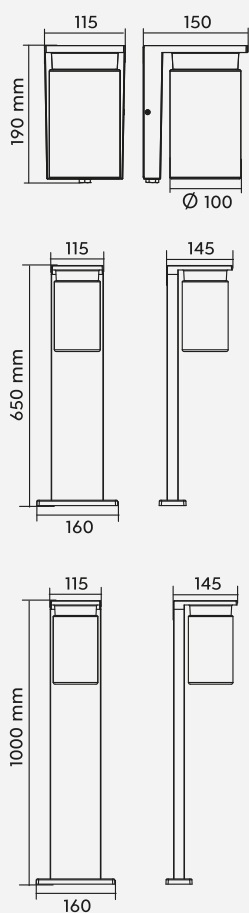

Empfohlen:  
recommended:

Filament LED  
E27, 4 W  
470 lm, 2.700 K



**987-400**



Dämmerungssensor per Schalter deaktivierbar

On and off switchable dusk sensor

Décteur de crépuscule commutable

Aan en uit schakelbare schemeringsensor

Sensor de oscuridad conmutable on/off

Sensore crepuscolare commutabile on/off

senzor de lumina/amurg on/off

On/off kytkettävä hämärätunnistin

Czujnik zmierzchowy dezaktywowany przez przełącznika

Aç-kapa anahtarlı karanlık sensörü







# GARONNE

Aluminium Druckguss, Glas  
 diecast aluminium, glass  
 fonte d'aluminium, verre  
 gegoten aluminium, glas  
 aluminio fundido, vidrio  
 pressofusione di alluminio, vetro  
 fonta aluminii, sticla  
 valualumiini, lasi  
 barwione aluminium, szkło

**42** Anthrazit · anthracite

Excl. 1 x E27, max. 40 W

**201860142**

**401860142**

**501860142**

Excl. 2 x E27, max. 40 W

**201860242**

**601860242**



**601860242**



**201860142**



**201860242**



**401860142**



**501860142**

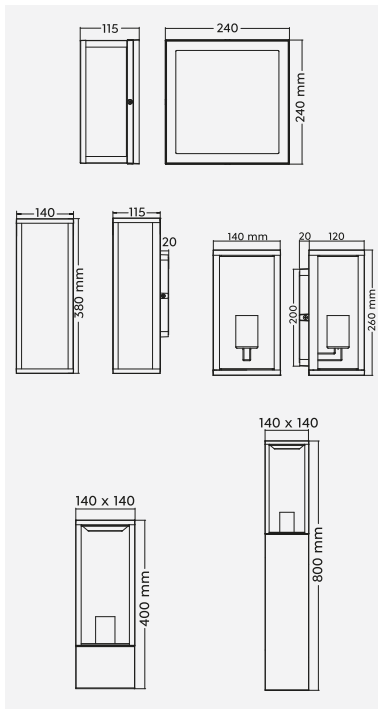

Empfohlen:  
 recommended:

Filament LED  
 E27, 7 W  
 806 lm, 3.000 K



**987-600**

Empfohlen:  
 recommended:

Filament LED  
 E27, 4 W  
 470 lm, 2.700 K



**987-400**



# GARONNE



401869142

Aluminium Druckguss, Glas  
diecast aluminium, glass  
fonte d'aluminium, verre  
gegoten aluminium, glas  
aluminio fundido, vidrio  
pressofusione di alluminio, vetro  
fonta aluminiu, sticla  
valualumiini, lasi  
barwione aluminium, szkło

**42** Anthrazit · anthracite

Excl. 1 x E27, max. 40 W



**IP44**

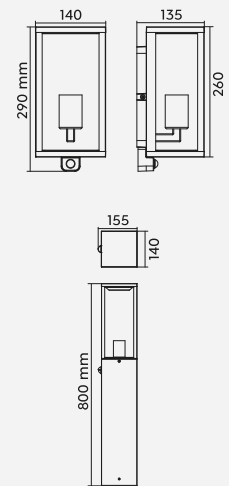

201869142

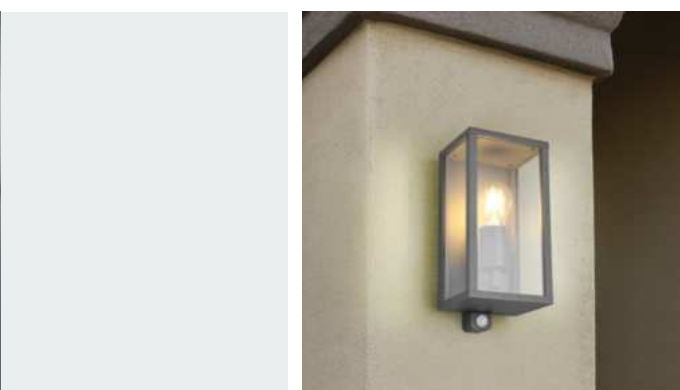

Bewegungssensor  
Motion sensor  
Décteur de mouvement  
Bewegingssensor  
Sensor de movimiento  
Sensore di movimento  
Senzor de mişcare  
Liiketunnistin  
Czujnik ruchu

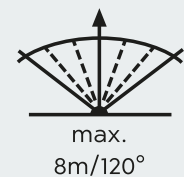

# COOPER

Edelstahl, Kunststoff  
steel, plastic  
acier, plastique  
staal, kunststof  
acero, plástico  
acciaio, plastica  
inox, plastic  
teräs, muovi  
stal, plastik

**42** Anthrazit · anthracite

Excl. 1 x E27, max. 40 W



**IP44**

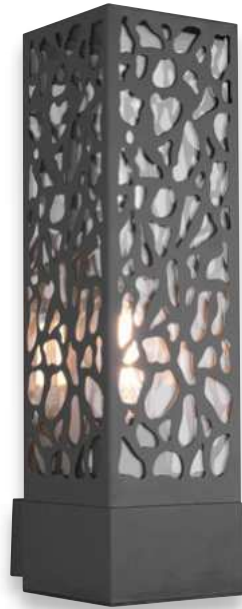

207360142



407360142



507360142

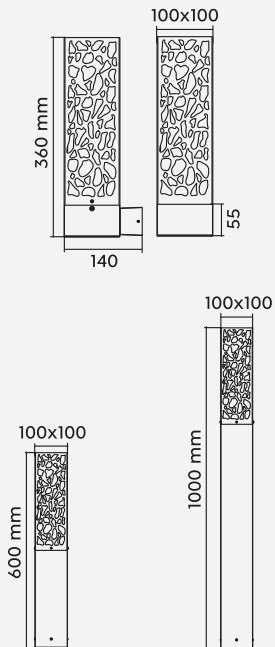

Empfohlen:  
recommended:

Filament LED  
E27, 4 W  
470 lm, 2.700 K



**987-400**





# HOOSIC

Aluminium Druckguss, Kunststoff  
 diecast aluminium, plastic  
 fonte d'aluminium, plastique  
 gegoten aluminium, kunststof  
 aluminio fundido, plástico  
 pressofusione di alluminio, plastica  
 fonta aluminiu, plastic  
 valualumiini, muovi  
 barwione aluminium, plastik

**32** Schwarz matt · black mat

Excl. 1 x E27, max. 28 W

**222260132**

**422260132**

**522260132**

Excl. 2 x E27, max. 28 W

**222260232**



**222260132**



**222260232**



**522260132**



**422260132**

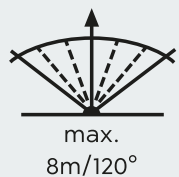
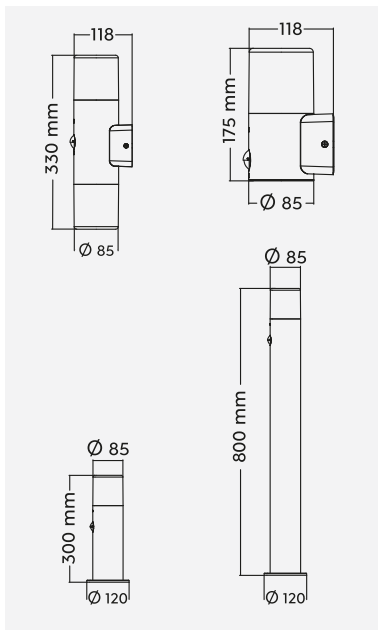

Bewegungssensor  
 Motion sensor  
 Détecteur de mouvement  
 Bewegungssensor  
 Sensor de movimiento  
 Sensore di movimento  
 Senzor de mişcare  
 Liiketunnistin  
 Czujnik ruchu





# HOOSIC

Aluminium Druckguss, Kunststoff  
 diecast aluminium, plastic  
 fonte d'aluminium, plastique  
 gegoten aluminium, kunststof  
 aluminio fundido, plástico  
 pressofusione di alluminio, plastica  
 fonta aluminiu, plastic  
 valualumiini, muovi  
 barwione aluminium, plastik

**32** Schwarz matt · black mat

Excl. 1 x E27, max. 28 W

**224060132**

**424060132**

**524060132**

Excl. 2 x E27, max. 28 W

**224060232**



**224060232**



**224060132**



**424060132**



**524060132**

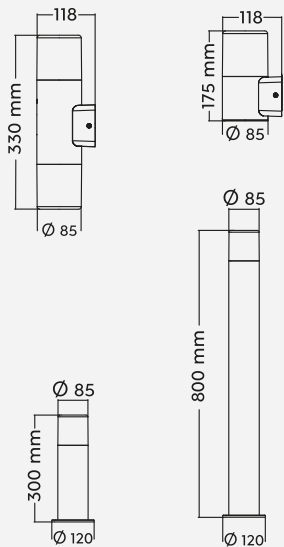

Empfohlen:  
 recommended:

LED E27, 4 W  
 470 lm, 2.700 K



**987-400**







# HOOSIC

Aluminium Druckguss, Kunststoff  
 diecast aluminium, plastic  
 fonte d'aluminium, plastique  
 gegoten aluminium, kunststof  
 aluminio fundido, plástico  
 pressofusione di alluminio, plastica  
 fonta aluminiu, plastic  
 valualumiini, muovi  
 barwione aluminium, plastik

**42** Anthrazit · anthracite

Excl. 1 x E27, max. 28 W

**222260142**

**422260142**

**522260142**

Excl. 2 x E27, max. 28 W

**222260242**



**222260142**



**222260242**



**422260142**



**522260142**

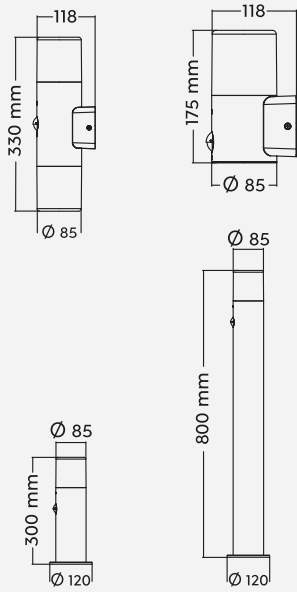

Empfohlen:  
 recommended:

LED E27, 4,9 W  
 470 lm, 3.000 K



**987-60**



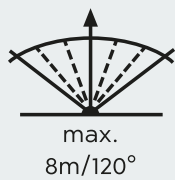

Bewegungssensor  
Motion sensor  
Détecteur de mouvement  
Bewegungssensor  
Sensor de movimiento  
Sensore di movimento  
Senzor de mişcare  
Liiketunnistin  
Czujnik ruchu



# HOOSIC

Aluminium Druckguss, Kunststoff  
 diecast aluminium, plastic  
 fonte d'aluminium, plastique  
 gegoten aluminium, kunststof  
 aluminio fundido, plástico  
 pressofusione di alluminio, plastica  
 fonta aluminiu, plastic  
 valualumiini, muovi  
 barwione aluminium, plastik

**42** Anthrazit · anthracite

Excl. 1 x E27, max. 28 W

**224060142**

**424060142**

**524060142**

Excl. 2 x E27, max. 28 W

**224060242**



IP44



**224060142**



**224060242**



**424060142**



**524060142**

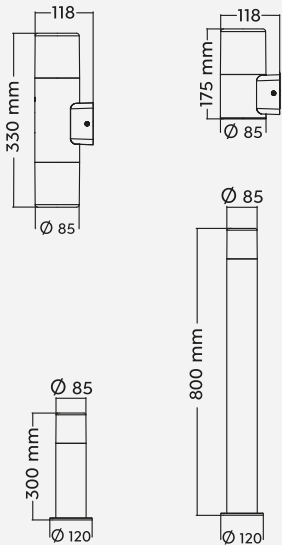

Empfohlen:  
 recommended:

LED E27, 4,9 W  
 470 lm, 3.000 K



**987-60**



# HOOSIC

Aluminium Druckguss, Kunststoff  
diecast aluminium, plastic  
fonte d'aluminium, plastique  
gegoten aluminium, kunststof  
aluminio fundido, plástico  
pressofusione di alluminio, plastica  
fonta aluminiu, plastic  
valualumiini, muovi  
barwione aluminium, plastik

**42** Anthrazit · anthracite

Excl. 1 x E27, max. 28 W



**IP44**



424067142



# HOOSIC

Aluminium Druckguss, Kunststoff  
 diecast aluminium, plastic  
 fonte d'aluminium, plastique  
 gegoten aluminium, kunststof  
 aluminio fundido, plástico  
 pressofusione di alluminio, plastica  
 fonta aluminiu, plastic  
 valualumiini, muovi  
 barwione aluminium, plastik

**24** rostfarbig · rusty

Excl. 1 x E27, max. 28 W

**222260124**

**422260124**

**522260124**

Excl. 2 x E27, max. 28 W

**222260224**



**IP44**



**222260124**



**222260224**



**422260124**



**522260124**

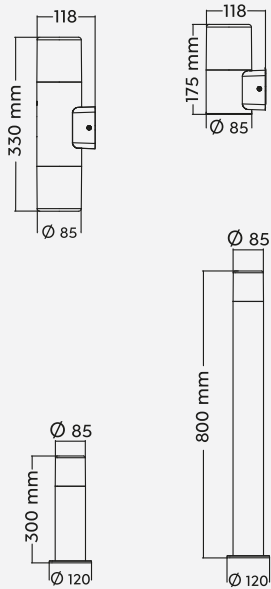

Empfohlen:  
 recommended:

LED E27, 4,9 W  
 470 lm, 3.000 K



**987-60**

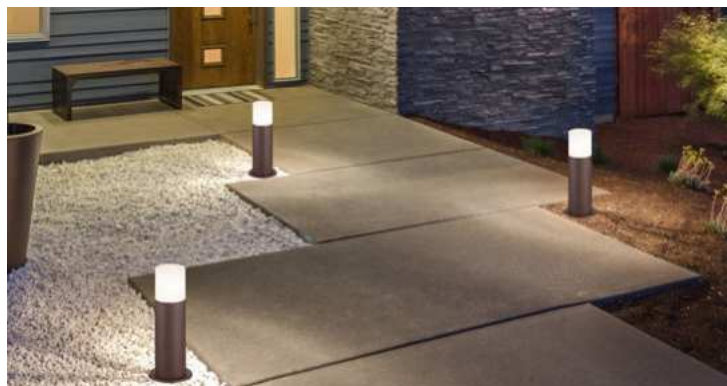



# HUDSON

Aluminium Druckguss, Kunststoff  
 diecast aluminium, plastic  
 fonte d'aluminium, plastique  
 gegoten aluminium, kunststof  
 aluminio fundido, plástico  
 pressofusione di alluminio, plastica  
 fonta aluminiu, plastic  
 valualumiini, muov  
 barwione aluminium, plastik

**42** Anthrazit · anthracite

Incl. 1 x LED E14, 4 W  
 320 lm, 3.000 K

**220060142**

**420060142**

**520060142**

Incl. 2 x LED E14, 4 W  
 2 x 320 lm, 3.000 K

**220060242**

IP44



**220060142**



**220060242**



**520060142**



**420060142**

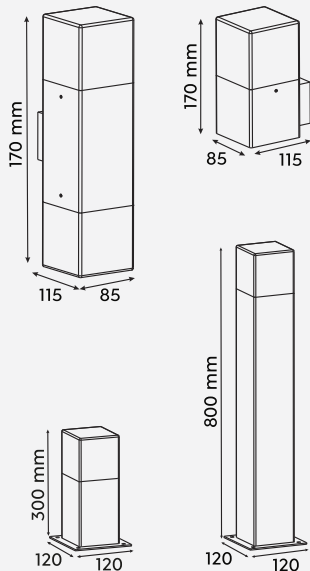

Incl. LED E14, 3,5 W  
 320 lm, 3.000 K



**983-40**

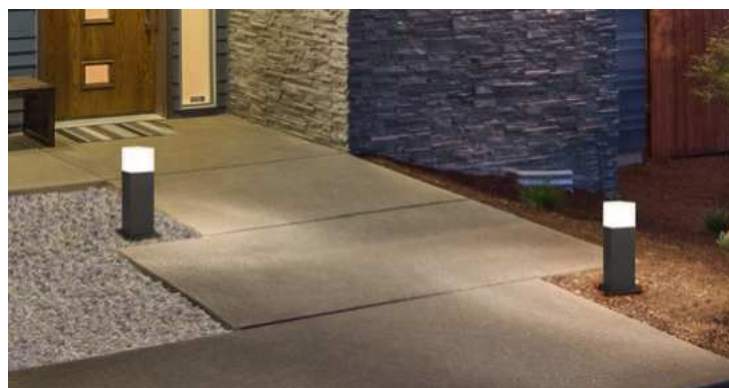





# CUBANGO

Aluminium Druckguss, Kunststoff  
diecast aluminium, plastic  
fonte d'aluminium, plastique  
gegoten aluminium, kunststof  
aluminio fundido, plástico  
pressofusione di alluminio, plastica  
fonta aluminiu, plastic  
valualumiini, muov  
barwione aluminium, plastik

**42** Anthrazit · anthracite

Incl. 1 x LED E27, 4,9 W  
470 lm, 3.000 K

**221560142**

Incl. 2 x LED E27, 4,9 W  
470 lm, 3.000 K

**421560242**

IP54

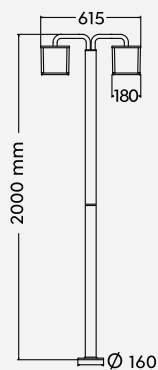
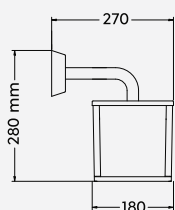

221560142



421560242

Incl. LED E27, 4,9 W  
470 lm, 3.000 K





# CAVADO

Aluminium Druckguss, Kunststoff  
 diecast aluminium, plastic  
 fonte d'aluminium, plastique  
 gegoten aluminium, kunststof  
 aluminio fundido, plástico  
 pressofusione di alluminio, plastica  
 fonta aluminiu, plastic  
 valualumiini, muovi  
 barwione aluminium, plastik

**42 Anthrazit · anthracite**

Excl. 1 x E27, max. 40 W

**211069142**



Excl. 1 x E27, max. 40 W

**211060142**

**411060142**

Excl. 3 x E27, max. 40 W

**411060342**

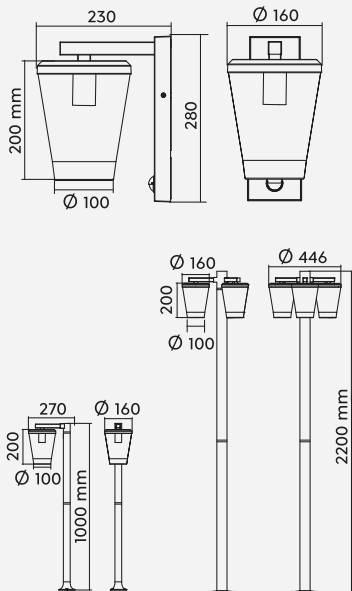

**211069142**



**211060142**

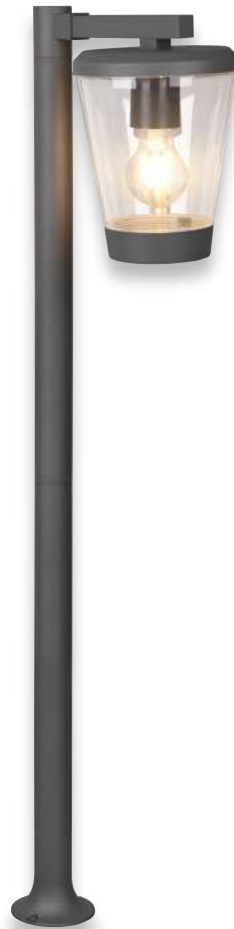

**411060142**



**411060342**

Empfohlen:  
 recommended:

Filament LED  
 E27, 4 W  
 470 lm, 2.700 K



**987-400**

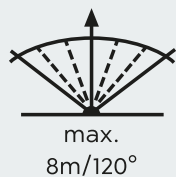



# SAMBESI

Aluminium Druckguss, Acryl  
diecast aluminium, acryl  
fonte d'aluminium, acryl  
gegoten aluminium, acryl  
aluminio fundido, acrílico  
pressofusione di alluminio, acrilico  
fonta aluminiu, acrilic  
valualumiini, akryyli  
barwione aluminium, akryl

**31** Weiß matt · white mat

**42** Anthrazit · anthracite

Excl. 1 x E27, max. 28 W

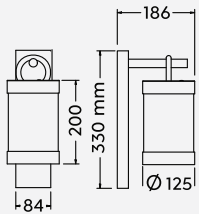

204160131

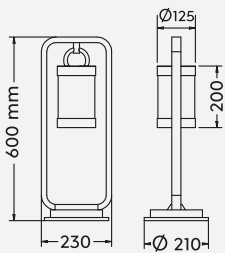

504160142

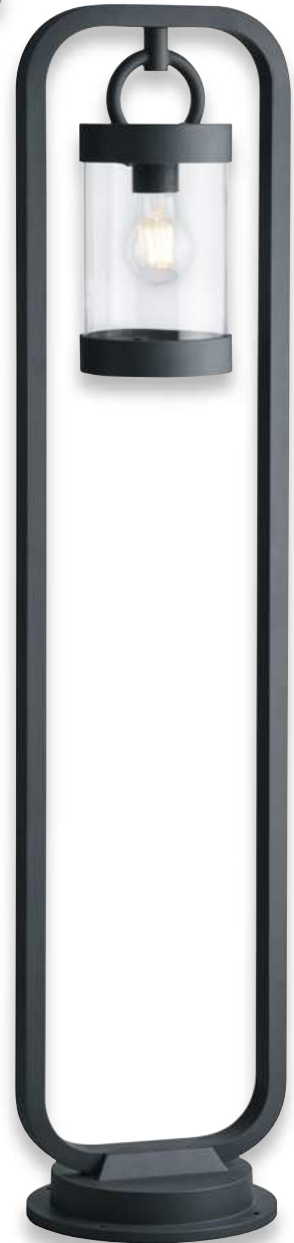
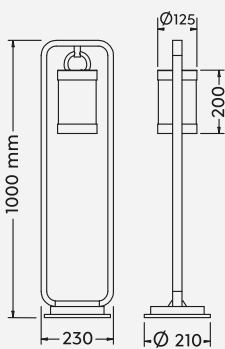

404160142

Empfohlen:  
recommended:

Filament LED  
E27, 4 W  
470 lm, 2.700 K



987-400



Dämmerungssensor per Schalter deaktivierbar

On and off switchable dusk sensor

Détecteur de crépuscule commutable

Aan en uit schakelbare schemeringsensor

Sensor de oscuridad conmutable on/off

Sensore crepuscolare commutabile on/off

senzor de lumina/amurg on/off

On/off kytkettävä hämärätunnistin

Czujnik zmierzchowy dezaktywowany przez przełącznika

Aç-kapa anahtarlı karanlık sensörü



# SAMBESI

Aluminium Druckguss, Acryl  
diecast aluminium, acryl  
fonte d'aluminium, acryl  
gegoten aluminium, acryl  
aluminio fundido, acrílico  
pressofusione di alluminio, acrilico  
fonta aluminiu, acrilic  
valualumiini, akryyli  
barwione aluminium, akryl

24 rostfarbig · rusty

Excl. 1 x E27, max. 28 W



204160124

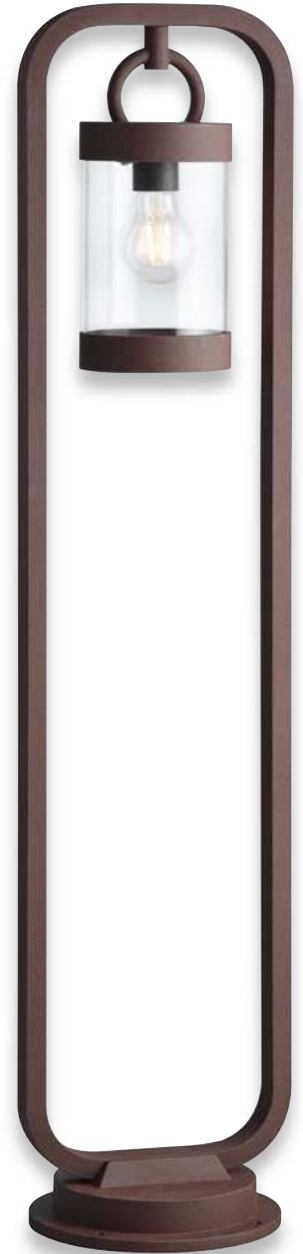

404160124

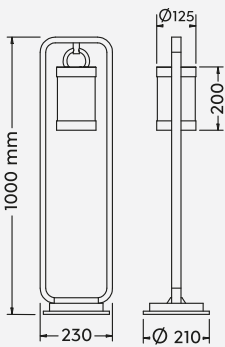
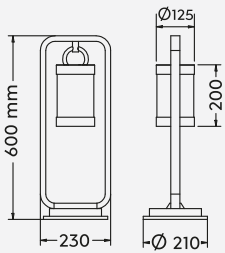
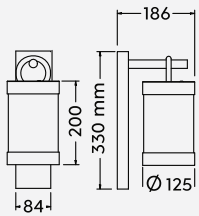

504160124

Empfohlen:  
recommended:

Filament LED  
E27, 4 W  
470 lm, 2.700 K



987-400



Dämmerungssensor per Schalter deaktivierbar

On and off switchable dusk sensor

Détecteur de crépuscule commutable

Aan en uit schakelbare schemeringsensor

Sensor de oscuridad conmutable on/off

Sensore crepuscolare commutabile on/off

senzor de lumina/amurg on/off

On/off kytkettävä hämärätunnistin

Czujnik zmierzchowy dezaktywowany przez przełącznika

Aç-kapa anahtarlı karanlık sensörü



# SAMBESI

Aluminium Druckguss, Kunststoff  
 diecast aluminium, plastic  
 fonte d'aluminium, plastique  
 gegoten aluminium, kunststof  
 aluminio fundido, plástico  
 pressofusione di alluminio, plastica  
 fonta aluminiu, plastic  
 valualumiini, muovi  
 barwione aluminium, plastik

- 24** rostfarbig · rusty
- 31** Weiß matt · white mat
- 42** Anthrazit · anthracite

Excl. 1 x E27, max. 28 W

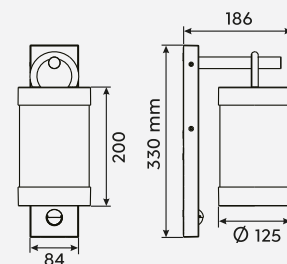

204169142



204169131



Bewegungssensor  
 Motion sensor  
 Détecteur de mouvement  
 Bewegungssensor  
 Sensor de movimiento  
 Sensore di movimento  
 Senzor de mişcare  
 Liiketunnistin  
 Czujnik ruchu

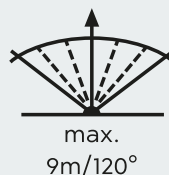

204169124

# LUNGA

Aluminium Druckguss, Glas  
diecast aluminium, glass  
fonte d'aluminium, verre  
gegoten aluminium, glas  
aluminio fundido, vidrio  
pressofusione di alluminio, vetro  
fonta aluminiu, sticla  
valualumiini, lasi  
barwione aluminium, szkło

**42 Anthrazit · anthracite**

Excl. 1 x E27, max. 40 W

**212060142**



Excl. 1 x E27, max. 40 W

**212069142**



212060142



212069142

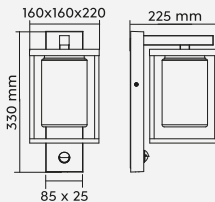
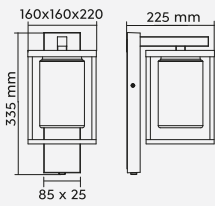

Empfohlen:  
recommended:

Filament LED  
E27, 4 W  
470 lm, 2.700 K



**987-400**



Dämmerungssensor per Schalter deaktivierbar

On and off switchable dusk sensor

Détecteur de crépuscule commutable

Aan en uit schakelbare schemeringsensor

Sensor de oscuridad conmutable on/off

Sensore crepuscolare commutabile on/off

senzor de lumina/amurg on/off

On/off kytkettävä hämärätunnistin

Czujnik zmierzchowy dezaktywowany przez przełącznika

Aç-kapa anahtarlı karanlık sensörü





Bewegungssensor  
Motion sensor  
Détecteur de mouvement  
Bewegungssensor  
Sensor de movimiento  
Sensore di movimento  
Senzor de mişcare  
Liiketunnistin  
Czujnik ruchu

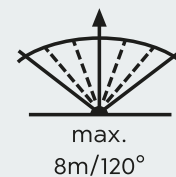

# NORMAN

Aluminium Druckguss, Acryl  
diecast aluminium, acryl  
fonte d'aluminium, acryl  
gegoten aluminium, acryl  
aluminio fundido, acrílico  
pressofusione di alluminio, acrilico  
fonta aluminiu, acrilic  
valualumiini, akryyli  
barwione aluminium, akryl

24 rostfarbig · rusty

42 Anthrazit · anthracite

Excl. 1 x E27, max. 40 W

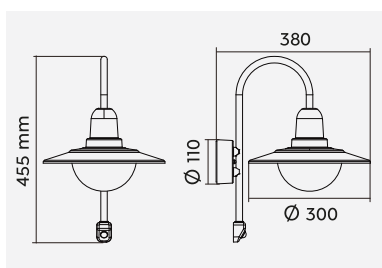

207269142



207269124

Empfohlen:  
recommended:

LED E27, 4,9 W  
470 lm, 3.000 K

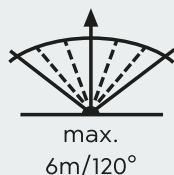

Bewegungssensor  
Motion sensor  
Détecteur de mouvement  
Bewegungssensor  
Sensor de movimiento  
Sensore di movimento  
Senzor de mișcare  
Liiketunnistin  
Czujnik ruchu

# BRENTA

Aluminium Druckguss, Glas  
diecast aluminium, glass  
fonte d'aluminium, verre  
gegoten aluminium, glas  
aluminio fundido, vidrio  
pressofusione di alluminio, vetro  
fonta aluminiu, sticla  
valualumiini, lasi  
barwione aluminium, szkło

**24** rostfarbig · rusty

**42** Anthrazit · anthracite

Excl. 1 x E27, max. 40 W



**IP44**

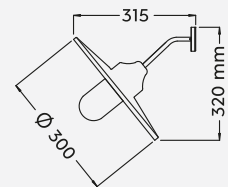

201760124



201760142



Empfohlen:  
recommended:

Filament LED  
E27, 4 W  
470 lm, 2.700 K



987-400

# OLONA

Aluminium Druckguss, Glas  
diecast aluminium, glass  
fonte d'aluminium, verre  
gegoten aluminium, glas  
aluminio fundido, vidrio  
pressofusione di alluminio, vetro  
fonta aluminiu, sticla  
valualumiini, lasi  
barwione aluminium, szkło

**24** rostfarbig · rusty

**42** Anthrazit · anthracite

Excl. 1 x E27, max. 40 W



IP23

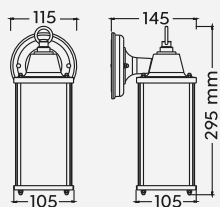

201960142



201960124

Empfohlen:  
recommended:

Filament LED  
E27, 4 W  
470 lm, 2.700 K



987-400



# TANARO

Aluminium Druckguss, Acryl  
diecast aluminium, Acryl  
fonte d'aluminium, acryl  
gegooten aluminium, acryl  
aluminio fundido, acrílico  
pressofusione di alluminio, acrilico  
fonta aluminiu, acrilic  
valualumiini, akryyli  
barwione aluminium, akryl

**24** rostfarbig · rusty

**42** Anthrazit · anthracite

Excl. 1 x E27, max. 40 W



**IP44**

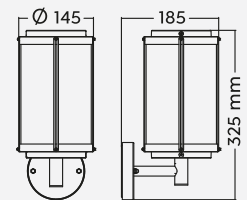

202360142



202360124



Empfohlen:  
recommended:

Filament LED  
E27, 4 W  
470 lm, 2.700 K



987-400

# DUERO

Aluminium Druckguss, Glas  
diecast aluminium, glass  
fonte d'aluminium, verre  
gegoten aluminium, glas  
aluminio fundido, vidrio  
pressofusione di alluminio, vetro  
fonta aluminiu, sticla  
valualumiini, lasi  
barwione aluminium, szkło

**24** rostfarbig · rusty

**42** Anthrazit · anthracite

Excl. 1 x E27, max. 40 W



IP44

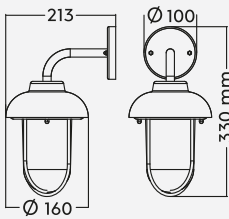

202760124



202760142

Empfohlen:  
recommended:

Filament LED  
E27, 4 W  
470 lm, 2.700 K



987-400





# TUELA

Aluminium Druckguss, Glas  
diecast aluminium, glass  
fonte d'aluminium, verre  
gegoten aluminium, glas  
aluminio fundido, vidrio  
pressofusione di alluminio, vetro  
fonta aluminiu, sticla  
valualumiini, lasi  
barwione aluminium, szkło

**42** Anthrazit · anthracite

Excl. 1 x E27, max. 40 W

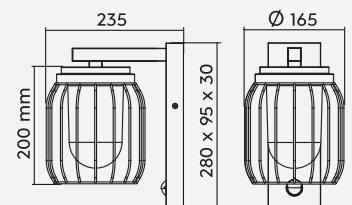

210869142



210860142



Bewegungssensor  
Motion sensor  
Détecteur de mouvement  
Bewegungssensor  
Sensor de movimiento  
Sensore di movimento  
Senzor de mişcare  
Liiketunnistin  
Czujnik ruchu

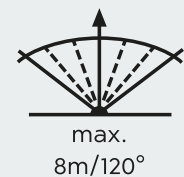
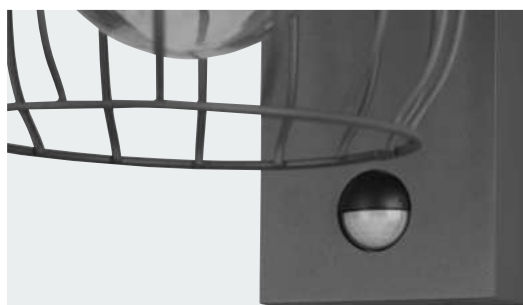

max.  
8m/120°

# VOLTURNO

Aluminium Druckguss, Glas  
diecast aluminium, glass  
fonte d'aluminium, verre  
gegoten aluminium, glas  
aluminio fundido, vidrio  
pressofusione di alluminio, vetro  
fonta aluminiu, sticla  
valualumiini, lasi  
barwione aluminium, szkło

**28** rostfarbig antik · antique rust

Excl. 1 x E27, max. 40 W

205960128

205967128

405960128

505960128

Excl. 3 x E27, max. 60 W

405960328



IP44



205967128



205960128

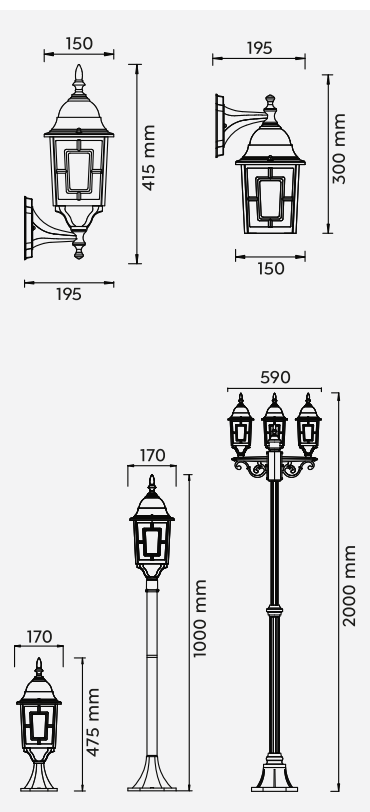

405960128



505960128



405960328

Empfohlen:  
recommended:

Filament LED  
E27, 4 W  
470 lm, 2.700 K



987-400





# LIVENZA

Aluminium Druckguss, Glas  
diecast aluminium, glass  
fonte d'aluminium, verre  
gegoten aluminium, glas  
aluminio fundido, vidrio  
pressofusione di alluminio, vetro  
fonta aluminiu, sticla  
valualumiini, lasi  
barwione aluminium, szkło

**32** Schwarz matt · black mat

Excl. 1 x E27, max. 40 W

**205760132**

**205767132**

**405760132**

**505760132**

Excl. 3 x E27, max. 40 W

**405760332**



**IP44**

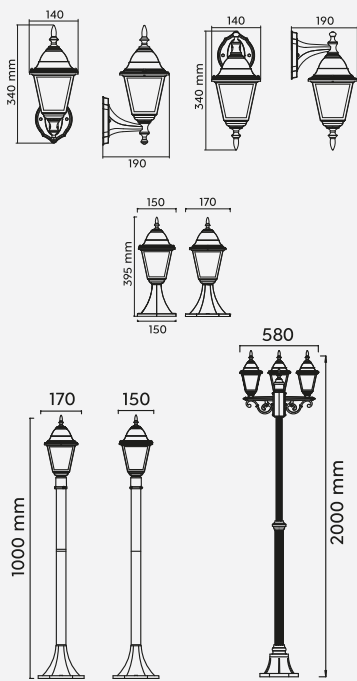

**205767132**



**205760132**



**405760132**



**505760132**



**405760332**

Empfohlen:  
recommended:

Filament LED  
E27, 4 W  
470 lm, 2.700 K



**987-400**





# ELVO

Aluminium Druckguss, Glas  
 diecast aluminium, glass  
 fonte d'aluminium, verre  
 gegoten aluminium, glas  
 aluminio fundido, vidrio  
 pressofusione di alluminio, vetro  
 fonta aluminiu, sticla  
 valualumiini, lasi  
 barwione aluminium, szkło

**32** Schwarz matt · black mat

Excl. 1 x E27, max. 40 W

**206960132**  
**206967132**  
**406960132**  
**506960132**

Excl. 3 x E27, max. 40 W

**406960332**

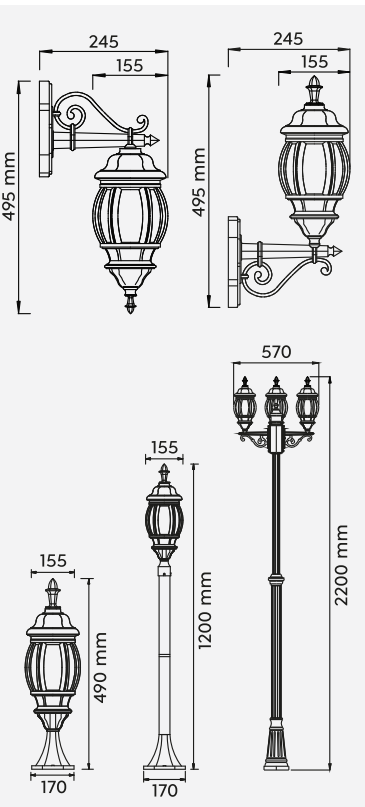

**206960132**



**206967132**



**406960332**



**406960132**



**506960132**

Empfohlen:  
 recommended:

Filament LED  
 E27, 4 W  
 470 lm, 2.700 K



**987-400**





# UBANGI

Aluminium Druckguss  
diecast aluminium  
fonte d'aluminium  
gegoten aluminium  
aluminio fundido  
pressofusione di alluminio  
fonta aluminii  
valualumiini  
barwione aluminium

**42** Anthrazit · anthracite

Excl. 1 x GU10, max. 28 W

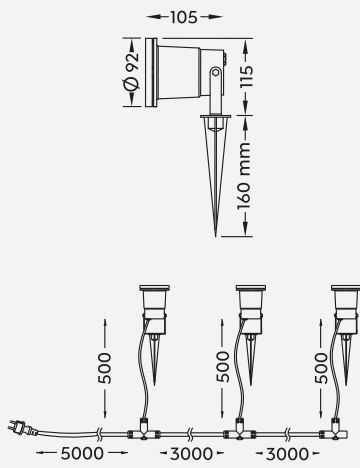

Empfohlen:  
recommended:

LED GU10, 5 W  
400 lm, 3.000 K  
≥ 110°



955-50





# MAREB

Aluminium Druckguss  
diecast aluminium  
fonte d'aluminium  
gegoten aluminium  
aluminio fundido  
pressofusione di alluminio  
fonta aluminiu  
valualumiini  
barwione aluminium

**42** Anthrazit · anthracite

Incl. 1 x SMD-LED, 11 W  
1.000 lm, 3.000 K

IP65

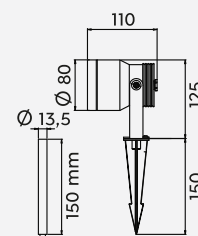

821860142



# BELAJA

Bodeneinbaustrahler  
Recessed floor lamps  
Luminaires encastrés de sol  
grond inbouwspot  
Lámparas de pie empotradas  
Incasso Calpestabili  
Lampi incastrate in podea  
upotetut maavalot  
wpuszczane lampy podłogowe

**07** Nickel matt · nickel mat

Incl. SMD-LED, 3,5 W  
350 lm, 3.000 K

**821660107**

Incl. SMD-LED, 8 W  
900 lm, 3.000 K

**821660207**

IP65

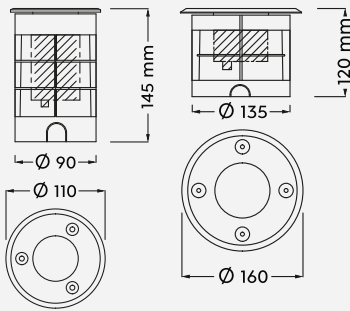

**821660107**



**821660207**



Abstrahlwinkel  
Emission angle  
Angle de rayonnement  
Uitstraalhoek  
Ángulo de emisión  
Angolo di emissione  
Unghiul de emisii  
Säteilykulma  
Kąt emisji



Belastbarkeit  
Resilience  
Limite de charge  
Belastbaarheid  
Resistencia  
Resistenza  
Rezistența la solicitare  
Kuormitettavuus  
Nośność



# GARTENSTECKDOSEN · GARDEN SOCKETS



9964-42

Aluminium Druckguss  
 diecast aluminium  
 fonte d'aluminium  
 gegoten aluminium  
 aluminio fundido  
 pressofusione di alluminio  
 fonta aluminiu  
 valualumiini  
 barwione aluminium

**42** Anthrazit · anthracite

max. 3.600 W

IP44  x 4

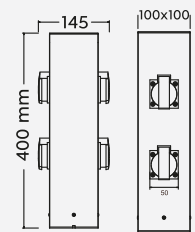

9962-11

Polyresin  
 polyresin  
 polyresin  
 polyresin  
 poliresina  
 poliestere  
 polirasina  
 polyresiini  
 polyresin

**11** Grau · grey

max. 3.600 W

**9962-11**

IP44    x 4

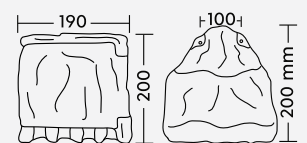

 x 4



# UNIVERSAL-ERDSPIESS · GROUND SPIKE

Erdspieß, Edelstahl  
Ground spike, steel  
Piquet de terre, acier  
Aardingspin, staal  
Espiga, acero  
Picchetto, acciaio  
Țepușă pentru pământ, inox  
Maapiikki, teräs  
Žerdz, stal

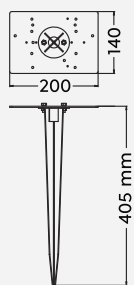

9960-07

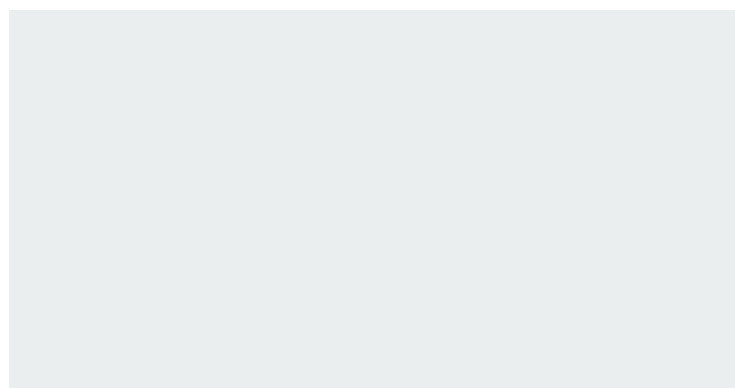

# ECKBEFESTIGUNG · CORNER FASTENING

Eckbefestigung, Kunststoff  
Corner fastening, plastic  
Montage en angle, plastique  
Hoekbevestiging, kunststof  
Cantонера, plástico  
Montaggio ad angolo, plastica  
Fixare pentru colț, plastic  
Kulmakiinnike, muovi  
Okucie narożne, plastik

**32** Schwarz matt · black mat



**9965-32**

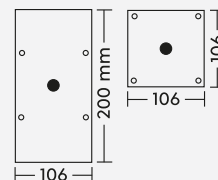





# PALOMA

Metall, Kunststoff  
 metal, plastic  
 metale, plastique  
 metaal, kunststof  
 metal, plástico  
 metallo, plastica  
 metal, plastic  
 metalli, muovi  
 metal, plastik

**42** Anthrazit · anthracite

Excl. 1 x E27, max. 28 W



R21719142



R41719142



R51719142

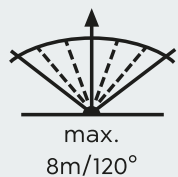
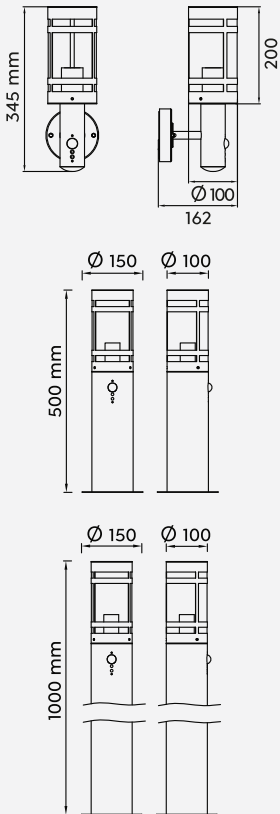

Bewegungssensor  
 Motion sensor  
 Détecteur de mouvement  
 Bewegungssensor  
 Sensor de movimiento  
 Sensore di movimento  
 Senzor de mişcare  
 Liiketunnistin  
 Czujnik ruchu







# PALOMA

Metall, Kunststoff  
metal, plastic  
metale, plastique  
metaal, kunststof  
metal, plástico  
metallo, plastica  
metal, plastic  
metalli, muovi  
metal, plastik

42 Anthrazit · anthracite

Excl. 1 x E27, max. 28 W



IP44

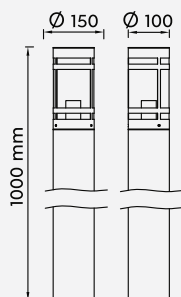
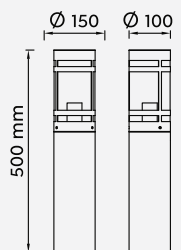
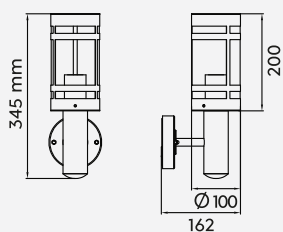

R21716142



R51716142



R41716142

Empfohlen:  
recommended:

Filament LED  
E27, 4 W  
470 lm, 2.700 K





# BONITO

Aluminium Druckguss, Kunststoff  
 diecast aluminium, plastic  
 fonte d'aluminium, plastique  
 gegoten aluminium, kunststof  
 aluminio fundido, plástico  
 pressofusione di alluminio, plastica  
 fonta aluminiu, plastic  
 valualumiini, muovii  
 barwione aluminium, plastik

- 24** rostfarbig · rusty
- 31** Weiß matt · white mat
- 32** Schwarz matt · black mat

Excl. 1 x E27, max. 28 W

- R21596124**
- R21596131**
- R21596132**



Excl. 1 x E27, max. 28 W

- R21599124**
- R21599131**
- R21599132**



R21596124



R21596131



R21596132



R21599131



R21599132



R21599124

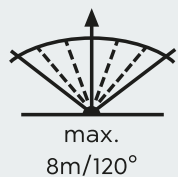
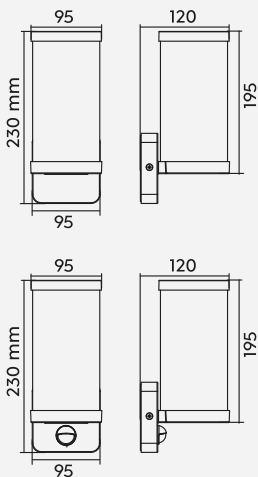

Bewegungssensor  
 Motion sensor  
 Détecteur de mouvement  
 Bewegungssensor  
 Sensor de movimiento  
 Sensore di movimento  
 Senzor de mişcare  
 Liiketunnistin  
 Czujnik ruchu





# CORDOBA

Kunststoff  
plastic  
plastique  
kunststof  
plástico  
plastica  
plastic  
muovi  
plastik

**31** Weiß matt · white mat

**32** Schwarz matt · black mat

Incl. 2 x SMD-LED, 2 W  
2 x 200 lm, 3.000 K



R28222631



R28222632

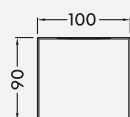
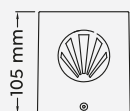

# ROSARIO

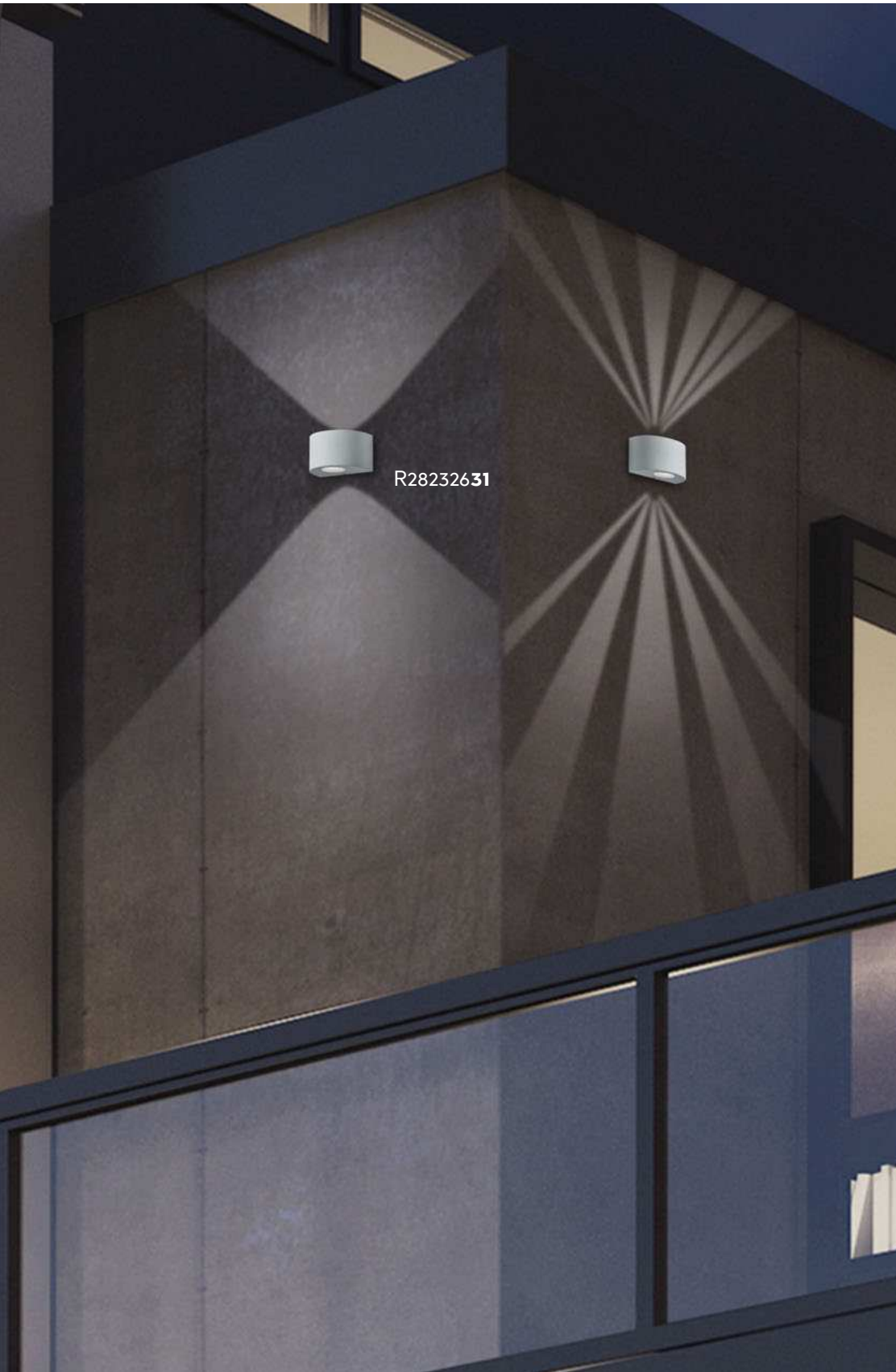

R28232631

Kunststoff  
plastic  
plastique  
kunststof  
plástico  
plastica  
plastic  
muovi  
plastik

**31** Weiß matt · white mat

**32** Schwarz matt · black mat

Incl. 2 x SMD-LED, 2 W  
2 x 200 lm, 3.000 K

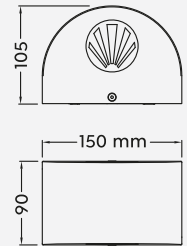

R28232632



# MOLINA

Aluminium Druckguss, Kunststoff  
diecast aluminium, plastic  
fonte d'aluminium, plastique  
gegoten aluminium, kunststof  
aluminio fundido, plástico  
pressofusione di alluminio, plastica  
fonta aluminiu, plastic  
valualumiini, muovi  
barwione aluminium, plastik

**42** Anthrazit · anthracite

Incl. 2 x SMD-LED, 4,6 W  
2 x 550 lm, 3.000 K

IP54

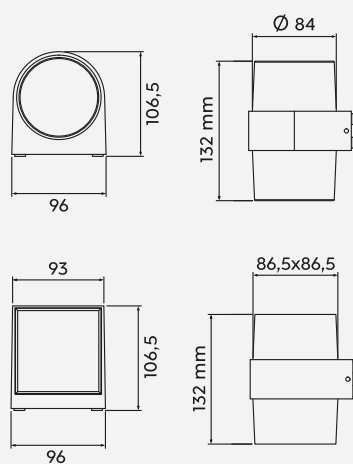

R22052142



R22062142





# LIMEIRA

Kunststoff  
plastic  
plastique  
kunststof  
plástico  
plastica  
plastic  
muovi  
plastik

**32** Schwarz matt · black mat

Incl. 2 x SMD-LED, 3,5 W  
2 x 380 lm, 3.000 K

IP44

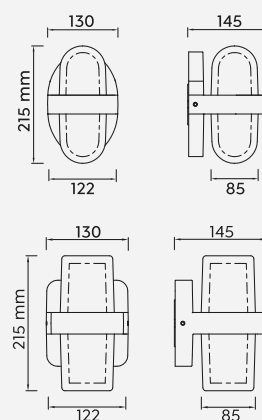

R24256232



R24266232



# PUNO

Kunststoff  
plastic  
plastique  
kunststof  
plástico  
plastica  
plastic  
muovi  
plastik

**32** Schwarz matt · black mat

Incl. SMD-LED, 8 W  
800 lm, 3.000 K

IP54

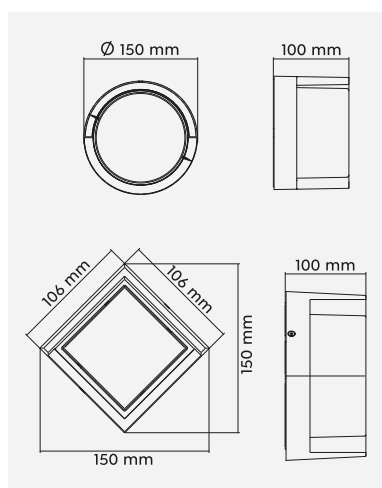

R27036132



R27026132

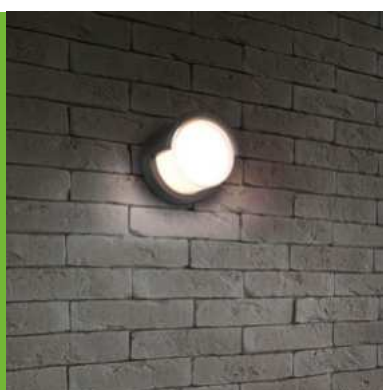



# PUELO

Aluminium Druckguss, Kunststoff  
diecast aluminium, plastic  
fonte d'aluminium, plastique  
gegoten aluminium, kunststof  
aluminio fundido, plástico  
pressofusione di alluminio, plastica  
fonta aluminiu, plastic  
valualumiini, muovi  
barwione aluminium, plastik

**31** Weiß matt · white mat

**32** Schwarz matt · black mat

Excl. 1 x E27, max. 10 W



IP44

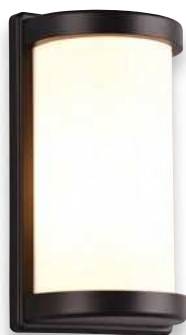
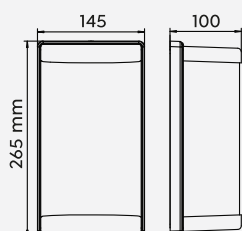

R21186132



R21186131



Empfohlen:  
recommended:

LED E27, 4,9 W  
470 lm, 3.000 K



987-60



# CALERA



Aluminium Druckguss, Kunststoff  
diecast aluminium, plastic  
fonte d'aluminium, plastique  
gegoten aluminium, kunststof  
aluminio fundido, plástico  
pressofusione di alluminio, plastica  
fonta aluminiu, plastic  
valualumiini, muovi  
barwione aluminium, plastik

**32** Schwarz matt · black mat

Incl. 1 x SMD-LED, 8 W  
800 lm, 3.000 K

IP54

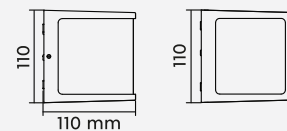

R27446132



# VENADO

Kunststoff  
plastic  
plastique  
kunststof  
plástico  
plastica  
plastic  
muovi  
plastik

**42** Anthrazit · anthracite

Incl. 1 x SMD-LED, 9,5 W  
1.000 lm, 3.000 K

IP54

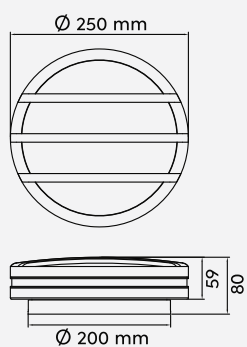

R24236142

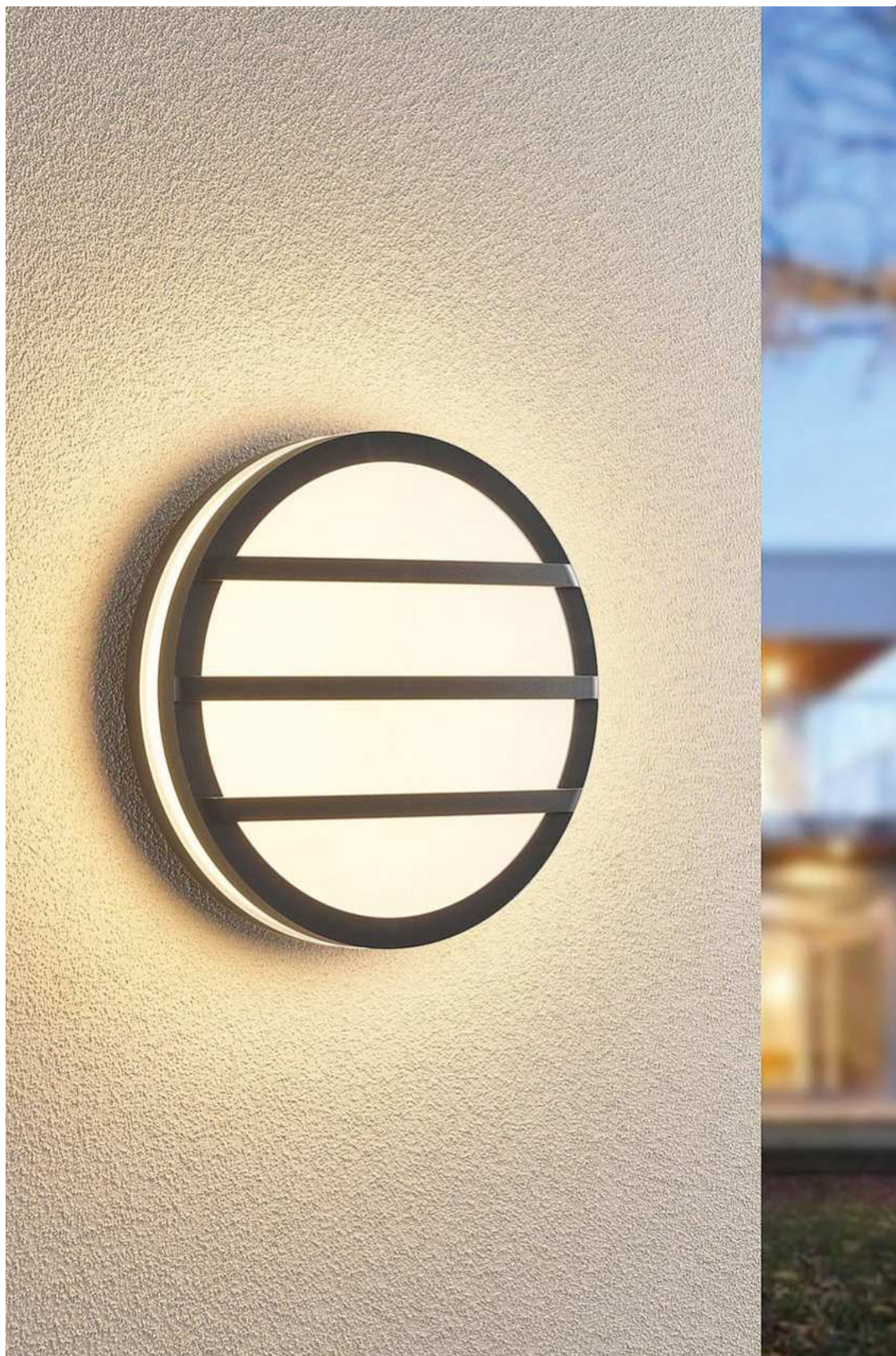

# MORENA

Kunststoff  
plastic  
plastique  
kunststof  
plástico  
plastica  
plastic  
muovi  
plastik

**32** Schwarz matt · black mat

Incl. 1 x SMD-LED, 14 W  
1.500 lm, 2.300 + 3.000 + 4.000 K

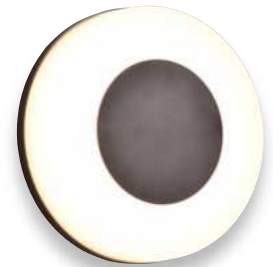
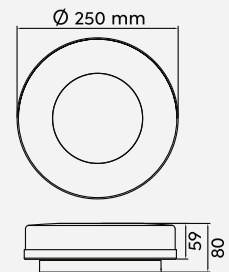

R24246132



## DIP SWITCH

Lichtfarben direkt an der Leuchte einstellbar

Colours directly adjustable at the lamp

Les couleurs de la lumière peuvent être réglées directement sur le luminaire

Lichtkleuren direct instelbaar op de lamp

Tonalidades de luz ajustables directamente en la lámpara

Colori della luce regolabili direttamente sulla lampada

Colori ale luminii reglabile direct de la bec

Valon väri asetettävissa suoraan valaisimesta

Barwy światła można ustawić bezpośrednio na oprawie

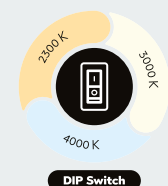

# CAMARO

Kunststoff  
 plastic  
 plastique  
 kunststof  
 plástico  
 plastica  
 plastic  
 muovi  
 plastik

**31** Weiß matt · white mat  
**42** Anthrazit · anthracite

Excl. 1 x E27, max. 12 W

**R60501031**  
**R60501042**

Excl. 2 x E27, max. 12 W

**R60502031**  
**R60502042**

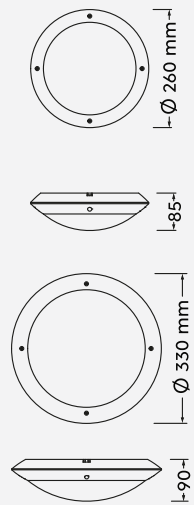

R60501031



R60501042



R60502031



R60502042

Empfohlen:  
 recommended:

LED E27, 4 W  
 320 lm, 3.000 K



986-60





# KENDAL

Kunststoff  
plastic  
plastique  
kunststof  
plástico  
plastica  
plastic  
muovi  
plastik

**42** Anthrazit · anthracite

Incl. SMD-LED, 11 W  
1.180 lm, 3.000 K

**R62151142**

Incl. SMD-LED, 12 W  
1.400 lm, 3.000 K

**R22151142**

**IP54**

**R22151142**

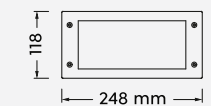
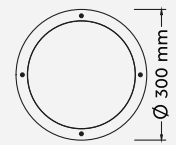

**R62151142**





### **Außenbeleuchtung ist viel mehr als nur funktional!**

Dank integriertem Akku sind die transportablen Leuchten flexibel und setzen spannende Akzente im Garten, auf dem Balkon oder der Terrasse - ganz ohne Kabel! Für die richtige Stimmung sorgen zusätzliche Highlights wie RGB-Farbwechsler oder Bluetooth-Funktion für kabelloses Musik hören. Die perfekte Beleuchtung für gemeinsame Abendstunden mit Familie und Freunden.

### **Outdoor lighting is much more than just functional!**

Integrated rechargeable batteries lets you flexibly use these easily transportable lights to accent your garden, balcony or terrace in an exciting way, all without any cables! Additional highlights like an RGB colour wheels and Bluetooth for streaming music wirelessly provide just the right mood. The perfect lighting for spending evening hours with family and friends.

### **L'éclairage extérieur est bien plus que simplement fonctionnel !**

Grâce à la batterie rechargeable intégrée, les lampes transportables sont flexibles et mettent des accents excitants dans le jardin, sur le balcon ou la terrasse –

sans aucun câble ! D'autres fonctions marquantes garantissent une bonne ambiance, telles que le changeur de couleurs RVB ou la fonction Bluetooth pour l'écoute de musique sans fil. L'éclairage parfait pour les soirées partagées avec la famille et les amis.

### **Buitenverlichting is veel meer dan enkel nuttig!**

Dankzij de geïntegreerde accu zijn de verplaatsbare lampen flexibel en zorgen voor mooie accenten in de tuin, op het balkon of op het terras, en dat helemaal zonder kabel! Voor de juiste stemming zorgen extra hoogtepunten zoals de RGB-kleurenwisselaar of Bluetooth-functie om draadloos muziek te beluisteren. De perfecte verlichting om 's avonds aangenaam te vertoeven met vrienden en familie.

### **¡La iluminación exterior es mucho más que algo funcional!**

Gracias a la batería integrada, las luces transportables son flexibles y aportan puntos de atención excitantes al jardín, al balcón o a la terraza - ¡y sin ningún tipo de cables! Se consigue el ambiente adecuado con otras características especiales adicionales como el modificador de color RGB o la función Bluetooth para escuchar música sin cables. La iluminación perfecta para pasar la tarde con la familia y los amigos.



### L'illuminazione esterna è molto più che funzionale!

Grazie alla batteria ricaricabile integrata, le lampade portatili sono flessibili e creano accenti emozionanti in giardino, sul balcone o sulla terrazza - senza cavi! Ulteriori punti di forza come il cambiacolori RGB o la funzione Bluetooth per l'ascolto di musica senza fili assicurano il giusto feeling. L'illuminazione perfetta per le ore serali da trascorrere insieme alla famiglia e agli amici.

### Iluminarea exterioară este mult mai mult decât funcțională!

Datorită acumulatorului integrat, lămpile transportabile sunt flexibile și oferă un aspect atrăgător în grădină, pe balcon sau pe terasă - fără cablu! Atmosfera potrivită este asigurată de jocurile suplimentare de lumină cum ar fi schimbarea culorilor RGB sau funcția Bluetooth pentru a asculta muzică fără cablu. Iluminarea perfectă pentru orele de seară cu familia și prietenii.

### Ulkovalaistus on paljon muutakin kuin vain toimintaa!

Integroidun ladattavan akun ansiosta siirrettävät valaisimet ovat joustavia ja muodostavat jännittäviä korostuksia puutarhaan, parvekkeelle tai terassille - ilman kaapeleita! Lisäkorostukset, kuten RGB-värvinvaihtajat tai Bluetooth-toiminto langattomaan musiikin kuuntelun, takaavat oikean ilmapiirin. Täydellinen valaistus illanviettoon yhdessä perheen ja ystävien kanssa.

### Oświetlenie zewnętrzne to znacznie więcej niż tylko funkcjonalność!

Dzięki akumulatorowi przenośne lampy są elastyczne w ustawieniu i tworzą ekscytujące akcenty w ogrodzie, na balkonie lub tarasie - bez żadnych kabli! Odpowiedni nastrój zapewnią dodatkowe urządzenia, takie jak zmieniające kolorów RGB lub funkcja Bluetooth do bezprzewodowego słuchania muzyki. Doskonałe oświetlenie wspólnych wieczorów z rodziną i przyjaciółmi.

# SUAREZ

Metall  
metal  
metale  
metaal  
metal  
metallo  
metal  
metalli  
metal

**10** Rot · red  
**31** Weiß matt · white mat  
**32** Schwarz matt · black mat  
**49** Pistaziengrün · pistachio green

Incl. 1 x SMD-LED, 2 W  
200 lm, 3.000 K

R47706110  
R47706131  
R47706132  
R47706149



Incl. 1 x SMD-LED, 1,5 W  
200 lm, 3.000 K

R57706110  
R57706131  
R57706132  
R57706149

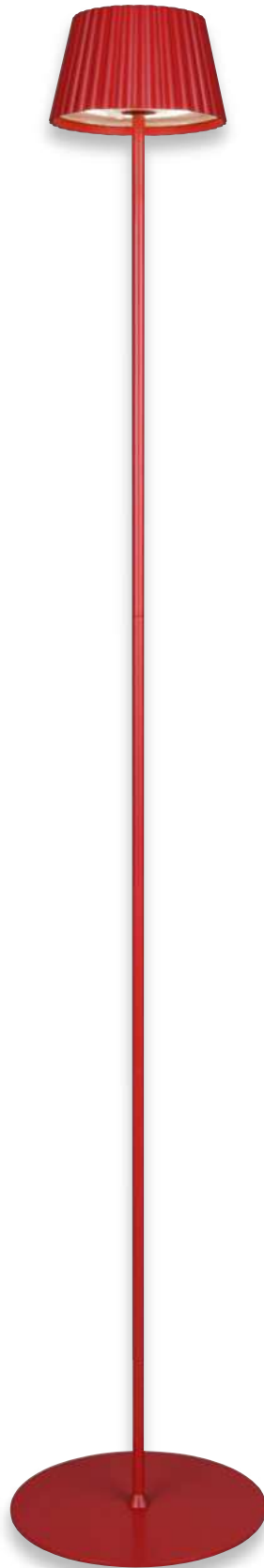
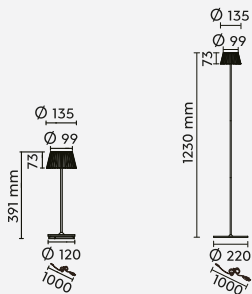

R47706110

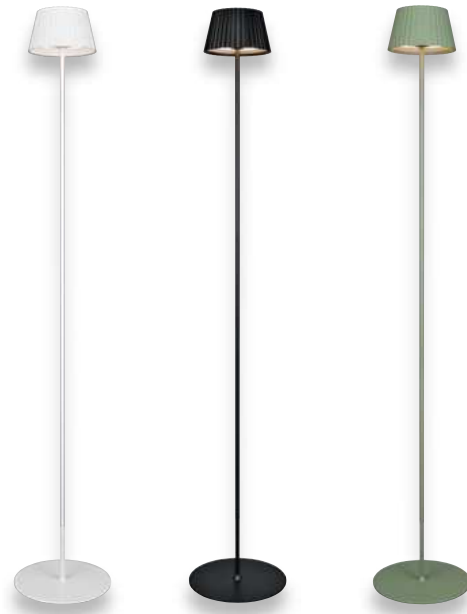

R47706131

R47706132

R47706149

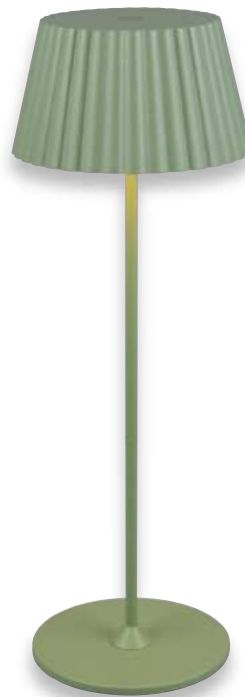

R57706149



R57706132

R57706131

R57706110



Inklusive Ladestation  
Charging station included  
Station de recharge incluse  
Laadstation inbegrepen  
Estación de carga incluida  
Stazione di ricarica inclusa  
Stație de încărcare inclusă  
Latausasema sisältyy  
W zestawie stacja ładowująca



USB-C Anschluss mit Ladefunktion  
Recharging USB-C connection  
Entrée USB-C de rechargement  
Opladende USB-C aansluiting  
Conexión USB-C de recarga  
Connessione USB-C di ricarica  
Conexiune USB-C reîncărcare  
Lataaminen USB-C-liitäntä  
Ładowania USB-C połączenie



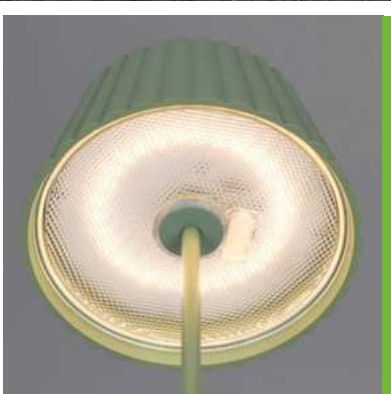
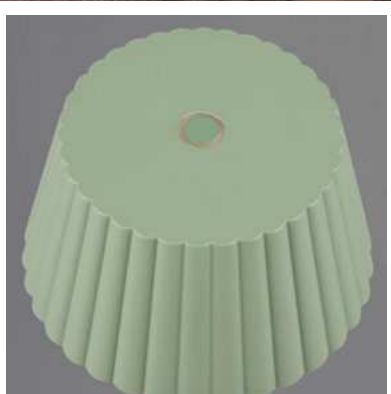

# FUNGO

Aluminium Druckguss, Kunststoff  
 diecast aluminium, plastic  
 fonte d'aluminium, plastique  
 gegoten aluminium, kunststof  
 aluminio fundido, plástico  
 pressofusione di alluminio, plastica  
 fonta aluminiu, plastic  
 valualumiini, muovi  
 barwione aluminium, plastik

**10** Rot · red  
**31** Weiß matt · white mat  
**42** Anthrazit · anthracite  
**49** Pistaziengrün · pistachio green  
**66** Sand · sable

Incl. 1 x SMD-LED, 2 W  
 200 lm, 3.000 + 4.000 + 6.500 K

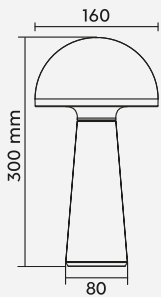

R57716110



R57716131



R57716142



R57716149



R57716166



Inklusive Ladestation  
 Charging station included  
 Station de recharge incluse  
 Laadstation inbegrepen  
 Estación de carga incluida  
 Stazione di ricarica inclusa  
 Stație de încărcare inclusă  
 Latausasema sisältyy  
 W zestawie stacja ładowająca





# RICARDO

Kunststoff  
 plastic  
 plastique  
 kunststof  
 plástico  
 plastica  
 plastic  
 muovi  
 plastik

- 10** Rot · red
- 31** Weiß matt · white mat
- 32** Schwarz matt · black mat
- 49** Pistaziengrün · pistachio green
- 66** Sand · sable
- 77** Ultimate Grau · ultimate grey

Incl. 1 x SMD-LED, 1,7 W  
 240 lm, 3.000 K

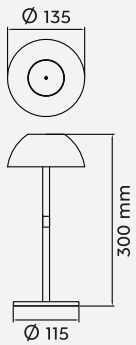

R54106110



R54106131



R54106132



R54106149

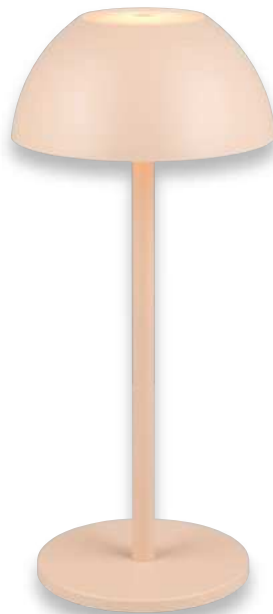

R54106166



R54106177

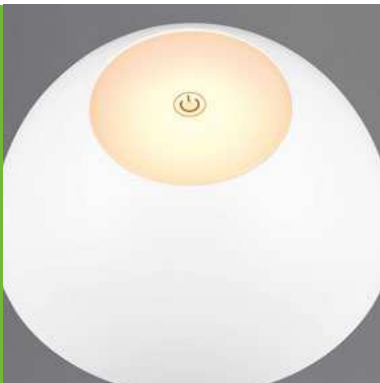

USB-C Anschluss mit Ladefunktion  
 Recharging USB-C connection  
 Entrée USB-C de rechargement  
 Opladende USB-C aansluiting  
 Conexión USB-C de recarga  
 Connessione USB-C di ricarica  
 Conexiune USB-C reîncărcare  
 Lataaminen USB-C-liitäntä  
 ładowania USB-C połączenie





Metall, Kunststoff  
 metal, plastic  
 metale, plastique  
 metaal, kunststof  
 metal, plástico  
 metallo, plastica  
 metal, plastic  
 metalli, muovi  
 metal, plastik

**31** Weiß matt · white mat  
**32** Schwarz matt · black mat  
**77** Ultimate Grau · ultimate grey

Incl. 1 x SMD-LED, 1,5 W  
 130 lm, 2.700 + 4.000 + 6.000 K

R54096131  
 R54096132  
 R54096177

Incl. 6 x SMD-LED, 6 x 1,5 W  
 6 x 130 lm, 2.700 + 4.000 + 6.000 K

R54096631  
 R54096632  
 R54096677



R54096131



R54096132



R54096177

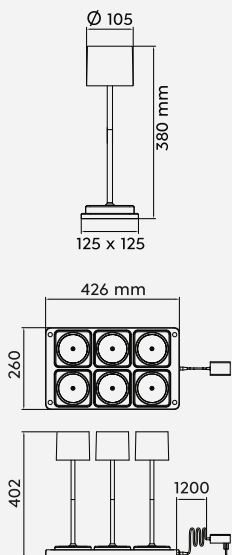

6er Set / Set 6



R54096631



R54096632



R54096677



Inklusive Ladestation  
 Charging station included  
 Station de recharge incluse  
 Laadstation inbegrepen  
 Estación de carga incluida  
 Stazione di ricarica inclusa  
 Stație de încărcare inclusă  
 Latausasema sisältyy  
 W zestawie stacja ładowująca



Lichtfarbe einstellbar  
 Adjustable light color  
 Couleur de lumière réglable  
 Lichtkleur instelbaar  
 Color de luz regulable  
 Colore della luce regolabile  
 Lumina colorata reglabila  
 Värilämpötila säädettävissä  
 Regulowana barwa światła



# ELLIOT

Kunststoff  
plastic  
plastique  
kunststof  
plástico  
plastica  
plastic  
muovi  
plastik

**31** Weiß matt · white mat  
**32** Schwarz matt · black mat  
**49** Pistaziengrün · pistachio green

Incl. 1 x SMD-LED, 2 W  
180 lm, 3.000 K

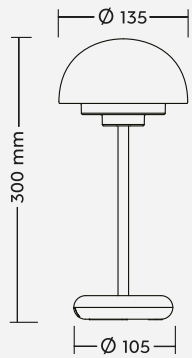

R52306132



R52306149

R52306131



USB-C



USB-C Anschluss mit Ladefunktion  
Recharging USB-C connection  
Entrée USB-C de rechargement  
Opladende USB-C aansluiting  
Conexión USB-C de recarga  
Connessione USB-C di ricarica  
Conexiune USB-C reîncărcare  
Lataaminen USB-C-liitäntä  
ładowania USB-C połączenie

# LENNON

Kunststoff  
plastic  
plastique  
kunststof  
plástico  
plastica  
plastic  
muovi  
plastik

- 01** Weiß · white
- 02** Schwarz · black
- 49** Pistaziengrün · pistachio green
- 77** Ultimate Grau · ultimate grey
- 83** Illuminate Gelb · illuminate yellow

Incl. 1 x SMD-LED, 2 W  
180 lm, 3.000 K

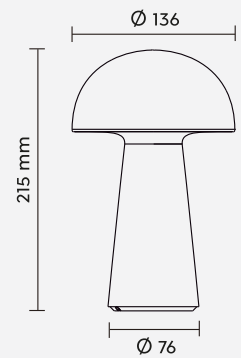

USB-C



R52176102



R52176101



R52176177



# MARTINEZ

Metall, Kunststoff  
metal, plastic  
metale, plastique  
metaal, kunststof  
metal, plástico  
metallo, plastica  
metal, plastic  
metalli, muovi  
metal, plastik

**31** Weiß matt · white mat

**32** Schwarz matt · black mat

Incl. 1 x SMD-LED, 2,2 W  
250 lm, 2.700 - 6.500 K

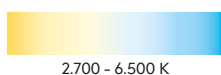
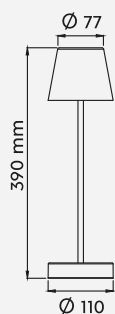

R54086131

R54086132



Lichtfarbe stufenlos einstellbar  
Light color infinitely variable  
Couleur de lumière infiniment variable  
Lichtkleur traploos instelbaar  
Color de luz infinitamente variable  
Colore della luce infinitamente variabile  
Culoare lumină infinit variabilă  
Valon väri portaattomasti  
Jasny kolor bezstopniowo

# TORREZ

Kunststoff  
 plastic  
 plastique  
 kunststof  
 plástico  
 plastica  
 plastic  
 muovi  
 plastik

**31** Weiß matt · white mat  
**32** Schwarz matt · black mat  
**77** Ultimate Grau · ultimate grey

Incl. 1 x SMD-LED, 2 W  
 180 lm, 3.000 + 4.000 + 5.000 K

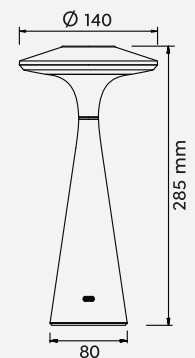

R57726131

R57726132



R57726177



Lichtfarbe einstellbar  
 Adjustable light color  
 Couleur de lumière réglable  
 Lichtkleur instelbaar  
 Color de luz regulable  
 Colore della luce regolabile  
 Lumina colorata reglabila  
 Väriämpötila säädettävissä  
 Regulowana barwa światła



USB-C Anschluss mit Ladefunktion  
 Recharging USB-C connection  
 Entrée USB-C de rechargement  
 Opladende USB-C aansluiting  
 Conexión USB-C de recarga  
 Connessione USB-C di ricarica  
 Conexiune USB-C reîncărcare  
 Lataaminen USB-C-liitäntä  
 ładowania USB-C połączenie



# SANCHEZ

Kunststoff  
 plastic  
 plastique  
 kunststof  
 plástico  
 plastica  
 plastic  
 muovi  
 plastik

**31** Weiß matt · white mat  
**42** Anthrazit · anthracite

Incl. 1 x SMD-LED, 2,1 W  
 190 lm, 3.000 + 4.000 + 5.000 K

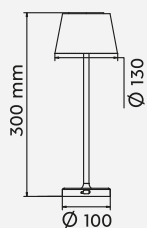
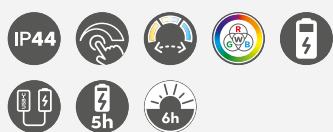

R54126131



R54126142



3.000 K

4.000 K

5.000 K



USB-C Anschluss mit Ladefunktion  
 Recharging USB-C connection  
 Entrée USB-C de rechargement  
 Opladende USB-C aansluiting  
 Conexión USB-C de recarga  
 Connessione USB-C di ricarica  
 Conexiune USB-C reîncărcare  
 Lataaminen USB-C-liitäntä  
 ładowania USB-C połączenie







# DORA

Kunststoff  
plastic  
plastique  
kunststof  
plástico  
plastica  
plastic  
muovi  
plastik

01 Weiß · white

Incl. 1 x SMD-LED, 1,5 W  
90 lm, 3.000 K

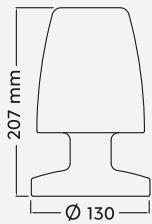

R57051101



Ladezeit  
Charging time  
Temps de charge  
Oplaaadtijd  
Tiempo de carga  
Tempo di carica  
Timp de incarcare  
Latausaika  
Czas ładowania



Leuchtdauer  
Luminous period  
Durée d'éclairage  
Brandtijd  
Tiempo de iluminación  
Tempo di durata  
Perioada de iluminare  
Valaistusaika  
Czas świecenia

Kunststoff  
 plastic  
 plastique  
 kunststof  
 plástico  
 plastica  
 plastic  
 muovi  
 plastik

**01** Weiß · white

Incl. 1 x SMD-LED, 1,5 W  
 90 lm, 3.000 K

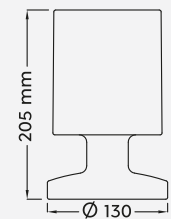

R57071101



Akkubetrieb  
 Rechargeable battery operated  
 Fonctionnement sur batteries rechargeable  
 Oplaadbare accu  
 Batería recargable  
 Batteria Ricaricabile  
 Operabil prin baterie reincarcabila  
 Ladattava akku  
 Akumulator zasilany bateryjnie



USB Anschluss mit Ladefunktion  
 Recharging USB connection  
 Entrée USB de rechargement  
 Opladende USB aansluiting  
 Conexión USB de recarga  
 Connessione USB di ricarica  
 Conexiune USB reîncărcare  
 Lataaminen USB-liitäntä  
 ładowania USB połączenie

# PALMAS

Kunststoff  
plastic  
plastique  
kunststof  
plástico  
plastica  
plastic  
muovi  
plastik

**01** Weiß · white

Incl. 1 x RGBW-LED, 1,5 W  
45 lm, 3.000 K

**R55101101**

Incl. 1 x RGBW-LED, 3 W  
90 lm, 3.000 K

**R45101101**

Incl. 1 x RGBW-LED, 4,5 W  
120 lm, 3.000 K

**R45101901**



**R55101101**



**R45101101**



**R45101901**

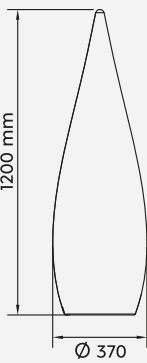
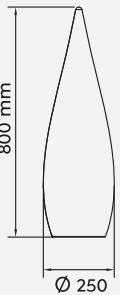
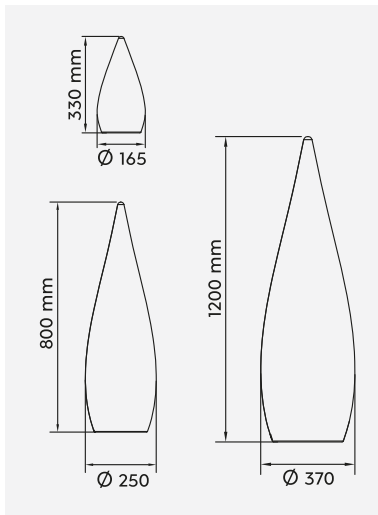

RGBW Farbwechsler  
RGBW Colorchanging  
Changement de couleur RGBW  
RGBW Kleurverandering  
Cambio de color RGBW  
Cambia colore RGBW  
Schimbator de culoare RGBW  
Värinvaihto RGB  
Zmieniający kolor RGBW



Akkubetrieb  
Rechargeable battery operated  
Fonctionnement sur batteries rechargeable  
Oplaadbare accu  
Batería recargable  
Batteria Ricaricabile  
Operabil prin baterie reincarcabila  
Ladattava akku  
Akumulator zasilany bateryjnje  
Şarj edilebilir pilli



Ladezeit  
Charging time  
Temps de charge  
Oplaaftijd  
Tiempo de carga  
Tempo di carica  
Timp de incarcare  
Latausaika  
Czas ładowania



Leuchtdauer  
Luminous period  
Durée d'éclairage  
Brandtijd  
Tiempo de iluminación  
Tempo di durata  
Perioada de iluminare  
Valaistusaika  
Czas świecenia

# ARUBA

Kunststoff  
plastic  
plastique  
kunststof  
plástico  
plastica  
plastic  
muovi  
plastik

01 Weiß · white

Incl. 1 x RGBW-LED, 1 W  
70 lm, 3.000 K

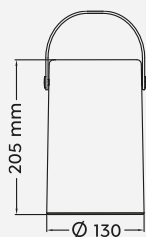

R57080101



USB Anschluss mit Ladefunktion  
Recharging USB connection  
Entrée USB de rechargement  
Opladende USB aansluiting  
Conexión USB de recarga  
Connessione USB di ricarica  
Conexiune USB reîncărcare  
Lataaminen USB-liitäntä  
Ładowania USB połączenie  
şarj USB bađlantı



Ladezeit  
Charging time  
Temps de charge  
Oplaadtijd  
Tiempo de carga  
Tempo di carica  
Timp de încarcare  
Latausaika  
Czas ładowania



Leuchtdauer  
Luminous period  
Durée d'éclairage  
Brandtijd  
Tiempo de iluminación  
Tempo di durata  
Perioada de iluminare  
Valaistus aika  
Czas świecenia

# JAMAICA

Kunststoff  
plastic  
plastique  
kunststof  
plástico  
plastica  
plastic  
muovi  
plastik

01 Weiß · white

Incl. 1 x RGBW-LED, 2,5 W  
25 lm, 3.000 K

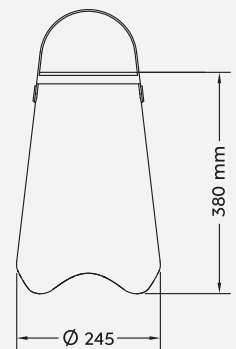

## LIGHT & SOUND



R55086101

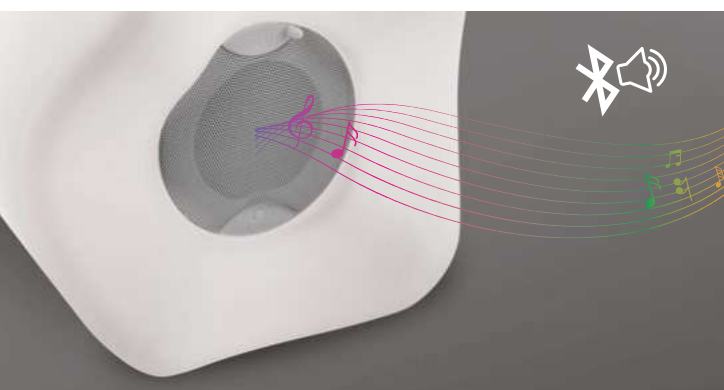

# BOLO

Kunststoff  
plastic  
plastique  
kunststof  
plástico  
plastica  
plastic  
muovi  
plastik

54 rauchfarbig · smoke

Excl. 1 x E27, max. 40 W



R57042054



R57043054



R57044054

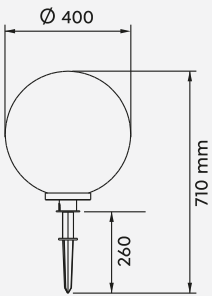
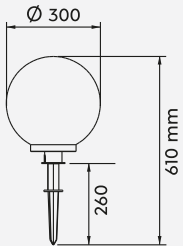
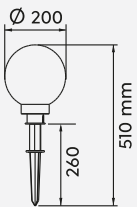

Empfohlen:  
recommended:

Filament LED  
E27, 4 W  
470 lm, 2.700 K

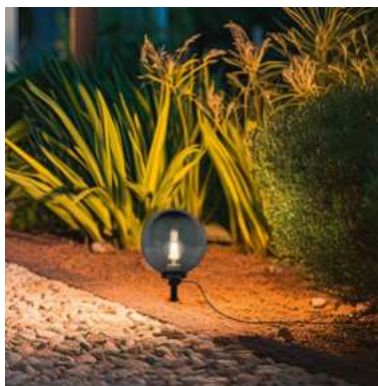





# BOLO

Kunststoff  
plastic  
plastique  
kunststof  
plástico  
plastica  
plastic  
muovi  
plastik

01 Weiß · white

Excl. 1 x E27, max. 23 W

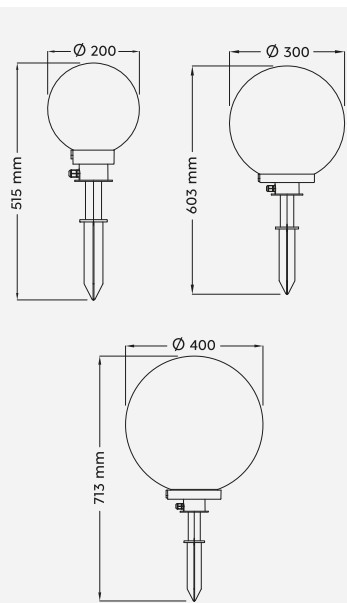

R57043001



R57042001



R57044001

Empfohlen:  
recommended:

LED E27, 4,9 W  
470 lm, 3.000 K



987-60







### **Sonne Tanken!**

Solarleuchten nutzen ausschließlich die Kraft der Sonne um Licht zu erzeugen. Dabei sind sie extrem umwelt-schonend, sparsam und gleichermaßen praktisch, da sie weder Steckdosen noch einen Anschluss ans Stromnetz benötigen. In Kombination mit moderner LED-Technik bieten Solarleuchten ideales Licht für Haus und Garten.

### **Soak up the sun!**

Solar lamps exclusively use the power of the sun to generate light. At the same time they are extremely environmentally friendly and economical as well as practical, as they need neither sockets nor a connection to the mains supply. In combination with modern LED technology, solar lamps provide an ideal light for home and garden.

### **Faites le plein de soleil !**

Les lampes solaires utilisent exclusivement l'énergie du soleil pour générer de la lumière. En même temps, elles sont extrêmement écologiques, économiques et tout aussi pratiques, car elles ne nécessitent ni prise de courant ni raccordement au réseau électrique. En combinaison avec la technologie LED moderne, les lampes solaires fournissent une lumière idéale pour la maison et le jardin.

### **Doe zon op!**

Zonnelampen maken uitsluitend gebruik van de kracht van de zon om licht te produceren. Daarbij zijn ze extreem milieuvriendelijk, zuinig en in gelijke mate praktisch, omdat ze noch een stopcontact noch een aansluiting op het stroomnet nodig hebben. In combinatie met moderne ledtechniek bieden z onnelampen ideaal licht voor huis en tuin.

### **¡Disfrute del sol!**

Las luces solares usan exclusivamente la energía del sol para generar luz. Al mismo tiempo, son extremadamente ecológicas, económicas e igualmente prácticas, y no necesitan ni enchufes ni conexión a la corriente. En combinación con las modernas técnicas LED, las luces solares ofrecen una luz ideal para la casa y el jardín.



### Prendete un po' di sole!

Le lampade solari utilizzano esclusivamente la potenza del sole per generare luce. Allo stesso tempo sono estremamente rispettose dell'ambiente, economiche e pratiche in quanto non richiedono né presa di corrente, né un collegamento alla rete elettrica. In combinazione con la moderna tecnologia LED, le lampade solari forniscono una luce ideale per la casa e il giardino.

### Alimentați cu soare!

Lămpile solare se folosesc în exclusivitate de energia soarelui pentru a genera lumină. În acest context sunt extrem de ecologice, economice și practice în același timp, deoarece nu necesită nici prize și nici conectarea la o rețea electrică. În combinație cu tehnologia modernă LED, lămpile solare oferă lumina ideală pentru casă și grădină.

### Ajattele aurinkoa!

Aurinkovalaisimet käyttävät auringon energiaa valon tuottamiseen. Samalla ne ovat erittäin ympäristöystävällisiä, taloudellisia ja myös käytännöllisiä, koska ne eivät vaadi pistorasioita tai liitäntää sähköverkkoon. Yhdessä modernin LED-tekniikan kanssa aurinkovalaisimet tarjoavat ihanteellisen valaistuksen kotiin ja puutarhaan.

### Nałapać energii słonecznej!

Lampy solarne wykorzystują moc słońca do generowania światła. Są one przy tym niezwykle przyjazne dla środowiska, ekonomiczne i jednocześnie praktyczne, ponieważ nie wymagają gniazd ani podłączenia do sieci elektrycznej. W połączeniu z nowoczesną technologią LED lampy solarne zapewniają idealne oświetlenie domu i ogrodu.

Kunststoff  
 plastic  
 plastique  
 kunststof  
 plástico  
 plastica  
 plastic  
 muovi  
 plastik

**42** Anthrazit · anthracite

Incl. 1 x SMD-LED, 4,5 W  
 290 lm, 3.000 K



R22251142



R42251142

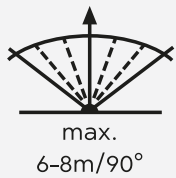
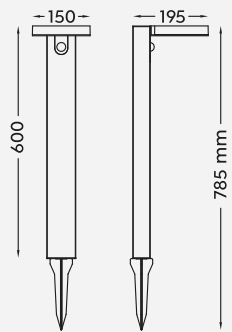
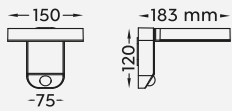

Ladezeit  
 Charging time  
 Temps de charge  
 Oplaadtijd  
 Tiempo de carga  
 Tempo di carica  
 Timp de incarcare  
 Latausaika  
 Czas ładowania



Leuchtdauer  
 Luminous period  
 Durée d'éclairage  
 Brandtijd  
 Tiempo de iluminación  
 Tempo di durata  
 Perioada de iluminare  
 Valaistusaika  
 Czas świecenia





Kunststoff  
 plastic  
 plastique  
 kunststof  
 plástico  
 plastica  
 plastic  
 muovi  
 plastik

**42** Anthrazit · anthracite

Incl. 1 x SMD-LED, 4,5 W  
 290 lm, 3.000 K



R22261142

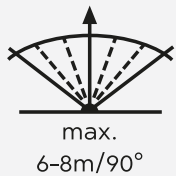
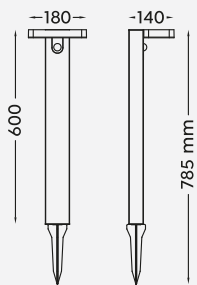
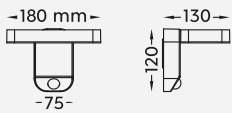

R42261142



Ladezeit  
 Charging time  
 Temps de charge  
 Oplaadtijd  
 Tiempo de carga  
 Tempo di carica  
 Timp de incarcare  
 Latausaika  
 Czas ładowania



Leuchtdauer  
 Luminous period  
 Durée d'éclairage  
 Brandtijd  
 Tiempo de iluminación  
 Tempo di durata  
 Perioada de iluminare  
 Valaistusaika  
 Czas świecenia





Kunststoff  
 plastic  
 plastique  
 kunststof  
 plástico  
 plastica  
 plastic  
 muovi  
 plastik

**42** Anthrazit · anthracite

Incl. 1 x SMD-LED, 5 W  
 200 lm, 3.000 K

**R22241142**



Incl. 1 x SMD-LED, 4,8 W  
 340 lm, 3.000 K

**R22281142**

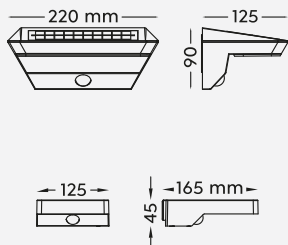

**FOMOSA**

**R22241142**



**MENDOZA**

**R22241142**

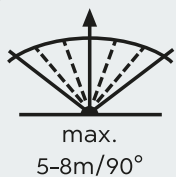

Ladezeit  
 Charging time  
 Temps de charge  
 Oplaadtijd  
 Tiempo de carga  
 Tempo di carica  
 Timp de încarcare  
 Latausaika  
 Czas ładowania

# SALTA

Metall, Acryl  
metal, acryl  
metale, acryl  
metaal, acryl  
metal, acrílico  
metallo, acrilico  
metal, acrilic  
metalli, akryyli  
metal, akryl

**07** Nickel matt · nickel mat

**42** Anthrazit · anthracite

Incl. 1 x SMD-LED, 3 W  
165 lm, 3.000 K

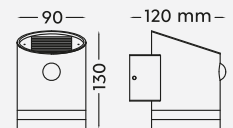

R22231142



Leuchtdauer  
Luminous period  
Durée d'éclairage  
Brandtijd  
Tiempo de iluminación  
Tempo di durata  
Perioada de iluminare  
Valaistusaika  
Czas świecenia

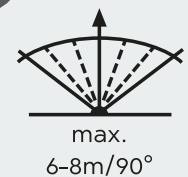

# SILVA

Kunststoff  
plastic  
plastique  
kunststof  
plástico  
plastica  
plastic  
muovi  
plastik

01 Weiß · white

Incl. 1 x SMD-LED, 0,1 W

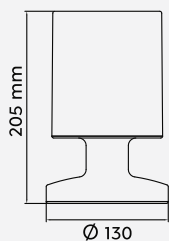

R54076101



Ladezeit  
Charging time  
Temps de charge  
Oplaadtijd  
Tiempo de carga  
Tempo di carica  
Timp de incarcare  
Latausaika  
Czas ładowania



Leuchtdauer  
Luminous period  
Durée d'éclairage  
Brandtijd  
Tiempo de iluminación  
Tempo di durata  
Perioada de iluminare  
Valaistusaika  
Czas świecenia



USB-C



R54066101

Kunststoff  
 plastic  
 plastique  
 kunststof  
 plástico  
 plastica  
 plastic  
 muovi  
 plastik

01 Weiß · white

Incl. 1 x RGBW-LED, 0,1 W

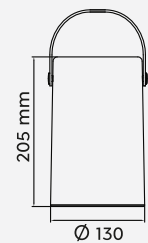

USB-C Anschluss mit Ladefunktion  
 Recharging USB-C connection  
 Entrée USB-C de rechargement  
 Opladende USB-C aansluiting  
 Conexión USB-C de recarga  
 Connessione USB-C di ricarica  
 Conexiune USB-C reîncărcare  
 Lataaminen USB-C-liitäntä  
 ładowania USB-C połączenie



RGBW Farbwechsler  
 RGBW Colorchanging  
 Changement de couleur RGBW  
 RGBW Kleurverandering  
 Cambio de color RGBW  
 Cambia colore RGBW  
 Schimbator de culoare RGBW  
 Värinvaihto RGB  
 Zmieniający kolor RGBW



Kunststoff  
 plastic  
 plastique  
 kunststof  
 plástico  
 plastica  
 plastic  
 muovi  
 plastik

11 Grau · grey

Incl. SMD-LED, 0,02 W

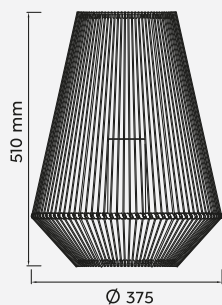
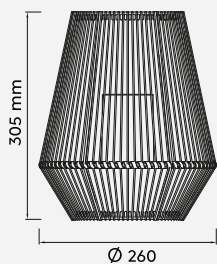

R55256111



R55256911



Flammen-Effekt  
 Flame effect  
 Effet de flamme  
 Vlammeneffect  
 Efecto de llamas  
 Effetto fiamma  
 Efect de flacără  
 Liekkitehoste  
 Efekt płomienia



Leuchtdauer  
 Luminous period  
 Durée d'éclairage  
 Brandtijd  
 Tiempo de iluminación  
 Tempo di durata  
 Perioada de iluminare  
 Valaistusaika  
 Czas świecenia



Ladezeit  
 Charging time  
 Temps de charge  
 Oplaadtijd  
 Tiempo de carga  
 Tempo di carica  
 Timp de incarcare  
 Latausaika  
 Czas ładowania





# SANTANA

Aluminium Druckguss, Kunststoff  
diecast aluminium, plastic  
fonte d'aluminium, plastique  
gegoten aluminium, kunststof  
aluminio fundido, plástico  
pressofusione di alluminio, plastica  
fonta aluminiu, plastic  
valualumiini, muovi  
barwione aluminium, plastik

**32** Schwarz matt / Braun ·  
black mat / brown

Incl. 1 x SMS-LED, 0,1 W

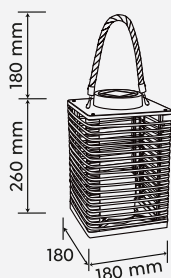

R55346132



Leuchtdauer  
Luminous period  
Durée d'éclairage  
Brandtijd  
Tiempo de iluminación  
Tempo di durata  
Perioada de iluminare  
Valaistusaika  
Czas świecenia



Ladezeit  
Charging time  
Temps de charge  
Oplaadtijd  
Tiempo de carga  
Tempo di carica  
Timp de încarcare  
Latausaika  
Czas ładowania





# CAMPUS

Metall, Kunststoff  
metal, plastic  
metale, plastique  
metaal, kunststof  
metal, plástico  
metallo, plastica  
metal, plastic  
metalli, muovi  
metal, plastik

**32** Schwarz matt · black mat

Incl. 3 x SMD-LED, 0,1 W

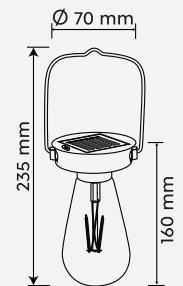

R35146132



Ladezeit  
Charging time  
Temps de charge  
Oplaadtijd  
Tiempo de carga  
Tempo di carica  
Timp de incarcare  
Latausaika  
Czas ładowania



Leuchtdauer  
Luminous period  
Durée d'éclairage  
Brandtijd  
Tiempo de iluminación  
Tempo di durata  
Perioada de iluminare  
Valaistusaika  
Czas świecenia



3er Set / Set 3

Kunststoff  
 plastic  
 plastique  
 kunststof  
 plástico  
 plastica  
 plastic  
 muovi  
 plastik

**01** Weiß · white

Incl. 1 x RGBW-LED, 0,5 W

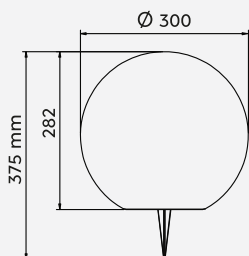
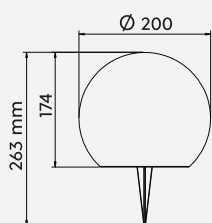

R55326101

R55326901



RGBW Farbwechsler  
 RGBW Colorchanging  
 Changement de couleur RGBW  
 RGBW Kleurverandering  
 Cambio de color RGBW  
 Cambia colore RGBW  
 Schimbator de culoare RGBW  
 Värinvalitto RGB  
 Zmieniający kolor RGBW



# Produkteigenschaften · Features

Caractéristiques · Kenmerken · Acabados ·  
Caratteristiche · Caracteristici · Ominaisuudet · Cechy



Schalter · Switch  
Interrupteur · Schakelaar · Interruptor ·  
Interruttore · Intrerupator · Kytkin ·  
Przełącznik



Fernbedienung · Remote control  
Commande à distance · Afstandsbediening ·  
Mando a distancia · Comando a distanza ·  
Telecomanda · Kauko-ohjain · Pilot



Integrierter Dimmer · Integrated dimmer  
Variateur intégré · Geïntegreerde dimmer ·  
Regulador integrado · Dimmer integrato ·  
Variator de lumina integrat · Integroitu himmennin ·  
Wbudowany ściemniacz



RGBW Farbwechsler · RGBW Colorchanging  
Changement de couleur RGBW ·  
RGBW Kleurverandering · Cambio de color RGBW ·  
Cambia colore RGBW · Schimbator de culoare  
RGBW · Värvinvaihto RGB · Zmieniający kolor RGBW



Schwenkbar · Tilttable  
Pivotant · Draaibaar · Pivotante ·  
Girevole · Pivotant · Suunnattava · Skretny



Steckdose · Plug  
Prise · Stekker · Enchufe · Spina ·  
Priza · Katkaisin · Gniazdko



Bewegungssensor · Motion sensor  
Décteur de mouvement · Bewegungssensor ·  
Sensor de movimiento · Sensore di movimento ·  
Senzor de mişcare · Liiketunnistin · Czujnik ruchu



Dämmerungssensor · Dusk sensor  
Décteur de crépuscule · Schemeringsensor ·  
Sensor de oscuridad · Sensore crepuscolare ·  
Senzor de lumina/amurg · Hämärätunnistin ·  
Czujnik zmierzchowy



4 fach TOUCH · 4 level Touch function  
Interrupteur tactile 4 niveaux ·  
Touch schakelaar 4 niveaus · Función Táctil 4 nivel ·  
Interruttore touch 4 livelli · Intrerupator tactil  
4 nivele · Kosketuskäyttöinen 4 taso ·  
Funkcja dotykowa 4 poziomy



Up and down Beleuchtung ·  
Up and Down lighting  
Point lumineux en haut et en bas · Lichtpunt boven  
en onder · Luz de arriba y abajo · Luce su e giù ·  
Sus și în jos lumina · Ylös ja alas valoa ·  
W górę iw dół światło



Ohne Leuchtmittel · Lamp(s) excluded  
Sans ampoule(s) · Zonder lichtbron(nen) ·  
Sin bombilla(s) · Lampadina Esclusa · Fara bec (s) ·  
Ilman polttimo (s) · Bez żarówki (s)



USB Anschluss · USB connection  
Entrée USB · USB aansluiting · Conexión USB ·  
Connessione USB · Conexiune USB ·  
USB-liitäntä · Połączenie USB



Lichtfarbe stufenlos einstellbar ·  
Light color infinitely variable  
Couleur de lumière infiniment variable ·  
Lichtkleur traploos instelbaar · Color de luz  
infinitamente variable · Colore della luce  
infinitamente variabile · Culoare lumină infinit  
variabilă · Valon väri portaattomasti ·  
Jasny kolor bezstopniowo



Bluetooth Lautsprecher ·  
Bloutooth loudspeaker  
Haut-parleur bluetooth · Bluetooth luidspreker ·  
Altavoz de bluetooth · Altoparlante bluetooth ·  
Difuzor Bluetooth · Bluetooth-kaiutin ·  
Głośnik Bluetooth



USB Anschluss mit Ladefunktion ·  
Recharging USB connection  
Entrée USB de rechargement · Opladende USB  
aansluiting · Conexión USB de recarga ·  
Connessione USB di ricarica · Conexiune USB  
reîncărcare · Lataaminen USB-liitäntä ·  
Ładowania USB połączenie



Memory Funktion · Memory function  
fonction mémoire · Geheugen functie ·  
Función de memoria · Funzione memorizzazione ·  
functia memorie · Muistitoiminto · Funkcja pamięci



Akkubetrieb · Rechargeable battery operated  
Fonctionnement sur batteries rechargeable ·  
Oplaadbare accu · Batería recargable ·  
Bateria Ricaricabile · Operabil prin baterie  
reincarcabila · Ladattava akku ·  
Akumulator zasilany bateryjnie



Lichtfarbe einstellbar · Adjustable light color  
Couleur de lumière réglable · Lichtkleur instelbaar ·  
Color de luz regulable · Colore della luce regolabile ·  
Lumina colorata reglabila · Värlämpötila säädettä-  
vissä · Regulowana barwa światła



DIP SWITCH  
Lichtfarben direkt an der Leuchte einstellbar ·  
Colours directly adjustable at the lamp  
Les couleurs de la lumière peuvent être réglées  
directement sur le luminaire · Lichtkleuren direct  
instelbaar op de lamp · Tonalidades de luz  
ajustables directamente en la lámpara · Colori  
della luce regolabili direttamente sulla lampada ·  
Colori ale luminii reglabile direct de la bec · Valon  
väri asetettävissa suoraan valaisimesta · Barwy  
światła można ustawić bezpośrednio na oprawie



Sensordimmer · Sensor dimmer  
Variateur tactile · Touchdimmer ·  
Regulador con sensor · Touchdimmer ·  
Variator cu senzor · Kosketushimmennin ·  
Czujnik ściemniania



Kippbar · Tilttable  
Inclinable · Kantelbaar · Basculante ·  
Inclinabile · Basculant · Kallistettava · Uchylny



### Ladezeit · Charging time

Temps de charge · Oplaadtijd · Tiempo de carga · Tempo di carica · Timp de încarcare · Latausaika · Czas ładowania



### Leuchtdauer · Luminous period

Durée d'éclairage · Brandtijd · Tiempo de iluminación · Tempo di durata · Perioada de iluminare · Valaistusaika · Czas świecenia



### Flammen-Effekt · Flame effect

Effet de flamme · Vlammeneffect · Efecto de llamas · Effetto fiamma · Efect de flacăra · Liekkitehoste · Efekt płomienia



### Abstrahlwinkel · Emission angle

Angle de rayonnement · Uitstraalhoek · Ángulo de emisión · Angolo di emissione · Unghiul de emisii · Säteilukulma · Kąt emisji



### Belastbarkeit · Resilience

Limite de charge · Belastbaarheid · Resistencia · Resistenza · Reziștența la solicitare · Kuormittavuus · Nośność



### Inkl. Verbinder für Reihenschaltung ·

#### Connector for series connection included

Connecteur pour connexion en série inclus · Connector voor serieaansluiting inbegrepen · Conector para conexión en serie incluido · Connettore per il collegamento in serie incluso · Conector pentru conectarea în serie inclus · Mukana liitin sarjakytkentää varten · W zestawie złącze do połączenia szeregowego



### Bewegungssensor und Orientierungslicht.

Die Leuchte verfügt über ein Orientierungslicht, das sich bei Dämmerung oder Dunkelheit automatisch einschaltet. Wird eine Bewegung erfasst, schaltet die Leuchte von Orientierungslicht auf volle Lichtleistung

#### Motion sensor and orientation light .

The luminaire has an orientation light that switches on automatically at dusk or in the dark. If movement is detected, the luminaire switches from orientation light to full light output.

#### Captur de mouvement et lumière d'orientation.

Le luminaire est muni d'une lumière d'orientation qui s'allume automatiquement dès qu'il fait sombre ou dans le noir. Si un mouvement est détecté, le luminaire passe de la lumière d'orientation à la lumière maximale.

#### Bewegingssensor en oriëntatielicht.

Het verlichtingstoestel heeft een oriëntatielicht dat automatisch inschakelt bij schemerdonker of in het donker. Wanneer beweging waargenomen wordt, schakelt het verlichtingstoestel over van oriëntatielicht naar volledig lichtvermogen.

#### Lámpara con sensor de movimiento y de orientación.

La lámpara dispone de una luz de orientación que se enciende automáticamente al anochecer o en la oscuridad. Si se detecta movimiento, la lámpara pasa de luz de orientación a plena potencia luminosa.

#### Sensore di movimento e luce di orientamento.

La lampada è dotata di una luce di orientamento che si accende automaticamente al crepuscolo o al buio. Se viene rilevato un movimento, la lampada passa dalla luce di orientamento alla piena emissione di luce.

#### Senzor de mișcare și lumină de orientare.

Corpul de iluminat are o lumină de orientare care se pornește automat în amurg sau în întuneric. Dacă este detectată mișcare, corpul de iluminat trece de la lumina de orientare la iluminat deplin.

#### Liiketunnistin ja suuntavallo.

Valaisimessa on suuntavallo, joka syttyy automaattisesti illansarastuksessa tai pimeään laskiessa. Jos liikettä havaitaan, valaisin siirtyy suuntavalosta täyteen valaistustehoon.

#### Czujnik ruchu i światło orientacyjne.

Oprawa posiada światło orientacyjne, które włącza się automatycznie o zmierzchu lub w ciemności. W przypadku wykrycia ruchu oprawa przełącza się ze światła orientacyjnego na pełną moc świetlną.



### USB-C Anschluss mit Ladefunktion ·

#### Recharging USB\_c connection

Entrée USB-C de rechargement · Opladende USB-C aansluiting · Conexión USB-C de recarga · Connessione USB-C di ricarica · Conexiune USB-C reîncărcare · Lataaminen USB-C-liitäntä · ładowania USB-C połączenie



### Indirekte Beleuchtung · Indirect lighting

Lumière indirecte · Indirecte belichting · Iluminación indirecta · Illuminazione a scomparsa · Iluminat indirect · Epäsuoja valaistus · Oświetlenie pośrednie



### USB-C Anschluss · USB-C connection

Entrée USB-C · USB-C-aansluiting · Conexión USB-C · Connessione USB-C · Conexiune USB-C · USB-C-liitäntä · Połączenie USB-C



### Inklusive Ladestation ·

#### Charging station included

Station de recharge incluse · Laadstation inbegrepen · Estación de carga incluida · Stazione di ricarica inclusa · Stație de încărcare inclusă · Latausasema sisältyy · W zestawie stacja ładowająca



### Solar · Solar

Solaire · Solair · Solar · Solare · Solar · Aurinkokenno · Solar

# Farben & Materialien · Colours and materials

Couleurs et matériaux · Kleuren en materialen · Colores y materiales · Colori e materiali ·  
Culori si materiale · Värit ja materiaalit · Kolory i materiały

## 01 Weiß · white

blanc · wit · blanco · bianco · alb · valkoinen · biały

## 02 Schwarz · black

noir · zwart · negro · nero · negru · musta · czarny

## 07 Nickel matt · nickel mat

nickel mat · nikkel mat · níquel mate · nichel opaco ·  
nichel mat · harjattu teräs · nikiel mat

## 10 Rot · red

rouge · rood · rojo · rosso · rosu ·  
punainen · czerwony

## 11 Grau · grey

gris · grijs · gris · grigio · gri · harmaa · popielaty

## 24 rostfarbig · rusty

rouille · roestkleur · óxido · ruggine · ruginiu ·  
rustiikki · miedź

## 28 rostfarbig antik · antique rust

rouille antique · roestkleur antiek · oxido ·  
ruggine anticato · ruginiu antic · rustiikki ·  
antyczny rdzawy

## 35 Holznachbildung · wood imitation

imitation bois · houtimitatie · imitación de madera ·  
effetto legno · imitație de lemn · puujäljitelmä ·  
imitacja drewna

## 31 Weiß matt · white mat

blanc mat · wit mat · estera blanca · bianco opaco ·  
alb mat · valkoinen matto · biały mat

## 32 Schwarz matt · black mat

noir mat · mat zwart · estera negra · nero opaco ·  
negru mat · musta matto · czarny mat

## 42 Anthrazit · anthracite

antracite · antraciet · antracita · antracite · antracit ·  
antrasiitti · antracyt

## 49 Pistaziengrün · pistachio green

vert pistache · pistachegroen · verde pistacho ·  
verde pistacchio · verde fistic · pistaasin vihreä ·  
zielony pistacjowy

## 54 rauchfarbig · smoke

fumé · rookkleur · humo · fume' · fumuriu ·  
savu · przydymiony · duman

## 66 Sand · sable

zand · arena · sabbia · nisip · hiekka · piaskowy ·  
kum

## 77 Ultimate Grau · ultimate grey

gris ultimate · ultiem grijs · gris absoluto ·  
grigio assoluto · gri suprem · ultimaattinen harmaa ·  
ciemnoszary

## 83 Illuminate Gelb · illuminate yellow

jaune illuminate · helder geel · amarillo iluminado ·  
giallo brillante · galben strălucitor · hehkuvan keltainen ·  
swietlisty żółty

Seite Page	Artikel-Nr. Product No.	EAN-Nummer EAN-Number	Seite Page	Artikel-Nr. Product No.	EAN-Nummer EAN-Number
109	201760124	4017807442021	22	220760142	4017807259063
109	201760142	4017807445411	43	220969142	4017807259315
82	201860142	4017807433210	30	221160142	4017807302004
82	201860242	4017807442410	28	221169142	4017807279290
83	201869142	4017807603378	67	221460142	4017807490473
110	201960124	4017807442045	67	221460242	4017807564037
110	201960142	4017807442052	98	221560142	4017807282375
111	202360124	4017807449891	34	221660242	4017807291544
111	202360142	4017807442069	34	221669242	4017807297614
112	202760124	4017807445589	24	221760142	4017807303551
112	202760142	4017807449884	25	221769142	4017807303568
104	204160124	4017807413939	94	222260124	4017807410594
102	204160131	4017807492408	86	222260132	4017807603620
102	204160142	4017807413946	90	222260142	4017807382570
105	204169124	4017807492446	94	222260224	4017807410587
105	204169131	4017807492422	86	222260232	4017807603637
105	204169142	4017807492460	90	222260242	4017807382587
76	204260224	4017807519006	73	222960242	4017807491326
76	204260231	4017807518986	73	222969242	4017807491371
76	204260242	4017807453171	88	224060132	4017807603583
77	204269224	4017807519044	92	224060142	4017807434330
77	204269231	4017807519020	88	224060232	4017807603590
76	204269242	4017807453195	92	224060242	4017807434347
116	205760132	4017807543407	32	225360142	4017807481501
116	205767132	4017807543414	33	225369142	4017807481525
114	205960128	4017807543575	18	226260142	4017807492545
114	205967128	4017807543582	40	226360142	4017807492347
71	206060142	4017807490480	40	226369142	4017807492354
118	206960132	4017807543810	57	226460231	4017807415605
118	206967132	4017807543803	57	226460242	4017807415612
108	207269124	4017807492613	58	226560242	4017807408539
108	207269142	4017807492637	42	226660242	4017807388893
84	207360142	4017807492675	42	226669242	4017807388817
113	210860142	4017807506129	61	226860242	4017807382839
113	210869142	4017807506143	54	226960231	4017807382259
100	211060142	4017807506174	54	226960242	4017807382266
100	211069142	4017807506198	48	227260142	4017807369236
80	211660132	4017807564075	51	227360142	4017807369229
78	211660135	4017807603439	56	227560231	4017807337570
106	212060142	4017807529272	56	227560242	4017807337594
106	212069142	4017807529289	56	227660231	4017807337600
46	212160242	4017807529340	56	227660242	4017807337617
70	212560224	4017807564051	49	227760142	4017807303537
70	212560231	4017807564068	50	228060142	4017807281569
70	212560232	4017807564044	44	228260142	4017807279535
74	214260142	4017807529210	59	228460242	4017807284164
74	214260242	4017807529234	45	228560242	4017807356984
74	214269142	4017807529227	47	228669142	4017807356656
74	214269242	4017807529241	52	228960142	4017807259131
55	218560235	4017807603477	72	229160142	4017807242126
55	218560242	4017807603460	60	229360242	4017807242164
96	220060142	4017807241501	66	240660142	4017807563979
96	220060242	4017807241525	68	240760142	4017807563986

Seite Page	Artikel-Nr. Product No.	EAN-Nummer EAN-Number	Seite Page	Artikel-Nr. Product No.	EAN-Nummer EAN-Number
14	240960142	4017807563993	90	422260142	4017807382600
14	240969142	4017807564006	88	424060132	4017807603613
62	245560131	4017807603415	92	424060142	4017807434361
62	245560142	4017807603392	93	424067142	4017807445404
62	245569131	4017807603422	32	425360142	4017807481563
62	245569142	4017807603408	18	426260142	4017807492576
36	246360142	4017807603484	14	440969142	4017807564020
36	246360242	4017807603491	20	446960135	4017807603736
36	246360342	4017807603507	12	447060142	4017807603750
69	246660342	4017807603514	26	470660142	4017807529197
64	246760231	4017807603521	16	477860142	4017807564112
64	246760232	4017807603538	82	501860142	4017807433234
64	246760431	4017807603545	104	504160124	4017807413977
64	246760432	4017807603552	102	504160142	4017807413991
41	246860142	4017807603569	76	504260142	4017807453218
41	246869142	4017807603576	116	505760132	4017807543421
20	246960135	4017807603705	114	505960128	4017807543599
20	246969135	4017807603712	71	506060142	4017807490497
12	247060142	4017807603767	118	506960132	4017807543827
12	247069142	4017807603774	84	507360142	4017807492705
38	247360142	4017807603781	80	511660132	4017807564082
38	247360242	4017807603798	78	511660135	4017807603446
26	270660142	4017807529111	74	514260142	4017807529258
26	270660242	4017807529159	96	520060142	4017807241563
27	270669142	4017807529135	22	520760142	4017807259100
27	270669242	4017807529166	30	521160142	4017807351590
16	277860142	4017807529333	28	521169142	4017807279313
82	401860142	4017807433258	34	521660242	4017807291568
83	401869142	4017807603385	24	521760142	4017807303575
104	404160124	4017807413953	94	522260124	4017807410563
102	404160142	4017807413960	86	522260132	4017807603644
76	404260142	4017807453232	90	522260142	4017807382594
116	405760132	4017807543445	88	524060132	4017807603606
116	405760332	4017807543452	92	524060142	4017807434354
114	405960128	4017807543605	32	525360142	4017807481549
114	405960328	4017807543612	18	526260142	4017807492569
118	406960132	4017807543834	14	540969142	4017807564013
118	406960332	4017807543841	20	546960135	4017807603729
84	407360142	4017807492729	12	547060142	4017807603743
100	411060142	4017807506211	26	570660142	4017807529173
100	411060342	4017807506228	16	577860142	4017807564105
80	411660132	4017807564099	82	601860242	4017807442397
78	411660135	4017807603453	53	676960131	4017807453393
74	414260142	4017807529265	53	676960142	4017807453416
96	420060142	4017807241792	16	677860142	4017807529326
22	420760142	4017807259087	120	800260142	4017807453133
30	421160142	4017807351583	120	800260342	4017807453157
28	421169142	4017807279306	122	821660107	4017807453287
98	421560242	4017807282405	122	821660207	4017807453348
34	421660242	4017807291551	121	821860142	4017807564143
24	421760142	4017807303582	124	9960-07	4017807259360
94	422260124	4017807410570	123	9962-11	4017807305784
86	422260132	4017807603651	123	9964-42	4017807445299



Seite Page	Artikel-Nr. Product No.	EAN-Nummer EAN-Number	Seite Page	Artikel-Nr. Product No.	EAN-Nummer EAN-Number
125	9965-32	4017807472349	180	R54076101	4017807564273
140	R21186131	4017807564136	158	R54086131	4017807564280
140	R21186132	4017807564129	158	R54086132	4017807564297
132	R21596124	4017807603828	154	R54096131	4017807564327
132	R21596131	4017807603804	154	R54096132	4017807564334
132	R21596132	4017807603811	154	R54096177	4017807564341
132	R21599124	4017807603859	154	R54096631	4017807601671
132	R21599131	4017807603835	154	R54096632	4017807601688
132	R21599132	4017807603842	154	R54096677	4017807601695
130	R21716142	4017807603866	152	R54106110	4017807601817
128	R21719142	4017807603873	152	R54106131	4017807601787
136	R22052142	4017807490428	152	R54106132	4017807601794
136	R22062142	4017807490435	152	R54106149	4017807601800
145	R22151142	4017807453546	152	R54106166	4017807606195
179	R22231107	4017807458220	152	R54106177	4017807601824
179	R22231142	4017807452648	160	R54126131	4017807570571
178	R22241142	4017807452662	160	R54126142	4017807570595
174	R22251142	4017807452686	167	R55086101	4017807444421
176	R22261142	4017807452723	164	R55101101	4017807500271
178	R22281142	4017807452754	182	R55256111	4017807492064
142	R24236142	4017807564150	182	R55256911	4017807492095
143	R24246132	4017807564167	186	R55326101	4017807492101
137	R24256232	4017807564174	186	R55326901	4017807492125
137	R24266232	4017807564181	184	R55346132	4017807529425
138	R27026132	4017807529357	170	R57042001	4017807282801
138	R27036132	4017807529364	168	R57042054	4017807603668
141	R27446132	4017807603699	170	R57043001	4017807282818
134	R28222631	4017807408324	168	R57043054	4017807603675
134	R28222632	4017807411775	170	R57044001	4017807282825
135	R28232631	4017807408317	168	R57044054	4017807603682
135	R28232632	4017807411768	162	R57051101	4017807382518
185	R35146132	4017807529432	163	R57071101	4017807325348
130	R41716142	4017807603903	166	R57080101	4017807407556
128	R41719142	4017807603910	148	R57706110	4017807601732
174	R42251142	4017807452709	148	R57706131	4017807601701
176	R42261142	4017807452730	148	R57706132	4017807601718
164	R45101101	4017807500295	148	R57706149	4017807601725
164	R45101901	4017807500301	150	R57716110	4017807603361
148	R47706110	4017807601770	150	R57716131	4017807603330
148	R47706131	4017807601749	150	R57716142	4017807603347
148	R47706132	4017807601756	150	R57716149	4017807603354
148	R47706149	4017807601763	150	R57716166	4017807606201
130	R51716142	4017807603880	159	R57726131	4017807601831
128	R51719142	4017807603897	159	R57726132	4017807601848
157	R52176101	4017807496314	159	R57726177	4017807603989
157	R52176102	4017807496338	144	R60501031	4017807405873
157	R52176149	4017807541236	144	R60501042	4017807405910
157	R52176177	4017807541274	144	R60502031	4017807405927
157	R52176183	4017807541229	144	R60502042	4017807405934
156	R52306131	4017807540925	145	R62151142	4017807405989
156	R52306132	4017807540901			
156	R52306149	4017807541014			
181	R54066101	4017807564266			



### **TRIO Leuchten GmbH**

Gut Nierhof 17  
D-59757 Arnsberg  
T +49 (0) 2931 9666-0  
F +49 (0) 2931 9666-57  
info@trio-leuchten.de  
www.trio-leuchten.de

### **Reality Leuchten GmbH**

Gut Nierhof 17  
D-59757 Arnsberg  
T +49 (0) 2931 9666-99  
F +49 (0) 2931 9666-98  
info@reality-leuchten.de  
www.reality-leuchten.de

### **BADEN WÜRTTEMBERG, RHEINLAND-PFALZ UND SAARLAND**

**Antonio De Simone**  
T +49 (0) 151 5855222  
antonio.desimone@trio-leuchten.de

### **ÖSTERREICH**

**Wolfgang Melich**  
T +43 (0) 6605161228  
wolfgang.melich@trio-leuchten.de

### **BAYERN, HESSEN**

**Martin Kluge**  
T +49 (0) 171 7300330  
martin.kluge@trio-leuchten.de

### **SCHWEIZ**

**TRIO Leuchten**  
T +49 (0) 2931 9666-0  
info@trio-leuchten.de

### **BERLIN, BRANDENBURG, MECKLENBURG-VORPOMMERN, SACHSEN, SACHSEN ANHALT, THÜRINGEN**

**Jörg Bumke**  
T +49 (0) 160 7406860  
joerg.bumke@trio-leuchten.de

### **BREMEN, HAMBURG, NIEDERSACHSEN, SCHLESWIG-HOLSTEIN**

**Jens Gebers**  
T +49 (0) 170 1615227  
jens.gebers@trio-leuchten.de

### **NORDRHEIN-WESTFALEN**

**Christian Teller**  
T +49 (0) 171 4521820  
christian.teller@trio-leuchten.de

## TRIO International GmbH

Gut Nierhof 17  
D-59757 Arnsberg  
T +49 (0) 2931 9666-587  
F +49 (0) 2931 9666-56  
info@trio-lighting.com  
www.trio-lighting.com

## FRANCE

### Stéphane Papierny

Directeur Commercial France  
info.france@trio-lighting.com

### Julien Lamouret

Product Manager France &  
Sales Manager DIY France  
info.france@trio-lighting.com

### Jean Philippe Bailly

info.france@trio-lighting.com  
Agent exclusif pour les départements  
60, 75 Nord, 92, 93 et 95

### Jean Barel / Bruno Rouquié

info.france@trio-lighting.com  
Agent exclusif pour les départements  
09, 12, 15, 16, 19, 24, 31, 32, 33, 40, 46,  
47, 64, 65, 81, 82 et 87

### Jean Marc Beneforti

info.france@trio-lighting.com  
Agent exclusif pour les départements  
2a et 2b

### Christophe Meulien

info.france@trio-lighting.com  
Agent exclusif pour les départements  
04, 05, 06, 11, 13, 30, 34, 66, 83 et 84

### Sullivan Nicolas

info.france@trio-lighting.com  
Agent exclusif pour les départements  
04, 05, 06, 21, 23, 26, 38, 39, 42, 43, 48,  
63, 69, 71, 73 et 74

### Stéphane Riebel

info.france@trio-lighting.com  
Agent exclusif pour les départements  
18, 27, 28, 45, 58, 75 Sud, 76, 77,  
78, 89, 91 et 94

### Michel Salamand

info.france@trio-lighting.com  
Agent exclusif pour les départements  
14, 17, 22, 29, 35, 36, 37, 41, 44, 49, 50,  
53, 56, 61, 72, 79, 85 et 86

### Vincent Zaepffel

info.france@trio-lighting.com  
Commercial pour les départements  
02, 08, 10, 25, 51, 52, 54, 55, 57, 59, 62,  
67, 68, 70, 80, 88 et 90

## DANMARK

### Jan Rantzau-Bartens

info.denmark@trio-lighting.com

## NORDIC & BALTIC

### TRIO Lighting Scandinavia Oy

Malmin raitti, rappu 17 B  
00700 Helsinki  
T +358 (0) 10 23 13 390  
tls@trio-lighting.com

*Our Scandinavian organisation represents TRIO  
also in Sweden, Norway, Estonia, Latvia, Lithuania  
and Iceland*

## ITALIA

### TRIO Lighting Italia s.r.l

Via Isonzo 81  
22066 Mariano Comense (CO)  
cormmerciale@trio-lighting.com

## ESPAÑA

### TRIO Lighting Ibèrica SL

C/ Can Lietget n°9 nave 9  
Pol. Ind. Can Roqueta  
08206 Sabadell  
T +34 (0) 9 35 45 86 30  
F +34 (0) 9 33 96 45 48  
info.iberica@trio-lighting.com

## GREAT BRITAIN

### TRIO Lighting UK Ltd.

Unit 5, Hemmells Park Hemmells,  
Laindon Essex  
SS1s 6GF  
T +44 (0) 12 68 88 95 95  
F +44 (0) 12 68 88 95 96  
sales@trio-lightinguk.com

## NEDERLAND

### Karl Stok / Bas Martin

info.nederland@trio-lighting.com

## BELGIUM

### Yves Van den Berghe

info.belgium@trio-lighting.com

## ROMANIA

### Loredana Barbu

info.romania@trio-lighting.com  
loredana.barbu@trio-lighting.com

# OUTDOOR

## **TRIO Leuchten GmbH**

Gut Nierhof 17  
D-59757 Arnsberg  
T +49 2931 9666-0  
F +49 2931 9666-28  
info@trio-leuchten.de  
www.trio-leuchten.de

## **Reality Leuchten GmbH**

Gut Nierhof 17  
D-59757 Arnsberg  
T +49 2931 9666-99  
F +49 2931 9666-98  
info@reality-leuchten.de  
www.reality-leuchten.de

## **TRIO International GmbH**

Gut Nierhof 17  
D-59757 Arnsberg  
T +49 2931 9666-587  
F +49 2931 9666-56  
info@trio-lighting.com  
www.trio-lighting.com

 /trioleuchten

 @trio.lighting

 @trioleuchten

 @TRIO Lighting Group

 @triolighting

