

TOPMET®

**2023**

LED profiles  
Profile LED  
LED-Profile  
Profilés à LED

# ACCESSORIES FOR LED SYSTEM - DIFFUSERS

## SYSTEMOWE AKCESORIA LED - KLOSZE

### ZUBEHÖR FÜR LED-SYSTEME - ABDECKUNGEN

#### ACCESSOIRES POUR SYSTEMES LED - DIFFUSEURS

**A**  
slide  
wsuwany  
einschiebbar  
coulissant

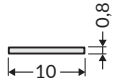

→ 194

**A1** **NEW**  
slide  
wsuwany  
einschiebbar  
coulissant

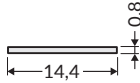

→ 194

**A9**  
slide  
wsuwany  
einschiebbar  
coulissant

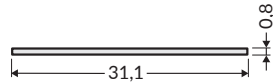

→ 194

**B**  
slide  
wsuwany  
einschiebbar  
coulissant

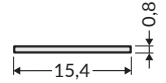

→ 194

**C** **NEW BLACK** **NEW 20 m**  
click  
klik  
einclipbar  
clac

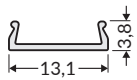

→ 195

**C**<sup>1</sup>  
click lens gen2  
klik soczewka gen2  
einclipbar Linse gen2  
clac lentille gen2

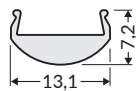

→ 195

**C1**  
click  
klik  
einclipbar  
clac

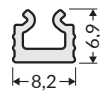

→ 195

**C2** **NEW BLACK** **NEW 20 m**  
click  
klik  
einclipbar  
clac

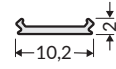

→ 196

**C3** **NEW BLACK**  
click  
klik  
einclipbar  
clac

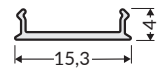

→ 196

**C4**  
click  
klik  
einclipbar  
clac

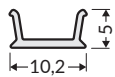

→ 196

**C9** **NEW BLACK**  
click  
klik  
einclipbar  
clac

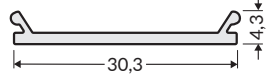

→ 197

click  
klik  
einclipbar  
clac

**C10**<sup>1</sup> **OPAL**

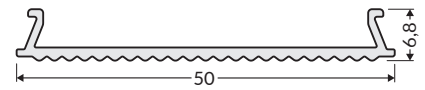

**C10**<sup>2</sup> **NARROW**

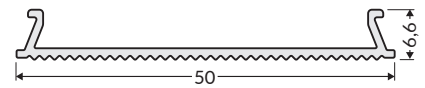

**C10**<sup>3</sup> **WIDE**

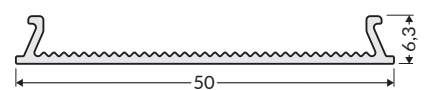

→ 197

**D**  
click  
klik  
einclipbar  
clac

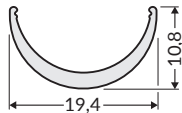

→ 198

**D9**  
click  
klik  
einclipbar  
clac

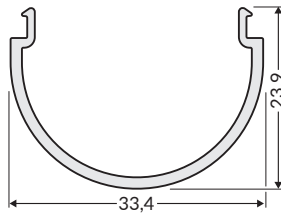

→ 198

**E**  
slide  
wsuwany  
einschiebbar  
coulissant

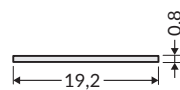

→ 198

**E7**  
click  
klik  
einclipbar  
clac

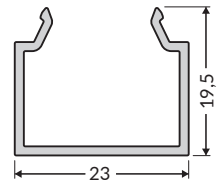

→ 198

**E9**  
click  
klik  
einclipbar  
clac

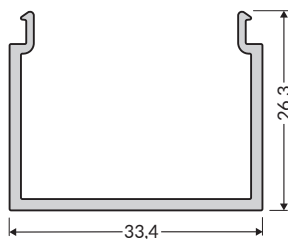

→ 199

**F** **NEW BLACK** **NEW 20 m**  
click  
klik  
einclipbar  
clac

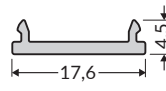

→ 199

**G**  
slide  
wsuwany  
einschiebbar  
coulissant

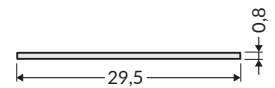

→ 199

**H**  
slide  
wsuwany  
einschiebbar  
coulissant

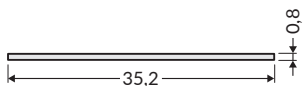

→ 200

**I**  
click  
klik  
einclipbar  
clac

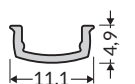

→ 200

**J**  
slide  
wsuwany  
einschiebbar  
coulissant

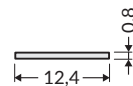

→ 200

**K**  
click  
klik  
einclipbar  
clac

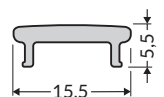

→ 200





**TOPMET<sup>®</sup>**

**2023**

LED profiles  
Profile LED  
LED-Profile  
Profils à LED

TUTORIAL  
KROK PO KROKU  
SCHRITT FÜR SCHRITT  
ÉTAPE PAR ÉTAPE  
→ 6

SURFACE  
NAWIERZCHNIOWE  
AUFBAUPROFILE  
SURFACE  
→ 31

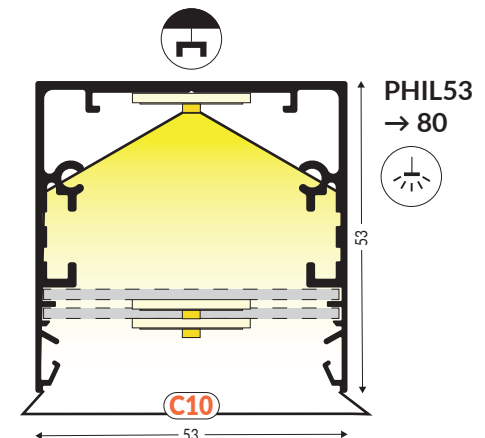
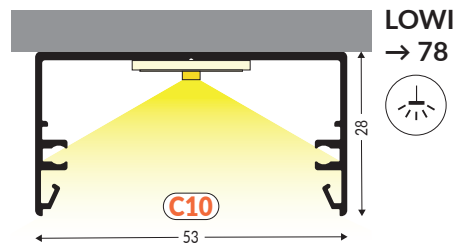
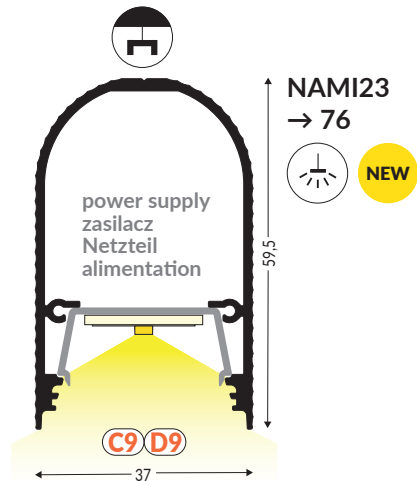
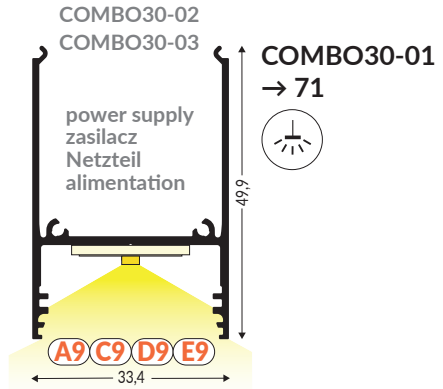
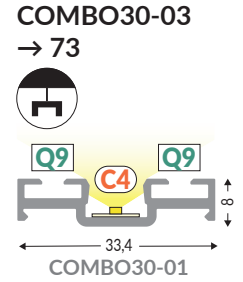
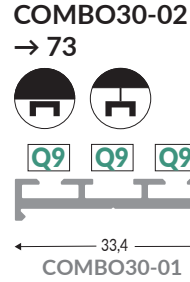
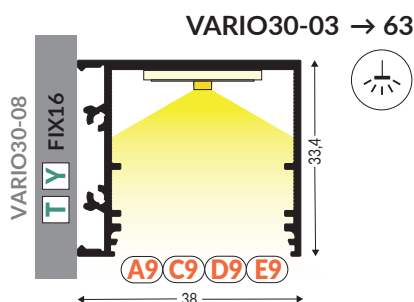
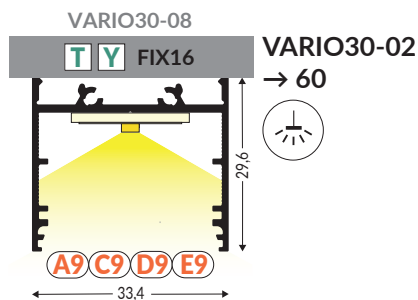
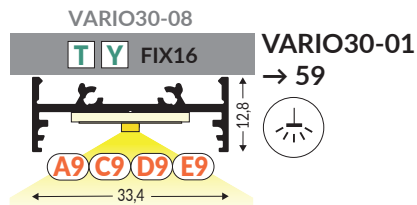
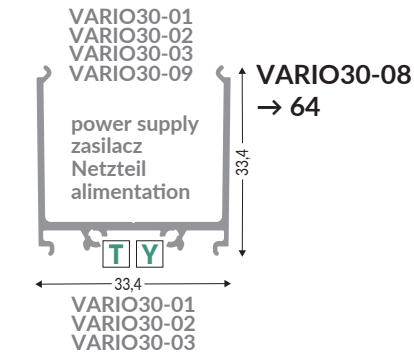
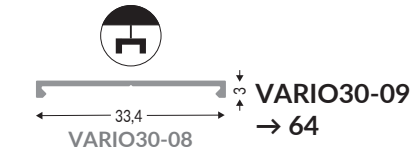
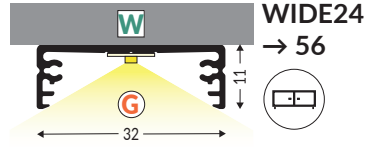
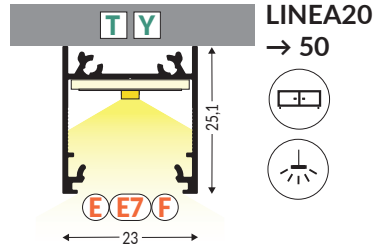
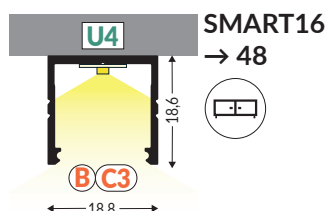
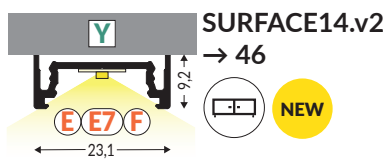
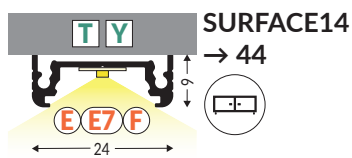
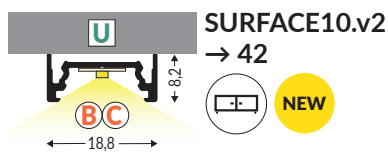
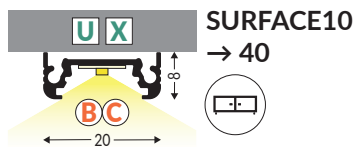
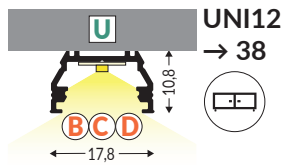
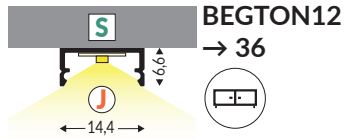
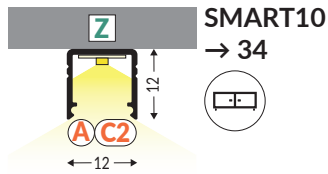
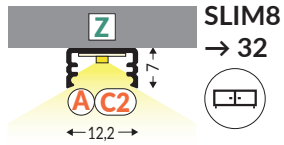

RECESSED  
WPUSTOWE  
EINBAUPROFILE  
A ENCASTRER  
→ 83

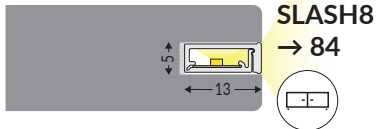

SLASH8  
→ 84

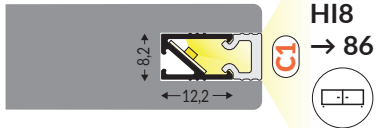

HI8  
→ 86

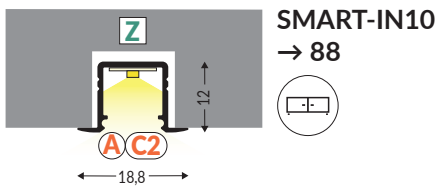

SMART-IN10  
→ 88

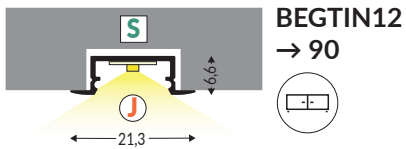

BEGTIN12  
→ 90

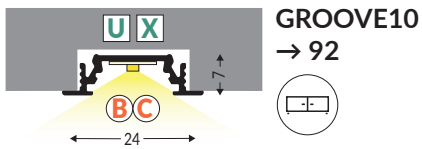

GROOVE10  
→ 92

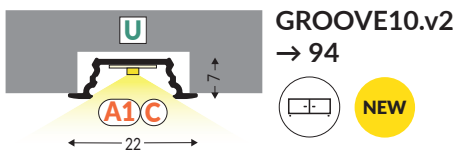

GROOVE10.v2  
→ 94

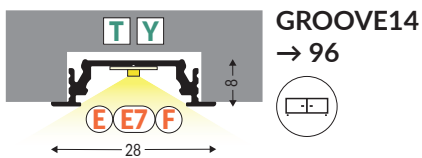

GROOVE14  
→ 96

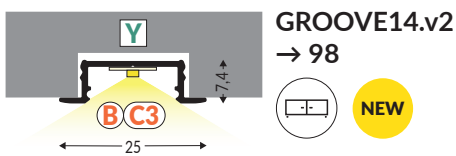

GROOVE14.v2  
→ 98

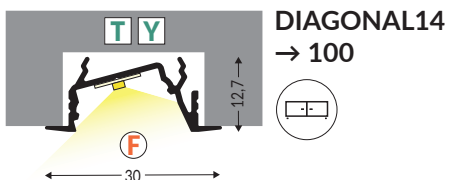

DIAGONAL14  
→ 100

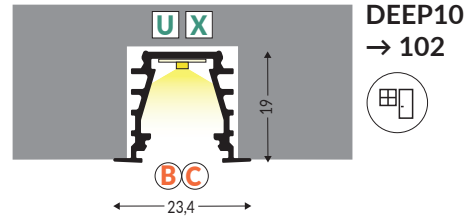

DEEP10  
→ 102

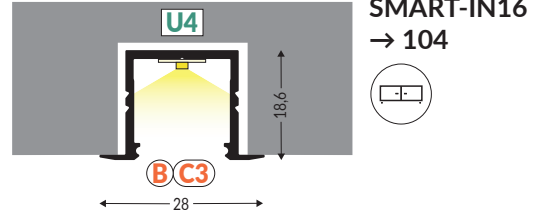

SMART-IN16  
→ 104

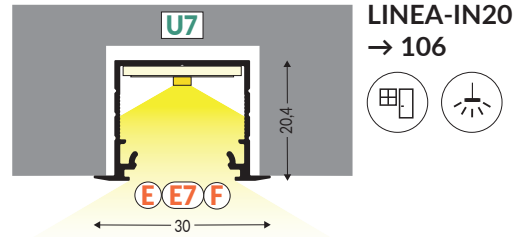

LINEA-IN20  
→ 106

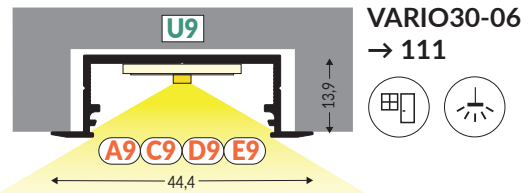

VARIO30-06  
→ 111

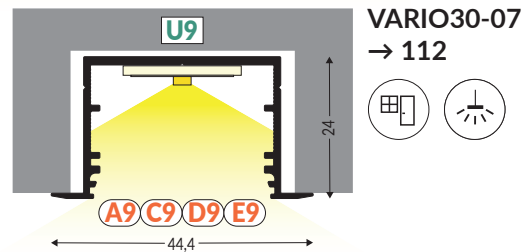

VARIO30-07  
→ 112

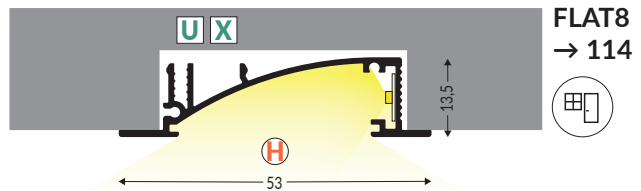

FLAT8  
→ 114

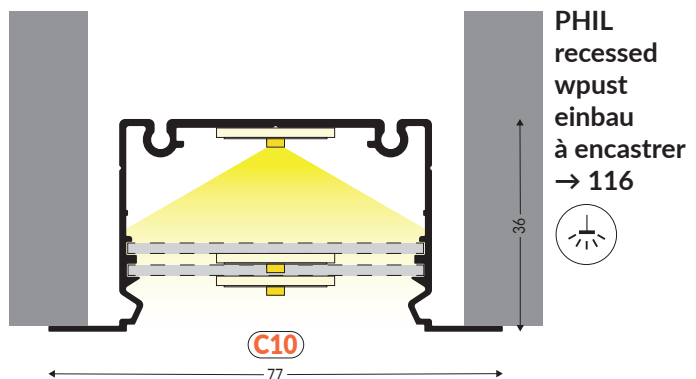

PHIL  
recessed  
wput  
einbau  
à encastrer  
→ 116

**CORNER  
KĄTOWE  
ECKPROFILE  
D'ANGLES**  
→ 119

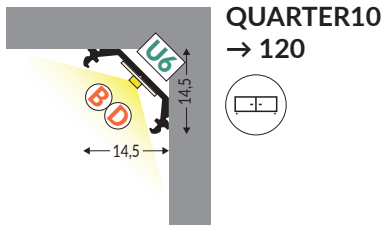

**QUARTER10**  
→ 120

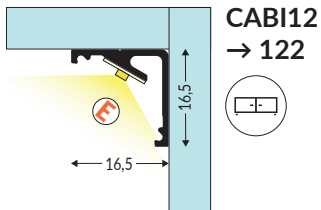

**CABI12**  
→ 122

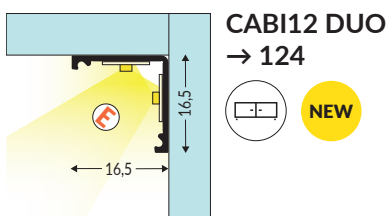

**CABI12 DUO**  
→ 124

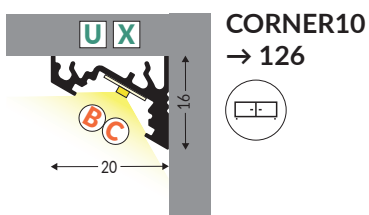

**CORNER10**  
→ 126

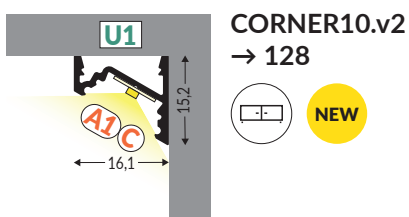

**CORNER10.v2**  
→ 128

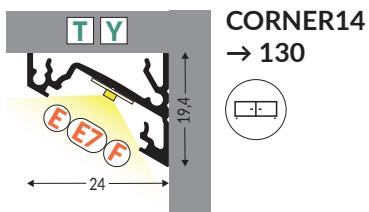

**CORNER14**  
→ 130

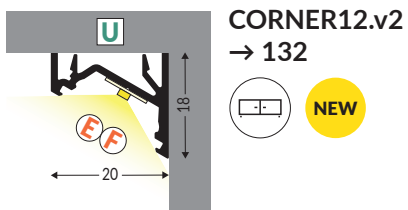

**CORNER12.v2**  
→ 132

**PLASTER-IN  
DO SZPACHLOWANIA  
ZUM SPACHTELN  
POUR LE REMPLISSAGE**  
→ 135

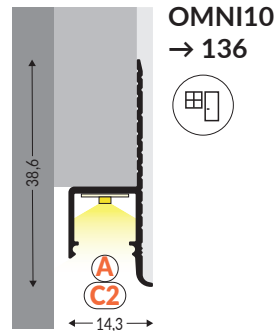

**OMNI10**  
→ 136

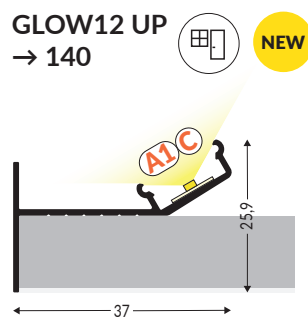

**GLOW12 UP**  
→ 140

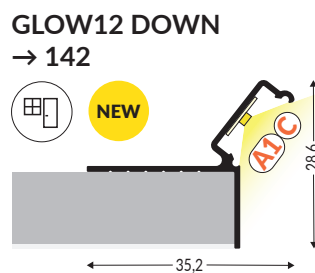

**GLOW12 DOWN**  
→ 142

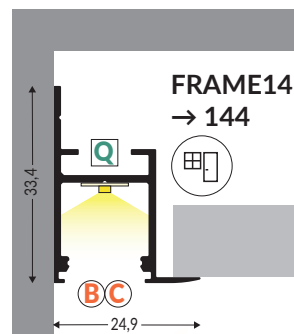

**FRAME14**  
→ 144

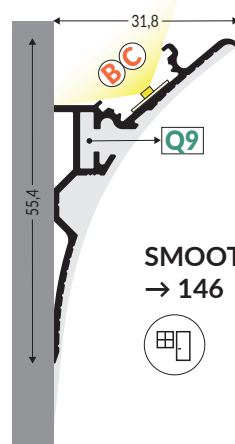

**SMOOTH12**  
→ 146

**HIDE10**  
→ 148

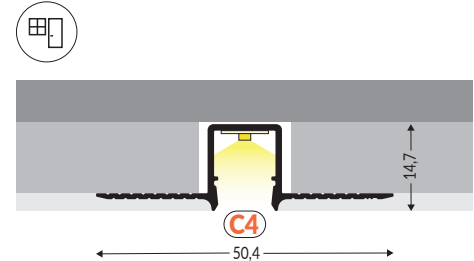

**LINEA-IN20 TRIMLESS**  
→ 150

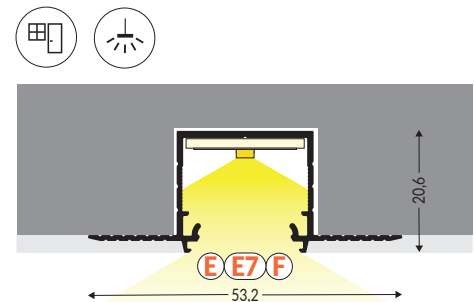

**VARIO30-04**  
→ 153

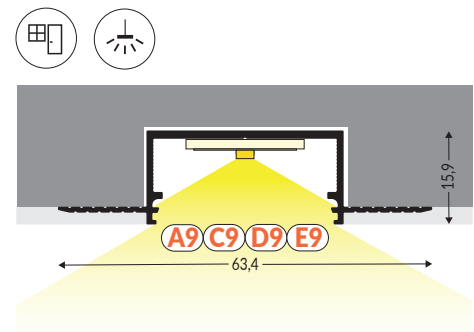

**VARIO30-05**  
→ 154

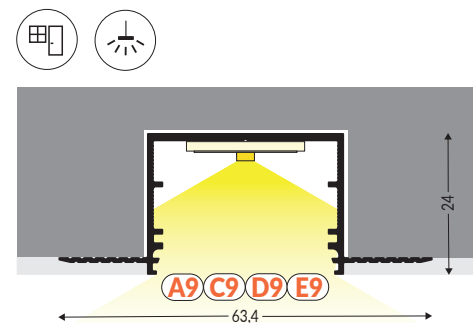

**TILE-IN  
DO PŁYTEK  
FÜR FLIESEN  
POUR LES CARREAUX**  
→ 157

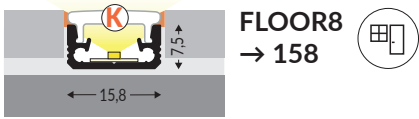

**FLOOR8**  
→ 158

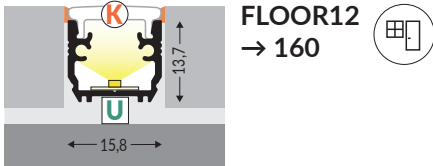

**FLOOR12**  
→ 160

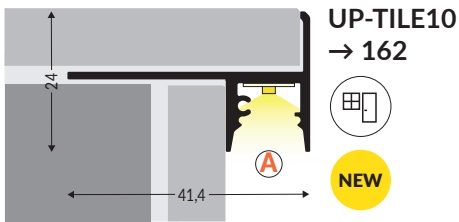

**UP-TILE10**  
→ 162

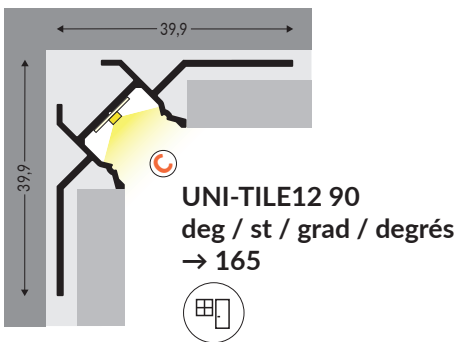

**UNI-TILE12 90**  
deg / st / grad / degrés  
→ 165

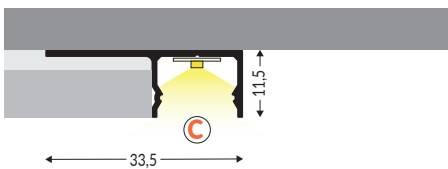

**UNI-TILE12 180**  
deg / st / grad / degrés  
→ 166

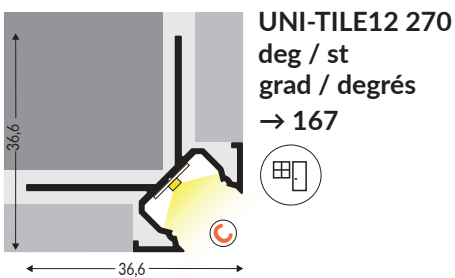

**UNI-TILE12 270**  
deg / st / grad / degrés  
→ 167

**SPECIAL APPLICATION  
SPECJALNY  
SPEZIELLE PROFILE  
SPÉCIAL**  
→ 169

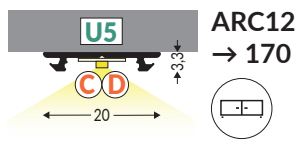

**ARC12**  
→ 170

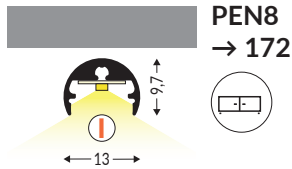

**PEN8**  
→ 172

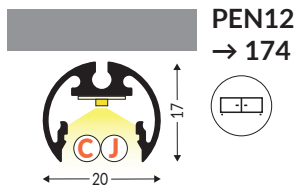

**PEN12**  
→ 174

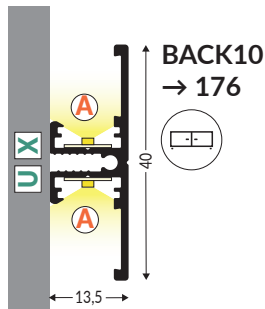

**BACK10**  
→ 176

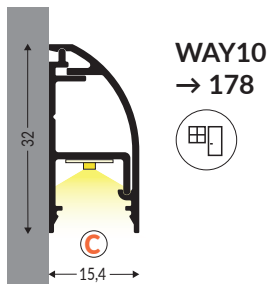

**WAY10**  
→ 178

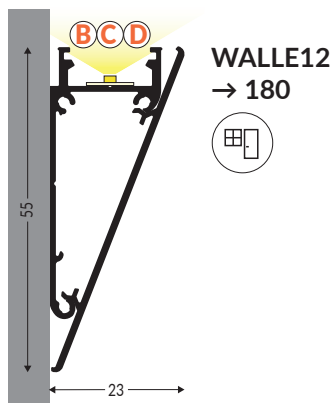

**WALLE12**  
→ 180

**UP-MINI10**  
→ 182

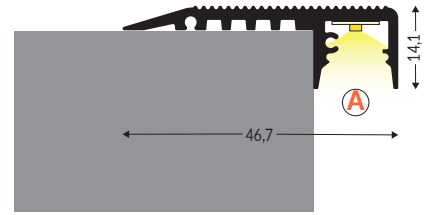

**UP-BOLD12**  
→ 184

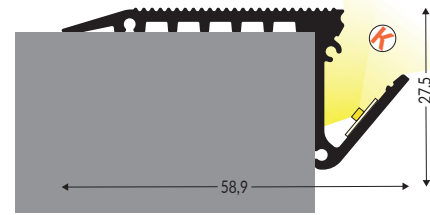

**SKIRT10**  
→ 186

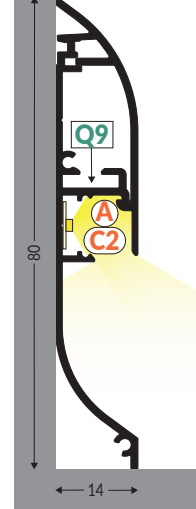

**BASE**  
→ 188

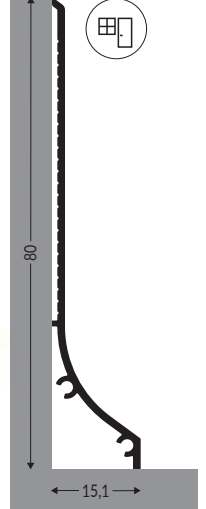

**FIX12**  
→ 191

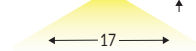

**FIX16**  
→ 191

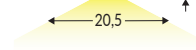

**ACCESSORIES  
AKCESORIA  
ZUBEHÖR  
ACCESSOIRES**  
→ 193

# Designing, manufacturing, illuminating since 1989

## Projektujemy, produkujemy, oświetlamy od 1989

### Wir entwerfen, herstellen, beleuchten seit 1989

#### Conception fabrication d'éclairage depuis 1989

TOPMET Light has been operating in the lighting industry for more than 30 years. We create products adapted to the changing technologies and follow micro and macro trends. We never cease to look for new possibilities and inspire.

Firma TOPMET Light działa w branży oświetleniowej od ponad 30 lat. Tworzymy produkty uwzględniające zmieniające się technologie, śledzimy trendy mikro i makro. Nieustannie poszukujemy nowych możliwości i inspirujemy.

Das Unternehmen TOPMET Light ist in der Beleuchtungsbranche seit über 30 Jahren tätig. Wir entwickeln Produkte, die neue Technologien berücksichtigen und beobachten die Mikro- und Makrotrends. Ständig suchen wir nach neuen Möglichkeiten und sind eine Inspiration.

TOPMET est présent dans le secteur d'éclairage depuis près de 30 ans. Nous créons des produits adaptés aux technologies qui se transforment et suivons les micro- et macro-tendances. Nous ne cessons pas de chercher de nouvelles possibilités et d'inspirer.



In the recent years, our offer has been dominated by the idea of creating various effects with the use of the LED profiles range and compatible accessories. We follow trends and offer innovative solutions that help create reality.

I tak przez ostatnie lata dominuje w naszej ofercie idea tworzenia różnorodnych efektów z wachlarza profili LED oraz kompatybilnych akcesoriów. Obserwujemy trendy i proponujemy innowacyjne rozwiązania, które pomagają kreować rzeczywistość.

In den letzten Jahren wurde unser Angebot von einem Konzept beherrscht, verschiedene Effekte aus der Palette der LED-Profile und kompatibler Ausrüstung zu erzeugen. Wir beobachten die Trends und schlagen innovative Lösungen vor, mit denen die Realität mitgestaltet wird.

Depuis quelques années, notre offre est dominée par l'idée de créer une variété d'effets à partir de la gamme de profils LED et des accessoires compatibles. Nous suivons les tendances et proposons des solutions innovantes qui contribuent à la création de la réalité.

# Hundreds of components, thousands of lighting ideas Setki komponentów, tysiące pomysłów na oświetlenie Hunderte von Komponenten, tausende von Beleuchtungs-ideen Des centaines de composants, des milliers d'idées d'éclairage

Our products are our own projects and registered designs made in Europe.  
Our offer is clear and systemic.  
Thanks to the development of our staff and machinery we introduce new technologies, optimise production and logistics.  
We provide extensive sales support—from the convenient B2B platform to sample displays.

We participate in the most important lighting trade fairs.

Nasze produkty to autorskie projekty, wzory zastrzeżone i produkcja europejska.  
Nasza oferta jest czytelna i systemowa.  
Dzięki rozwojowi kadry i parku maszynowego, wprowadzamy kolejne technologie, optymalizujemy produkcję i logistykę.  
Zapewniamy szerokie wsparcie sprzedażowe – począwszy od wygodnej platformy B2B, a na ekspozytorach z próbkami skończywszy.

Wystawiamy się na najważniejszych imprezach targowych z branży oświetleniowej.

Unsere Produkte sind Eigenprodukte, Muster vorbehalten und europäische Produktion.  
Unser Angebot ist transparent und wird als Systemangebot vorgeschlagen.  
Dank Entwicklung des Personals und des Maschinenparks werden weitere Technologien eingeführt, die Herstellung und die Logistik werden optimiert.  
Wir bieten umfangreiche Verkaufsunterstützung - angefangen von einer bequemen B2B-Plattform, über Ausstellungsstände, bis auf Warenmuster.

Wir sind auf den bedeutendsten Messen in der Beleuchtungsbranche präsent.

Nos produits, c'est de conceptions originales et modèles déposés, tous produits en Europe.  
Notre offre est claire et méthodique.  
Grâce au développement du personnel et des machines, nous introduisons de nouvelles technologies et optimisons la production et la logistique.  
Nous fournissons le soutien commercial – en commençant par la plateforme B2B pratique jusqu'aux présentoirs d'échantillons.  
Nous sommes présents aux foires commerciales d'éclairage les plus importantes.

## TOPMET IN THE WORLD

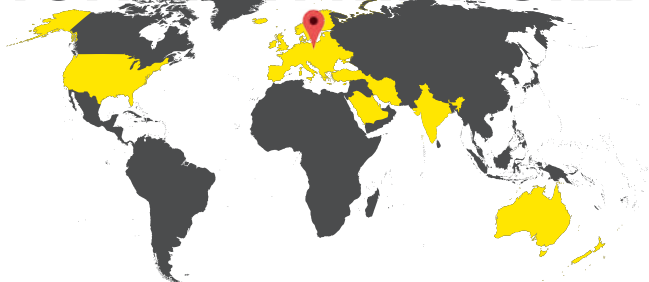

We are a reliable manufacturer and supplier with headquarters in central Europe.  
We reach almost 70 countries around the globe and continue to expand our cooperation network.  
We guarantee short order lead times thanks to fully stocked warehouses and convenient logistics.  
Create light with the TOPMET products!

Jesteśmy stabilnym producentem i dostawcą z siedzibą w centrum Europy.  
Docieramy do ponad 70 krajów na całym świecie i ciągle rozwijamy sieć współpracy.  
Zapewniamy krótki czas realizacji zamówień, dzięki pełnym magazynom oraz wygodnej logistyce.

Kreuj światło z produktami TOPMET!

Wir sind ein stabiler Hersteller und Lieferant mit Sitz im Zentrum Europas. Wir beliefern über 70 Länder auf der ganzen Welt und das Kooperationsnetz wird kontinuierlich weiterentwickelt.  
Wir bieten schnelle Abwicklung von Aufträgen dank ausreichenden Lagerbeständen und optimaler Logistik.  
Kreieren Sie das Licht mit den Produkten von TOPMET!

TOPMET est un fabricant et fournisseur fiable établi en Europe centrale.  
Nous desservons plus de 70 pays du monde et nous continuons d'élargir notre réseau de coopération.  
Nous garantissons des délais de livraison courts, grâce aux entrepôts bien remplis et une logistique pratique.  
Créez la lumière avec les produits de TOPMET!



# ACCESSORIES FOR LED SYSTEM - DIFFUSERS

## SYSTEMOWE AKCESORIA LED - KLOSZE

### ZUBEHÖR FÜR LED-SYSTEME - ABDECKUNGEN

#### ACCESSOIRES POUR SYSTEMES LED - DIFFUSEURS

	A	A1	A9	B	C	C1	C2	C3	C4	C9	C10	D	D9	E	E7	E9	F	G	H	I	J	K	
SLIM8 AC2/Z → 32	■						■																
SMART10 AC2/Z → 34	■																						
BEGTON12 J/S → 36																						■	
UNI12 BCD/U → 38				■	■							■											■
SURFACE10 BC/UX → 40				■	■																		
SURFACE10.v2 BC/U → 42				■	■																		
SURFACE14 EE7F/TY → 44															■	■		■					
SURFACE14.v2 EE7F/Y → 46															■	■		■					
SMART16 BC3/U4 → 48				■						■													
LINEA20 EE7F/TY → 50															■	■		■					
WIDE24 G/W → 56															■	■			■				
VARIO30-01 ACDE-9/TY → 59			■							■				■			■						
VARIO30-02 ACDE-9/TY → 60			■							■				■			■						
VARIO30-03 ACDE-9/TY → 63			■							■				■			■						
COMBO30-01 ACDE-9 → 71			■							■				■			■						
COMBO30-02 Q9 → 73																							
COMBO30-03 C4/Q9 → 73									■														
NAMI23 CD-9 → 76									■	■				■									
LOWI C10 → 78												■											
PHIL53 C10 → 80												■											
SLASH8 → 84																							
HI8 C1 → 86							■																
SMART-IN10 AC2/Z → 88	■							■															
BEGTIN12 J/S → 90																						■	
GROOVE10 BC/UX → 92				■	■																		
GROOVE10.v2 A1C/U → 94		■		■	■																		
GROOVE14 EE7F/TY → 96															■	■		■					
GROOVE14.v2 BC3/Y → 98									■						■	■		■					
DIAGONAL14 F/TY → 100																							
DEEP10 BC/UX → 102				■	■																		
SMART-IN16 BC3/U4 → 104				■					■														
LINEA-IN20 EE7F/U7 → 106															■	■		■					
VARIO30-06 ACDE-9/U9 → 111			■							■				■			■						
VARIO30-07 ACDE-9/U9 → 112			■							■				■			■						
FLAT8 H/UX → 114																						■	
PHIL recessed/ wpust / Einbau / entrée C10 → 116												■											
QUARTER10 BD/U6 → 120				■									■										
CABI12 E → 122																							
CABI12 DUO E → 124																							
CORNER10 BC/UX → 126				■	■																		
CORNER10.v2 A1C/U1 → 128		■		■	■																		
CORNER14 EE7F/TY → 130															■	■		■					
CORNER12.v2 EF/U → 132															■	■		■					
OMNI10 AC2 → 136	■									■													
GLOW12 UP A1C → 140		■			■																		
GLOW12 DOWN A1C → 142		■			■																		
FRAME14 BC/Q → 144				■	■																		
SMOOTH12 BC/Q9 → 146				■	■																		
HIDE10 C4 → 148										■													
LINEA-IN20 TRIMLESS EE7F → 150															■	■		■					
VARIO30-04 ACDE-9 → 153			■								■			■			■						
VARIO30-05 ACDE-9 → 154			■								■			■			■						
FLOOR8 K → 158																							■
FLOOR12 K/U → 160																							■
UP-TILE10 A → 162	■																						
UNI-TILE12 90 deg / st / Grad / degrés C → 165					■	■																	
UNI-TILE12 180 deg / st / Grad / degrés C → 166					■	■																	
UNI-TILE12 270 deg / st / Grad / degrés C → 167					■	■																	
ARC12 CD/U5 → 170													■										
PEN8 I → 172																						■	
PEN12 CJ → 174																						■	
BACK10 A/UX → 176	■																						
WAY10 C → 178																							
WALLE12 BCD → 180				■	■								■										
UP-MINI10 A → 182	■																						
UP-BOLD12 K → 184																							■
SKIRT10 AC2/Q9 → 186	■																						■



# ACCESSORIES FOR LED SYSTEM - MOUNTINGS

## SYSTEMOWE AKCESORIA LED - MOCOWANIA

### ZUBEHÖR FÜR LED-SYSTEME - HALTER

#### ACCESSOIRES POUR SYSTEMES LED - FIXATIONS

	Q	Q9	S	T	U	U1	U4	U5	U6	U7	U9	W	X	Y	Z
SLIM8 AC2/Z → 32															
SMART10 AC2/Z → 34															
BEGTON12 J/S → 36															
UNI12 BCD/U → 38															
SURFACE10 BC/UX → 40															
SURFACE10.v2 BC/U → 42															
SURFACE14 EE7F/TY → 44															
SURFACE14.v2 EE7F/Y → 46															
SMART16 BC3/U4 → 48															
LINEA20 EE7F/TY → 50															
WIDE24 G/W → 56															
VARIO30-01 ACDE-9/TY → 59															
VARIO30-02 ACDE-9/TY → 60															
VARIO30-03 ACDE-9/TY → 63															
COMBO30-01 ACDE-9 → 71															
COMBO30-02 Q9 → 73															
COMBO30-03 C4/Q9 → 73															
NAMI23 CD-9 → 76															
LOWI C10 → 78															
PHIL53 C10 → 80															
SLASH8 → 84															
HI8 C1 → 86															
SMART-IN10 AC2/Z → 88															
BEGTIN12 J/S → 90															
GROOVE10 BC/UX → 92															
GROOVE10.v2 A1C/U → 94															
GROOVE14 EE7F/TY → 96															
GROOVE14.v2 BC3/Y → 98															
DIAGONAL14 F/TY → 100															
DEEP10 BC/UX → 102															
SMART-IN16 BC3/U4 → 104															
LINEA-IN20 EE7F/U7 → 106															
VARIO30-06 ACDE-9/U9 → 111															
VARIO30-07 ACDE-9/U9 → 112															
FLAT8 H/UX → 114															
PHIL recessed/ wpust / Einbau / entrée C10 → 116															
QUARTER10 BD/U6 → 120															
CABI12 E → 122															
CABI12 DUO E → 124															
CORNER10 BC/UX → 126															
CORNER10.v2 A1C/U1 → 128															
CORNER14 EE7F/TY → 130															
CORNER12.v2 EF/U → 132															
OMNI10 AC2 → 136															
GLOW12 UP A1C → 140															
GLOW12 DOWN A1C → 142															
FRAME14 BC/Q → 144															
SMOOTH12 BC/Q9 → 146															
HIDE10 C4 → 148															
LINEA-IN20 TRIMLESS EE7F → 150															
VARIO30-04 ACDE-9 → 153															
VARIO30-05 ACDE-9 → 154															
FLOOR8 K → 158															
FLOOR12 K/U → 160															
UP-TILE10 A → 162															
UNI-TILE12 90 deg / st / Grad / degrés C → 165															
UNI-TILE12 180 deg / st / Grad / degrés C → 166															
UNI-TILE12 270 deg / st / Grad / degrés C → 167															
ARC12 CD/U5 → 170															
PEN8 I → 172															
PEN12 CJ → 174															
BACK10 A/UX → 176															
WAY10 C → 178															
WALLE12 BCD → 180															
UP-MINI10 A → 182															
UP-BOLD12 K → 184															
SKIRT10 AC2/Q9 → 186															

# WHY LED PROFILES? DLACZEGO PROFILE LED? WARUM LED PROFILE? POURQUOI DES PROFILÉS LED ?

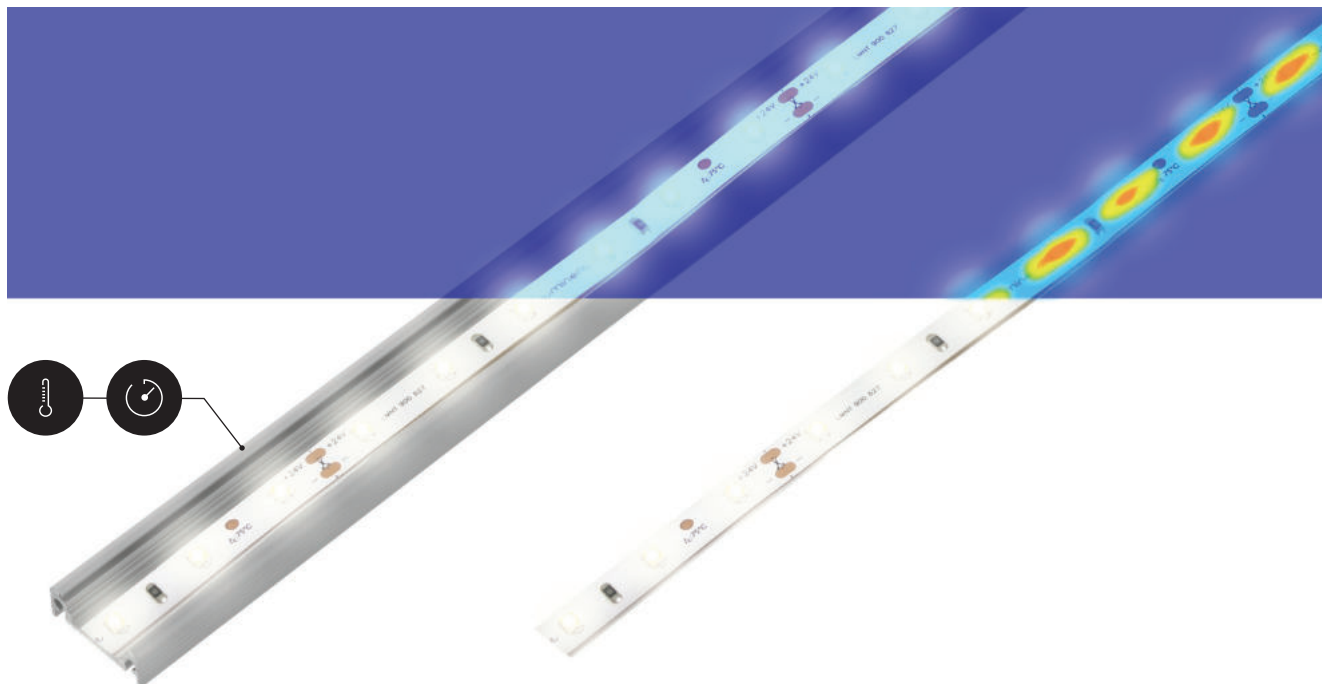

## HEAT DISSIPATION

An aluminium profile is a radiator - it dissipates heat from the LED source. Lower temperature means better operating conditions for the diodes, therefore, extension of the LED lifespan and better illumination parameters. It also translates to economic considerations - LED does not require such frequent replacement of light sources. An aluminium profile is an investment, which pays off.

Some LED sources available on the market may exceed radiation capabilities of a given aluminium profile. In order to ensure correct operation, a LED source with appropriate parameters needs to be matched to an aluminium profile.

## ODPROWADZANIE CIEPŁA

Profil aluminiowy jest radiatorem – odprowadza ciepło ze źródła LED. Niższa temperatura to lepsze warunki pracy dla diod, a tym samym przedłużenie żywotności LED i lepsze parametry świetlne. Przekłada się to również na względy ekonomiczne – LED nie wymaga tak częstych wymian źródeł światła. Profil aluminiowy to inwestycja, która się opłaca.

Niektóre źródła LED dostępne na rynku mogą przekraczać radiacyjne możliwości wybranego profilu aluminiowego. W celu zapewnienia poprawnego działania, należy dobrać do profilu aluminiowego źródło LED o odpowiednich parametrach.

## WÄRMEABFUHR

Das LED Profil ist ein Radiator - es strahlt die Wärme aus der LED Lichtquelle ab. Eine niedrigere Temperatur bedeutet bessere Arbeitsbedingungen für die LEDs, was Einfluss auf ihre Lebensdauer hat und bessere Lichtparameter sichert. Das hat auch einen Einfluss auf den ökonomischen Aspekt, denn LED Lichtquellen müssen nicht so oft getauscht werden. Das LED Aluminiumprofil ist eine Investition, die sich lohnt.

Einige auf dem Markt zugängliche LED Lichtquellen, können die Wärmeabfuhrmöglichkeiten des gewählten Aluminiumprofils überschreiten. Damit das LED Profil richtig funktioniert, soll man eine LED Lichtquelle mit entsprechenden Lichtparametern wählen.

## DISSIPATION DE LA CHALEUR

Le profilé en aluminium est un dissipateur de chaleur - il dissipe la chaleur de la source LED. Une température plus basse signifie de meilleures conditions de travail pour les LED et prolonge ainsi la durée de vie de la LED et assure de meilleurs paramètres d'éclairage. Cela se traduit également par des considérations économiques - la LED ne nécessite pas un remplacement aussi fréquent de la source lumineuse. Le profilé en aluminium est un investissement rentable.

Certaines sources LED disponibles sur le marché peuvent dépasser les capacités de rayonnement du profilé en aluminium sélectionné. Afin d'assurer un bon fonctionnement, une source LED doit être équipée d'un profilé en aluminium approprié.



#### AESTHETICS / STRIP PROTECTION

An aluminium profile is a protection for a LED source against mechanical damage. The assembly is much more durable in comparison to gluing a LED strip directly to the surface. Using a profile increases aesthetics and facilitates maintaining cleanliness.

#### ESTETYKA / OCHRONA TAŚMY

Profil aluminiowy stanowi zabezpieczenie źródła LED przed mechanicznym uszkodzeniem. Montaż jest znacznie trwalszy w porównaniu z przyklejeniem taśmy LED bezpośrednio do podłoża. Użycie profilu podwyższa estetykę oraz ułatwia utrzymanie czystości.

#### ÄSTHETIK / SCHUTZ DES LED STREIFENS

Das LED Aluminiumprofil bildet eine Art Schutz der LED Lichtquelle vor mechanischen Beschädigungen. Die Montage ist viel fester im Vergleich zum Ankleben. Das Anwenden von einem LED Profil erhöht die ästhetische Seite und sorgt für Sauberhaltung.

#### ESTHÉTIQUE / PROTECTION DU RUBAN

Le profilé en aluminium protège la source LED contre les dommages mécaniques. L'installation est beaucoup plus durable que de coller le ruban LED directement sur le support. L'utilisation du profilé augmente l'esthétique et facilite le nettoyage.

# WHY LED PROFILES? DLACZEGO PROFILE LED? WARUM LED PROFILE? POURQUOI DES PROFILÉS LED ?



## ANODIZED COATING COLOUR VERSIONS

In the standard TOPMET offer, aluminium LED profiles are available in 4 basic finishes:

- white painted - powder coated,
- anodised aluminium in silver colour,
- anodised aluminium in black colour,
- raw aluminium - economic version, not resistant to damage.

The most eagerly used ones are the anodized versions with a high degree of scratch resistance. The thickness of the anodic coating on all our profiles is about 15 µm.

## ANODOWANA POWŁOKA WERSJE KOLORYSTYCZNE

W standardowej ofercie TOPMET profile aluminiowe LED występują w 4 podstawowych wykończeniach:

- biały malowany – powłoka farby proszkowej,
- aluminium anodowane w kolorze srebrnym,
- aluminium anodowane w kolorze czarnym,
- aluminium surowe – wersja ekonomiczna, nieodporna na uszkodzenia.

Najchętniej stosowane są wersje anodowane o wysokim stopniu odporności na zarysowania. Grubość powłoki anodowej na wszystkich naszych profilach to około 15 µm.

## ELOXIERTE BESCHICHTUNG FARBVERSIONEN

TOPMET bietet standardmäßig die LED Profile in vier Ausführungen:

- Weiß lackiert - pulverbeschichtet,
- eloxiertes Aluminium in silbern,
- eloxiertes Aluminium in schwarz, weiß
- Rohaluminium - kostengünstige Variante, schadensanfällig.

Am meisten wird die eloxierte Version, mit einem hohen Grad der Beständigkeit gegen Kratzer angewendet. Die Dicke des Eloxals auf allen unseren Profilen liegt bei ca. 15 µm.

## REVÊTEMENT ANODISÉ VERSIONS COULEURS

Dans l'offre TOPMET standard, les profilés aluminium LED sont disponibles en 4 finitions de base :

- peint en blanc – revêtement de peinture en poudre,
- aluminium anodisé argent,
- aluminium anodisé noir,
- aluminium brut – version économique, non résistant aux rayures.

Les versions les plus couramment utilisées sont les versions anodisées avec un haut degré de résistance aux rayures. L'épaisseur du revêtement anodique sur tous nos profilés est d'environ 15 µm.



#### ACCESSORIES

The design department is constantly working on expanding the offer with further components, which facilitate the assembly and multiply the possibilities of combinations, connections and assembly. Apart from system mounting plates, which match different profiles, many collections also have dedicated solutions for more advanced, specialist needs. The accessories for LED profiles include, i.a.: end caps, diffusers, mounting plates, holders, connectors, slings and many more.

#### AKCESORIA

Dział projektowy stale pracuje nad wzbogaceniem oferty w kolejne komponenty, które ułatwiają montaż i zwielokrotniają możliwości kombinacji, połączeń, montażu. Poza uchwytami systemowymi, pasującymi do różnych profili, wiele kolekcji ma także dedykowane rozwiązania do bardziej zaawansowanych, specjalistycznych potrzeb. Wśród akcesoriów do profili LED są m.in.: zaślepki, klosze, uchwyty, łączniki, zawieszki i wiele innych.

#### ZUBEHÖR

Unsere Projektabteilung arbeitet ständig an der Erweiterung des Angebotes um weitere Komponenten, die die Montage vereinfachen und die Kombinations-, Verbindungs- und Montagemöglichkeiten vervielfachen. Außer den Haltern, die mit mehreren Profilen kompatibel sind, haben viele Typen der Profile auch eigene Lösungen für mehr fortgeschrittene, spezielle Bedürfnisse. Unter den Zubehörteilen für LED Profile gibt es u.a. Endkappen, Abdeckungen, Halter, Ausleger, Verbinder, Klemmen, Abhängungen und viele andere.

#### ACCESSOIRES

Le bureau d'études travaille en permanence à enrichir l'offre avec de nouveaux composants qui facilitent l'assemblage et multiplient les possibilités de combinaisons, de connexions et d'assemblages. En plus des fixations système qui correspondent à différents profilés, de nombreuses collections ont également des solutions dédiées pour des besoins plus avancés et spécialisés. Parmi les accessoires pour profilés LED, on trouve, entre autres : des embouts, des diffuseurs, des fixations, des connecteurs, des dispositifs de suspension et bien d'autres.

#### DESIGN / PRODUCTION

All profiles are unique - designed by TOPMET designers. All the designs are registered - legally protected throughout the European Union. TOPMET profiles, accessories and luminaires are manufactured in Poland.

#### PROJEKT / PRODUKCJA

Wszystkie profile są unikatowe - zaprojektowane przez projektantów TOPMET. Wszystkie wzory są zarejestrowane - chronione prawnie na terenie całej Unii Europejskiej. Profile, akcesoria i oprawy TOPMET wyprodukowane są w Polsce.

#### ENTWURF / FERTIGUNG

Alle Profile sind einzigartig - entwickelt von TOPMET Designern. Alle Modelle sind registriert worden - gesetzlich geschützt in ganz Europa. Die Profile, das Zubehör und die Leuchten von TOPMET sind in Polen hergestellt.

#### CONCEPTION / PRODUCTION

Tous les profilés sont uniques - conçus par les designers TOPMET. Tous les modèles sont enregistrés - protégés légalement dans toute l'Union européenne. Les profilés, accessoires et fixations TOPMET sont fabriqués en Pologne.



EU-registered industrial design  
wzory przemysłowe EU  
EU Industriedesign  
Dessins et modèles industriels de l'UE



made in Poland  
wyprodukowane w Polsce  
in Polen hergestellt  
Fabriqué en Pologne

WHAT DOES A PROFILE NAME INDICATE?  
 CO OZNACZA NAZWA PROFILU?  
 WAS SAGT UNS DER NAME DES PROFILS?  
 QUE SIGNIFE LE NOM DU PROFILÉ ?

# SURFACE10 BC/UX

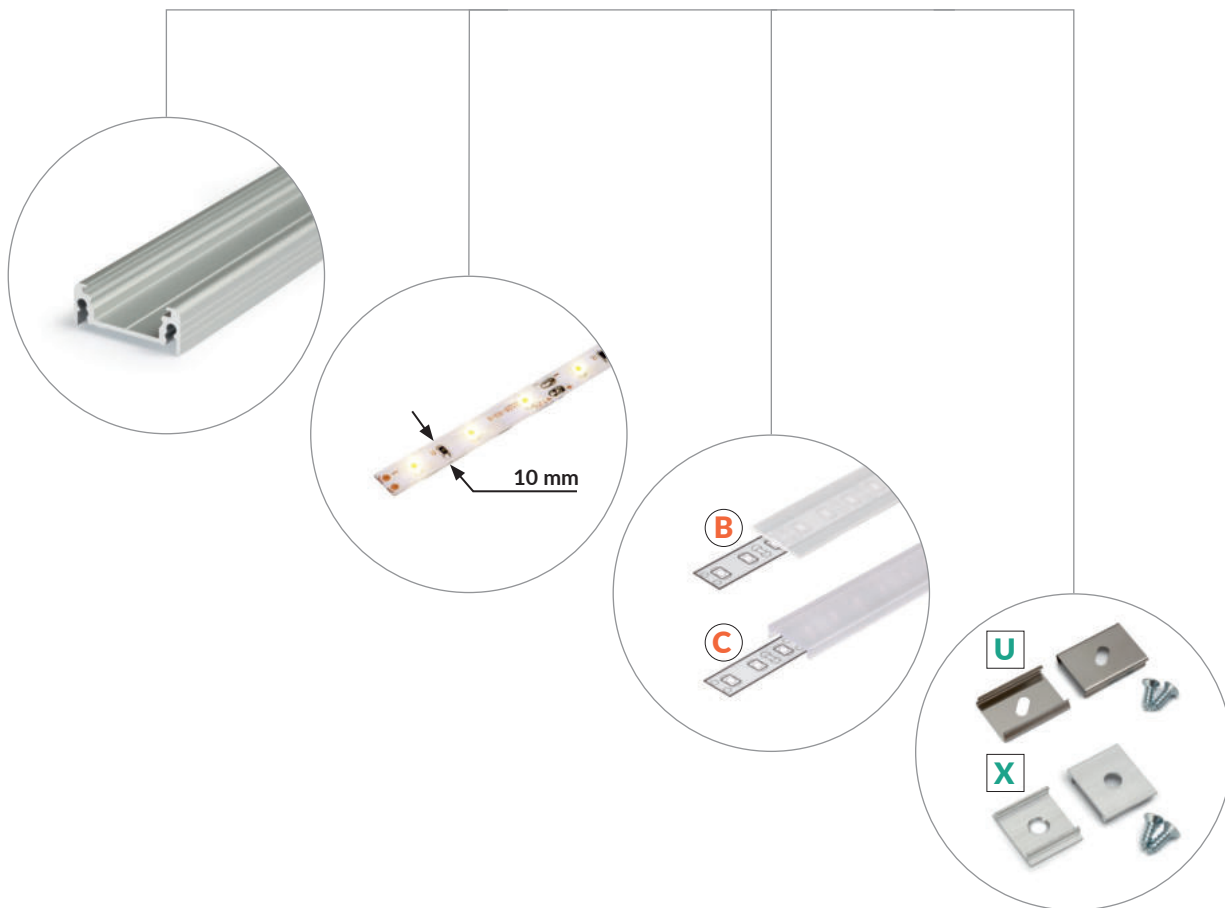

marking of diffusers fitting the sockets in the profile  
 oznaczenia kloszy pasujących do gniazd w profilu  
 die Bezeichnung der Abdeckungen, die mit den Befestigungssockeln in dem Profil passen  
 désignation de diffuseurs selon leur type de montage

**A A1 A9 B C C1 C2 C3 C4 C9 C10 D D9 E E7 E9 F G H I J K**

marking of mountings fitting the profile  
 oznaczenia mocowań pasujących do profilu  
 Bezeichnungen der Halter, die zu dem Profil passen.  
 désignation de fixations correspondant au profilé

**Q Q9 S T U U1 U4 U5 U6 U7 U9 W X Y Z**



# MARKINGS OZNACZENIA BEZEICHNUNGEN DÉSIGNATIONS

## PROFILE WITH SLICK SOCKET

We also have profiles with the Slick socket in our assortment. This feature allows to click in or slide in the diffuser.

SLIM8 AC2/Z → 32  
 SMART10 AC2/Z → 34  
 BEGTON12 J/S → 36  
 SURFACE10.v2 BC/U → 42  
 SURFACE14.v2 EE7F/Y → 46  
 SMART16 BC3/U4 → 48  
 LINEA20 EE7F/TY → 50  
 WIDE24 G/W → 56  
 VARIO30-01 ACDE-9/TY → 59  
 VARIO30-02 ACDE-9/TY → 60  
 VARIO30-03 ACDE-9/TY → 63  
 COMBO30-01 ACDE-9 → 71  
 SMART-IN10 AC2/Z → 88  
 BEGTIN12 J/S → 90  
 GROOVE10.v2 A1C/U → 94  
 GROOVE14.v2 BC3/Y → 98  
 SMART-IN16 BC3/U4 → 104  
 LINEA-IN20 EE7F/U7 → 106  
 VARIO30-06 ACDE-9/U9 → 111  
 VARIO30-07 ACDE-9/U9 → 112  
 QUARTER10 BD/U6 → 120  
 CABI12 E → 122  
 CABI12 DUO E → 124  
 CORNER10.v2 A1C/U1 → 128

## PROFIL Z GNIAZDEM SLICK

W naszym asortymencie posiadamy także profile z gniazdem Slick. Funkcja ta pozwala na łatwe „wklikiwanie” lub wsuwanie klosza.

## PROFILE MIT DER SLICK FUNKTION

In unserem Sortiment haben wir auch LED Profile mit einem Slick Befestigungssockel. Diese Funktion ermöglicht ein einfaches Einclippen oder Einschieben der Abdeckung.

## PROFILÉ AVEC LA FONCTION SLICK

Notre assortiment comprend également des profilés avec une solution Slick. Cette fonction vous permet de « cliquer » ou d'insérer facilement le diffuseur.

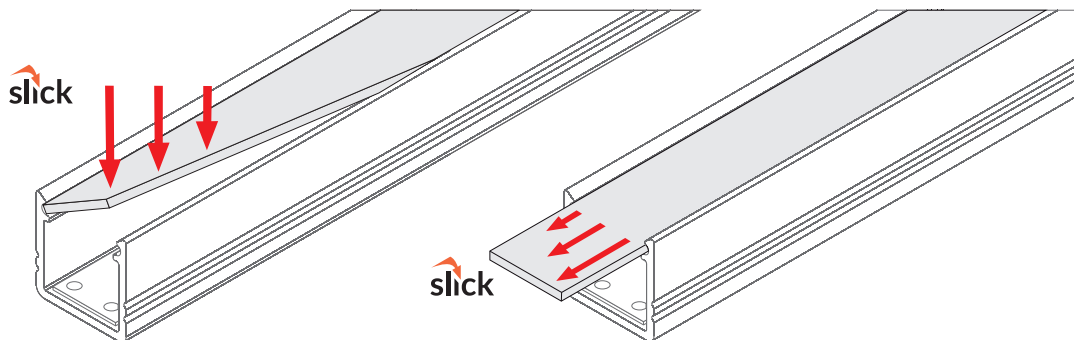

assembly  
montaż  
Montage  
montage

removal  
demontaż  
Démontage  
démontage

CORNER12.v2 EF/U → 132  
 OMNI10 AC2 → 136  
 GLOW12 UP A1C → 140  
 GLOW12 DOWN A1C → 142  
 LINEA-IN20 TRIMLESS EE7F → 150

VARIO30-04 ACDE-9 → 153  
 VARIO30-05 ACDE-9 → 154  
 UP-TILE10 A → 162  
 UP-MINI10 A → 182  
 SKIRT10 AC2/Q9 → 186

LED profile industry categories  
kategorie branżowe profili LED  
LED Profil Branchenkategorien  
profilés LED dédiés à l'industrie



furniture  
meblowe  
Möbel-  
mobilier



architectural  
architektoniczne  
architektonisch  
architecture



lighting  
oświetleniowe  
Beleuchtungs-  
éclairage

LED profile application categories  
kategorie montażowe profili LED  
Montagekategorien der LED Profile  
catégories de profilé LED



surface  
nawierzchniowy  
Aufbauprofile  
surface



suspended  
związany  
hängend  
suspendu



recessed  
wpustowy  
Einbauprofile  
à encastrer



corner  
kątowy  
Eckprofile  
d'angles



special application  
specjalny  
spezielle Profile  
spécial



plaster-in  
do szpachlowania  
zum Spachteln  
pour le remplissage



tile-in  
do płytek  
für Fliesen  
pour les carreaux

others  
inne  
sonstige  
autres



maximum LED strip width  
maksymalna szerokość taśmy LED  
maximale Breite des LED Streifens  
largeur maximale de ruban LED



note  
uwaga  
Achtung  
attention



assembly adhesive  
klej montażowy  
Montageklebstoff  
colle de montage



sling  
zawiesie  
Abhängung  
suspension



made in Poland  
wyprodukowane w Polsce  
in Polen hergestellt  
fabriqué en Pologne



EU-registered industrial design  
wzory przemysłowe EU  
EU Industriemuster  
dessins et modèles industriels de l'UE

# HOW TO SELECT A DIFFUSER? JAK DOBRAĆ KLOSZ? WIE WÄHLT MAN DIE ABDECKUNG? COMMENT CHOISIR UN DIFFUSEUR ?

Diffusers for aluminium LED profiles differ in the level of transparency. Thanks to a conscious choice, you can plan the lighting effect, light dispersion and distribution better. A transparent diffuser absorbs a smaller amount of light, followed by frosted and opal ones.

Klosze do profili aluminiowych LED różnią się stopniem transparentności. Dzięki świadomemu wyborowi można lepiej zaplanować efekt świetlny, rozproszenie i rozsył światła. Klosz transparentny pochłania najmniejszą ilość światła, dalej szron i mleczny.

Die Abdeckungen für die LED Profile unterscheiden sich mit dem Grad der Lichtdurchlässigkeit. Eine bewusste Wahl ermöglicht besser den Lichteffect, die Lichtzerstreuung und Lichtverteilung einzuplanen. Die transparente Abdeckung nimmt am wenigsten Licht auf, danach ist die satinierte und opale Abdeckung.

Les diffuseurs pour les profilés en aluminium LED diffèrent par le degré de transparence. Grâce à un choix conscient, vous pouvez mieux planifier l'effet d'éclairage, la diffusion et la distribution de la lumière. Le diffuseur transparent absorbe la plus petite quantité de lumière, ensuite le diffuseur givré et opaque.

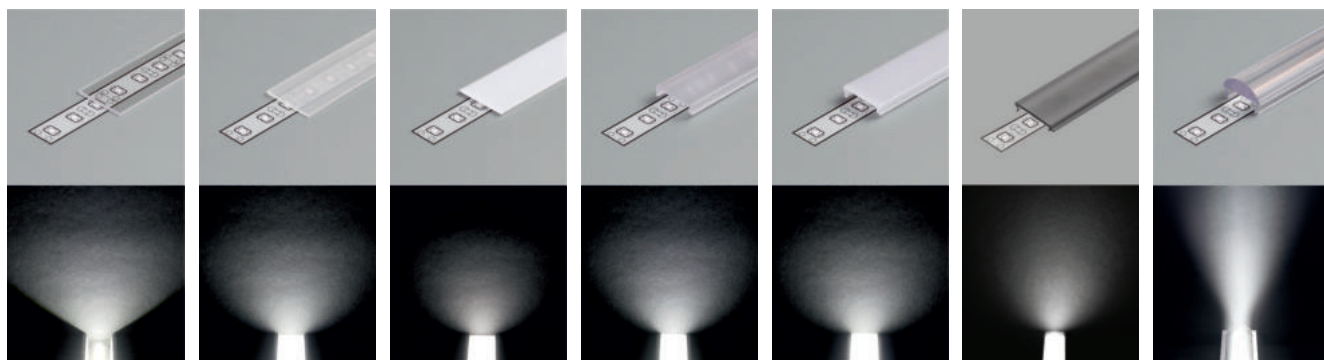

**B** slide transparent  
**B** wsuwany transparentny  
**B** einschiebbar transparent  
**B** couissant transparent

**B** slide frosted  
**B** wsuwany szron  
**B** einschiebbar satiniert  
**B** couissant givré

**B** slide opal  
**B** wsuwany mleczny  
**B** einschiebbar opal  
**B** couissant opaque

**C** click transparent  
**C** klik transparentny  
**C** einclipsbar transparent  
**C** clic transparent

**C** click opal  
**C** klik mleczny  
**C** einclipsbar opal  
**C** clic opaque

**C** click black  
**C** klik czarny  
**C** einclipsbar schwarz  
**C** clic noir

**C** click lens  
**C** klik soczewka  
**C** einclipsbar Linse  
**C** clic lentille

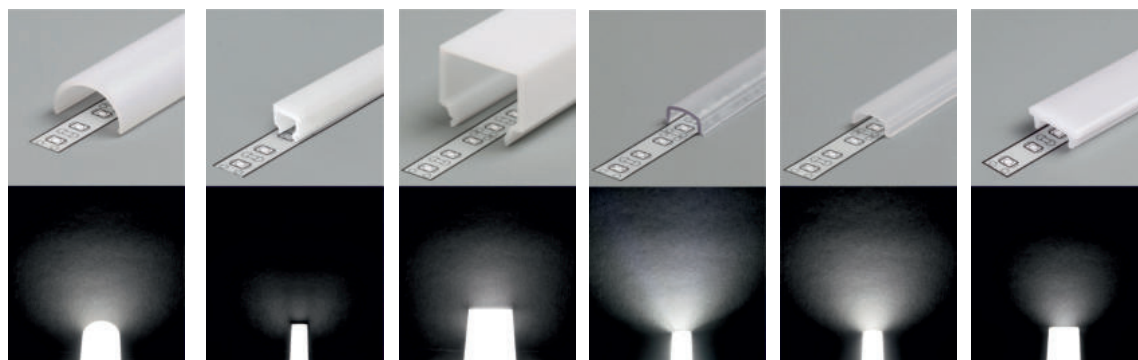

**D** click opal  
**D** klik mleczny  
**D** einclipsbar opal  
**D** clic opaque

**C1** click opal  
**C1** klik mleczny  
**C1** einclipsbar opal  
**C1** clic opaque

**E7** click opal  
**E7** klik mleczny  
**E7** einclipsbar opal  
**E7** clic opaque

**I** click frosted  
**I** klik szron  
**I** einclipsbar satiniert  
**I** clic givré

**I** click opal  
**I** klik mleczny  
**I** einclipsbar opal  
**I** clic opaque

**K** click opal  
**K** klik mleczny  
**K** einclipsbar opal  
**K** clic opaque



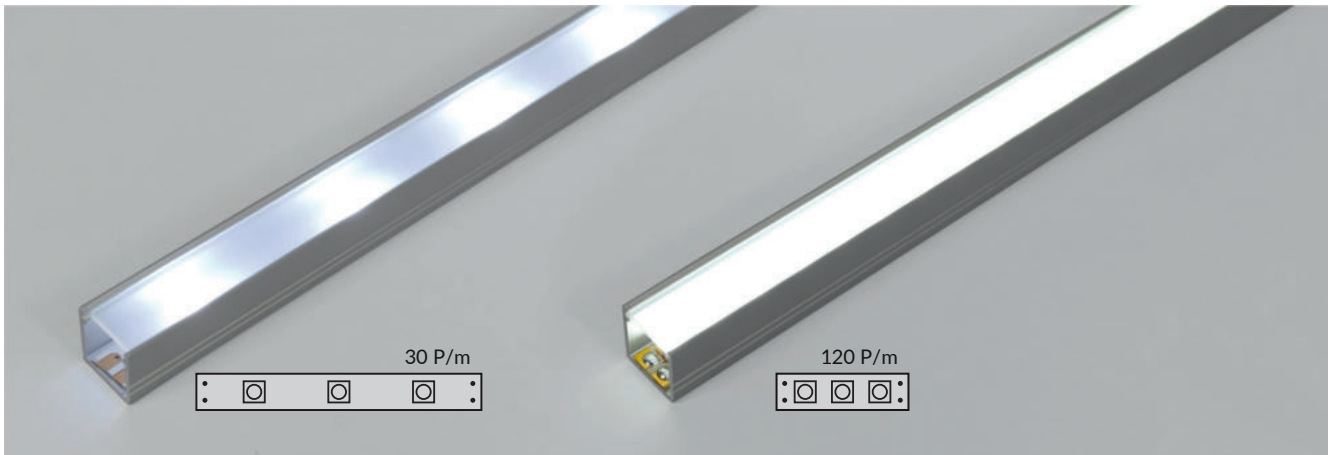

It also means a different degree of visibility of LED points. Opal diffuser in some profiles, in conjunction with a 120 P/m tape, allow to achieve the effect of a continuous line of light.

Oznacza to także różny stopień widoczności punktów LED. Klosze mleczne w niektórych profilach w połączeniu z taśmą 120 P/m pozwalają osiągnąć efekt ciągłej linii światła.

Das bedeutet auch verschiedene Stufe der Sichtbarkeit von LED Punkten. Wenn man in einigen Profilen opale Abdeckungen und ein LED Streifen mit 120 LEDs anwendet, gibt es den Effekt einer homogenen Lichtlinie.

Cela signifie également un degré différent de visibilité des points LED. Les diffuseurs opaques dans certains profilés en combinaison avec un ruban 120 P/m permettent d'obtenir l'effet d'une ligne continue de lumière.

#### THE DIFFUSERS ALSO DIFFER IN THE METHOD OF ASSEMBLY

#### KLOSZE RÓŻNIĄ SIĘ TAKŻE SPOSOBEM MONTAŻU

#### ABDECKUNGEN UNTERSCHIEDEN SICH AUCH DURCH DIE ART UND WEISE DER MONTAGE.

#### LES DIFFUSEURS DIFFÈRENT ÉGALEMENT PAR LA METHODE DE MONTAGE

**SLIDE DIFFUSER**  
(labelling: A, A1, A9, B, E, G, H, J)  
It is a strip of plastic available in 3 different degrees of transparency. It needs to be slid from the beginning of the profile and dragged along the marked socket or clicked in the Slick socket.

**KLOSZ WSUWANY**  
(oznaczenia: A, A1, A9, B, E, G, H, J)  
Jest to pasek tworzywa dostępny w 3 różnych stopniach transparentności. Należy go wsunąć od początku profilu i przeciągnąć wzdłuż oznaczonego gniazda lub „wkliknąć” w gniazdo Slick.

**ABDECKUNG ZUM EINSCHIEBEN**  
(Bezeichnung: A, A1, A9, B, E, G, H, J)  
Das ist ein Streifen aus Kunststoff mit drei unterschiedlichen Graden der Lichtdurchlässigkeit. Man soll die Abdeckung vom Anfang des Profils einschieben und entlang des markierten Sockels ziehen oder in die Slick Befestigungssockel einclippen.

**DIFFUSEUR COULISSANT**  
(désignations: A, A1, A9, B, E, G, H, J)  
Il s'agit de ruban en plastique disponible en 3 niveaux de transparence différents. Il doit être inséré depuis le début du profilé et tiré le long de la fente marquée ou « cliquer » dedans si le profilé a la fonction Slick.

#### CLICK DIFFUSER

(labelling: C, C1, C2, C3, C4, C9, C10, D, D9, E7, E9, F, I, K)  
Its assembly and removal are more convenient. Access to the ends of the profile is not necessary, which allows to click in the diffuser even after installing the profile in a recess or a piece of furniture.

**KLOSZ KLIK**  
(oznaczenia: C, C1, C2, C3, C4, C9, C10, D, D9, E7, E9, F, I, K)  
Jego montaż i demontaż jest wygodniejszy. Dostęp do końców profilu nie jest konieczny, co pozwala wkliknąć klosz nawet po zamontowaniu profilu nie w niszę lub w meble.

**ABDECKUNG ZU EINCLIPSEN**  
(Bezeichnung: C, C1, C2, C3, C4, C9, C10, D, D9, E7, E9, F, I, K)  
Die Montage und Demontage der Abdeckung ist bequemer. Der Zugang zu den Enden des Profils ist nicht notwendig, was das Einclippen der Abdeckung sogar nach der Montage des Profils in einer Nische oder einem Möbelstück ermöglicht.

**DIFFUSEUR CLIC**  
(désignations: C, C1, C2, C3, C4, C9, C10, D, D9, E7, E9, F, I, K)  
Son montage et son démontage sont plus pratiques. L'accès aux extrémités du profilé n'est pas nécessaire, ce qui permet au diffuseur de s'enclipser même après le montage du profilé dans une niche ou dans un meuble.

# HOW TO SELECT A DIFFUSER? JAK DOBRAĆ KLOSZ? WIE WÄHLT MAN DIE ABDECKUNG? COMMENT CHOISIR UN DIFFUSEUR ?



## SYSTEM ACCESSORIES

Many of the diffusers in the TOPMET offer are system accessories.  
It means that one diffuser fits a few, different profiles.

A letter describing the socket helps correct matching.  
And so, e.g., the SURFACE10 BC/UX profile can be fitted with the diffusers:

- B slide
- C click
- C lens

Diffuser C click, on the other hands, fits the profiles:

UNI12 BCD/U → 38  
SURFACE10 BC/UX → 40  
SURFACE10.v2 BC/U → 42  
GROOVE10 BC/UX → 92  
GROOVE10.v2 A1C/U → 94  
DEEP10 BC/UX → 102  
CORNER10 BC/UX → 126  
CORNER10.v2 A1C/U1 → 128  
GLOW12 UP A1C → 140  
GLOW12 DOWN A1C → 142  
FRAME14 BC/Q → 144  
SMOOTH12 BC/Q9 → 146  
UNI-TILE12 C → 164  
ARC12 CD/U5 → 170  
PEN12 CJ → 174  
WAY10 C → 178  
WALLE12 BCD → 180

## AKCESORIA SYSTEMOWE

W ofercie TOPMET wiele spośród kloszy to akcesoria systemowe.  
Oznacza to, że ten sam klosz pasuje do kilku różnych profili.

W odpowiednim dopasowaniu pomaga litera opisująca gniazdo.  
I tak np. do profilu LED SURFACE10 BC/UX pasują klosze:  
- B wsuwany  
- C klik  
- C soczewka  
Klosz C klik z kolei pasuje do profili:

## KOMPATIBLES ZUBEHÖR

Viele von den Abdeckungen aus dem TOPMET Angebot gelten als kompatibles Zubehör.  
Es bedeutet, dass die selbe Abdeckung mit mehreren Profilen zusammenpasst.

Bei dem richtigen Anpassen der Abdeckungen helfen die Buchstaben. Dementsprechend passen z. B. mit dem LED Profil SURFACE10 BC/UX folgende Abdeckungen zusammen:  
- B zum Einschieben  
- C zum Einclippen  
- C Linse  
Die Abdeckung C zum Einclippen passt wiederum mit folgenden Profilen zusammen:

## ACCESSOIRES COMPATIBLES

De nombreux diffuseurs de l'offre TOPMET sont des accessoires compatibles. Cela signifie que le même diffuseur s'adapte à plusieurs profilés différents.

La lettre décrivant type de diffuseur aide à la bonne correspondance.  
Ainsi, par exemple, le profilé LED SURFACE10 BC/UX convient aux diffuseurs :  
- B coulissant  
- C clic  
- C lentille  
Le diffuseur clic C, quant à lui, s'adapte aux profilés:

diffuser type rodzaj klosza Die Art der Abdeckung type de diffuseur	material materiał Das Material matériel	operating temperature temperatura stosowania Die Anwendungstemperatur température d'application		UV resistance odporność na UV UV- Beständigkeit résistance aux UV	fire hazard certificate* certyfikat na palność* Das Zertifikat für Brennbarkeit* certificat d'inflamma- -bilité*	transparency transparentność Lichtdurch- lässigkeit transparence
		min [°C]	max [°C]			
<b>A, A1, A9, B, E, G, H, J</b> transparent / transparentny transparent / transparent	PC	-30	100	✓	✓	95%
<b>A, A1, A9, B, E, G, H, J</b> frosted / szron / satiniert / givré	PP	-15	80	✓	✓	90%
<b>A, A1, A9, B, E, G, H, J</b> opal / mleczny / opal / opaque	PP	-15	80	✓	✓	60%
<b>C, F</b> transparent / transparentny transparent / transparent	PMMA	-20	70	✓	✓	95%
<b>C, F</b> opal / mleczny / opal / opaque	PMMA	-20	70	✓	✓	70%
<b>C, F</b> black / czarny / schwarz / noir	PMMA	-20	70	✓	✓	40%
<b>C</b> lens / soczewka / Linse / lentille	PMMA	-20	70	✓	✓	90%
<b>C1, D9, E7, E9</b> opal / mleczny / opal / opaque	PMMA	-20	70	✓	✓	70%
<b>C2</b> transparent / transparentny transparent / transparent	PMMA	-20	70	✓	✓	95%
<b>C2</b> opal / mleczny / opal / opaque	PMMA	-20	70	✓	✓	70%
<b>C2</b> black / czarny / schwarz / noir	PMMA	-20	70	✓	✓	40%
<b>C3, C9</b> transparent / transparentny transparent / transparent	PMMA	-20	70	✓	✓	95%
<b>C3, C9</b> opal / mleczny / opal / opaque	PMMA	-20	70	✓	✓	70%
<b>C3, C9</b> black / czarny / schwarz / noir	PMMA	-20	70	✓	✓	40%
<b>C4</b> opal / mleczny / opal / opaque	PC	-30	100	✓	✓	70%
<b>C10 OPAL</b> opal / mleczny / opal / opaque	PMMA	-20	70	✓	✓	75%
<b>C10 NARROW</b> black / czarny / schwarz / noir	PC	-30	100	✓	✓	90%
<b>C10 WIDE</b> opal / mleczny / opal / opaque	PC	-30	100	✓	✓	90%
<b>D</b> opal / mleczny / opal / opaque	PMMA	-20	70	✓	✓	60%
<b>I</b> frosted / szron / satiniert / givré	PC	-30	100	✓	✓	90%
<b>I</b> opal / mleczny / opal / opaque	PC	-30	100	✓	✓	80%
<b>K</b> opal / mleczny / opal / opaque	PC	-30	100	✓	✓	50%

# END CAPS ZAŚLEPKI ENDKAPPEN EMBOUTS

The end caps, with the aim to aesthetically close the profile and additionally protect the LED source, come in four basic colours: silver, white, black and grey. Some of the end caps are available in opal colour for opal diffusers.

The material used for the production of the end caps meets the lighting non-combustibility standard no.: PN-EN 60695-2-11.  
Material: ABS, PC, PMMA.

Zaślepki, mające na celu estetyczne domknięcie profilu oraz dodatkową ochronę źródła LED, występują w czterech podstawowych kolorach: srebrnym, białym, czarnym i szarym. Wybrane zaślepki dostępne są w wersji mlecznej do kloszy mlecznych.

Tworzywo użyte do produkcji zaślepek spełnia oświetleniową normę niepalności nr: PN-EN 60695-2-11.  
Materiał: ABS, PC, PMMA.

Die Endkappen erfüllen die Funktion einer ästhetischen Beendigung des Profils und eines zusätzlichen Schutzes der LED Lichtquelle.

Die Endkappen sind in vier Grundfarben zugänglich: silbern, weiß, schwarz und grau. Gewählte Endkappen sind in der Version opal für opale Abdeckungen erreichbar. Der Kunststoff, der für die Produktion von den Endkappen verwendet wird, erfüllt die Feuerbeständigkeitsnorm zur Beleuchtung Nummer: PN-EN 60695-2-11. Das Material: ABS, PC, PMMA.

Les embouts, destinées à la fermeture esthétique du profilé et à la protection supplémentaire de la source LED, sont disponibles en quatre couleurs de base : argent, blanc, noir et gris. Pour certains modèles de diffuseurs opaques nous proposons les embouts opaques assortis. Le matériau utilisé pour la fabrication des embouts répond à la norme d'inflammabilité de l'éclairage N°: PN-EN 60695-2-11. Matériel : ABS, PC, PMMA.

white  
biały  
weiß  
blanc



silver  
srebrny  
silbern  
argent

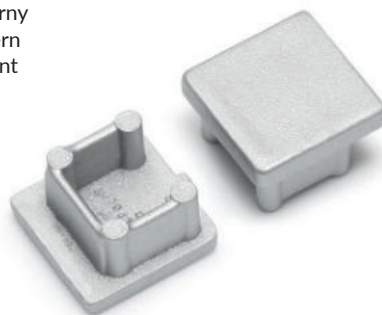

black  
czarny  
schwarz  
noir



grey  
szary  
grau  
gris



opal  
mleczny  
opal  
opaque



End caps with a hole or without it - which one to choose? Some of our end caps come in two versions:

Zaślepki z otworem czy bez - jakie wybrać? Część spośród naszych zaślepek występuje w dwóch wersjach:

Die Endkappen mit oder ohne Öffnung - welche wählt man? Viele von unseren Endkappen sind in zwei Versionen zugänglich:

Embouts avec ou sans trou - lequel choisir? Certains de nos embouts sont disponibles en deux versions :

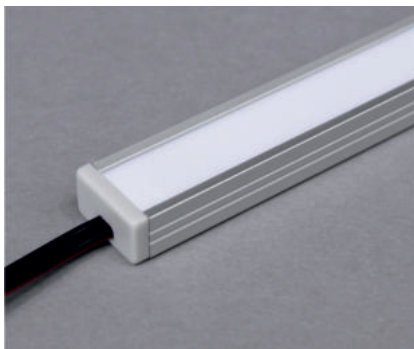

With a hole: they allow aesthetic outlet for a cable without the need to drill through the end caps or the profile.

Z otworem: pozwalają na estetyczne wyprowadzenie przewodu bez konieczności przewiercania zaślepki lub profilu.

Mit der Öffnung: ermöglichen ein ästhetisches Durchführen des Kabels ohne in der Endkappe oder in dem Profil bohren zu müssen.

Avec un trou : ils permettent au câble d'être acheminé proprement sans percer à travers un embout ou un profilé.



Without a hole: they are an aesthetic and a tighter end caps of the profile. Recommended in cases where the appearance is particularly significant, or from the opposite side to the cable outlet.

Bez otworu: stanowią estetyczne i szczelniejsze zakończenie profilu. Zalecane tam, gdzie szczególnie istotny jest wygląd lub od strony przeciwnej niż wyprowadzenie przewodu.

Ohne Öffnung: bilden eine ästhetische und dichtere Beendigung des Profils. Empfohlen dort, wo das Aussehen besonders wichtig ist oder von der gegenüberliegenden Seite zur Kabeldurchführung.

Sans trou : ils fournissent une extrémité esthétique et plus serrée du profilé.

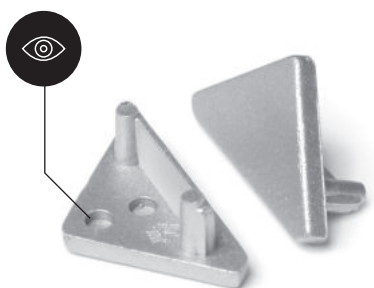

For many products, we offer end caps with points to drill a hole. Thanks to this, from one set of end caps, it is possible to obtain one end caps of each type: with a hole and without one.

Do wielu produktów oferujemy zaślepki z punktami do nawiercenia otworu. Dzięki temu z jednego kompletu zaślepek możliwe jest otrzymanie po jednej zaślepce: z otworem oraz bez otworu.

Für viele Profile bieten wir Endkappen mit Punkten für das Bohren einer Öffnung an. Mit dieser Lösung kann man aus einem Set von Endkappen jeweils eine Endkappe mit und ohne Öffnung haben.

Pour nombreux produits nous proposons les embouts avec un marquage derrière où on conseille de percer un trou. Grâce à cela il est possible d'obtenir un jeu d'embout complet : un avec trou et l'autre sans trou.

**CONNECTORS X, T 180 DEG**  
**ŁĄCZNIKI X, T 180 ST**  
**VERBINDER X, T 180 GRAD**  
**CONNECTEUR X, T 180 DEGRÉS**

**T**<sup>2</sup> → 204

connector T 180 deg  
 łącznik T 180 st  
 Verbinder T 180 Grad  
 connecteur T 180 degrés

SURFACE14 **EE7F/TY** → 44  
 LINEA20 **EE7F/TY** → 50  
 VARIO30-01 **ACDE-9/TY** → 59  
 VARIO30-02 **ACDE-9/TY** → 60  
 VARIO30-03 **ACDE-9/TY** → 63  
 GROOVE14 **EE7F/TY** → 96  
 DIAGONAL14 **F/TY** → 100  
 CORNER14 **EE7F/TY** → 130



**X**<sup>2</sup> → 207

connector X 180 deg  
 łącznik X 180 st  
 Verbinder X 180 Grad  
 connecteur X 180 degrés

SURFACE10 **BC/UX** → 40  
 GROOVE10 **BC/UX** → 92  
 DEEP10 **BC/UX** → 102  
 FLAT8 **H/UX** → 114  
 CORNER10 **BC/UX** → 126  
 BACK10 **A/UX** → 176

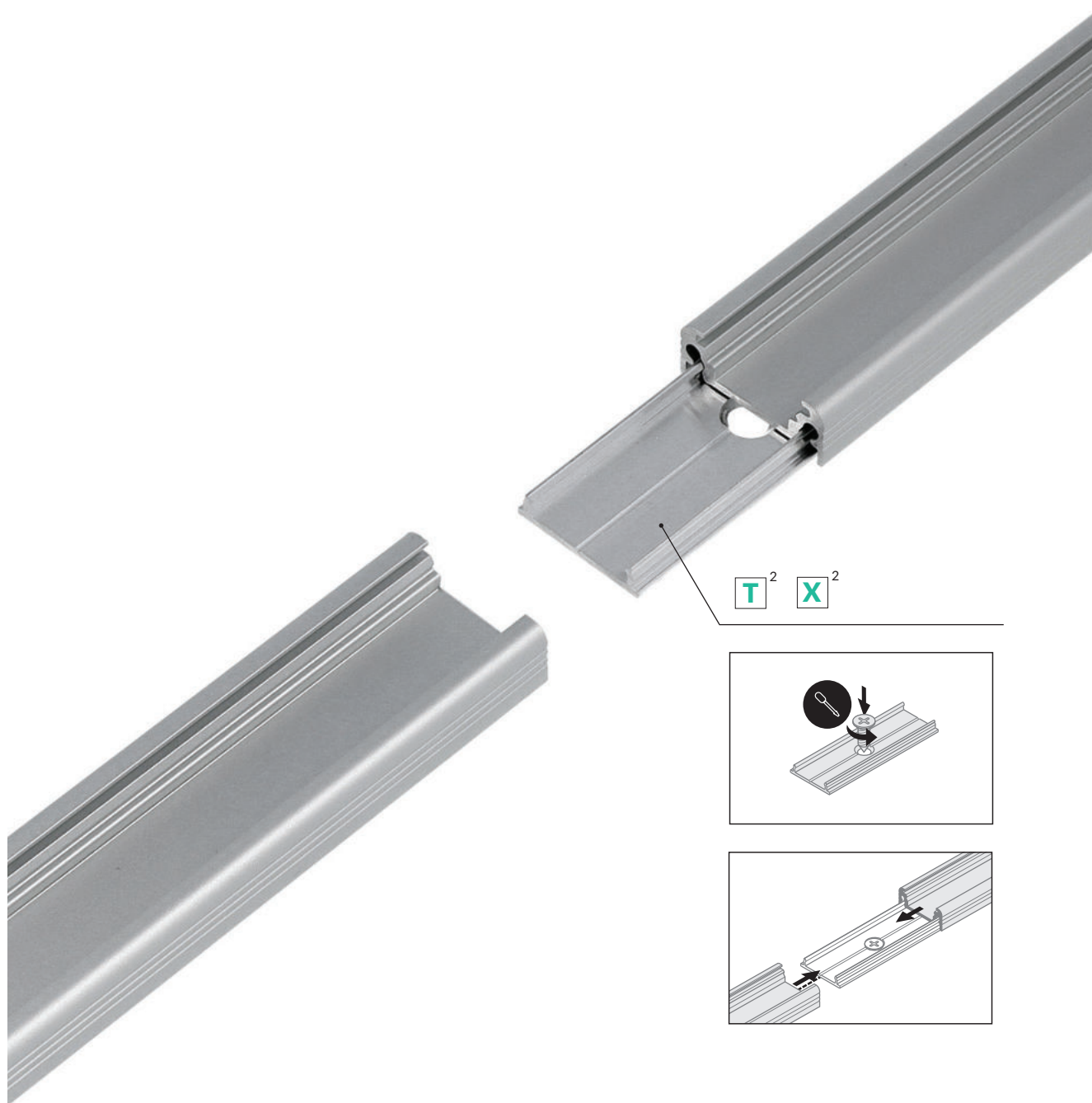

**T**<sup>2</sup> **X**<sup>2</sup>

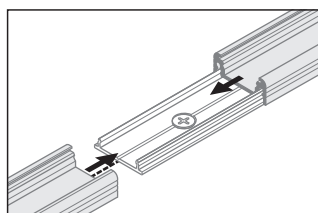
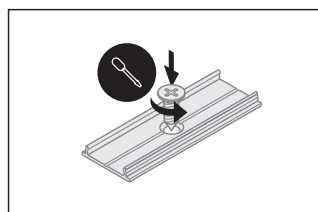



T and X connector  
may be used to make  
extra long profiles  
by connecting multiple  
profiles.

łącznik T oraz X może  
być użyty do stworzenia  
pojedynczego bardzo  
długiego profilu.

Verbinder T und X kann  
zur Fertigung eines sehr  
langen Profils benutzt  
werden.

Le connecteur T et le  
connecteur X peuvent  
être utilisés pour créer  
un seul profilé très long.

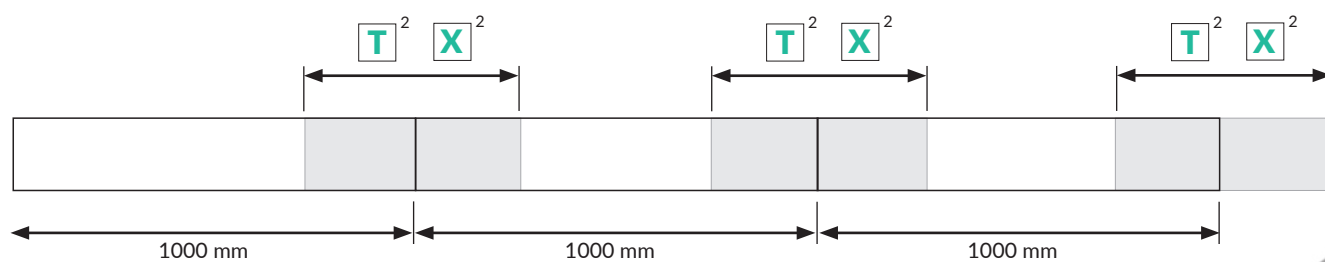

# TOLERANCE TOLERANCJA TOLERANZ TOLÉRANCE

We make every effort to maintain maximum repeatability of our products. Despite this, there may be small differences between the individual batches due to the nature of the manufacturing processes. That is why we always recommend considering the following tolerances.

Dokładamy wszelkich starań, aby utrzymać maksymalną powtarzalność naszych produktów. Mimo to pomiędzy poszczególnymi partiami występować mogą drobne różnice wynikające ze specyfiki procesów wytwarzania. Dlatego zawsze zalecamy wzięcie pod uwagę poniższych tolerancji.

Wir sind darum sehr bemüht, dass eine maximale Wiederholbarkeit unserer Produkte eingehalten wird. Trotzdem können zwischen den jeweiligen Partien geringfügige Unterschiede vorkommen, die auf die Spezifik des Herstellungsverfahrens zurückzuführen sind. Deswegen empfehlen wir immer die vorliegenden Toleranzen zu berücksichtigen.

Nous mettons tout en oeuvre pour maintenir la répétabilité maximale de nos produits. Néanmoins, il peut y avoir de légères différences entre les lots individuels en raison de la spécificité des procédés de fabrication. Par conséquent, nous vous recommandons toujours de prendre en compte les tolérances suivantes.

## LENGTH

	Standard tolerance*
PROFILES	+3 mm
CLICK DIFFUSERS: 1000 mm, 2000 mm, 3000 mm (except listed below)	+5 mm
CLICK DIFFUSERS: 2000 mm - C9, D9, E7, E9	+20 mm
CLICK DIFFUSERS: 4000 mm	+150 mm
SLIDE DIFFUSERS	+20 mm

\*It is possible to prepare product with a narrowed, special tolerance. Please ask your key account manager for details. Cutting of the products is carried out at a temperature of 20°C.

## DŁUGOŚĆ

	Standardowa tolerancja*
PROFILE	+3 mm
KLOSZE KLIK: 1000 mm, 2000 mm, 3000 mm (poza wymienionymi poniżej)	+5 mm
KLOSZE KLIK: 2000 mm - C9, D9, E7, E9	+20 mm
KLOSZE KLIK: 4000 mm	+150 mm
KLOSZE WSUWANE	+20 mm

\*Istnieje możliwość przygotowania produktu w zawężonej tolerancji specjalnej. O szczegóły zapytaj opiekuna handlowego. Cięcie produktów wykonywane jest w temperaturze 20°C.

## LÄNGE

	Standardmäßige Toleranz*
PROFILE	+3 mm
ABDECKUNG ZUM EINCLIPSSEN: 1000 mm, 2000 mm, 3000 mm (außer der unten erwähnten)	+5 mm
ABDECKUNG ZUM EINCLIPSSEN: 2000 mm - C9, D9, E7, E9	+20 mm
ABDECKUNG ZUM EINCLIPSSEN: 4000 mm	+150 mm
ABDECKUNG ZUM EINSCHIEBEN	+20 mm

\*Es gibt die Möglichkeit der Produktvorbereitung in der eingengten Spezialtoleranz. Nach den Details fragen Sie bitte Ihren Handelsbetreuer. Produkte werden bei der Temperatur von 20°C geschnitten.

## LONGUEUR

	Tolérance standard*
PROFILÉS	+3 mm
DIFFUSEURS À CLIPSER : 1000 mm, 2000 mm, 3000 mm (sauf pour ce qui suit)	+5 mm
DIFFUSEURS À CLIPSER : 2000 mm - C9, D9, E7, E9	+20 mm
DIFFUSEURS À CLIPSER : 4000 mm	+150 mm
DIFFUSEURS COULISSANTS	+20 mm

\*Attention. La préparation du produit avec une tolérance autre que la tolérance standard augmente les coûts, allonge le délai de livraison et nécessite que la tolérance souhaitée soit spécifiée lors de la commande. Les produits sont coupés à une température de 20°C.

## DIMENSIONS OF CROSS SECTION

For all provided profile dimensions we apply tolerances in accordance with PN-EN 755-9.

## DURCHMESSER

Alle angegebenen Profile unterliegen der Toleranz gemäß der Norm PN-EN 755-9.

## WYMIARY PRZEKROJÓW

Do wszystkich podawanych wymiarów profili stosowana jest tolerancja zgodnie z Normą PN-EN 755-9.

## DIMENSIONS DE LA SECTION

La tolérance selon la norme PN-EN 755-9 est appliquée à toutes les dimensions données des profilés.



COLOUR	
ANODIZED SURFACES	silver
	black
PAINTED SURFACES (according to the RAL palette)	white: RAL 9003 mat
	black: RAL 9005 mat

ATTENTION! Aluminium profiles and accessories may contain surfaces that are not visible after assembly, on which there may be acceptable process marks and for which a surface quality assessment is not applicable.

FARBE	
ELOXIERTE OBERFLÄCHEN	silbern
	schwarz
LACKIERTE OBERFLÄCHEN (anhand der RAL Palette)	weiß: RAL 9003 matt
	schwarz: RAL 9005 matt

ACHTUNG! Auf den Aluminiumprofilen und dem Zubehör können Flächen auftreten, die nach der Montage unsichtbar sind und zulässige technologische Spuren aufweisen, für welche die Bewertung der Flächenqualität nicht anzuwenden ist.

KOLOR	
POWIERZCHNIE ANODOWANE	srebrny
	czarny
POWIERZCHNIE MALOWANE (na podstawie palety RAL)	biały: RAL 9003 mat
	czarny: RAL 9005 mat

UWAGA! Profile aluminiowe i akcesoria mogą zawierać powierzchnie niewidoczne po montażu, na których mogą występować dopuszczalne ślady technologiczne i dla których ocena jakości powierzchni nie ma zastosowania.

COULEUR	
SURFACES ANODISÉES	argent
	noir
SURFACES PEINTES (basé sur la palette RAL)	blanc: RAL 9003 mat
	noir: RAL 9005 mat

ATTENTION ! Certaines surfaces de profilés en aluminium et d'accessoires peuvent être invisibles et contenir des traces de fabrication acceptables auxquelles l'évaluation de la qualité de surface ne s'applique pas.

### AVAILABLE LENGTHS

Aluminium profiles:  
1000 mm, 2000 mm, 3000 mm, 4050 mm

Click diffusers:  
1000 mm, 2000 mm, 3000 mm, 4000 / 4050 / 4100 mm

Slide diffusers, opal and transparent:  
1000 mm, 2000 mm

Slide diffusers, frosted:  
1000 mm, 2000 mm, 3000 mm

C, C2, F diffusers:  
reel 20 000 mm (20 m)

### VERFÜGBARE LÄNGEN

Aluprofil:  
1000 mm, 2000 mm, 3000 mm, 4050 mm

Abdeckungen einclipbar:  
1000 mm, 2000 mm, 3000 mm, 4000 / 4050 / 4100 mm

Abdeckungen einschiebbar, opal und transparent:  
1000 mm, 2000 mm

Abdeckungen einschiebbar, satiniert:  
1000 mm, 2000 mm, 3000 mm

C, C2, F Abdeckungen:  
Rolle 20 000 mm (20 m)

### DOSTĘPNE DŁUGOŚCI

Profile aluminiowe:  
1000 mm, 2000 mm, 3000 mm, 4050 mm

Klosze klik:  
1000 mm, 2000 mm, 3000 mm, 4000 / 4050 / 4100 mm

klosze wsuwane mleczne i transparentne:  
1000 mm, 2000 mm

Klosze wsuwane szron:  
1000 mm, 2000 mm, 3000 mm

klosze C, C2, F:  
rolki 20 000 mm (20 m)

### LONGUEURS DISPONIBLES

Profilés en aluminium :  
1000 mm, 2000 mm, 3000 mm, 4050 mm

Diffuseurs à clipser :  
1000 mm, 2000 mm, 3000 mm, 4000 / 4050 / 4100 mm

Diffuseurs coulissants opaque et transparent :  
1000 mm, 2000 mm

Diffuseurs coulissants givré :  
1000 mm, 2000 mm, 3000 mm

Diffuseurs C, C2, F:  
rouleau 20 000 mm (20 m)

### WARRANTY

Standard TOPMET products warranty = 12 months.

### GARANTIE

Standardgarantie für TOPMET-Produkte = 12 Monate.

### GWARANCJA

Standardowa gwarancja na produkty TOPMET = 12 miesięcy.

### GARANTIE

Garantie standard pour les produits TOPMET = 12 mois.

# PAINTING SERVICE USŁUGA MALOWANIA DIENSTLEISTUNG DES ANSTREICHENS SERVICE DE PEINTURE

From now, you can order selected TOPMET Light products in one of the 2530 RAL colours.

The RAL chart features also metallic colours, including gold.

Ask your Account Manager about the minimum purchase and technical details.

Od teraz wybrane produkty topmet zamówisz w jednym z 2530 kolorów palety RAL.

Paleta RAL zawiera również kolory metaliczne - w tym złoty.

O minima zakupowe i szczegóły techniczne - zapytaj swojego Opiekuna Klienta.

Ab jetzt gewählte TOPMET Produkte bestellen Sie in beliebiger Farbe aus 2530 Farben der RAL Palette.

RAL Palette beinhaltet auch metallische Farben - darunter golden.

Nach MOQ und den technischen Details fragen Sie Ihren Kundenbetreuer.

Désormais certains produits haut de gamme, vous pouvez commander dans n'importe quelle couleur à partir de 2530 couleurs de la palette RAL.

La palette RAL comprend également des couleurs métalliques - y compris l'or. Pour connaître MOQ exigée ou des détails techniques - merci de contacter notre Service Client.

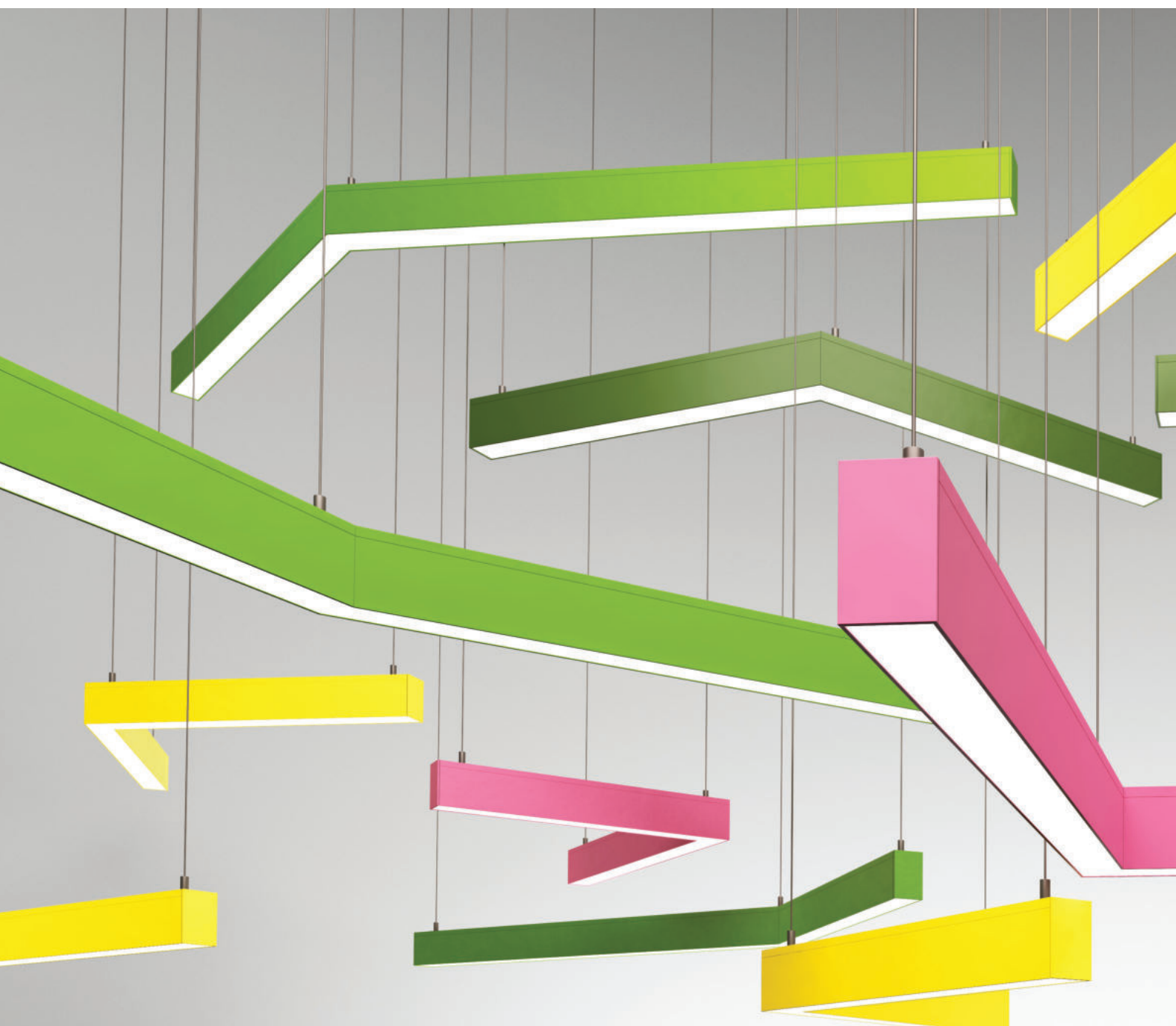

Profile & end cap in the same colour  
Ten sam kolor profilu i zaślepki  
Gleiche Farbe des Profils und der Endkappe  
Même profilé et même couleur de embout



Quality and repeatability  
Jakość i powtarzalność barwy  
Farbqualität und Wiederholbarkeit  
Qualité et répétabilité des couleurs

Metalic paint  
including golden

Kolory metaliczne  
w tym złoty

Metallische Farben  
einschließlich Gold

Couleurs métalliques,  
y compris l'or



# ECOLOGY EKOLOGIA ÖKOLOGIE ÉCOLOGIE

What we should pay particular attention to is the impact of everyday use devices on the natural environment. And so, lights using the LED technology are biodegradable, have a longer lifespan compared to traditional sources and consume less energy. Moreover, LED does not contain mercury.

less source replacements = less waste reaching the environment

To, na co powinniśmy zwrócić największą uwagę, to oddziaływanie na środowisko naturalne urządzeń codziennego użytku. I tak światła wykorzystujące technologię LED są biodegradowalne, mają większą żywotność w stosunku do tradycyjnych źródeł oraz zużywają mniej energii. Ponadto LED nie zawiera rtęci.

mniej wymian źródeł = mniej odpadów trafiających do środowiska

Das, worauf wir besonders unsere Aufmerksamkeit lenken sollen, ist die Auswirkung der Alltagsgeräte auf unsere natürliche Umwelt. Die Leuchten mit LED Technologie sind biologisch abbaubar, haben eine längere Lebensdauer im Vergleich zu traditionellen Lichtquellen und verbrauchen weniger Energie. Überdies beinhalten LEDs kein Quecksilber.

Weniger Austausch von Lichtquellen = weniger Abfall in unserer Umwelt

Ce à quoi nous devons prêter le plus d'attention, c'est l'impact environnemental des appareils de tous les jours. Ainsi, les lampes utilisant la technologie LED sont biodégradables, ont une durée de vie plus longue que les sources traditionnelles et consomment moins d'énergie. De plus, la LED ne contient pas de mercure.

moins d'échanges de sources = moins de déchets destinés à l'environnement















**SURFACE, SUSPENDED  
NAWIERZCHNIOWE, ZWIESZANE  
AUFBAUPROFILLE, AUSGESETZT  
SURFACE, SUSPENSION**





max 8 mm

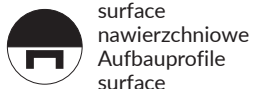

surface  
nawierzchniowe  
Aufbauprofile  
surface



furniture  
meblowe  
Möbel-  
mobilier

- universal application
- Slick socket
- 2 channels for mounting plates (with or without wall distance)
- painted mounting plates

- uniwersalne zastosowanie
- gniazdo Slick
- 2 rowki - 2 poziomy przymocowania uchwytu (z dystansem od ściany lub bez)
- malowane uchwyty

- universelle Anwendung
- Sockel mit Slick Funktion
- zwei Rillen - zwei Niveaus der Befestigung des Halters (mit einem Abstand oder ohne Abstand von der Wand)
- gemalte Halter

- usage universel
- prise Slick
- 2 rainures - 2 niveaux de montage de la fixation (avec ou sans distance du mur)



more  
information



więcej  
szczegółów

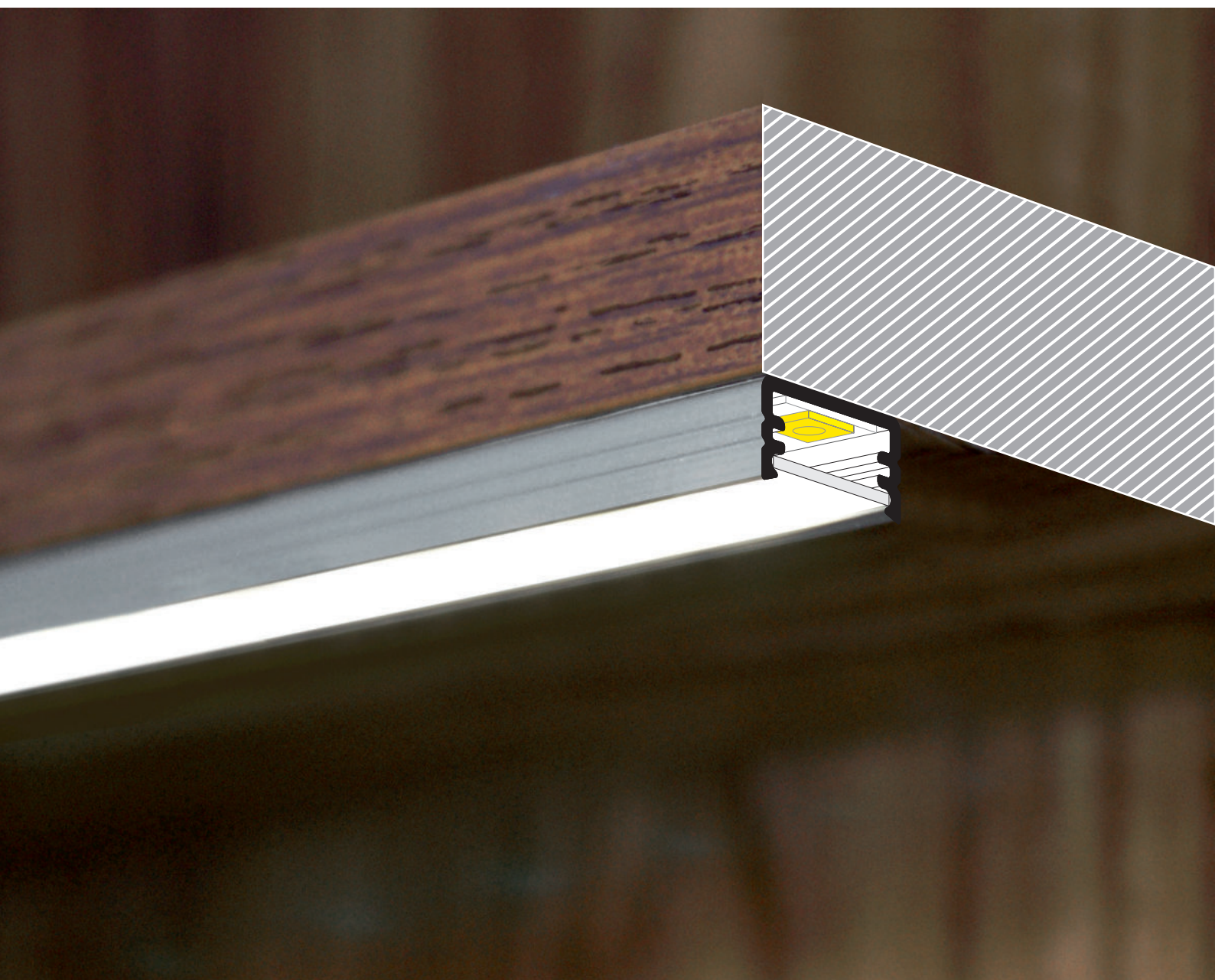



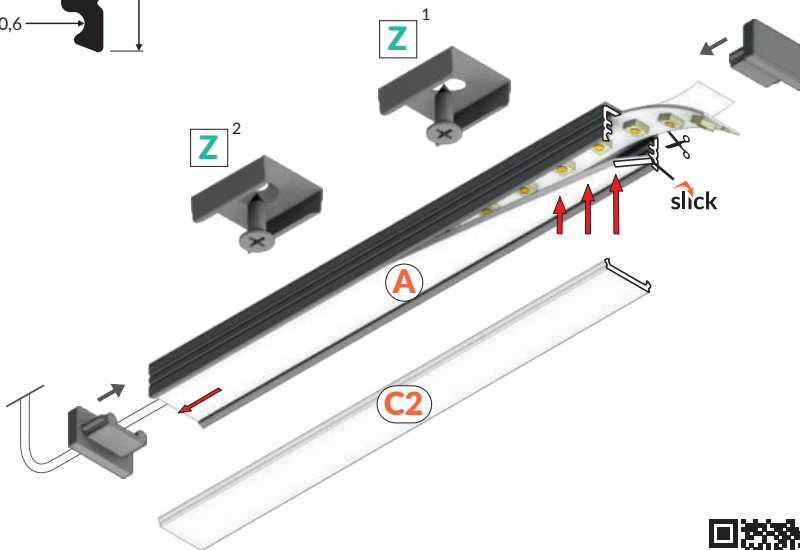
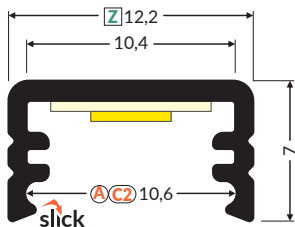

Technical manual  
Instrukcja techniczna  
Technische Anleitung  
Manuel technique



**Z<sup>1</sup>** → 208

mounting plate Z  
uchwyt Z  
Halter Z  
fixation Z

**Z<sup>2</sup>** → 208

mounting plate Z cone  
uchwyt Z cone  
Halter Z cone  
fixation Z cône

**A** → 194

diffuser A slide  
klosz A wsuwany  
Abdeckung A einschiebbar  
diffuseur A coulissant

**C2** → 196

diffuser C2 click  
klosz C2 klik  
Abdeckung C2 einclipsbar  
diffuseur C2 clic

white painted biały malowany weiß lackiert peint en blanc	anodized anodowany eloxiert surface anodisée	black anodized czarny anodowany schwarz eloxiert noir anodisé	raw aluminium surowe aluminium Rohaluminium aluminium brut
1000 mm <b>89020001</b>	<b>89020020</b>	<b>89020021</b>	<b>89020000</b>
2000 mm <b>89030001</b>	<b>89030020</b>	<b>89030021</b>	<b>89030000</b>
3000 mm <b>89190001</b>	<b>89190020</b>	<b>89190021</b>	<b>89190000</b>
4050 mm <b>89200001</b>	<b>89200020</b>	<b>89200021</b>	<b>89200000</b>

end cap SLIM8  
zaślepka SLIM8  
Endkappe SLIM8  
embout SLIM8



white biały weiß blanc	silver srebrny silbern argent
<b>89080001</b>	<b>89080040</b>

black czarny schwarz noir	grey szary grau gris
<b>89080002</b>	<b>89080022</b>

end cap SLIM8 with hole  
zaślepka SLIM8 z otworem  
Endkappe SLIM8 mit Öffnung  
embout SLIM8 avec un trou



white biały weiß blanc	silver srebrny silbern argent
<b>89140001</b>	<b>89140040</b>

black czarny schwarz noir	grey szary grau gris
<b>89140002</b>	<b>89140022</b>

connector SLIM8 90 deg  
łącznik SLIM8 90 st  
Verbinder SLIM8 90 Grad  
connecteur SLIM8 90 degrés

material: aluminium  
materiał: aluminium  
Material: Aluminium  
matériel: aluminium

white painted  
biały malowany  
weiß lackiert  
peint en blanc

**89150001**

anodized  
anodowany  
eloxiert  
surface anodisée

**89150020**

black anodized  
czarny anodowany  
schwarz eloxiert  
noir anodisé

**89150021**

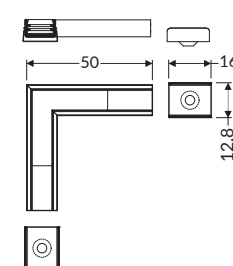

holder SLIM8 simple  
uchwyt SLIM8 prosty  
Halter SLIM8 einfach  
fixation SLIM8 simple

material: zinc coated steel  
materiał: stal ocynkowana  
Material: Verzinkter Stahl  
matériel: acier galvanisé

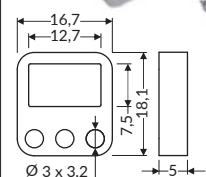

zinc coated steel  
stal ocynkowana  
verzinkter Stahl  
acier galvanisé

**89110030**



max 10 mm



surface  
nawierzchniowe  
Aufbauprofile  
surface



furniture  
meblowe  
Möbel-  
mobilier

- continuous line of light (when using LED strip 120 P/m and opal diffuser)
- Slick socket
- miniature dimensions
- universal application
- the possibility of using waterproof LED strips

- ciągła linia światła (przy zastosowaniu taśmy 120 P/m i klosza mlecznego)
- gniazdo Slick
- miniaturowe gabaryty
- uniwersalne zastosowanie
- możliwość zastosowania taśm wodoodpornych

- eine homogene Lichtlinie (unter Verwendung von LED Streifen mit 120 leds/m und einer opalen Abdeckung)
- Sockel mit Slick Funktion
- kleine Maße
- universelle Anwendung
- Möglichkeit der Anwendung von wasserdichten Streifen

- une ligne continue de lumière (en utilisant un ruban 120 P/m et un diffuseur opaque)
- prise avec fonction Slick-dimensions miniatures
- usage universel
- possibilité d'utilisation du ruban LED étanche



more  
information



więcej  
szczegółów

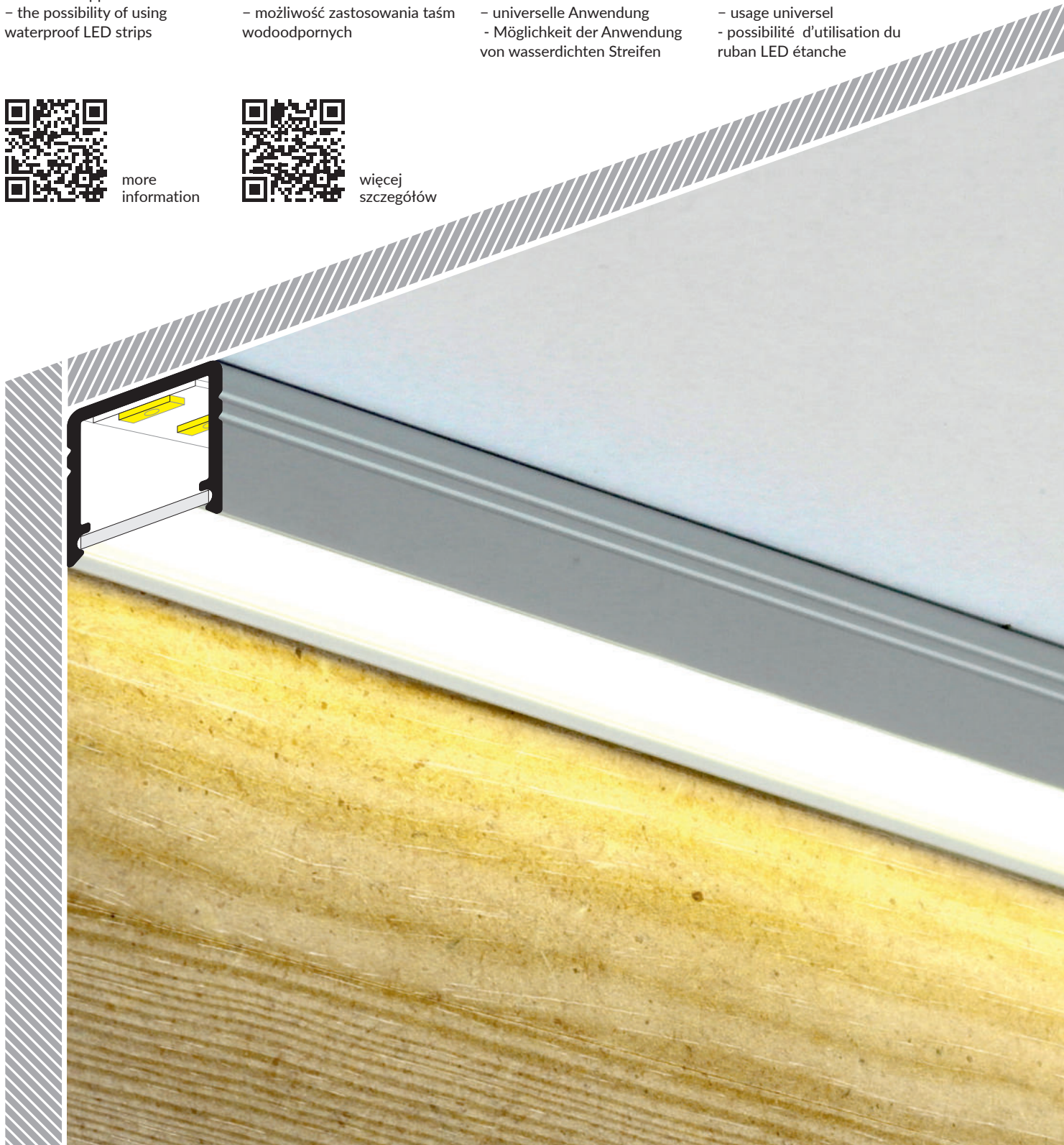

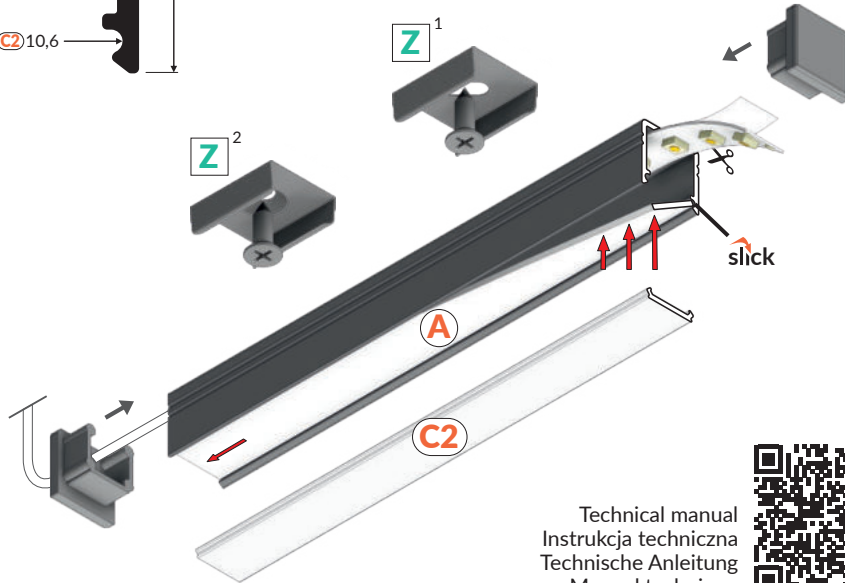
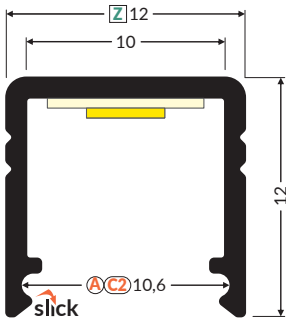

Technical manual  
Instrukcja techniczna  
Technische Anleitung  
Manuel technique

**Z**<sup>1</sup> → 208

mounting plate Z  
uchwyt Z  
Halter Z  
fixation Z

**Z**<sup>2</sup> → 208

mounting plate Z cone  
uchwyt Z cone  
Halter Z cone  
fixation Z cône

**A** → 194

diffuser A slide  
klosz A wsuwany  
Abdeckung A einschiebbar  
diffuseur A coulissant

**C2** → 196

diffuser C2 click  
klosz C2 klik  
Abdeckung C2 einclipsbar  
diffuseur C2 clic

white painted biały malowany weiß lackiert peint en blanc	anodized anodowany eloxiert surface anodisée	black anodized czarny anodowany schwarz eloxiert noir anodisé	raw aluminium surowe aluminium Rohaluminium aluminium brut
1000 mm <b>C2010001</b>	<b>C2010020</b>	<b>C2010021</b>	<b>C2010000</b>
2000 mm <b>C2020001</b>	<b>C2020020</b>	<b>C2020021</b>	<b>C2020000</b>
3000 mm <b>C2030001</b>	<b>C2030020</b>	<b>C2030021</b>	<b>C20</b>
4050 mm <b>C2040001</b>	<b>C2040020</b>	<b>C2040021</b>	

end cap SMART10  
zaślepka SMART10  
Endkappe SMART10  
embout SMART10



white biały weiß blanc	silver srebrny silbern argent
<b>C2940001</b>	<b>C2940040</b>

black czarny schwarz noir	grey szary grau gris
<b>C2940002</b>	<b>C2940022</b>

end cap SMART10 with hole  
zaślepka SMART10 z otworem  
Endkappe SMART10 mit Öffnung  
embout SMART10 avec un trou



white biały weiß blanc	silver srebrny silbern argent
<b>C2960001</b>	<b>C2960040</b>

black czarny schwarz noir	grey szary grau gris
<b>C2960002</b>	<b>C2960022</b>

connector SMART10 90 deg  
łącznik SMART10 90 st  
Verbinder SMART10 90 Grad  
connecteur SMART10 90 degrés

material: aluminium  
materiał: aluminium  
Material: Aluminium  
matériel: aluminium

white painted  
biały malowany  
weiß lackiert  
peint en blanc  
**C2910001**

anodized  
anodowany  
eloxiert  
surface anodisée  
**C2910020**

black anodized  
czarny anodowany  
schwarz eloxiert  
noir anodisé  
**C2910021**

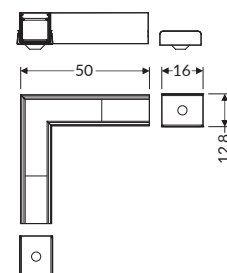



# BEGTON12 J/S



max 12 mm



surface  
nawierzchniowe  
Aufbauprofile  
surface



furniture  
meblowe  
Möbel-  
mobilier

- light weight, budget profile  
- Slick socket

- lekki profil budżetowy  
- gniazdo z funkcją Slick

- ein leichtes Budget-Profil  
- Sockel mit Slick Funktion

- profilé léger à prix bas  
- prise avec fonction Slick



more  
information



więcej  
szczegółów



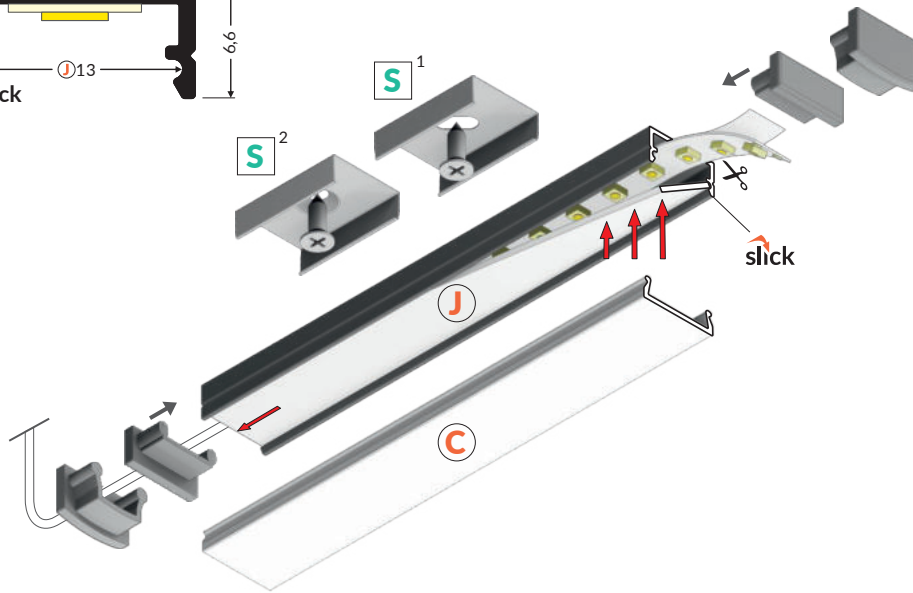
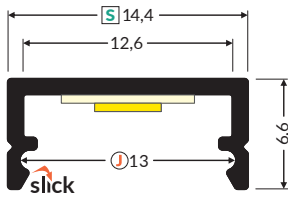

Technical manual  
Instrukcja techniczna  
Technische Anleitung  
Manuel technique



**S**<sup>1</sup> → 204

mounting plate S  
uchwyt S  
Halter S  
fixation S

**S**<sup>2</sup> → 204

mounting plate S cone  
uchwyt S cone  
Halter S cone  
fixation S cône

**J** → 200

diffuser J slide  
klosz J wsuwany  
Abdeckung J einschiebbar  
diffuseur J coulissant

**C** → 195

diffuser C click  
klosz C klik  
Abdeckung C einclipsbar  
diffuseur C clic



white painted  
biały malowany  
weiß lackiert  
peint en blanc



anodized  
anodowany  
eloxiert  
surface anodisée



black anodized  
czarny anodowany  
schwarz eloxiert  
noir anodisé



raw aluminium  
surowe aluminium  
Rohaluminium  
aluminium brut

1000 mm	<b>C7010001</b>	<b>C7010020</b>	<b>C7010021</b>	<b>C7010000</b>
2000 mm	<b>C7020001</b>	<b>C7020020</b>	<b>C7020021</b>	<b>C7020000</b>
3000 mm	<b>C7030001</b>	<b>C7030020</b>	<b>C7030021</b>	<b>C7030000</b>
4050 mm	<b>C7040001</b>	<b>C7040020</b>	<b>C7040021</b>	<b>C7040000</b>

end cap BEGTON12  
zaślepka BEGTON12  
Endkappe BEGTON12  
embout BEGTON12



white  
biały  
weiß  
blanc

**C7960001**

silver  
srebrny  
silbern  
argent

**C7960040**

black  
czarny  
schwarz  
noir

**C7960002**

grey  
szary  
grau  
gris

**C7960022**

end cap BEGTON12 C  
zaślepka BEGTON12 C  
Endkappe BEGTON12 C  
embout BEGTON12 C



white  
biały  
weiß  
blanc

**C7940001**

silver  
srebrny  
silbern  
argent

**C7940040**

black  
czarny  
schwarz  
noir

**C7940002**

grey  
szary  
grau  
gris

**C7940022**

# UNI12 BCD/U



max 12 mm



surface  
nawierzchniowe  
Aufbauprofile  
surface



furniture  
meblowe  
Möbel-  
mobilier

- 8 diffusers to choose from  
- increased radiation -  
it is possible to use  
a stronger LED strip

- 8 kloszy do wyboru  
- zwiększona radiacja -  
możliwość zastosowania  
mocniejszej taśmy LED

- 8 Abdeckungen zur Wahl  
- erhöhte Radiation -  
die Möglichkeit der  
Anwendung eines stärkeren  
LED Streifens

- 8 diffuseurs au choix  
- dissipation thermique accrue -  
possibilité d'utiliser un ruban LED  
plus puissant



more  
information



więcej  
szczegółów

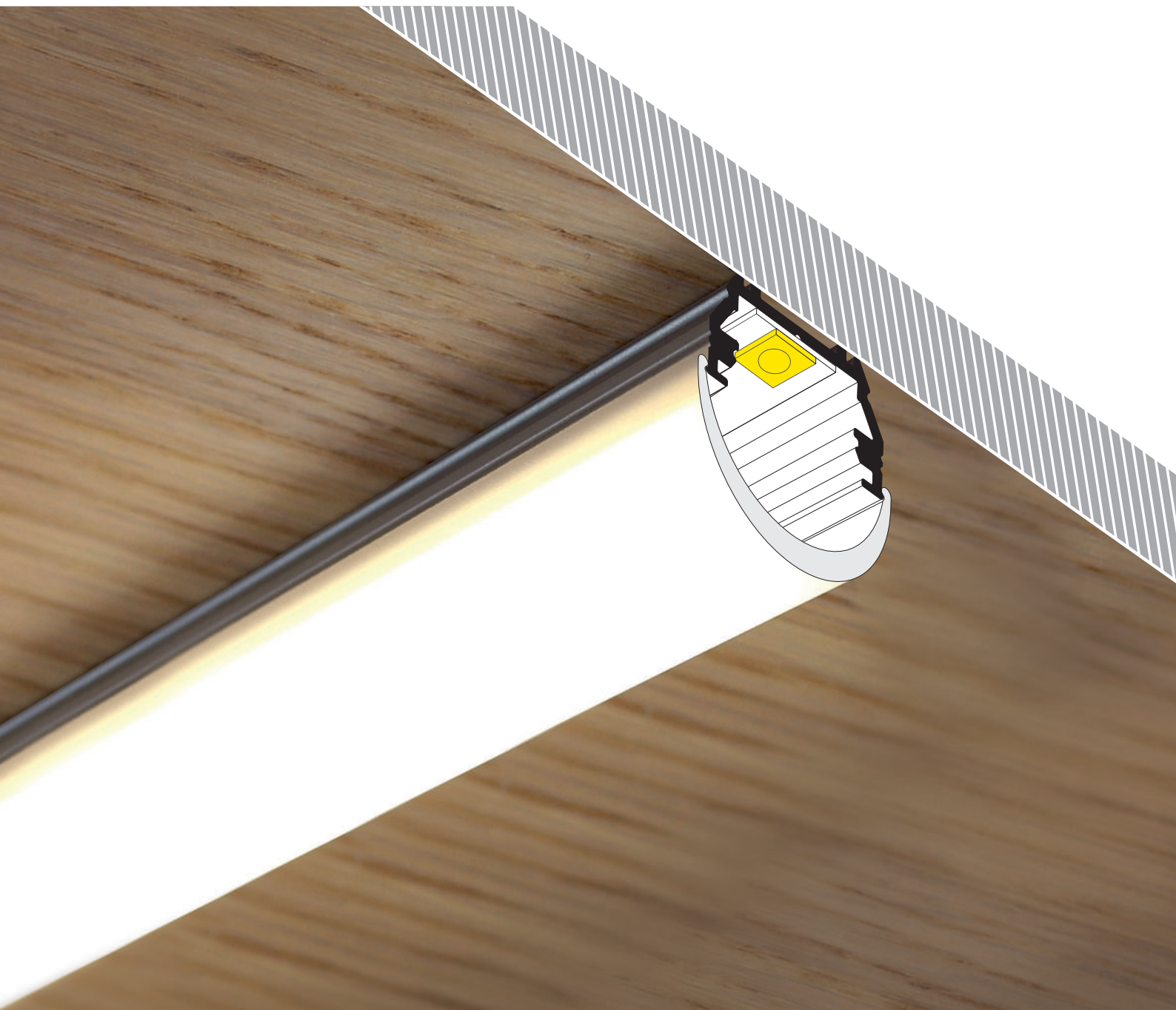



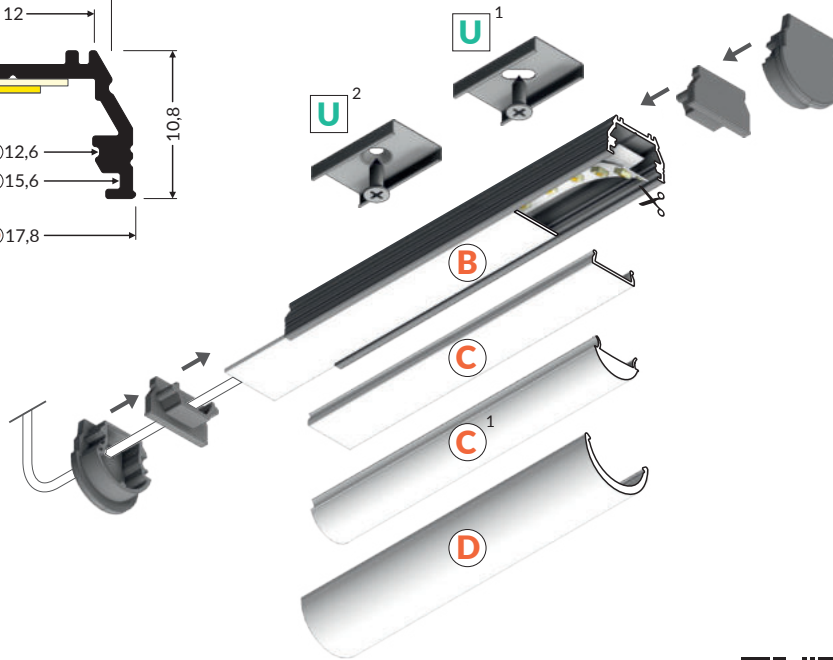
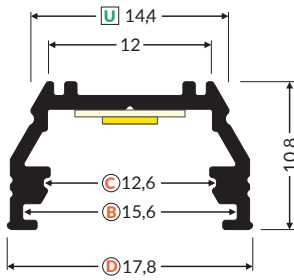

Technical manual  
Instrukcja techniczna  
Technische Anleitung  
Manuel technique



**U**<sup>1</sup> → 204

mounting plate U  
uchwyt U  
Halter U  
fixation U

**U**<sup>2</sup> → 204

mounting plate U cone  
uchwyt U cone  
Halter U cone  
fixation U cône

**B** → 194

diffuser B slide  
klosz B wsuwany  
Abdeckung B einschiebbar  
diffuseur B coulissant

**C** → 195

diffuser C click  
klosz C klik  
Abdeckung C einclipsbar  
diffuseur C clic

**C**<sup>1</sup> → 195

diffuser C click lens gen2  
klosz C klik soczewka gen2  
Abdeckung C einclipsbar  
Linse gen2  
diffuseur C clic lentille gen 2

**D** → 198

diffuser D click  
klosz D klik  
Abdeckung D einclipsbar  
diffuseur D clic



white painted  
biały malowany  
weiß lackiert  
peint en blanc



anodized  
anodowany  
eloxiert  
surface anodisée



black anodized  
czarny anodowany  
schwarz eloxiert  
noir anodisé



raw aluminium  
surowe aluminium  
Rohaluminium  
aluminium brut

1000 mm	<b>A1010001</b>	<b>A1010020</b>	<b>A1010021</b>	<b>A1010000</b>
2000 mm	<b>A1020001</b>	<b>A1020020</b>	<b>A1020021</b>	<b>A1020000</b>
3000 mm	<b>A1170001</b>	<b>A1170020</b>	<b>A1170021</b>	<b>A1170000</b>
4050 mm	<b>A1110001</b>	<b>A1110020</b>	<b>A1110021</b>	<b>A1110000</b>

connector UNI12 90 deg  
łącznik UNI12 90 st  
Verbinder UNI12 90 Grad  
connecteur UNI12 90 degrés

material: aluminium  
material: aluminium  
Material: Aluminium  
matériel: aluminium

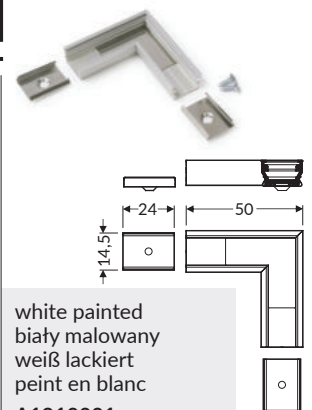

white painted  
biały malowany  
weiß lackiert  
peint en blanc  
**A1910001**

anodized  
anodowany  
eloxiert  
surface anodisée  
**A1910020**

black anodized  
czarny anodowany  
schwarz eloxiert  
noir anodisé  
**A1910021**

end cap UNI12 gen2  
zaślepka UNI12 gen2  
Endkappe UNI12 gen2  
embout UNI12 gen2

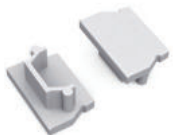

white  
biały  
weiß  
blanc  
**A1900001**

silver  
srebrny  
silbern  
argent  
**A1900040**

black  
czarny  
schwarz  
noir  
**A1900002**

grey  
szary  
grau  
gris  
**A1900022**

end cap UNI12 gen2  
with hole  
zaślepka UNI12 gen2  
z otworem  
Endkappe UNI12 gen2  
mit Öffnung  
embout UNI12 gen2  
avec un trou



white  
biały  
weiß  
blanc  
**A1890001**

silver  
srebrny  
silbern  
argent  
**A1890040**

black  
czarny  
schwarz  
noir  
**A1890002**

grey  
szary  
grau  
gris  
**A1890022**

end cap UNI12 D  
zaślepka UNI12 D  
Endkappe UNI12 D  
embout UNI12 D



white  
biały  
weiß  
blanc  
**A1940001**

silver  
srebrny  
silbern  
argent  
**A1940040**

black  
czarny  
schwarz  
noir  
**A1940002**

grey  
szary  
grau  
gris  
**A1940022**

end cap UNI12 D  
with hole  
zaślepka UNI12 D  
z otworem  
Endkappe UNI12 D  
mit Öffnung  
embout UNI12 D  
avec un trou



white  
biały  
weiß  
blanc  
**A1960001**

silver  
srebrny  
silbern  
argent  
**A1960040**

black  
czarny  
schwarz  
noir  
**A1960002**

grey  
szary  
grau  
gris  
**A1960022**



# SURFACE10 BC/UX



max 10 mm



surface  
nawierzchniowe  
Aufbauprofile  
surface



furniture  
meblowe  
Möbel-  
mobilier

- hidden mounting  
- wide range of accessories,  
7 types of diffusers

- ukryte mocowanie  
- szeroka oferta akcesoriów,  
7 typów kloszy

- eine versteckte Befestigung  
- eine breite Zubehörwahl,  
7 Arten der Abdeckungen

- fixation cachée  
- large gamme d'accessoires,  
7 types des diffuseurs



more  
information



więcej  
szczegółów

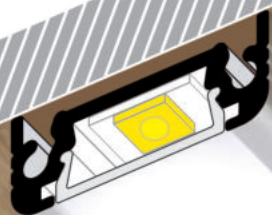

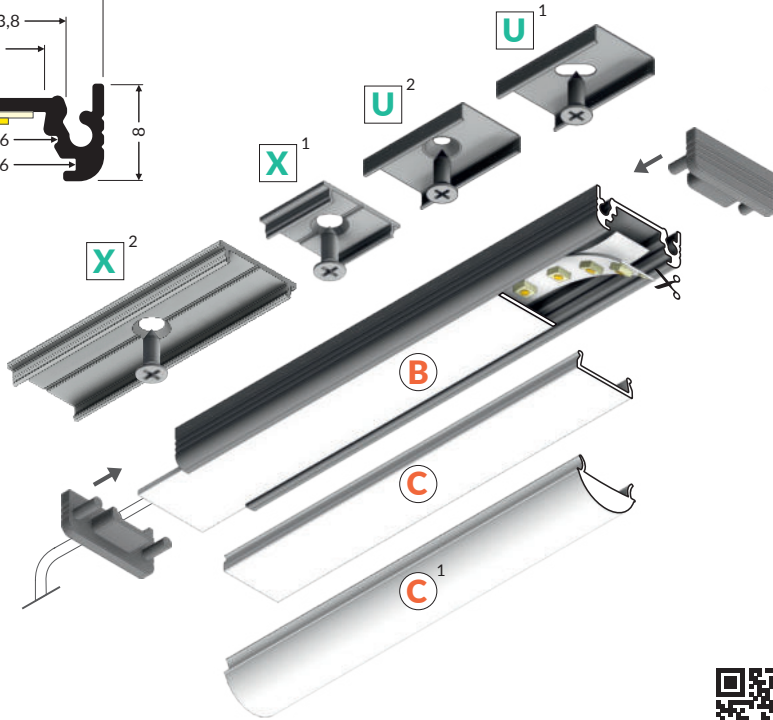
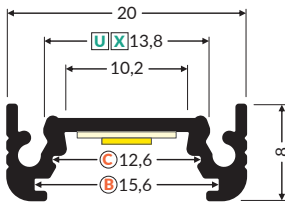

Technical manual  
Instrukcja techniczna  
Technische Anleitung  
Manuel technique



**U**<sup>1</sup> → 204

mounting plate U  
uchwyt U  
Halter U  
fixation U

**U**<sup>2</sup> → 204

mounting plate U cone  
uchwyt U cone  
Halter U cone  
fixation U cône

**X**<sup>1</sup> → 207

mounting plate X  
uchwyt X  
Halter X  
fixation X

**X**<sup>2</sup> → 207

connector X 180 deg  
łącznik X 180 st  
Verbinder X 180 Grad  
connecteur X 180 degrés

**B** → 194

diffuser B slide  
klosz B wsuwany  
Abdeckung B einschiebbar  
diffuseur B coulissant

**C** → 195

diffuser C click  
klosz C klik  
Abdeckung C einclipsbar  
diffuseur C clic

**C**<sup>1</sup> → 195

diffuser C click lens gen2  
klosz C klik soczewka gen2  
Abdeckung C einclipsbar  
Linse gen2  
diffuseur C clic lentille gen 2



white painted  
biały malowany  
weiß lackiert  
peint en blanc



anodized  
anodowany  
eloxiert  
surface anodisée



black anodized  
czarny anodowany  
schwarz eloxiert  
noir anodisé



raw aluminium  
surowe aluminium  
Rohaluminium  
aluminium brut

1000 mm	77260001	77260020	77260021	77260000
2000 mm	77270001	77270020	77270021	77270000
3000 mm	77560001	77570020	77570021	77570000
4050 mm	77580001	77580020	77580021	77580000

end cap SURFACE10 gen2  
zaślepka SURFACE10 gen2  
Endkappe SURFACE10 gen2  
embout SURFACE10 gen2



white biały weiß blanc	silver srebrny silbern argent
<b>77990001</b>	<b>77990040</b>

black czarny schwarz noir	grey szary grau gris
<b>77990002</b>	<b>77990022</b>

end cap SURFACE10 gen2 with hole  
zaślepka SURFACE10 gen2 z otworem  
Endkappe SURFACE10 gen2 mit Öffnung  
embout SURFACE10 gen2 avec un trou



white biały weiß blanc	silver srebrny silbern argent
<b>77980001</b>	<b>77980040</b>

black czarny schwarz noir	grey szary grau gris
<b>77980002</b>	<b>77980022</b>

connector SURFACE10 90 deg  
łącznik SURFACE10 90 st  
Verbinder SURFACE10 90 Grad  
connecteur SURFACE10 90 degrés

material: aluminium  
materiał: aluminium  
Material: Aluminium  
matériel: aluminium

white painted  
biały malowany  
weiß lackiert  
peint en blanc  
**77410001**

anodized  
anodowany  
eloxiert  
surface anodisée  
**77410020**

black anodized  
czarny anodowany  
schwarz eloxiert  
noir anodisé  
**77410021**

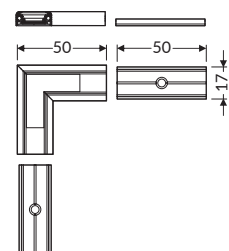

# SURFACE10.v2 BC/U



max 10 mm



surface  
nawierzchniowe  
Aufbauprofile  
surface



furniture  
meblowe  
Möbel-  
mobilier

- a new generation of surface profiles
- basic and aesthetically pleasing furniture profile
- concealed fixing
- reduced weight
- updated design

- nowa generacja profili nawierzchniowych
- podstawowy i estetyczny profil meblowy
- ukryte mocowanie
- zredukowana waga
- odświeżony design

- neue Generation von Abdeckprofilen
- einfaches und ästhetisches Möbelprofil
- versteckte Verankerung
- reduziertes Gewicht
- aufgefrishtes Design

- nouvelle génération des profilés de surface
- profilé de mobilier basique et esthétique
- fixation cachée
- poids réduit
- design rafraîchi



more  
information



więcej  
szczegółów

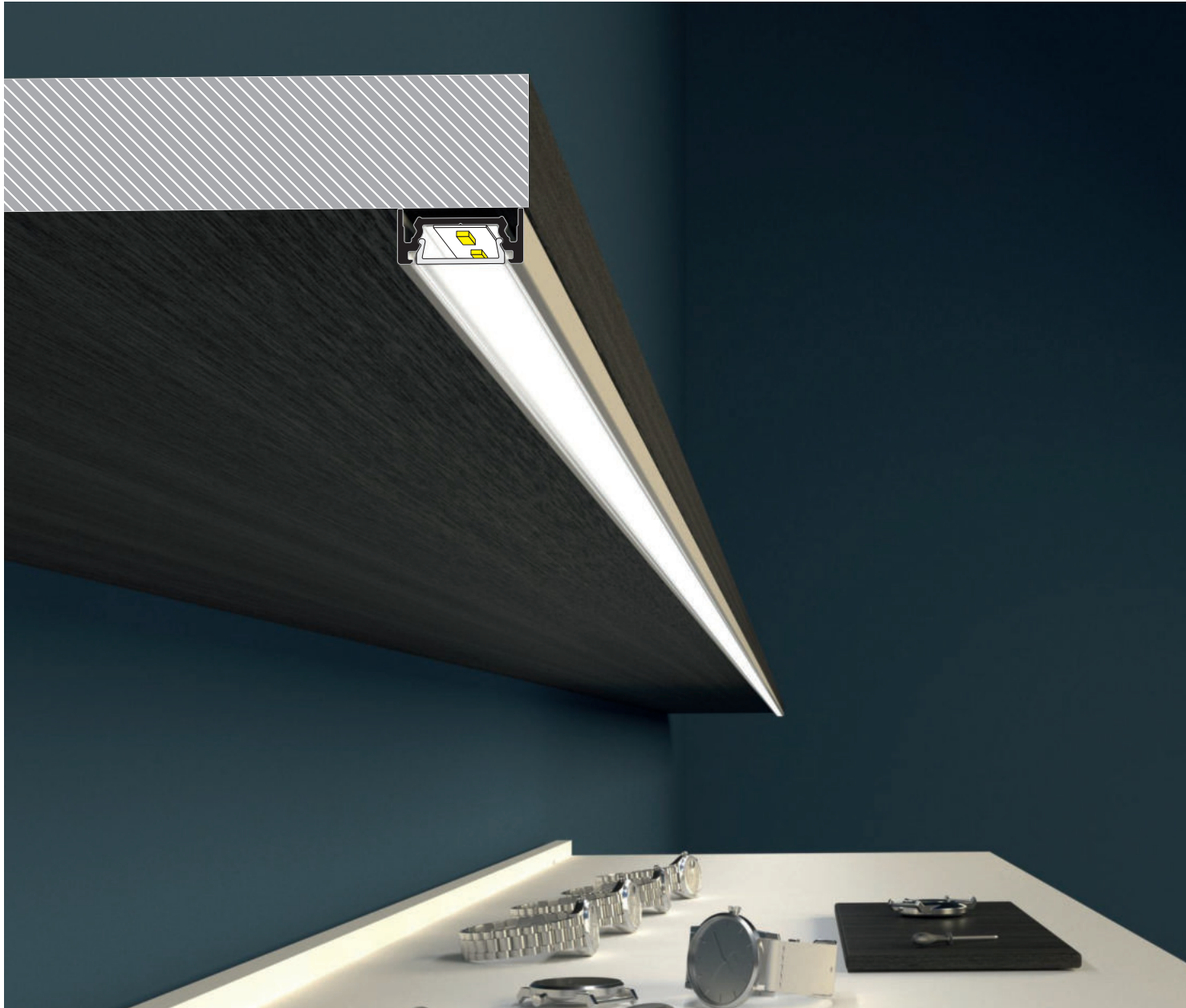



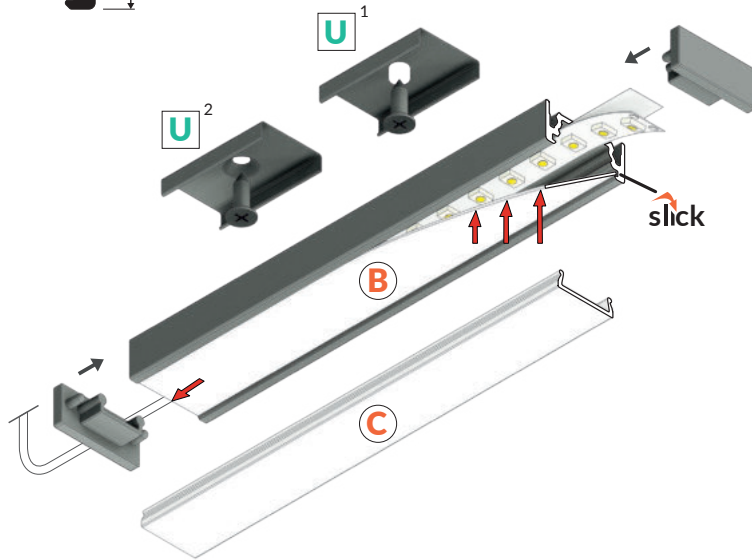
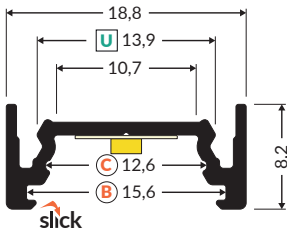

**U**<sup>1</sup> → 204

mounting plate U  
uchwyt U  
Halter U  
fixation U

**U**<sup>2</sup> → 204

mounting plate U cone  
uchwyt U cone  
Halter U cone  
fixation U cône

**B** → 194

diffuser B slide  
klosz B wsuwany  
Abdeckung B einschiebbar  
diffuseur B coulissant

**C** → 195

diffuser C klik  
klosz C klik  
Abdeckung C einclipsbar  
diffuseur C clic



white painted  
biały malowany  
weiß lackiert  
peint en blanc



anodized  
anodowany  
eloxiert  
surface anodisée



black anodized  
czarny anodowany  
schwarz eloxiert  
noir anodisé



raw aluminium  
surowe aluminium  
Rohaluminium  
aluminium brut

1000 mm	K3000101	K3000120	K3000121	K3000100
2000 mm	K3000201	K3000220	K3000221	K3000200
3000 mm	K3000301	K3000320	K3000321	K3000300
4050 mm	K3000401	K3000420	K3000421	K3000400

end cap SURFACE10.v2  
zaślepka SURFACE10.v2  
Endkappe SURFACE10.v2  
embout SURFACE10.v2

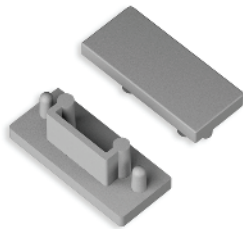

white  
biały  
weiß  
blanc  
K3999901

silver  
srebrny  
silbern  
argent  
K3999940

black  
czarny  
schwarz  
noir  
K3999902

grey  
szary  
grau  
gris  
K3999922

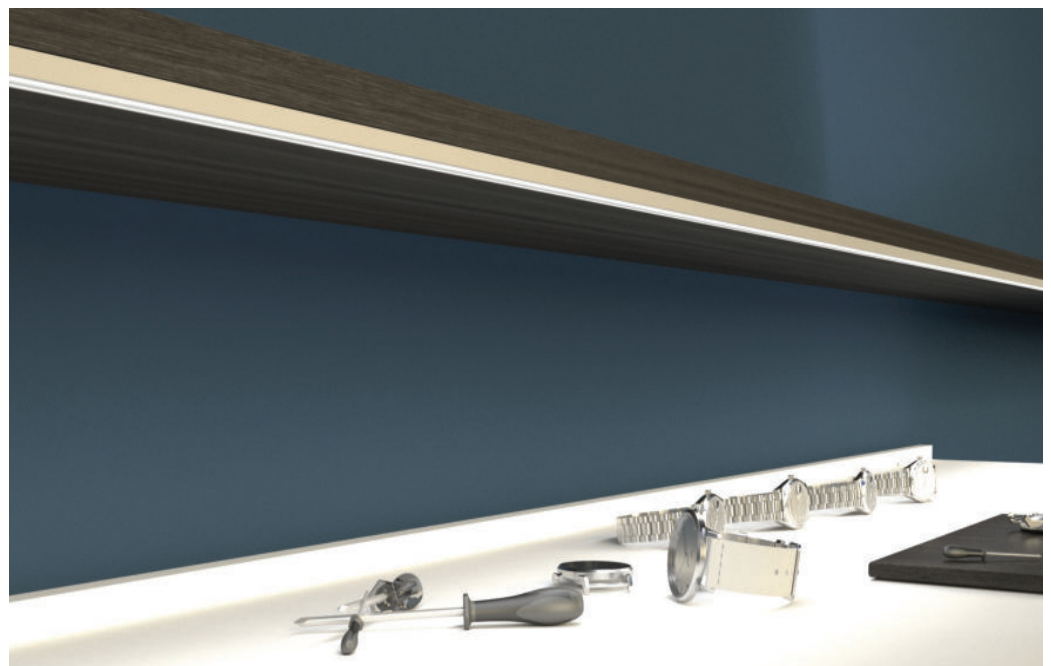

# SURFACE14 EE7F/TY



max 14 mm



surface  
nawierzchniowe  
Aufbauprofile  
surface



furniture  
meblowe  
Möbel-  
mobilier

- hidden mounting  
- many system accessories  
available

- ukryte mocowanie  
- wiele akcesoriów  
systemowych do wyboru

- eine versteckte Befestigung  
- viele Systemzubehörteile zur  
Auswahl

- fixation cachée  
- de nombreux accessoires du  
système au choix



more  
information



więcej  
szczegółów

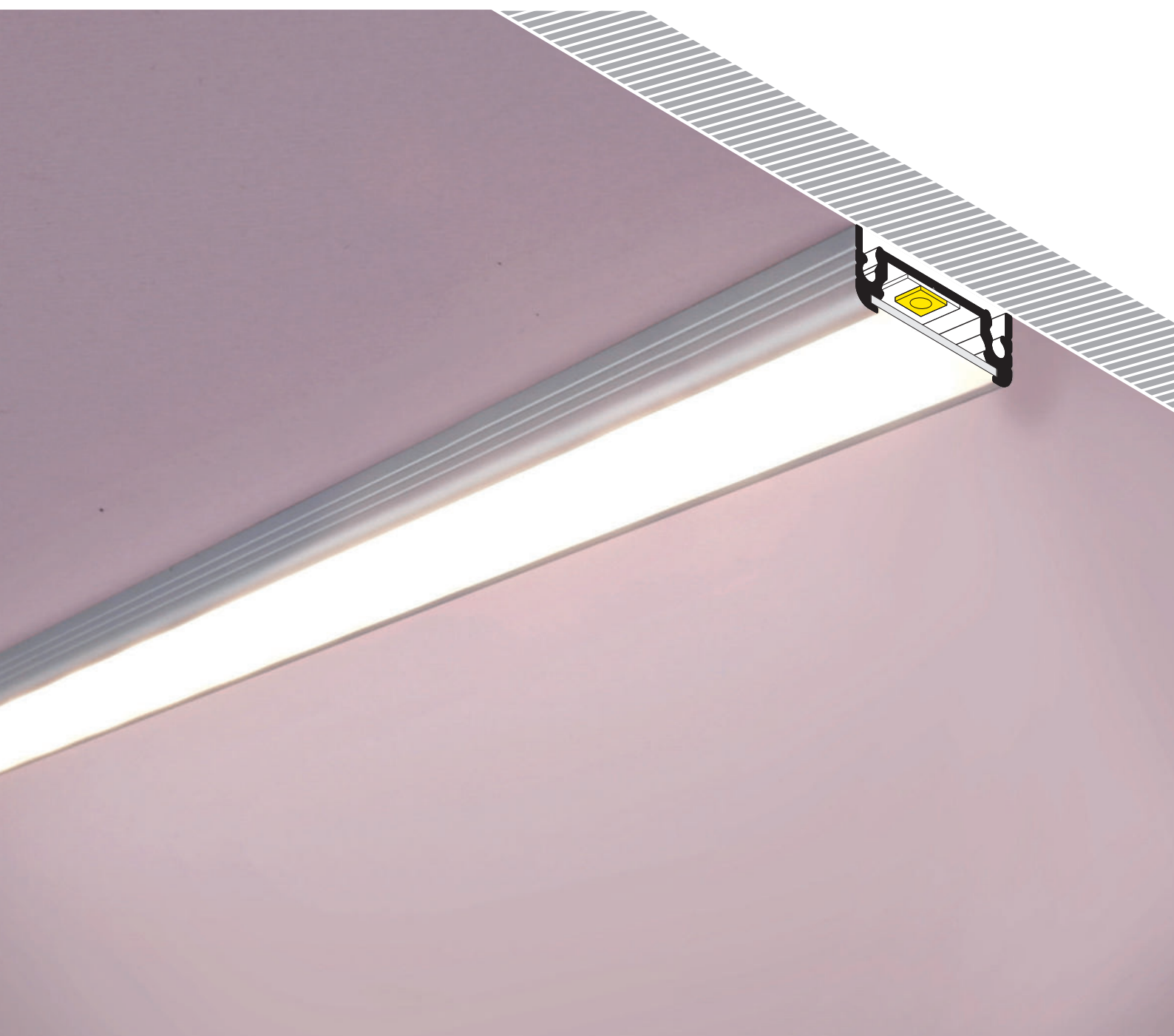

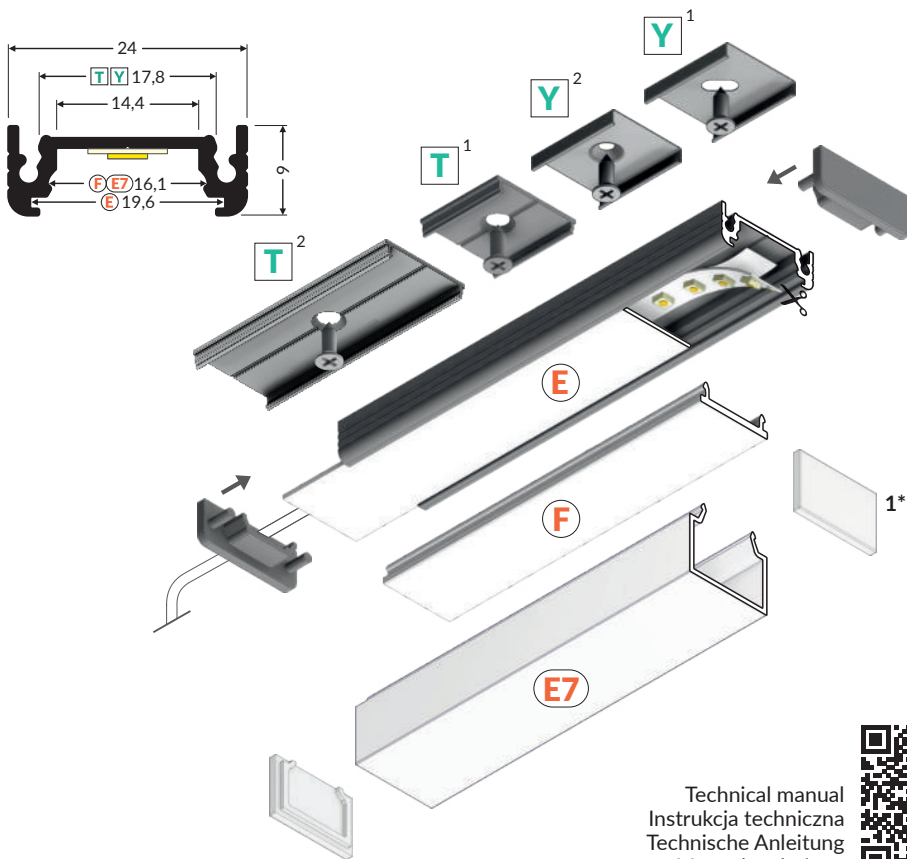

Technical manual  
Instrukcja techniczna  
Technische Anleitung  
Manuel technique



**Y<sup>1</sup>** → 208

mounting plate Y  
uchwyt Y  
Halter Y  
fixation Y

**Y<sup>2</sup>** → 208

mounting plate Y cone  
uchwyt Y cone  
Halter Y cone  
fixation Y cône

**T<sup>1</sup>** → 204

mounting plate T  
uchwyt T  
Halter T  
fixation T

**T<sup>2</sup>** → 204

connector T 180 deg  
łącznik T 180 st  
Verbinder T 180 Grad  
connecteur T 180 degrés

**E** → 198

diffuser E slide  
klosz E wsuwany  
Abdeckung E einschiebbar  
diffuseur E coulissant

**F** → 199

diffuser F click  
klosz F klik  
Abdeckung F einclipsbar  
diffuseur F clic

**E7** → 198

diffuser E7 click  
klosz E7 klik  
Abdeckung E7 einclipsbar  
diffuseur E7 clic

**1\*** → 198

end cap E7  
zaślepka E7  
Endkappe E7  
embout E7

white painted biały malowany weiß lackiert peint en blanc	anodized anodowany eloxiert surface anodisée	black anodized czarny anodowany schwarz eloxiert noir anodisé	raw aluminium surowe aluminium Rohaluminium aluminium brut
1000 mm <b>A2010001</b>	<b>A2010020</b>	<b>A2010021</b>	<b>A2010000</b>
2000 mm <b>A2020001</b>	<b>A2020020</b>	<b>A2020021</b>	<b>A2020000</b>
3000 mm <b>A2170001</b>	<b>A2170020</b>	<b>A2170021</b>	<b>A2170000</b>
4050 mm <b>A2180001</b>	<b>A2180020</b>	<b>A2180021</b>	<b>A2180000</b>

end cap SURFACE14 gen2  
zaślepka SURFACE14 gen2  
Endkappe SURFACE14 gen2  
embout SURFACE14 gen2



white biały weiß blanc	silver srebrny silbern argent	<b>A2980001</b>	<b>A2980040</b>
black czarny schwarz noir	grey szary grau gris	<b>A2980002</b>	<b>A2980022</b>

end cap SURFACE14 gen2 with hole  
zaślepka SURFACE14 gen2 z otworem  
Endkappe SURFACE14 gen2 mit Öffnung  
embout SURFACE14 gen2 avec un trou



white biały weiß blanc	silver srebrny silbern argent	<b>A2970001</b>	<b>A2970040</b>
black czarny schwarz noir	grey szary grau gris	<b>A2970002</b>	<b>A2970022</b>

connector SURFACE14  
łącznik SURFACE14 90 st  
Verbinder SURFACE14 90 Grad  
connecteur SURFACE14 90 degrés

material: aluminium  
materiał: aluminium  
Material: Aluminium  
matériel: aluminium

white painted  
biały malowany  
weiß lackiert  
peint en blanc  
**A2990001**

anodized  
anodowany  
eloxiert  
surface anodisée  
**A2990020**

black anodized  
czarny anodowany  
schwarz eloxiert  
noir anodisé  
**A2990021**

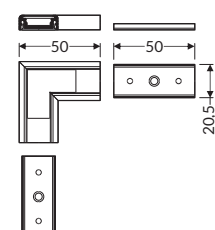

# SURFACE14.v2 EE7F/Y



max 14 mm



surface  
nawierzchniowe  
Aufbauprofile  
surface



furniture  
meblowe  
Möbel-  
mobilier

- a new generation of surface profiles
- basic and aesthetically pleasing furniture profile
- concealed fixing
- reduced weight
- updated design

- nowa generacja profili nawierzchniowych
- podstawowy i estetyczny profil meblowy
- ukryte mocowanie
- zredukowana waga
- odświeżony design

- neue Generation von Aufbauprofilen
- einfaches und ästhetisches Möbelprofil
- versteckte Befestigung
- reduziertes Gewicht
- aufgefrishtes Design

- nouvelle génération de profils de surface
- profilé de mobilier basique et esthétique
- fixation cachée
- poids réduit
- design rafraîchi



more  
information



więcej  
szczegółów





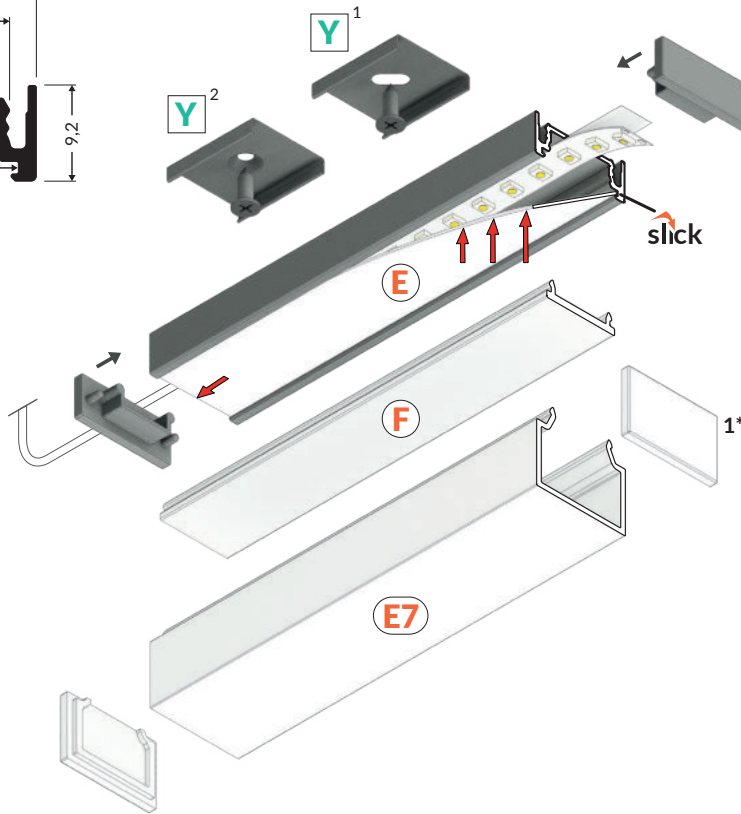
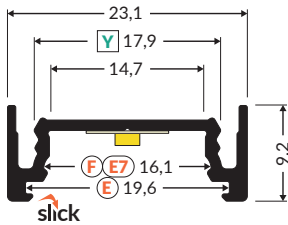

**Y<sup>1</sup>** → 208

mounting plate Y  
uchwyt Y  
Halter Y  
fixation Y

**Y<sup>2</sup>** → 208

mounting plate Y cone  
uchwyt Y cone  
Halter Y cone  
fixation Y cône

**E** → 198

diffuser E slide  
klosz E wsuwany  
Abdeckung E einziehbar  
diffuseur E coulissant

**F** → 199

diffuser F click  
klosz F klik  
Abdeckung F einclipsbar  
diffuseur F clic

**E7** → 198

diffuser E7 click  
klosz E7 klik  
Abdeckung E7 einclipsbar  
diffuseur E7 clic

**1\*** → 198

end cap E7  
zaślepka E7  
Endkappe E7  
embout E7



white painted  
biały malowany  
weiß lackiert  
peint en blanc



anodized  
anodowany  
eloxiert  
surface anodisée



black anodized  
czarny anodowany  
schwarz eloxiert  
noir anodisé



raw aluminium  
surowe aluminium  
Rohaluminium  
aluminium brut

1000 mm	K4000101	K4000120	K4000121	K4000100
2000 mm	K4000201	K4000220	K4000221	K4000200
3000 mm	K4000301	K4000320	K4000321	K4000300
4050 mm	K4000401	K4000420	K4000421	K4000400

end cap SURFACE14.v2  
zaślepka SURFACE14.v2  
Endkappe SURFACE14.v2  
embout SURFACE14.v2

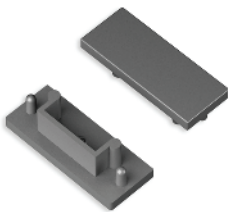

white  
biały  
weiß  
blanc  
K4999901

silver  
srebrny  
silbern  
argent  
K4999940

black  
czarny  
schwarz  
noir  
K4999902

grey  
szary  
grau  
gris  
K4999922



# SMART16 BC3/U4



max 16 mm



surface  
nawierzchniowe  
Aufbauprofile  
surface



furniture  
meblowe  
Möbel-  
mobilier

- Slick socket - easy assembly technology
- 2 channels for mounting bracket (with or without mounting surface distance)
- continuous line of light (when using LED strip 120 P/m and opal diffuser)

- gniazdo Slick - prosty montaż klosza
- 2 rowki - 2 poziomy przymocowania uchwyty (z dystansem od płaszczyzny montażowej lub bez)
- ciągła linia światła (przy zastosowaniu taśmy 120 P/m i klosza mlecznego)

- Sockel mit Slick Funktion
- eine einfache Montage der Abdeckung
- zwei Rillen - zwei Niveaus der Befestigung des Halters (mit einem Abstand von der Montagefläche und ohne Abstand)
- eine homogene Lichtlinie (unter Verwendung von LED Streifen mit 120 leds/m und einer opalen Abdeckung)

- prise avec fonction Slick - installation simple du diffuseur
- 2 rainures - 2 niveaux de montage de la fixation (avec ou sans distance de la surface de montage)
- une ligne continue de lumière (en utilisant un ruban 120 P/M. et un diffuseur opaque)



more  
information



więcej  
szczegółów



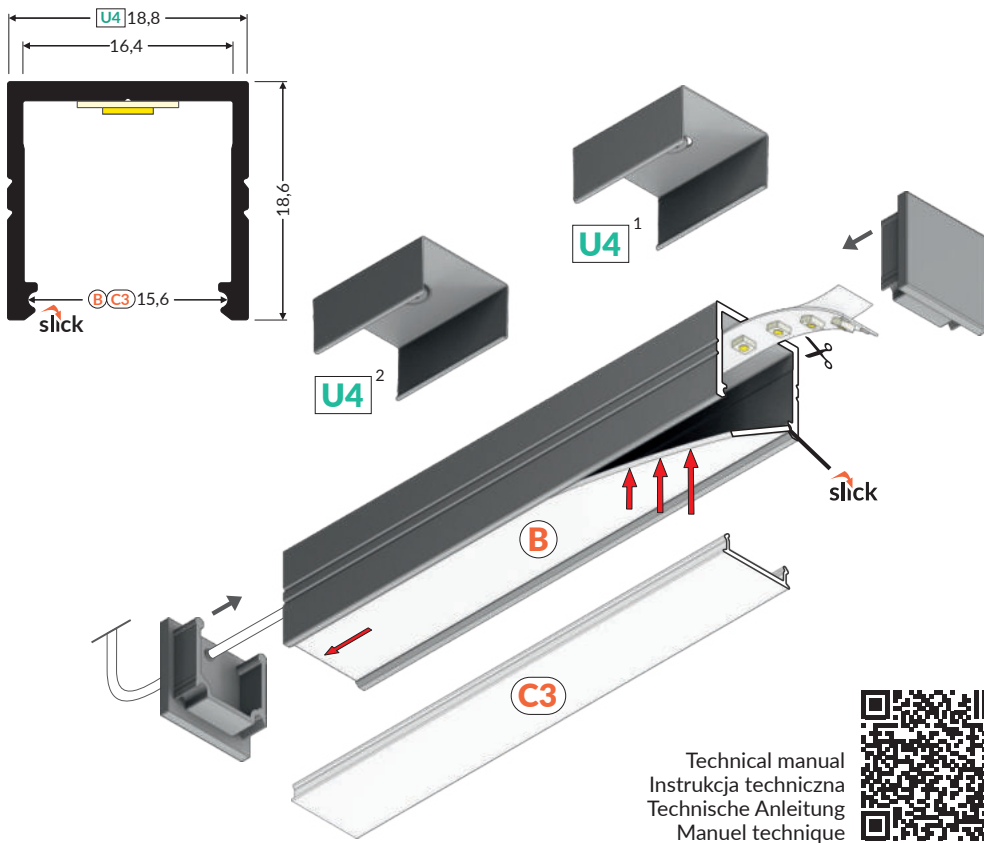

**U4**<sup>1</sup> → 205

mounting plate U4  
uchwyt U4  
Halter U4  
fixation U4

**U4**<sup>2</sup> → 205

mounting plate U4 cone  
uchwyt U4 cone  
Halter U4 cone  
fixation U4 cône

**B** → 194

diffuser B slide  
klosz B wsuwany  
Abdeckung B einschiebbar  
diffuseur B coulissant

**C3** → 196

diffuser C3 click  
klosz C3 klik  
Abdeckung C3 einclipsbar  
diffuseur C3 clic

white painted biały malowany weiß lackiert peint en blanc	anodized anodowany eloxiert surface anodisée	black anodized czarny anodowany schwarz eloxiert noir anodisé	raw aluminium surowe aluminium Rohaluminium aluminium brut
1000 mm	<b>F1010001</b>	<b>F1010020</b>	<b>F1010000</b>
2000 mm	<b>F1020001</b>	<b>F1020020</b>	<b>F1020000</b>
3000 mm	<b>F1030001</b>	<b>F1030020</b>	<b>F1030000</b>
4050 mm	<b>F1040001</b>	<b>F1040020</b>	<b>F1040000</b>

end cap SMART16-BC3  
zaślepka SMART16-BC3  
Endkappe SMART16-BC3  
embout SMART16-BC3

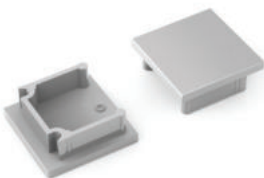

white biały weiß blanc	silver srebrny silbern argent
<b>F1999901</b>	<b>F1999940</b>

black czarny schwarz noir	grey szary grau gris
<b>F1999902</b>	<b>F1999922</b>

# LINEA20 EE7F/TY



max 20 mm



surface  
nawierzchniowe  
Aufbauprofile  
surface



suspended  
zwieszane  
hängend  
suspendu



furniture  
meblowe  
Möbel-  
mobilier



lighting  
oświetleniowe  
Beleuchtungs-  
éclairage d'ambiance

- over 20 accessories available
- possibility of suspension along with the power supply
- angled connections illuminated
- continuous light line (with 120 LEDs/m and opal diffuser applied)

- ponad 20 akcesoriów
- możliwość zawieszenia na zasilaniu
- świecące połączenia kątowe
- ciągła linia światła (przy użyciu taśm 120 P/m oraz klosza mlecznego)

- mehr als 20 Zubehörteile
- die Möglichkeit auf der Speisung aufzuhängen
- leuchtende Eckverbindungen
- eine homogene Lichtlinie (bei LED Streifen mit 120 LEDs/m und einer opalen Abdeckung)

- plus de 20 accessoires
- possibilité d'alimentation via la suspension
- connecteurs d'angles éclairés
- une ligne continue de lumière (en utilisant de rubans 120 LED/m et diffuseur opaque)



more  
information



więcej  
szczegółów

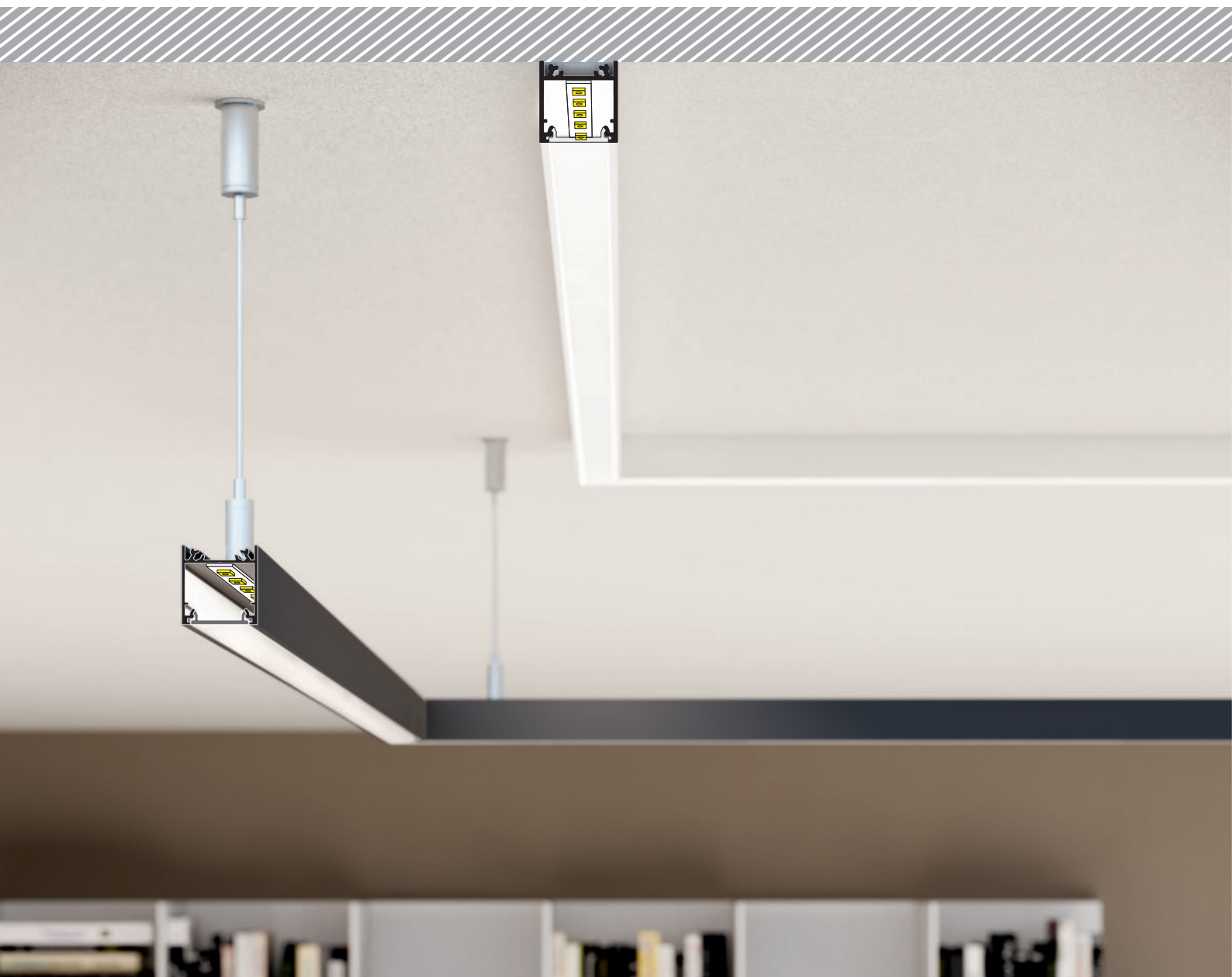



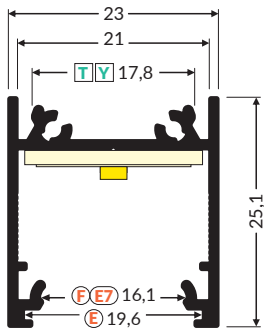

sling  
zawiesie  
Abhängung  
suspension  
→ 209

FIX16  
→ 191

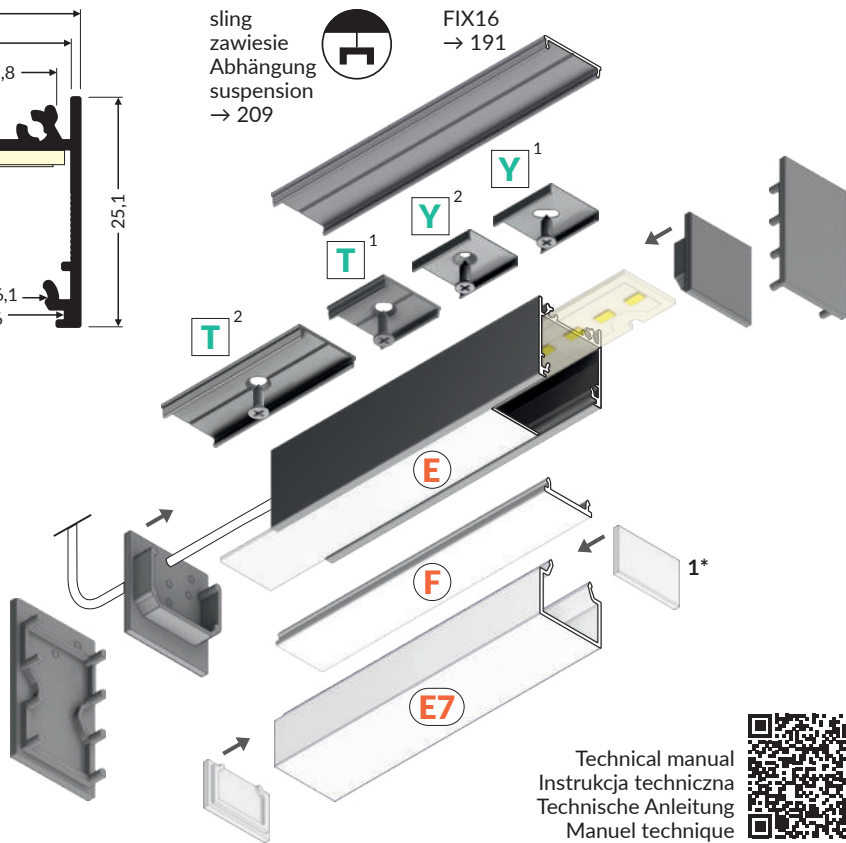

Technical manual  
Instrukcja techniczna  
Technische Anleitung  
Manuel technique



**Y<sup>1</sup>** → 208

mounting plate Y  
uchwyt Y  
Halter Y  
fixation Y

**Y<sup>2</sup>** → 208

mounting plate Y cone  
uchwyt Y cone  
Halter Y cone  
fixation Y cône

**T<sup>1</sup>** → 204

mounting plate T  
uchwyt T  
Halter T  
fixation T

**T<sup>2</sup>** → 204

connector T 180 deg  
łącznik T 180 st  
Verbinder T 180 Grad  
connecteur T 180 degrés

**E** → 198

diffuser E slide  
klosz E wsuwany  
Abdeckung E einschiebbar  
diffuseur E coulissant

**F** → 199

diffuser F click  
klosz F klik  
Abdeckung F einclipsbar  
diffuseur F clic

**E7** → 198

diffuser E7 click  
klosz E7 klik  
Abdeckung E7 einclipsbar  
diffuseur E7 clic

**1\*** → 198

end cap E7  
zaślepka E7  
Endkappe E7  
embout E7

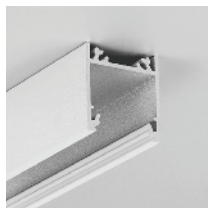

white painted  
biały malowany  
weiß lackiert  
peint en blanc

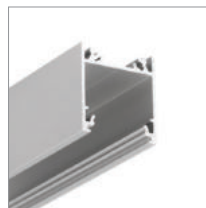

anodized  
anodowany  
eloxiert  
surface anodisée



black anodized  
czarny anodowany  
schwarz eloxiert  
noir anodisé

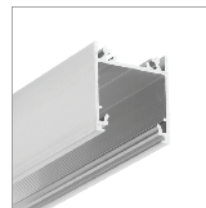

raw aluminium  
surowe aluminium  
Rohaluminium  
aluminium brut

1000 mm	<b>C1010001</b>	<b>C1010020</b>	<b>C1010021</b>	<b>C1010000</b>
2000 mm	<b>C1020001</b>	<b>C1020020</b>	<b>C1020021</b>	<b>C1020000</b>
3000 mm	<b>C1050001</b>	<b>C1050020</b>	<b>C1050021</b>	<b>C1050000</b>
4050 mm	<b>C1060001</b>	<b>C1060020</b>	<b>C1060021</b>	<b>C1060000</b>

end cap LINEA20  
zaślepka LINEA20  
Endkappe LINEA20  
embout LINEA20



white biały weiß blanc	silver srebrny silbern argent	<b>C1940001</b>	<b>C1940040</b>
black czarny schwarz noir	grey szary grau gris	<b>C1940002</b>	<b>C1940022</b>

end cap LINEA20-E7  
zaślepka LINEA20-E7  
Endkappe LINEA20-E7  
embout LINEA20-E7



white biały weiß blanc	silver srebrny silbern argent	<b>C1999901</b>	<b>C1999940</b>
black czarny schwarz noir	grey szary grau gris	<b>C1999902</b>	<b>C1999922</b>

LED mounting LINEA20  
mocowanie LED LINEA20  
LED Montageteil LINEA20  
fixation LED LINEA20



raw aluminium  
surowe aluminium  
Rohaluminium  
aluminium brut

1000 mm	<b>C6050000</b>
2000 mm	<b>C6060000</b>
3000 mm	<b>C6070000</b>
4050 mm	<b>C6080000</b>

material: aluminium  
material: aluminium  
Material: Aluminium  
matériel: aluminium

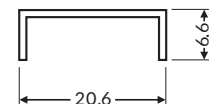



# SLING ZAWIESIE ABHÄNGUNG SUSPENSION

sling for LED mounting 1500  
zawiesie do uchwytu LED 1500  
Abhängung für LED Profil-Halter 1500  
kit de suspension pour support LED 1500

colour: chrome  
kolor: chrom  
Farben: Chrom  
couleur: chrom

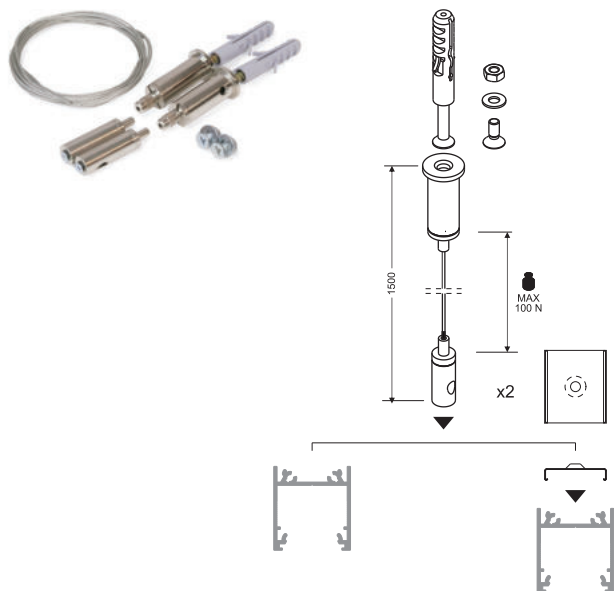

SELV sling 50 V 1500  
zawiesie SELV 50 V 1500  
Abhängung SELV 50V 1500  
kit de suspension SELV 50 V 1500

colours: white, silver, black  
kolory: biały, srebrny, czarny  
Farben: weiß, silbern, schwarz  
couleurs: blanc, argent, noir

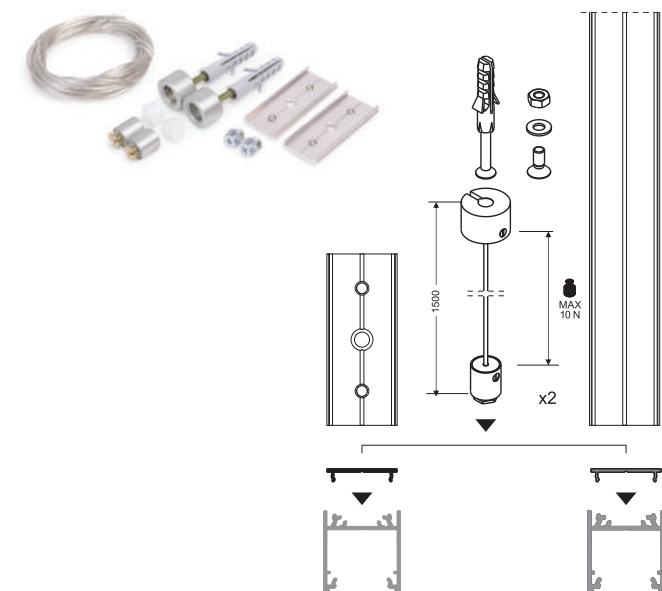

## SLING FOR LED MOUNTING 1500

Compatible with flexible mounting plates, allows fast and easy assembly of the luminaire mounting to the profile.

## ZAWIESIE DO UCHWYTU LED 1500

Kompatybilność z uchwytami sprężystymi, pozwala na szybki i łatwy montaż oprawy. Możliwy jest również montaż bezpośrednio do profilu.

## ABHÄNGUNG FÜR LED PROFIL-HALTER 1500

Die Anpassung an die flexiblen Halter ermöglicht eine schnelle und einfache Montage der Leuchte. Möglich ist auch die Montage direkt an das Profil.

## KIT DE SUSPENSION POUR SUPPORT LED 1500.

La compatibilité avec les supports flexibles permet un montage rapide et facile du luminaire. Il est également possible de le monter directement sur le profilé.

## SELV SLING 50 V 1500

It provides a minimalistic look - no additional wires required.

## ZAWIESIE SELV 50 V 1500

Zapewnia minimalistyczny wygląd - bez konieczności doprowadzania dodatkowych przewodów.

## ABHÄNGUNG SELV 50 V 1500

Sie sichert schlichtes Aussehen - ohne die Notwendigkeit zusätzliche Kabel durchzuführen.

## KIT DE SUSPENSION SELV 50 V 1500

Fournit un look minimaliste - sans avoir besoin de câbles supplémentaires.

Using FIX16 profile creates an aesthetic, closed form

Przy zastosowaniu profilu FIX16 tworzymy estetyczną, domkniętą od góry oprawę.

Bei dem Anwenden von dem Profil FIX16 bildet man eine ästhetische von oben geschlossene Leuchte.

Lors de l'utilisation du profilé FIX16, nous créons un cadre esthétique, fermé par le haut.



# CONNECTION POSSIBILITY

## MOŻLIWOŚCI ŁĄCZENIA

## VERBINDUNGSMÖGLICHKEITEN

## COMBINAISON POSSIBLE

### ANGULAR CONNECTORS

Thanks to five different angle connectors (60° / 90° / 120° / 135° / 180°) it is possible to create many various lighting systems – with no need to cut the profile at an angle. Bent connectors allows to connect profiles in two planes, at two angles: 90° on the inside and 270° on the outside.

### ŁĄCZNIKI KĄTOWE

Dzięki łącznikom o pięciu różnych kątach (60° / 90° / 120° / 135° / 180°) możliwe jest tworzenie wielu różnych układów oświetlenia bez konieczności cięcia profilu pod skosem. Łączniki gięte umożliwiają łączenie profili w dwóch płaszczyznach, pod dwoma kątami: wewnętrznym 90° i zewnętrznym 270°.

### ECKVERBINDER

Dank den Eckverbindern mit fünf unterschiedlichen Winkeln (60° / 90° / 120° / 135° / 180°) möglich ist die Bildung von vielen unterschiedlichen Lichtvarianten ohne das Profil auf Gehrung zuschneiden müssen. Gebogene Verbindungsstücke ermöglichen das Verbinden von zwei Profilen in zwei Ebenen, unter zwei Winkeln; dem inneren Winkel von 90° und dem äußeren Winkel von 270°.

### CONNECTEURS D'ANGLES

Grâce à des connecteurs avec cinq angles différents (60° / 90° / 120° / 135° / 180°), il est possible de créer de nombreux systèmes d'éclairage différents sans qu'il soit nécessaire de couper le profilé en angle. Les connecteurs coudés vous permettent de connecter des profilés dans deux plans, à deux angles: 90° interne et 270° externe.

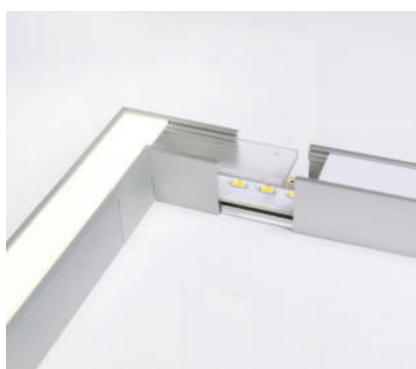

The component made of clear fabric provides secure connection, letting light through at the same time. Thanks to that, the luminaire can illuminate on the entire surface of the diffuser – even in the corners.

Element z przezroczystego tworzywa zapewnia stabilizację łączenia, jednocześnie przepuszczając światło. Dzięki temu oprawa może świecić na całej powierzchni klosza - również w rogach.

Ein Element aus durchsichtigem Kunststoff sichert die Stabilisierung der Verbindung und gleichzeitig lässt das Licht durch. Dadurch kann die Leuchte auf der ganzen Fläche der Abdeckung leuchten - auch in den Ecken.

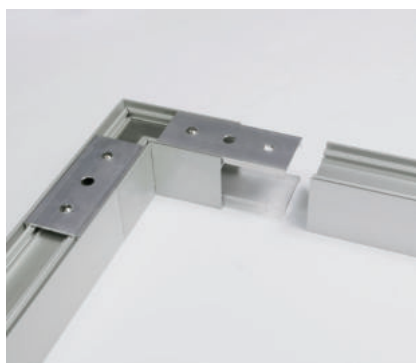

Un élément en matériau transparent assure la stabilisation de la connexion, tout en laissant passer la lumière. Grâce à cela, le luminaire peut briller sur toute la longueur, même dans les angles

# CONNECTORS ŁĄCZNIKI VERBINDER CONNECTEURS

material: aluminium, polycarbonate  
materiał: aluminium, poliwęglan  
Material: Aluminium, polycarbonate  
matériel: aluminium, polycarbonate

connector LINEA20 60 deg  
łącznik LINEA20 60 st  
Verbinder LINEA20 60 Grad  
connecteur LINEA20 60 degrés

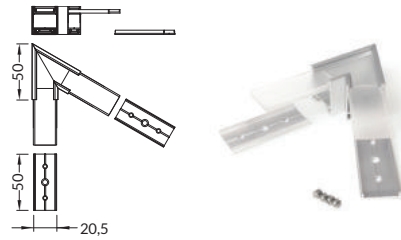

white painted  
biały malowany  
weiß lackiert  
peint en blanc  
**C1850001**

anodized  
anodowany  
eloxiert  
surface anodisée  
**C1850020**

black anodized  
czarny anodowany  
schwarz eloxiert  
noir anodisé  
**C1850002**

connector LINEA20 90 deg  
łącznik LINEA20 90 st  
Verbinder LINEA20 90 Grad  
connecteur LINEA20 90 degrés

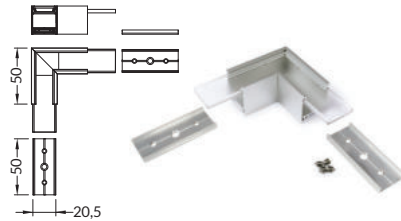

white painted  
biały malowany  
weiß lackiert  
peint en blanc  
**C1860001**

anodized  
anodowany  
eloxiert  
surface anodisée  
**C1860020**

black anodized  
czarny anodowany  
schwarz eloxiert  
noir anodisé  
**C1860002**

connector LINEA20 90 deg bent  
łącznik LINEA20 90 st gięty  
Verbinder LINEA20 90 Grad gebogen  
connecteur LINEA20 90 degrés plié

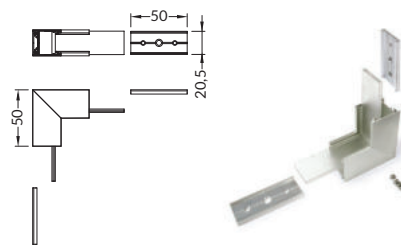

white painted  
biały malowany  
weiß lackiert  
peint en blanc  
**C1870001**

anodized  
anodowany  
eloxiert  
surface anodisée  
**C1870020**

black anodized  
czarny anodowany  
schwarz eloxiert  
noir anodisé  
**C1870002**

connector LINEA20 120 deg  
łącznik LINEA20 120 st  
Verbinder LINEA20 120 Grad  
connecteur LINEA20 120 degrés

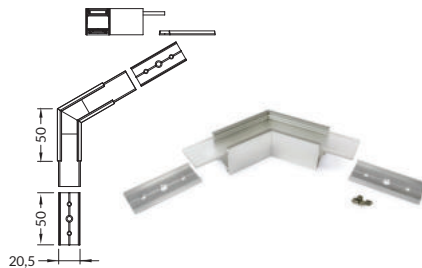

white painted  
biały malowany  
weiß lackiert  
peint en blanc  
**C1880001**

anodized  
anodowany  
eloxiert  
surface anodisée  
**C1880020**

black anodized  
czarny anodowany  
schwarz eloxiert  
noir anodisé  
**C1880002**

connector LINEA20 135 deg  
łącznik LINEA20 135 st  
Verbinder LINEA20 135 Grad  
connecteur LINEA20 135 degrés

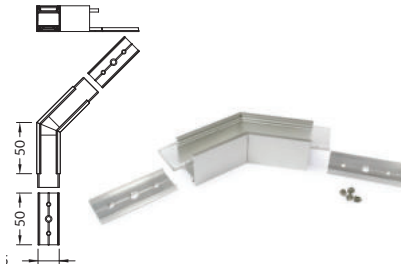

white painted  
biały malowany  
weiß lackiert  
peint en blanc  
**C1890001**

anodized  
anodowany  
eloxiert  
surface anodisée  
**C1890020**

black anodized  
czarny anodowany  
schwarz eloxiert  
noir anodisé  
**C1890002**

connector LINEA20 180 deg  
łącznik LINEA20 180 st  
Verbinder LINEA20 180 Grad  
connecteur LINEA20 180 degrés



**C1900000**

connector LINEA20 270 deg bent  
łącznik LINEA20 270 st gięty  
Verbinder LINEA20 270 Grad gebogen  
connecteur LINEA20 270 degrés plié

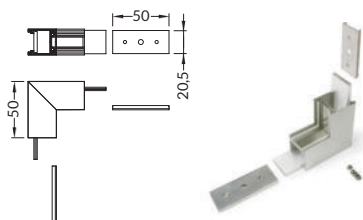

white painted  
biały malowany  
weiß lackiert  
peint en blanc  
**C1910001**

anodized  
anodowany  
eloxiert  
surface anodisée  
**C1910020**

black anodized  
czarny anodowany  
schwarz eloxiert  
noir anodisé  
**C1910002**



max 24 mm



surface  
nawierzchniowe  
Aufbauprofile  
surface



furniture  
meblowe  
Möbel-  
mobilier

- possibility of installing  
3 parallel 8 mm LED strips  
- Slick socket

- możliwość zastosowania  
równoległe 3 taśm 8 mm  
- gniazdo z funkcją Slick

- man kann gleichzeitig  
3 LED-Streifen mit 8mm  
Breite verwenden  
- Sockel mit Slick Funktion

- 3 rubans de 8 mm peuvent  
être utilisés en parallèle  
- prise avec fonction Slick



more  
information



więcej  
szczegółów



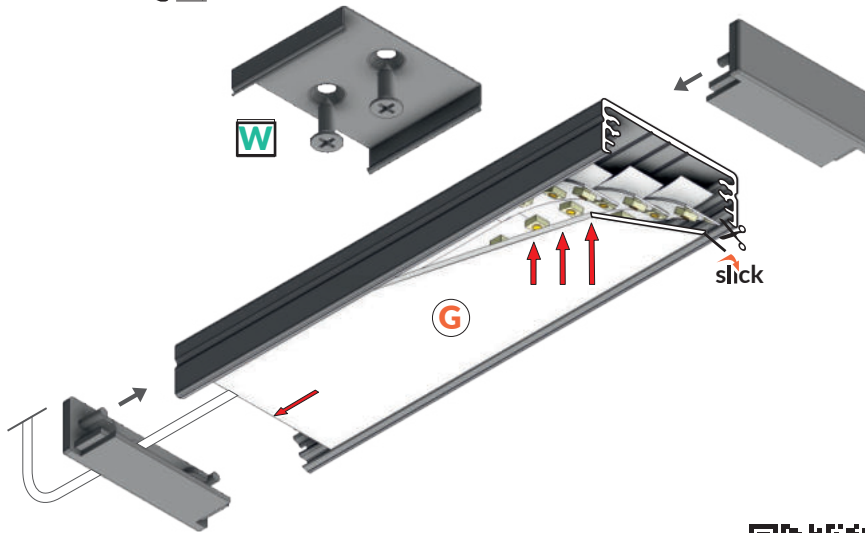
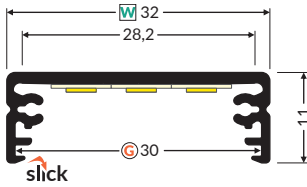

**W** → 207

mounting plate W cone  
uchwyt W cone  
Halter W cone  
fixation W cone /cône

**G** → 199

diffuser G slide  
klosz G wsuwany  
Abdeckung G einschiebbar  
diffuseur G coulissant

Technical manual  
Instrukcja techniczna  
Technische Anleitung  
Manuel technique

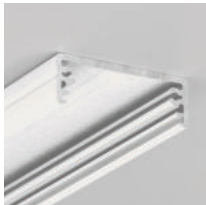

white painted  
biały malowany  
weiß lackiert  
peint en blanc

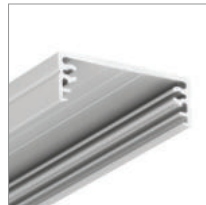

anodized  
anodowany  
eloxiert  
surface anodisée



black anodized  
czarny anodowany  
schwarz eloxiert  
noir anodisé



raw aluminium  
surowe aluminium  
Rohaluminium  
aluminium brut

1000 mm	<b>84020001</b>	<b>84020020</b>	<b>84020021</b>	<b>84020000</b>
2000 mm	<b>84030001</b>	<b>84030020</b>	<b>84030021</b>	<b>84030000</b>
3000 mm	<b>84340001</b>	<b>84340020</b>	<b>84340021</b>	<b>84340000</b>
4050 mm	<b>84350001</b>	<b>84350020</b>	<b>84350021</b>	<b>84350000</b>

end cap WIDE24  
zaślepka WIDE24  
Endkappe WIDE24  
embout WIDE24



white  
biały  
weiß  
blanc

**84040001 84040040**

black  
czarny  
schwarz  
noir

**84040002 84040022**

silver  
srebrny  
silbern  
argent

**84040040**

grey  
szary  
grau  
gris

**84040022**

end cap WIDE24 with hole  
zaślepka WIDE24 z otworem  
Endkappe WIDE24 mit Öffnung  
embout WIDE24 avec un trou



white  
biały  
weiß  
blanc

**84300001 84300040**

black  
czarny  
schwarz  
noir

**84300002 84300022**

silver  
srebrny  
silbern  
argent

**84300040**

grey  
szary  
grau  
gris

**84300022**



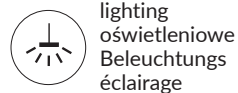
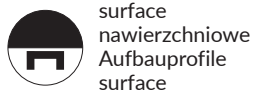

- part of a larger system for luminaire construction
- multiple installation methods
- continuous line of light in angled connections
- unlimited possibilities for light creation

- część większego systemu do budowy opraw oświetleniowych
- wiele sposobów montażu
- ciągła linia światła w połączeniach kątowych
- nieograniczone możliwości kreowania światła

- Teil eines größeren Systems für den Leuchtenbau
- mehrere Montagemethoden
- eine homogene Lichtlinie in Eckverbindungen
- unbegrenzte Möglichkeiten der Lichtgestaltung

- partie d'un très vaste système pour la création de luminaires
- des plusieurs options de montage
- une ligne lumineuse permanente dans les connecteurs angulaires
- des possibilités illimitées concernant la création de lumière



**VARIO30-01**  
**ACDE-9/TY**

sling  
zawiesie  
Abhängung  
suspension  
→ 209



FIX16  
→ 191

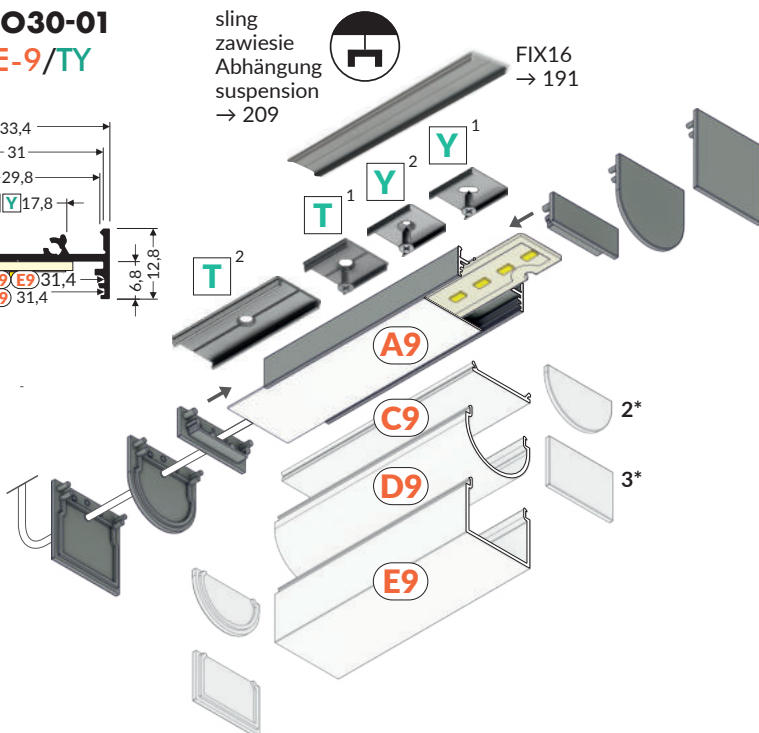
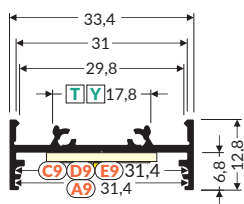

more  
information



więcej  
szczegółów



Technical manual  
Instrukcja techniczna  
Technische Anleitung  
Manuel technique

**Y<sup>1</sup>** → 208

mounting plate Y  
uchwyt Y  
Halter Y  
fixation Y

**Y<sup>2</sup>** → 208

mounting plate Y cone  
uchwyt Y cone  
Halter Y cone  
fixation Y cône

**T<sup>1</sup>** → 204

mounting plate T  
uchwyt T  
Halter T  
fixation T

**T<sup>2</sup>** → 204

connector T 180 deg  
łącznik T 180 st  
Verbinder T 180 Grad  
connecteur T 180 degrés

**A9** → 194

diffuser A9 slide  
klosz A9 wsuwany  
Abdeckung A9 einziehbar  
diffuseur A9 coulissant

**C9** → 197

diffuser C9 click  
klosz C9 klik  
Abdeckung C9 einclipsbar  
diffuseur C9 clic

**D9** → 198

diffuser D9 click  
klosz D9 klik  
Abdeckung D9 einclipsbar  
diffuseur D9 clic

**E9** → 199

diffuser E9 click  
klosz E9 klik  
Abdeckung E9 einclipsbar  
diffuseur E9 clic



white painted  
biały malowany  
weiß lackiert  
peint en blanc



anodized  
anodowany  
eloxiert  
surface anodisée



black anodized  
czarny anodowany  
schwarz eloxiert  
noir anodisé



raw aluminium  
surowe aluminium  
Rohaluminium  
aluminium brut

1000 mm	<b>V3010001</b>	<b>V3010020</b>	<b>V3010021</b>	<b>V3010000</b>
2000 mm	<b>V3020001</b>	<b>V3020020</b>	<b>V3020021</b>	<b>V3020000</b>
3000 mm	<b>V3030001</b>	<b>V3030020</b>	<b>V3030021</b>	<b>V3030000</b>
4050 mm	<b>V3040001</b>	<b>V3040020</b>	<b>V3040021</b>	<b>V3040000</b>

end cap VARIO30-01  
zaślepka VARIO30-01  
Endkappe LINEA20  
embout LINEA20



white  
biały  
weiß  
blanc  
**V4870001** **V4870040**

black  
czarny  
schwarz  
noir  
**V4870002** **V4870022**

end cap VARIO30-01-D9  
zaślepka VARIO30-01-D9  
Endkappe VARIO30-01-D9  
embout VARIO30-01-D9



opal  
mleczny  
opal  
opaque  
**V4500038**

end cap VARIO30-01-E9  
zaślepka VARIO30-01-E9  
Endkappe VARIO30-01-E9  
embout VARIO30-01-E9

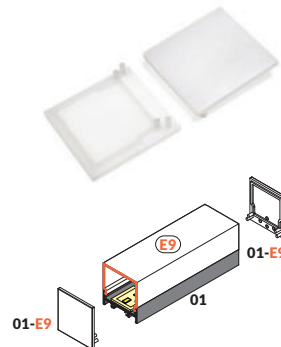

opal  
mleczny  
opal  
opaque  
**V4510038**

**2\*** → 198

end cap D9  
zaślepka D9  
Endkappe D9  
embout D9

**3\*** → 199

end cap E9  
zaślepka E9  
Endkappe E9  
embout E9

# VARIO30-02 ACDE-9/TY

sling  
zawieszanie  
Abhängung  
suspension  
→ 209

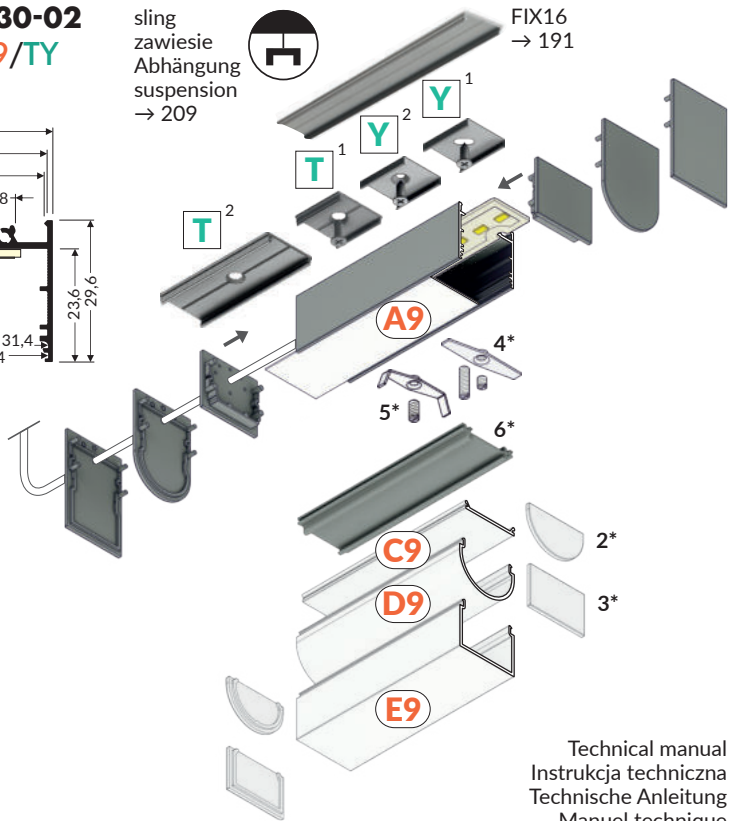
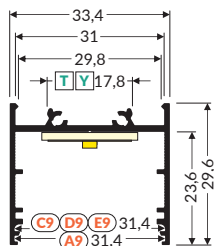

Technical manual  
Instrukcja techniczna  
Technische Anleitung  
Manuel technique



more  
information



więcej  
szczegółów



**Y<sup>1</sup>** → 208

mounting plate Y  
uchwyt Y  
Halter Y  
fixation Y

**Y<sup>2</sup>** → 208

mounting plate Y cone  
uchwyt Y cone  
Halter Y cone  
fixation Y cône

**T<sup>1</sup>** → 204

mounting plate T  
uchwyt T  
Halter T  
fixation T

**T<sup>2</sup>** → 204

connector T 180 deg  
łącznik T 180 st  
Verbindeur T 180 Grad  
connecteur T 180 degrés

**A9** → 194

diffuser A9 slide  
klosz A9 wsuwany  
Abdeckung A9 einziehbar  
diffuseur A9 coulissant

**C9** → 197

diffuser C9 click  
klosz C9 klik  
Abdeckung C9 einclipsbar  
diffuseur C9 clic

**D9** → 198

diffuser D9 click  
klosz D9 klik  
Abdeckung D9 einclipsbar  
diffuseur D9 clic

**E9** → 199

diffuser E9 click  
klosz E9 klik  
Abdeckung E9 einclipsbar  
diffuseur E9 clic

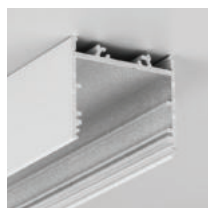

white painted  
biały malowany  
weiß lackiert  
peint en blanc



anodized  
anodowany  
eloxiert  
surface anodisée



black anodized  
czarny anodowany  
schwarz eloxiert  
noir anodisé

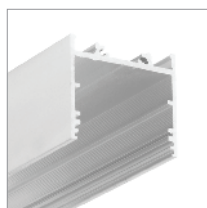

raw aluminium  
surowe aluminium  
Rohaluminium  
aluminium brut

1000 mm	V3050001
2000 mm	V3060001
3000 mm	V3070001
4050 mm	V3080001

1000 mm	V3050020
2000 mm	V3060020
3000 mm	V3070020
4050 mm	V3080020

1000 mm	V3050021
2000 mm	V3060021
3000 mm	V3070021
4050 mm	V3080021

1000 mm	V3050000
2000 mm	V3060000
3000 mm	V3070000
4050 mm	V3080000

end cap VARIO30-02  
zaślepka VARIO30-02  
Endkappe VARIO30-02  
embout VARIO30-02

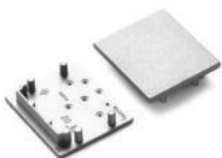

white  
biały  
weiß  
blanc

V4880001

silver  
srebrny  
silbern  
argent

V4880040

black  
czarny  
schwarz  
noir

V4880002

grey  
szary  
grau  
gris

V4880022

end cap VARIO30-02-D9  
zaślepka VARIO30-02-D9  
Endkappe VARIO30-02-D9  
embout VARIO30-02-D9

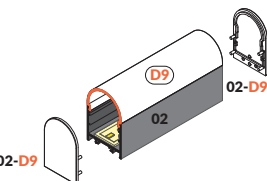

opal  
mleczny  
opal  
opaque

V4540038

end cap VARIO30-02-E9  
zaślepka VARIO30-02-E9  
Endkappe VARIO30-02-E9  
embout VARIO30-02-E9

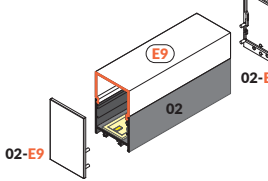

opal  
mleczny  
opal  
opaque

V4550038

**2\*** → 198

end cap D9  
zaślepka D9  
Endkappe D9  
embout D9

**3\*** → 199

end cap E9  
zaślepka E9  
Endkappe E9  
embout E9

**4\*** → 210

LED clamp VARIO30  
docisk LED VARIO30  
LED Klemme VARIO30  
clip de fixation LED VARIO30

**5\*** → 210

LED clamp VARIO30-1  
docisk LED VARIO30-1  
LED Klemme VARIO30-1  
clip de fixation LED VARIO30 1

**6\*** → 210

LED mounting VARIO30  
mocowanie LED VARIO30  
LED Montageteil VARIO30  
barre de fixation LED VARIO30

# CONNECTORS ŁĄCZNIKI VERBINDER CONNECTEURS

material: aluminium, polycarbonate  
 materiał: aluminium, poliwęglan  
 Material: Aluminium, Polycarbonat  
 matériel: aluminium, polycarbonate

connector VARIO30-02 60 deg  
 łącznik VARIO30-02 60 st  
 Verbinder VARIO30-02 60 Grad  
 connecteur VARIO30-02 60 degrés

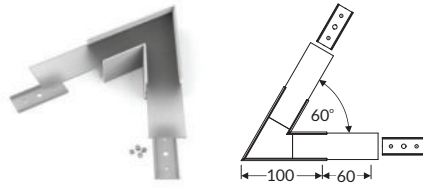

white painted  
 biały malowany  
 weiß lackiert  
 peint en blanc  
**V4660001S**

anodized  
 anodowany  
 eloxiert  
 surface anodisée  
**V4660020S**

black anodized  
 czarny anodowany  
 schwarz eloxiert  
 noir anodisé  
**V4660021S**

connector VARIO30-02 90 deg  
 łącznik VARIO30-02 90 st  
 Verbinder VARIO30-02 90 Grad  
 connecteur VARIO30-02 90 degrés

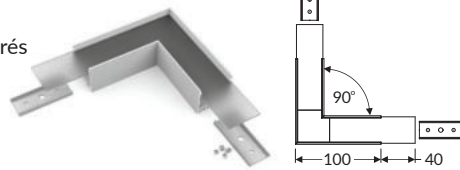

white painted  
 biały malowany  
 weiß lackiert  
 peint en blanc  
**V4670001S**

anodized  
 anodowany  
 eloxiert  
 surface anodisée  
**V4670020S**

black anodized  
 czarny anodowany  
 schwarz eloxiert  
 noir anodisé  
**V4670021S**

connector VARIO30-02 90 deg bent  
 łącznik VARIO30-02 90 st gięty  
 Verbinder VARIO30-02 90 Grad gebogen  
 connecteur VARIO30-02 90 degrés plié

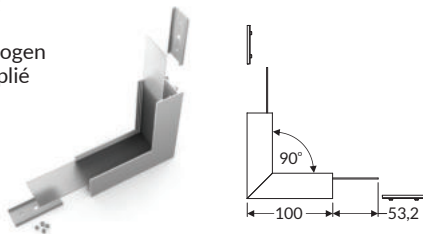

white painted  
 biały malowany  
 weiß lackiert  
 peint en blanc  
**V4680001S**

anodized  
 anodowany  
 eloxiert  
 surface anodisée  
**V4680020S**

black anodized  
 czarny anodowany  
 schwarz eloxiert  
 noir anodisé  
**V4680021S**

connector VARIO30-02 120 deg  
 łącznik VARIO30-02 120 st  
 Verbinder VARIO30-02 120 Grad  
 connecteur VARIO30-02 120 degrés

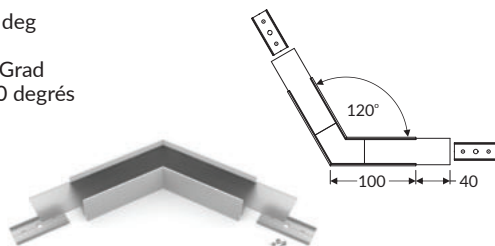

white painted  
 biały malowany  
 weiß lackiert  
 peint en blanc  
**V4690001S**

anodized  
 anodowany  
 eloxiert  
 surface anodisée  
**V4690020S**

black anodized  
 czarny anodowany  
 schwarz eloxiert  
 noir anodisé  
**V4690021S**

connector VARIO30-02 135 deg  
 łącznik VARIO30-02 135 st  
 Verbinder VARIO30-02 135 Grad  
 connecteur VARIO30-02 135 degrés

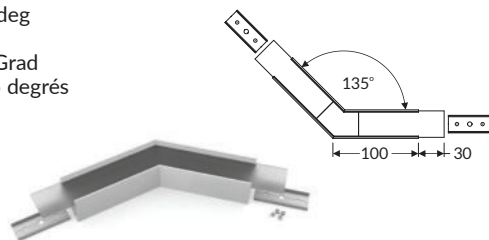

white painted  
 biały malowany  
 weiß lackiert  
 peint en blanc  
**V4700001S**

anodized  
 anodowany  
 eloxiert  
 surface anodisée  
**V4700020S**

black anodized  
 czarny anodowany  
 schwarz eloxiert  
 noir anodisé  
**V4700021S**

connector VARIO30-0203 180 deg  
 łącznik VARIO30-0203 180 st  
 Verbinder VARIO30-02 180 Grad  
 connecteur VARIO30-02 180 degrés



**V4640000S**

connector VARIO30-02 270 deg bent  
 łącznik VARIO30-02 270 st gięty  
 Verbinder VARIO30-02 270 Grad gebogen  
 connecteur VARIO30-02 270 degrés plié

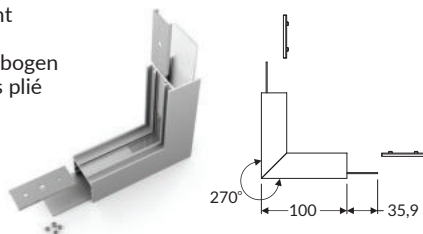

white painted  
 biały malowany  
 weiß lackiert  
 peint en blanc  
**V4710001S**

anodized  
 anodowany  
 eloxiert  
 surface anodisée  
**V4710020S**

black anodized  
 czarny anodowany  
 schwarz eloxiert  
 noir anodisé  
**V4710021S**





T/Y  
FIX16

08

03

power supply  
zasilacz  
Netzteil  
alimentation

variant 32

**VARIO30-03**  
**ACDE-9/TY**

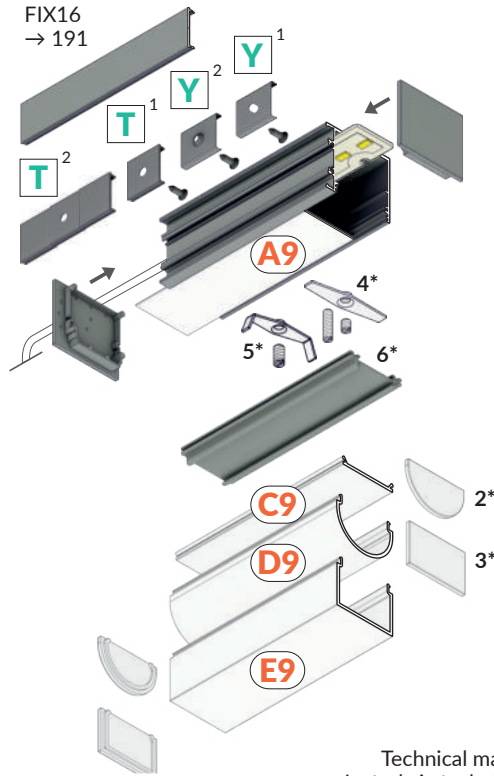
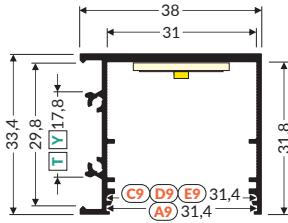

Technical manual  
Instrukcja techniczna  
Technische Anleitung  
Manuel technique



more information



więcej szczegółów



**Y<sup>1</sup>** → 208

mounting plate Y  
uchwyt Y  
Halter Y  
fixation Y

**Y<sup>2</sup>** → 208

mounting plate Y cone  
uchwyt Y cone  
Halter Y cone  
fixation Y cône

**T<sup>1</sup>** → 204

mounting plate T  
uchwyt T  
Halter T  
fixation T

**T<sup>2</sup>** → 204

connector T 180 deg  
łącznik T 180 st  
Verbinder T 180 Grad  
connecteur T 180 degrés

**A9** → 194

diffuser A9 slide  
klosz A9 wsuwany  
Abdeckung A9 einschiebbar  
diffuseur A9 coulissant

**C9** → 197

diffuser C9 click  
klosz C9 klik  
Abdeckung C9 einclipsbar  
diffuseur C9 clic

**D9** → 198

diffuser D9 click  
klosz D9 klik  
Abdeckung D9 einclipsbar  
diffuseur D9 clic

**E9** → 199

diffuser E9 click  
klosz E9 klik  
Abdeckung E9 einclipsbar  
diffuseur E9 clic

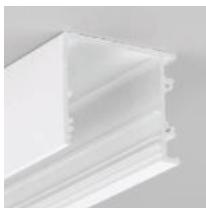

white painted  
biały malowany  
weiß lackiert  
peint en blanc

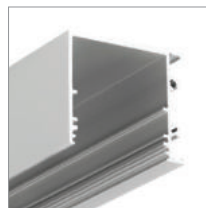

anodized  
anodowany  
eloxiert  
surface anodisée

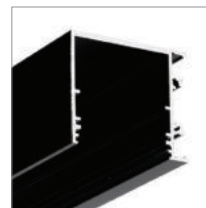

black anodized  
czarny anodowany  
schwarz eloxiert  
noir anodisé



raw aluminium  
surowe aluminium  
Rohaluminium  
aluminium brut

1000 mm	<b>V3090001</b>	<b>V3090020</b>	<b>V3090021</b>	<b>V3090000</b>
2000 mm	<b>V3100001</b>	<b>V3100020</b>	<b>V3100021</b>	<b>V3100000</b>
3000 mm	<b>V3110001</b>	<b>V3110020</b>	<b>V3110021</b>	<b>V3110000</b>
4050 mm	<b>V3120001</b>	<b>V3120020</b>	<b>V3120021</b>	<b>V3120000</b>

end cap VARIO30-03  
zaślepka VARIO30-03  
Endkappe VARIO30-03  
embout VARIO30-03

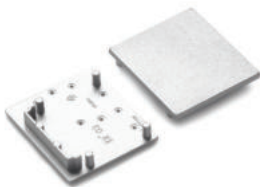

white biały weiß blanc	silver srebrny silbern argent	<b>V4890001</b>	<b>V4890040</b>
black czarny schwarz noir	grey szary grau gris	<b>V4890002</b>	<b>V4890022</b>

connector VARIO30-0203 180 deg  
łącznik VARIO30-0203 180 st  
Verbinder VARIO30-0203 180 Grad  
connecteur VARIO30-0203 180 degrés

material: aluminium, polycarbonate  
materiał: aluminium, poliwęglan  
Material: Aluminium, Polycarbonat  
matériel: aluminium, polycarbonate

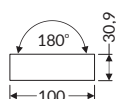

**V4640000s**

**2\*** → 198

end cap D9  
zaślepka D9  
Endkappe D9  
embout D9

**3\*** → 199

end cap E9  
zaślepka E9  
Endkappe E9  
embout E9

**4\*** → 210

LED clamp VARIO30  
docisk LED VARIO30  
LED Klemme VARIO30  
clip de fixation LED VARIO30

**5\*** → 210

LED clamp VARIO30-1  
docisk LED VARIO30-1  
LED Klemme VARIO30-1  
clip de fixation LED VARIO30 1

**6\*** → 210

LED mounting VARIO30  
mocowanie LED VARIO30  
LED Montageteil VARIO30  
barre de fixation LED VARIO30

# ASSISTANT PROFILES PROFILE POMOCNICZE HILFSPROFILE PROFILÉS AUXILIAIRES

## VARIO30-08

power supply profile  
profil zasilający  
Einspeisungsprofil  
profilé d'alimentation

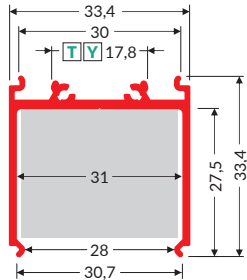

white painted  
biały malowany  
weiß lackiert  
peint en blanc



anodized  
anodowany  
eloxiert  
surface anodisée



black anodized  
czarny anodowany  
schwarz eloxiert  
noir anodisé



raw aluminium  
surowe aluminium  
Rohaluminium  
aluminium brut

1000 mm	V3290001	V3290020	V3290021	V3290000
2000 mm	V3300001	V3300020	V3300021	V3300000
3000 mm	V3310001	V3310020	V3310021	V3310000
4050 mm	V3320001	V3320020	V3320021	V3320000

## VARIO30-09

cover  
osłona  
Abdeckplatte  
cache

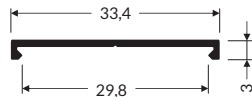

white painted  
biały malowany  
weiß lackiert  
peint en blanc



anodized  
anodowany  
eloxiert  
surface anodisée

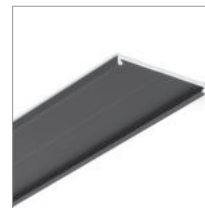

black anodized  
czarny anodowany  
schwarz eloxiert  
noir anodisé



raw aluminium  
surowe aluminium  
Rohaluminium  
aluminium brut

1000 mm	V3330001	V3330020	V3330021	V3330000
2000 mm	V3340001	V3340020	V3340021	V3340000
3000 mm	V3350001	V3350020	V3350021	V3350000
4050 mm	V3360001	V3360020	V3360021	V3360000

LED profile FIX16  
profil LED FIX16  
Profil LED FIX16  
profilé LED FIX16

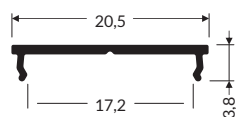

white painted  
biały malowany  
weiß lackiert  
peint en blanc



anodized  
anodowany  
eloxiert  
surface anodisée

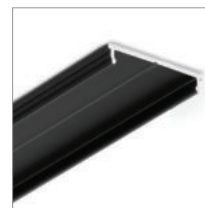

black anodized  
czarny anodowany  
schwarz eloxiert  
noir anodisé



raw aluminium  
surowe aluminium  
Rohaluminium  
aluminium brut

1000 mm	C6010001	C6010020	C6010021	C6010000
2000 mm	C6020001	C6020020	C6020021	C6020000
3000 mm	C6030001	C6030020	C6030021	C6030000
4050 mm	C6040001	C6040020	C6040021	C6040000

# PROMOTED VARIANTS WITH POWER SUPPLY DIFFUSER PROMOWANE WARIANTY Z OSŁONĄ ZASILACZA EMPFOHLENE VARIANTEN MIT SPEISELEITUNGSSCHUTZ VARIANTES RECOMMANDEES AVEC ALIMENTATION INTEGREE

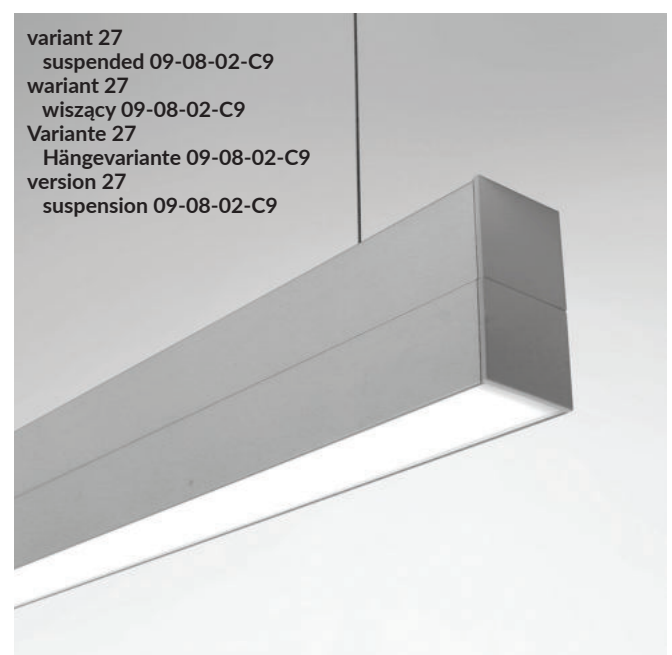
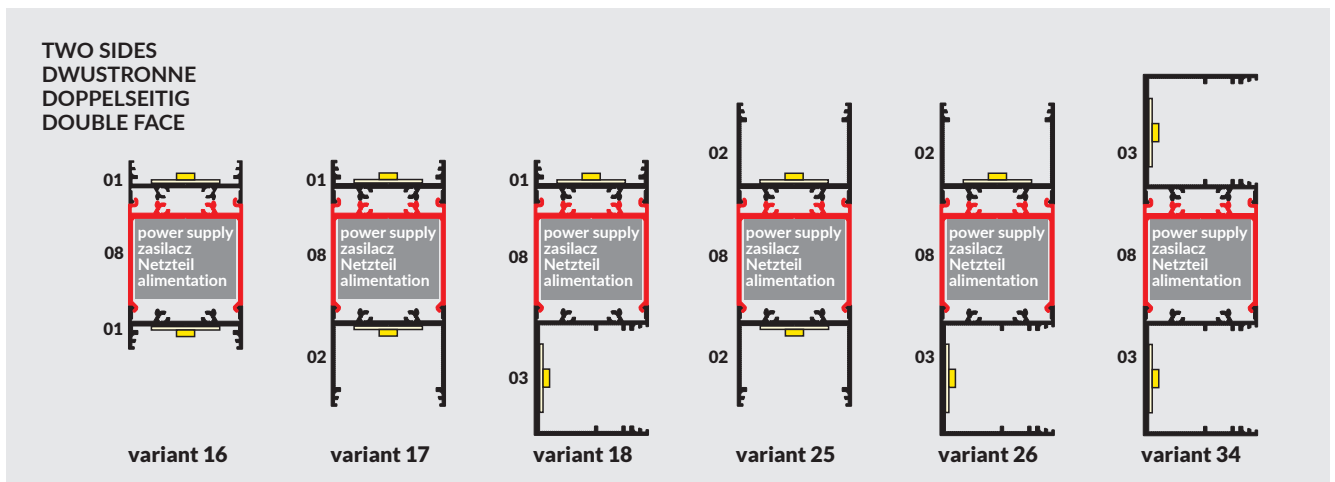
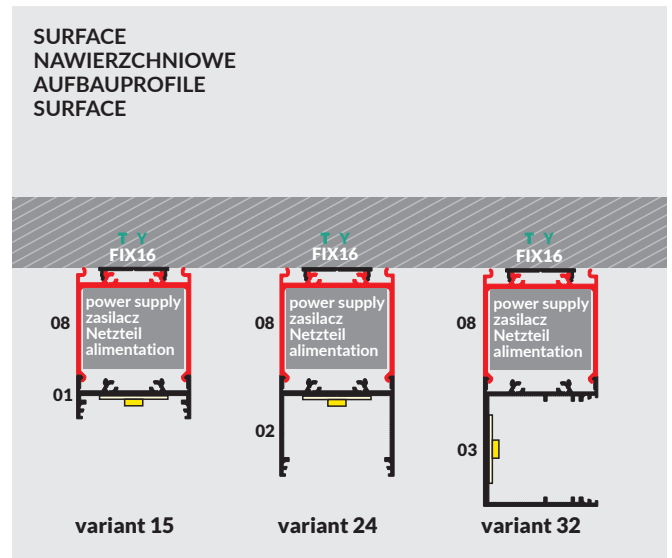
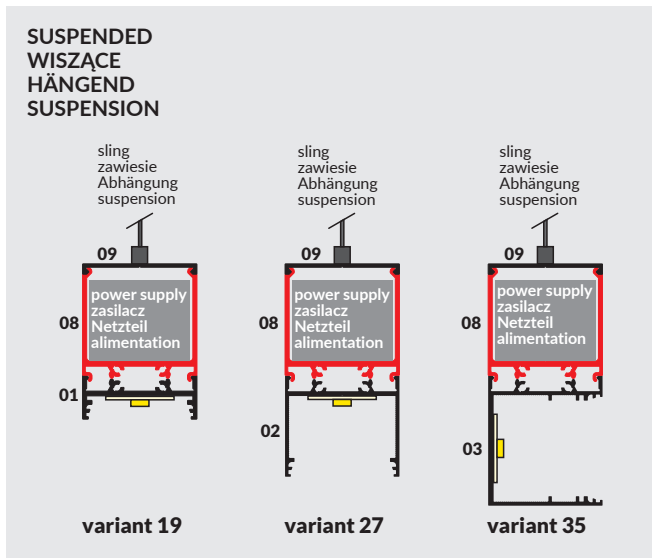



# END CAPS KNOW HOW OZNACZENIA ZAŚLEPEK BEZEICHNUNGEN DER ENDKAPPEN MARQUAGE DES EMBOUTS

diffuser / cover / profile  
klosz / osłona / profil  
Abdeckung / Abdeckplatte / Profil  
diffuseur / cache / profilé

names of profiles fitting with chosen end cap:  
nazwy profili pasujących do wybranej zaślepki:  
Die Namen der Profile, die mit einer gewählten Endkappe  
zusammenpassen:  
noms des profilés correspondant au embout sélectionné :  
- VARIO30-09

end cap dedicated to VARIO30-08 profile  
zaślepka dedykowana do profilu 08  
die für das Profil 08 vorgesehene Endkappe  
embout pour profilé 08

bottom of the LED profile  
dół profilu LED  
der untere Teil des LED Profils  
bas du profilé LED

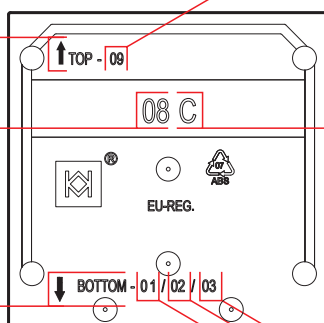

type of variant  
typ wariantu  
Variantentyp  
type de variante

names of profiles fitting with chosen end cap:  
nazwy profili pasujących do wybranej zaślepki:  
Namen der Profile, die für eine gewählte  
Endkappe passen:  
noms des profilés correspondant au bouchon  
sélectionné :  
- VARIO30-01  
- VARIO30-02  
- VARIO30-03

an example  
przykład  
Beispiel  
exemple

## VARIANT 18

end cap  
zaślepka  
Endkappe  
embout  
VARIO30-01

end cap  
zaślepka  
Endkappe  
embout  
VARIO30-08D

end cap  
zaślepka  
Endkappe  
embout  
VARIO30-03

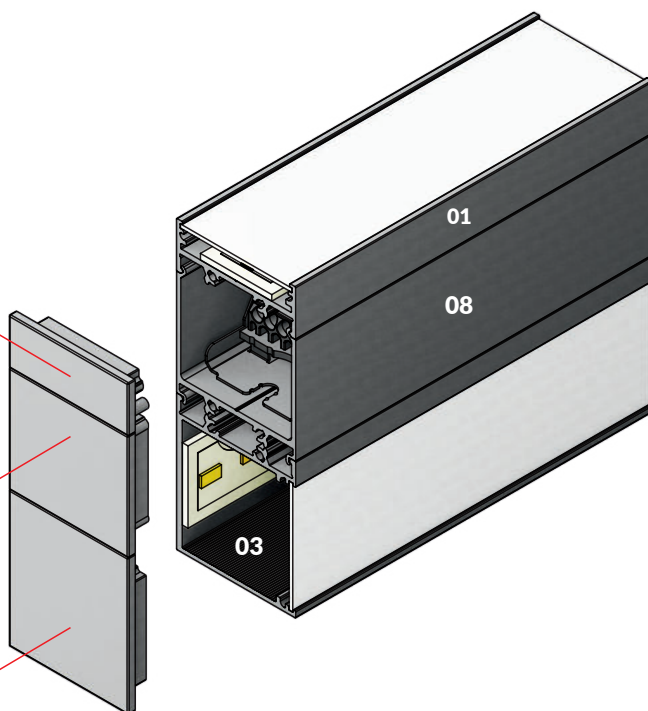

end cap  
zaślepka  
Endkappe  
embout  
VARIO30-01

end cap  
zaślepka  
Endkappe  
embout  
VARIO30-08D

end cap  
zaślepka  
Endkappe  
embout  
VARIO30-03

**08 END CAPS material: ABS**  
**ZAŚLEPKI 08 materiał: ABS**  
**ENDKAPPEN 08 material: ABS**  
**EMBOUT 08 matériel: ABS**

end cap VARIO30-08A  
 zaślepka VARIO30-08A  
 Endkappe VARIO30-08A  
 EMBOUT 08 matériel: ABS

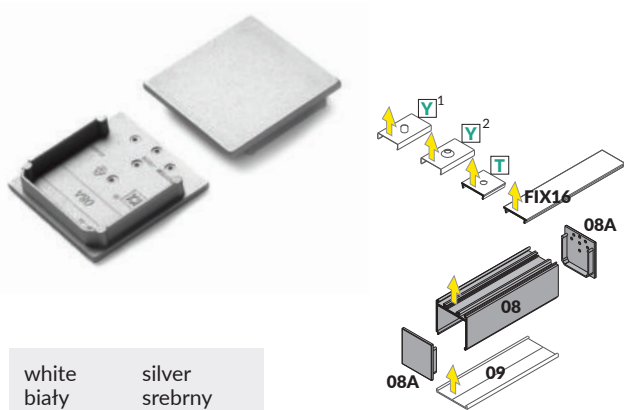

white	silver
biały	srebrny
weiß	silbern
blanc	argent
<b>V4940001</b>	<b>V4940040</b>
black	grey
czarny	szary
schwarz	grau
noir	gris
<b>V4940002</b>	<b>V4940022</b>

end cap VARIO30-08B For variants: 15, 24, 32  
 zaślepka VARIO30-08B Dla wariantów: 15, 24, 32  
 Endkappe VARIO30-08B Für Varianten: 15, 24, 32  
 embout VARIO30-08B Pour les variantes: 15, 24, 32

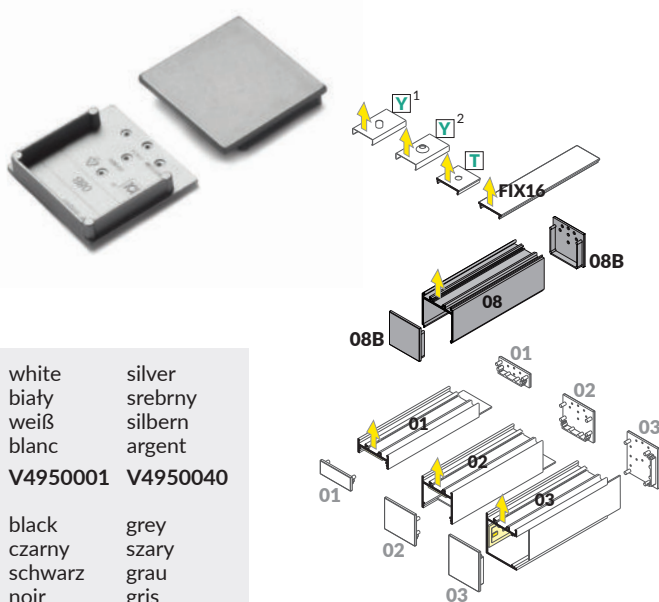

white	silver
biały	srebrny
weiß	silbern
blanc	argent
<b>V4950001</b>	<b>V4950040</b>
black	grey
czarny	szary
schwarz	grau
noir	gris
<b>V4950002</b>	<b>V4950022</b>

end cap VARIO30-08C For variants: 19, 27, 35  
 zaślepka VARIO30-08C Dla wariantów: 19, 27, 35  
 Endkappe VARIO30-08C Für Varianten: 19, 27, 35  
 embout VARIO30-08C Pour les variantes: 19, 27, 35

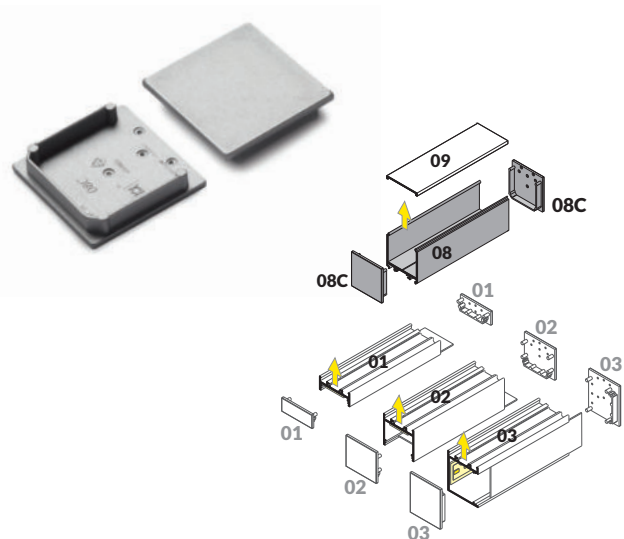

white	silver
biały	srebrny
weiß	silbern
blanc	argent
<b>V4960001</b>	<b>V4960040</b>
black	grey
czarny	szary
schwarz	grau
noir	gris
<b>V4960002</b>	<b>V4960022</b>

end cap VARIO30-08D For variants: 16, 17, 18, 25, 26, 34  
 zaślepka VARIO30-08D Dla wariantów: 16, 17, 18, 25, 26, 34  
 Endkappe VARIO30-08D Für Varianten: 16, 17, 18, 25, 26, 34  
 embout VARIO30-08D Pour les variantes: 16, 17, 18, 25, 26, 34

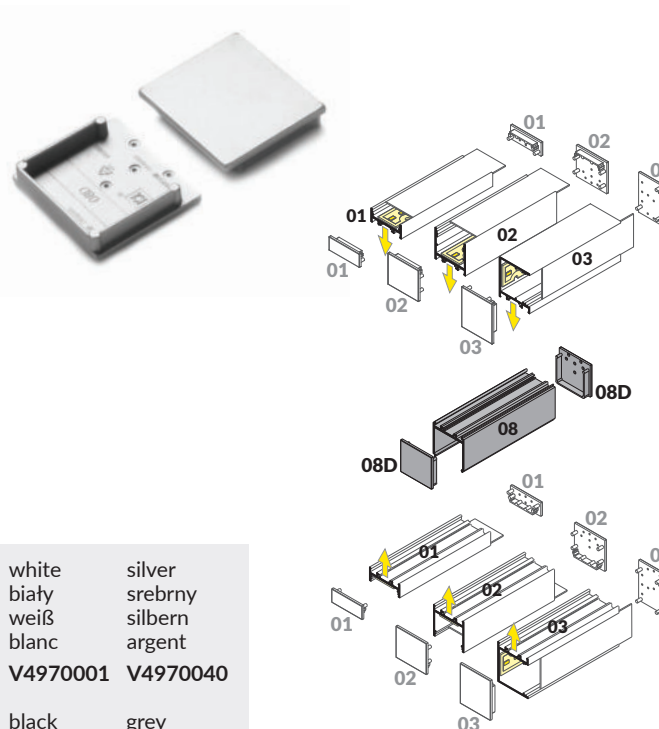

white	silver
biały	srebrny
weiß	silbern
blanc	argent
<b>V4970001</b>	<b>V4970040</b>
black	grey
czarny	szary
schwarz	grau
noir	gris
<b>V4970002</b>	<b>V4970022</b>

# METAL END CAPS MATERIAL: STEEL

# ZASLEPKI METALOWE MATERIAŁ: STAL

# METALLENDKAPPEN MATERIAL: STAHL

# EMBOUTS MÉTALLIQUES MATÉRIEL: ACIER

end cap VARIO30-16-E9 metal  
zaślepka VARIO30-16-E9 metal  
Endkappe VARIO30-16-E9 Metall  
embout VARIO30-16-E9 acier

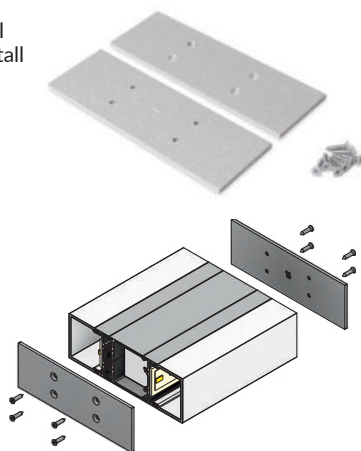

white biały weiß blanc	silver srebrny silbern argent
<b>V4550001S</b>	<b>V4550022S</b>
black czarny schwarz noir	
<b>V4550002S</b>	

end cap VARIO30-19-E9 metal  
zaślepka VARIO30-19-E9 metal  
Endkappe VARIO30-19-E9 Metall  
embout VARIO30-19-E9 metal

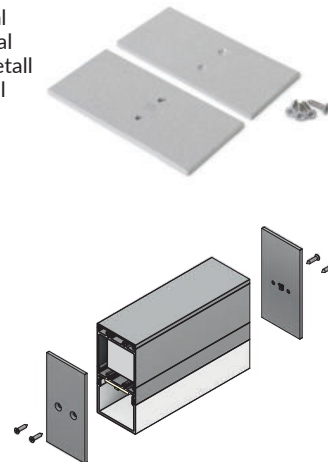

white biały weiß blanc	silver srebrny silbern argent
<b>V4560001S</b>	<b>V4560022S</b>
black czarny schwarz noir	
<b>V4560002S</b>	

end cap VARIO30-27 metal  
zaślepka VARIO30-27 metal  
Endkappe VARIO30-27 Metall  
embout VARIO30-27 metal

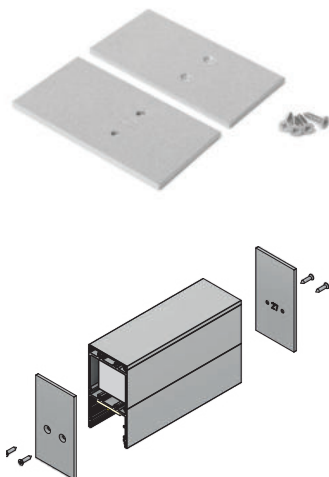

white biały weiß blanc	silver srebrny silbern argent
<b>V4570001S</b>	<b>V4570022S</b>
black czarny schwarz noir	
<b>V4570002S</b>	

end cap VARIO30-32 metal  
zaślepka VARIO30-32 metal  
Endkappe VARIO30-32 Metall  
embout VARIO30-32 metal

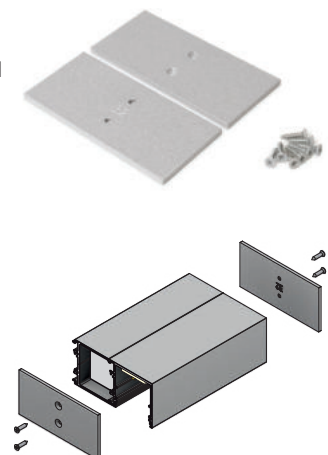

white biały weiß blanc	silver srebrny silbern argent
<b>V4580001S</b>	<b>V4580022S</b>
black czarny schwarz noir	
<b>V4580002S</b>	

end cap VARIO30-34 metal  
zaślepka VARIO30-34 metal  
Endkappe VARIO30-34 Metall  
embout VARIO30-34 metal

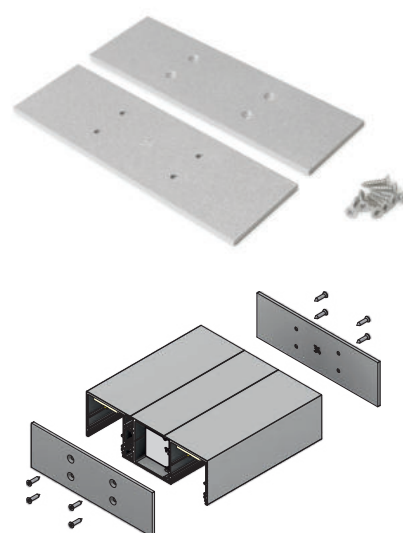

white biały weiß blanc	silver srebrny silbern argent
<b>V4590001S</b>	<b>V4590022S</b>
black czarny schwarz noir	
<b>V4590002S</b>	







# COMBO30



max 30 mm



surface  
nawierzchniowe  
Aufbauprofile  
surface



suspended  
zwieszane  
hängend  
suspendu



lighting  
oświetleniowe  
Beleuchtungs-  
éclairage d'ambiance

- multi-armed connections
- simplified installation and service
- for the construction of suspended and surface luminaires
- optional up&down lighting

- wieloramienne połączenia
- ułatwiony montaż i serwis
- do budowy opraw wiszących i powierzchniowych
- opcja świecenia góra/dół

- mehramige Verbindungen
- leichtere Montage und Service
- für den Bau von Hänge- und Aufbauleuchten
- optionale Up&Down-Beleuchtung

- connexions multibras
- montage et entretien plus faciles
- pour la construction de luminaires suspendus et de surface
- éclairage haut et bas en option



more  
information



więcej  
szczegółów



# COMBO30-01 ACDE-9

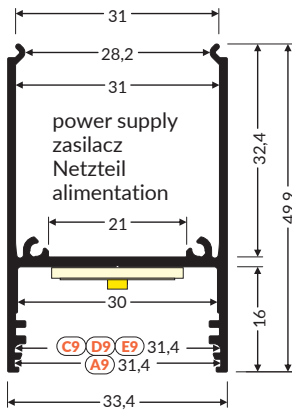

sling  
zawiesie  
Abhängung  
suspension  
→ 209

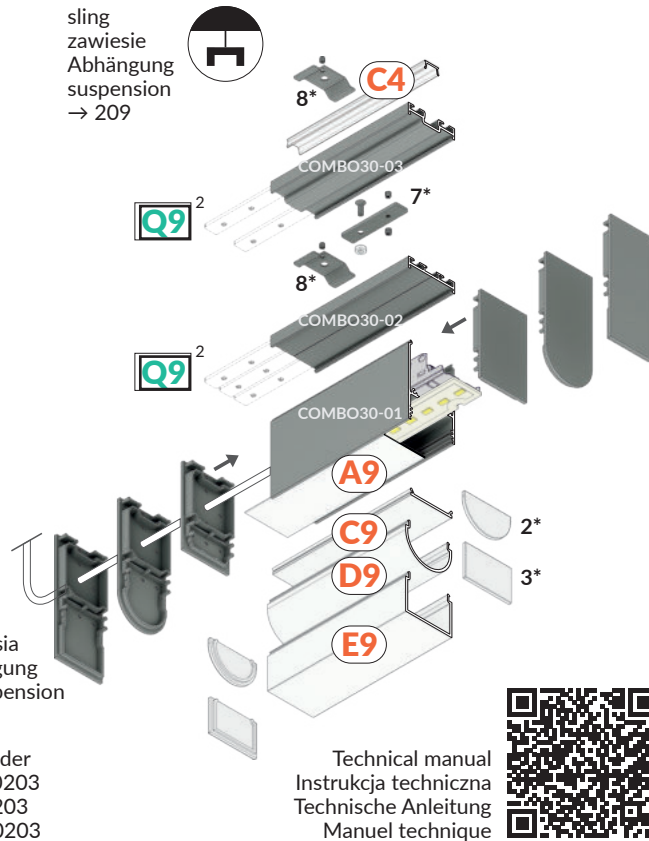

- 2\* → 198 end cap D9  
zaślepka D9  
Endkappe D9  
embout D9
- 7\* → 203 holder Q9 for sling  
uchwyt Q9 do zawiesia  
Halter Q9 für Abhängung  
fixation Q9 pour suspension
- 3\* → 199 end cap E9  
zaślepka E9  
Endkappe E9  
embout E9
- 8\* → 73 COMBO30-0203 holder  
uchwyt COMBO30-0203  
Halter COMBO30-0203  
fixation COMBO30-0203

- C4 → 196 diffuser C4 click  
klosz C4 klik  
Abdeckung C4 einclipsbar  
diffuseur C4 clic
- Q9<sup>1</sup> → 203 connector Q9 90 deg bent  
łącznik Q9 90 st gięty  
Verbinder Q9 90 Grad gebogen  
connecteur Q9 90 degrés suspendus
- Q9<sup>2</sup> → 203 connector Q9 180 deg  
łącznik Q9 180 st  
Verbinder Q9 180 Grad  
connecteur Q9 180 degrés
- Q9<sup>3</sup> → 203 connector Q9 135 deg  
łącznik Q9 135 st  
Verbinder Q9 135 Grad  
connecteur Q9 135 degrés
- Q9<sup>4</sup> → 203 connector Q9 120 deg  
łącznik Q9 120 st  
Verbinder Q9 120 Grad  
connecteur Q9 120 degrés
- Q9<sup>5</sup> → 203 connector Q9 90 deg  
łącznik Q9 90 st  
Verbinder Q9 90 Grad  
connecteur Q9 90 degrés
- Q9<sup>6</sup> → 203 connector Q9 60 deg  
łącznik Q9 60 st  
Verbinder Q9 60 Grad  
connecteur Q9 60 degrés
- Q9<sup>7</sup> → 203 connector Q9 45 deg  
łącznik Q9 45 st  
Verbinder Q9 45 Grad  
connecteur Q9 45 degrés

white painted biały malowany weiß lackiert peint en blanc	anodized anodowany eloxiert surface anodisée	black anodized czarny anodowany schwarz eloxiert noir anodisé	raw aluminium surowe aluminium Rohaluminium aluminium brut
1000 mm V6000101	V6000120	V6000121	V6000100
2000 mm V6000201	V6000220	V6000221	V6000200
3000 mm V6000301	V6000320	V6000321	V6000300
4050 mm V6000401	V6000420	V6000421	V6000400

end cap COMBO30-01A  
zaślepka COMBO30-01A  
Endkappe COMBO30-01A  
embout COMBO30-01A

end cap COMBO30-01A-D9  
zaślepka COMBO30-01A-D9  
Endkappe COMBO30-01A-D9  
embout COMBO30-01A-D9

end cap COMBO30-01A-E9  
zaślepka COMBO30-01A-E9  
Endkappe COMBO30-01A-E9  
embout COMBO30-01A-E9

A9 → 194 diffuser A9 slide  
klosz A9 wsuwany  
Abdeckung A9 einschiebbar  
diffuseur A9 coulissant

white biały weiß blanc	silver srebrny silbern argent
V6998901	V6998940

white biały weiß blanc	silver srebrny silbern argent
V6999001	V6999040

white biały weiß blanc	silver srebrny silbern argent
V6999101	V6999140

C9 → 197 diffuser C9 click  
klosz C9 klik  
Abdeckung C9 einclipsbar  
diffuseur C9 clic

black czarny schwarz noir	grey szary grau gris
V6998902	V6998922

black czarny schwarz noir	grey szary grau gris
V6999002	V6999022

black czarny schwarz noir	grey szary grau gris
V6999102	V6999122

D9 → 198 diffuser D9 click  
klosz D9 klik  
Abdeckung D9 einclipsbar  
diffuseur D9 clic

E9 → 199 diffuser E9 click  
klosz E9 klik  
Abdeckung E9 einclipsbar  
diffuseur E9 clic

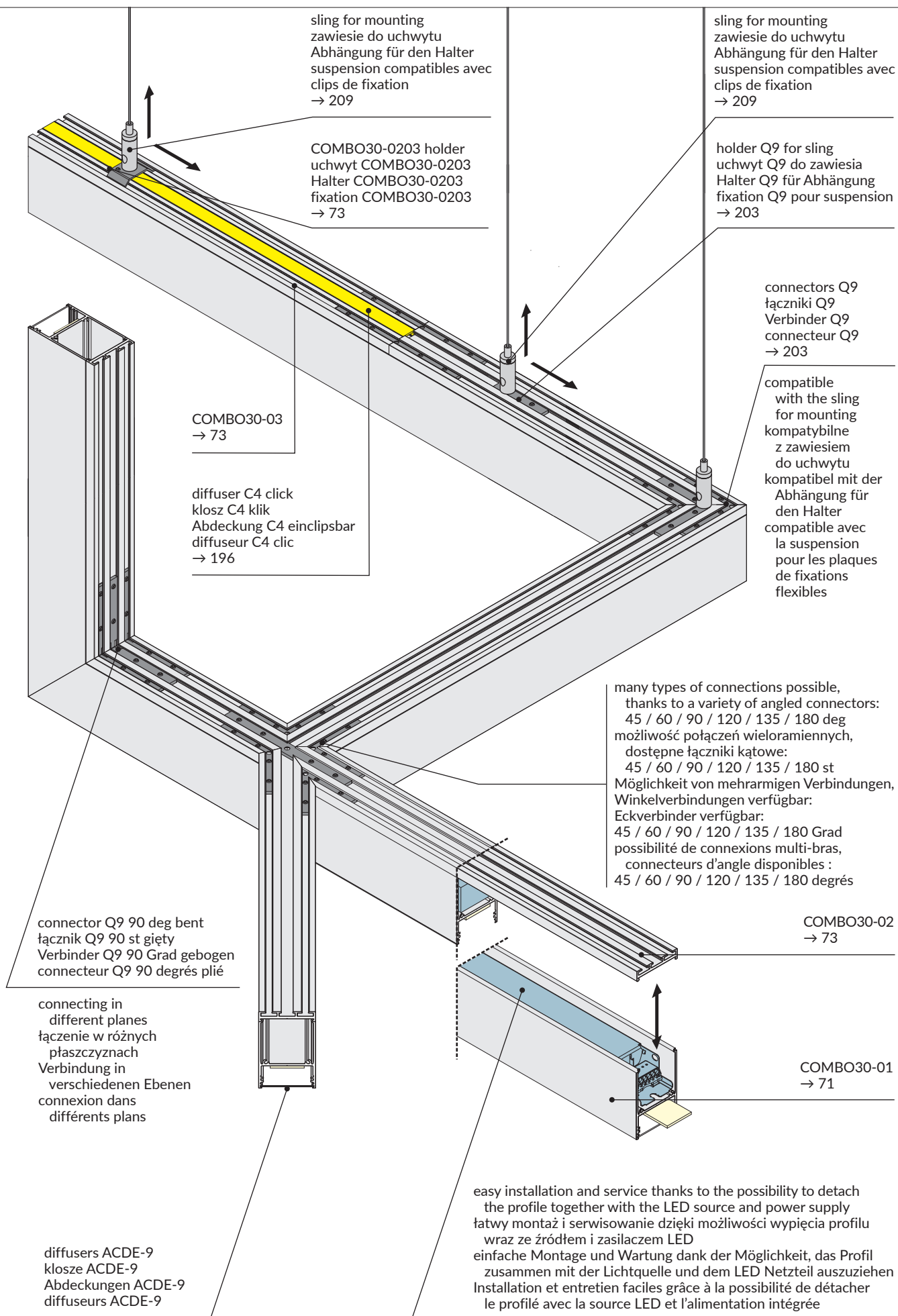

COMPLEMENTARY PROFILE COMBO30-02  
 PROFIL UZUPEŁNIAJĄCY COMBO30-02  
 ERGÄNZUNGSPROFIL COMBO30-02  
 PROFILÉ COMPLÉMENTAIRE COMBO30-02

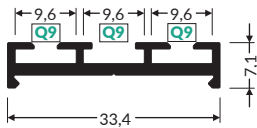

white painted  
biały malowany  
weiß lackiert  
peint en blanc



anodized  
anodowany  
eloxiert  
surface anodisée



black anodized  
czarny anodowany  
schwarz eloxiert  
noir anodisé



raw aluminium  
surowe aluminium  
Rohaluminium  
aluminium brut

1000 mm	V6000501	V6000520	V6000521	V6000500
2000 mm	V6000601	V6000620	V6000621	V6000600
3000 mm	V6000701	V6000720	V6000721	V6000700
4050 mm	V6000801	V6000820	V6000821	V6000800

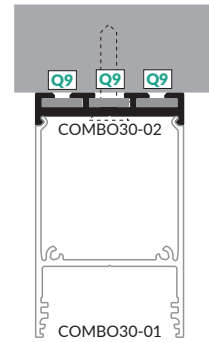
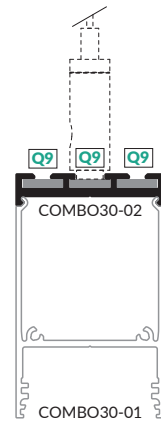

COMPLEMENTARY PROFILE COMBO30-03  
 PROFIL UZUPEŁNIAJĄCY COMBO30-03  
 ERGÄNZUNGSPROFIL COMBO30-03  
 PROFILÉ COMPLÉMENTAIRE COMBO30-03

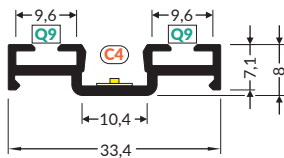

white painted  
biały malowany  
weiß lackiert  
peint en blanc



anodized  
anodowany  
eloxiert  
surface anodisée

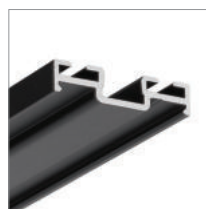

black anodized  
czarny anodowany  
schwarz eloxiert  
noir anodisé



raw aluminium  
surowe aluminium  
Rohaluminium  
aluminium brut

1000 mm	V6000901	V6000920	V6000921	V6000900
2000 mm	V6001001	V6001020	V6001021	V6001000
3000 mm	V6001101	V6001120	V6001121	V6001100
4050 mm	V6001201	V6001220	V6001221	V6001200

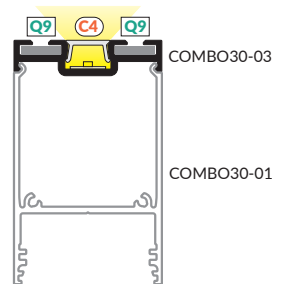
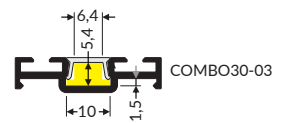

holder COMBO30-0203  
 uchwyt COMBO30-0203  
 Halter COMBO30-0203  
 fixation COMBO30-0203

material: stainless steel  
 materiał: stal nierdzewna  
 Material: rostfreier Stahl  
 matériel: acier inoxydable

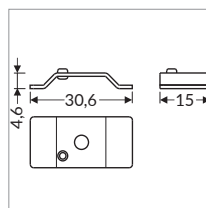

inox  
 V5998719

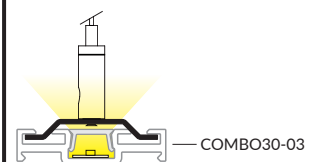
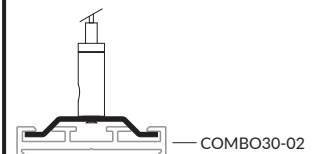



# MANY OPTIONS OF ANGULAR CONNECTIONS WIELE MOŻLIWOŚCI POŁĄCZEŃ KĄTOWYCH VIELE MÖGLICHKEITEN DER ECKVERBINDUNGEN DE NOMBREUSES POSSIBILITÉS DE CONNEXIONS ANGULAIRES



The system of connectors and sockets in the profile allows the creation of stable multi-armed connections and the use of slings in the place of profile connections  
System łączników i gniazd w profilu pozwala na tworzenie stabilnych połączeń wieloramiennych oraz na użycie zawieszia w miejscu łączenia profili  
Das System von Verbindungen und Sockeln im Profil ermöglicht die Schaffung stabiler mehrarmiger Verbindungen und die Verwendung von Abhängung an der Stelle der Profilverbindung  
Le système de connecteurs et de prises dans le profilé permet la création de connexions multi-bras stables et l'utilisation d'un kit de suspensions dans les endroits de connexion des profilés



Connectors used in the example:  
Łączniki użyte w przykładzie:  
Die im Beispiel verwendeten Verbindungen:  
Connecteurs utilisés dans l'exemple:

connector Q9 135 deg  
łącznik Q9 135 st  
Verbinder Q9 135 Grad  
connecteur Q9 135 degrés

connector Q9 45 deg  
łącznik Q9 45 st  
Verbinder Q9 45 Grad  
connecteur Q9 45 degrés

connector Q9 180 deg (x2)  
łącznik Q9 180 st (x2)  
Verbinder Q9 180 Grad (x2)  
connecteur Q9 1805 degrés (x2)

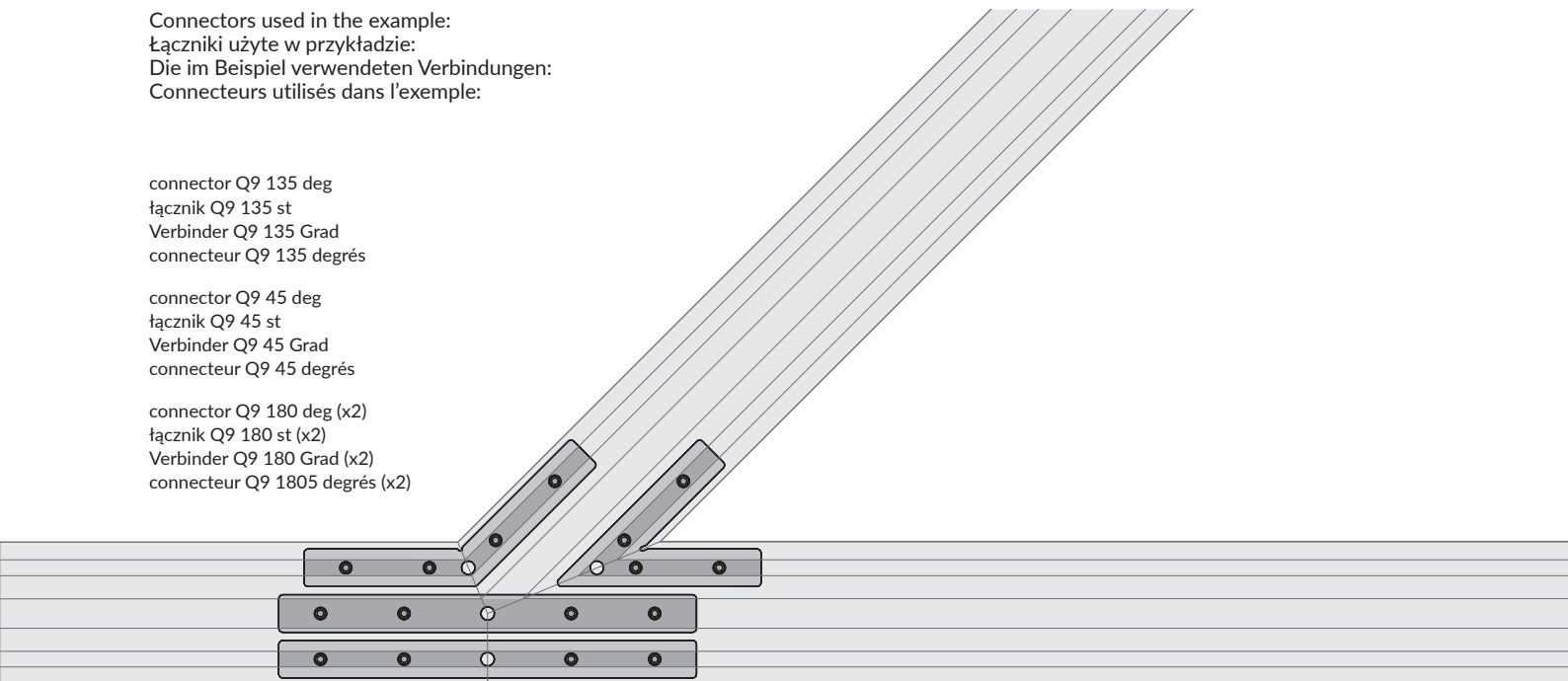

# NAMI23 CD-9



max 23 mm



suspended  
zwieszane  
hängend  
suspendu



lighting  
oświetleniowe  
Beleuchtungs-  
éclairage d'ambiance

- for the construction of suspended LED luminaires
- unique aesthetics, new design
- minimalist and refined details
- convenient mounting and service – clip-on profile for LED source
- space for the power supply inside the luminaire
- designed for painting

- do budowy wiszących opraw LED
- wyjątkowa estetyka, świeże wzornictwo
- minimalistyczne i dopracowane detale
- wygodny montaż i serwis – wkłikiwany profil na źródło LED
- miejsce na zasilacz wewnątrz oprawy
- przeznaczony pod malowanie

- für den Bau der hängenden LED Leuchten
- einmalige Ästhetik, frisches Design
- minimalistische und auserlesene Details
- bequeme Montage und Service - einklickbares Profil für LED-Lichtquelle
- Platz für Speiseleitung innerhalb der Leuchte
- bestimmt fürs Anstreichen

- pour construction des luminaires LED suspendus
- esthétique unique, design frais
- détails minimalistes et raffinés
- installation et service pratiques – profil à cliquer pour la source LED
- espace pour intégrer alimentation à l'intérieur du luminaire
- destiné à la peinture



more  
information



więcej  
szczegółów

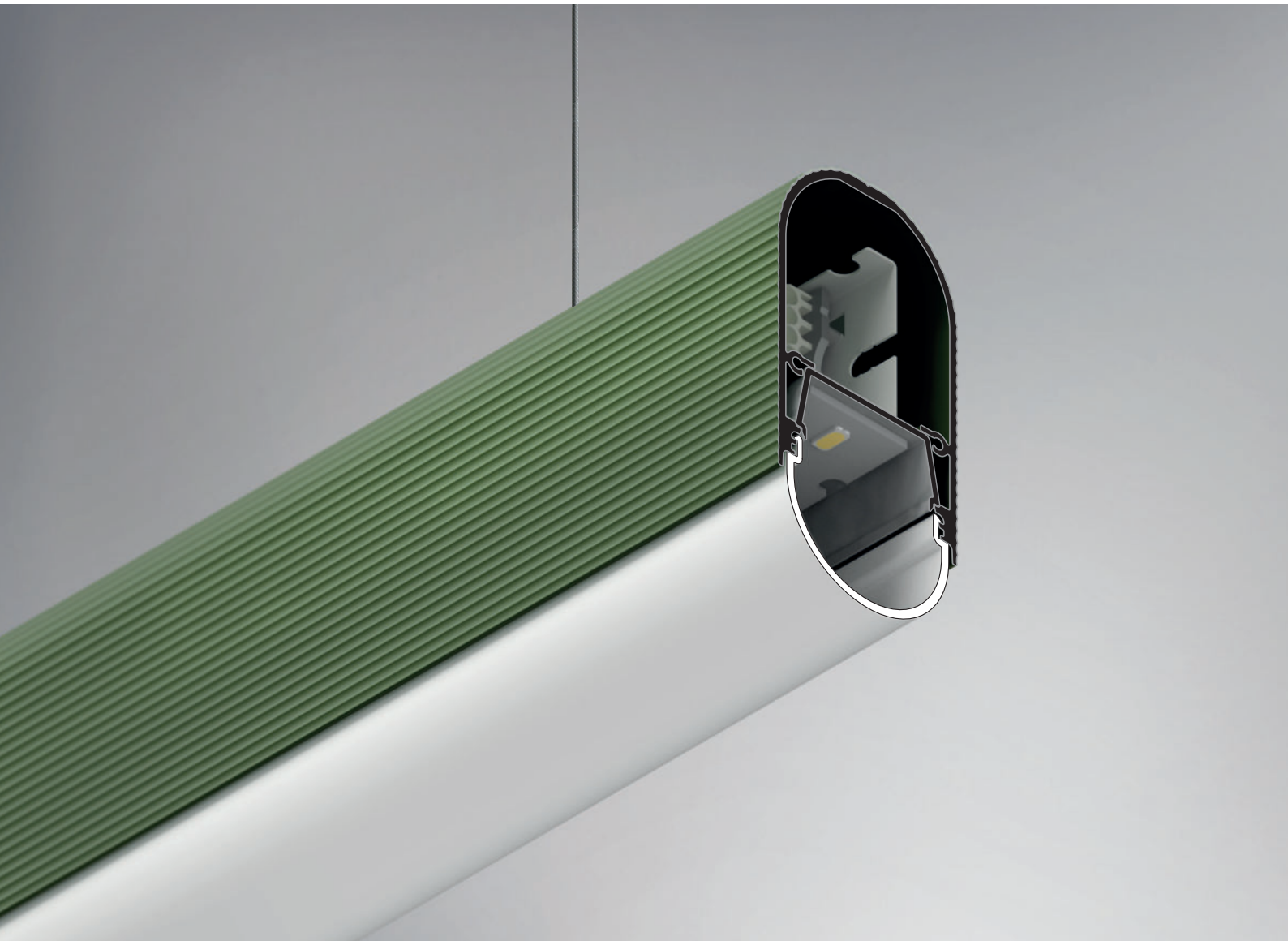

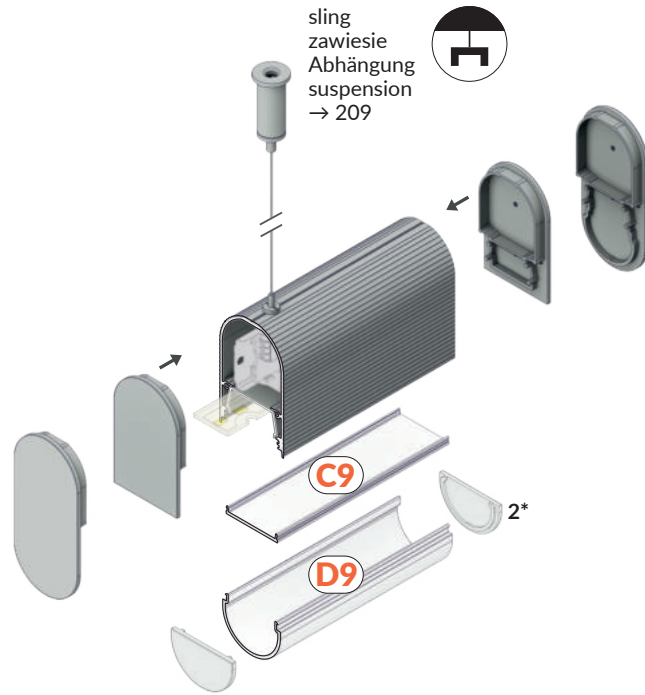
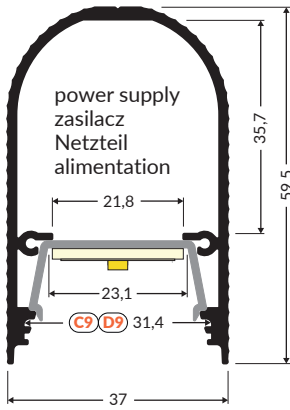

**C9** → 197

diffuser C9 click  
klosz C9 klik  
Abdeckung C9 einclipsbar  
diffuseur C9 clic

**D9** → 198

diffuser D9 click  
klosz D9 klik  
Abdeckung D9 einclipsbar  
diffuseur D9 clic

**2\*** → 198

end cap D9  
zaślepka D9  
Endkappe D9  
embout D9

LED profile NAMI23  
profil LED NAMI23  
LED profile NAMI23  
profilé LED NAMI23

complementary profile NAMI23  
profil uzupełniający NAMI23  
Ergänzungsprofil NAMI23  
profilé complémentaire NAMI23



raw aluminium  
surowe aluminium  
Rohaluminium  
aluminium brut



anodized  
anodowany  
eloxiert  
surface anodisée

1000 mm	<b>K1000100</b>	<b>K1000520</b>
2000 mm	<b>K1000200</b>	<b>K1000620</b>
3000 mm	<b>K1000300</b>	<b>K1000720</b>
4050 mm	<b>K1000400</b>	<b>K1000820</b>

end cap NAMI23  
zaślepka NAMI23  
Endkappe NAMI23  
embout NAMI23



grey  
szary  
grau  
gris  
**K1999822**

end cap NAMI23-D9  
zaślepka NAMI23-D9  
Endkappe NAMI23-D9  
embout NAMI23-D9



grey  
szary  
grau  
gris  
**K1999922**





# LOWI C10



max 42 mm



surface  
nawierzchniowe  
Aufbauprofile  
surface



suspended  
zwieszane  
hängend  
suspendu



lighting  
oświetleniowe  
Beleuchtungs-  
éclairage d'ambiance

- profile for creating LED luminaires
- perfect as main lighting
- 3 types of covers available with different light distributions

- profil do tworzenia opraw oświetleniowych
- doskonały jako oświetlenie główne
- dostępne 3 rodzaje kloszy o różnych rozsyłach światła

- Profile für die Erstellung von LED-Leuchten
- perfekt als Hauptbeleuchtung
- 3 Arten von Abdeckungen mit unterschiedlichen Lichtverteilungen verfügbar

- les profilés pour la création de luminaires LED
- un éclairage principal optimal
- 3 types de diffuseurs sont proposés avec des répartitions de la lumière différentes



more  
information



więcej  
szczegółów

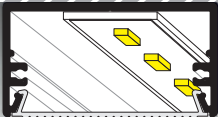

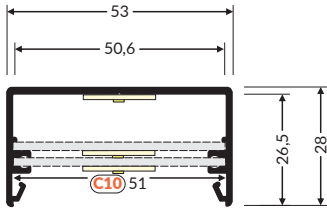

sling  
zawiesz  
Abhängung  
suspension  
→ 209

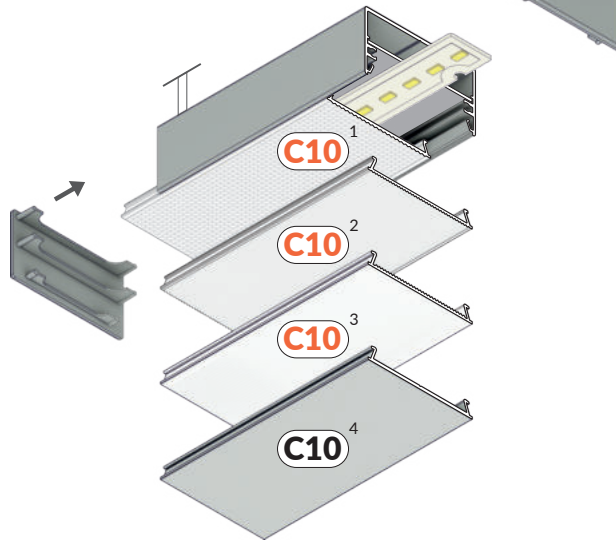

### C10<sup>1</sup> → 197

diffuser C10 click OPAL  
klosz C10 klik OPAL  
Abdeckung C10  
einclipsbar OPAL  
diffuseur C10 clic OPAL

### C10<sup>2</sup> → 197

diffuser C10 click NARROW  
klosz C10 klik NARROW  
Abdeckung C10  
einclipsbar NARROW  
diffuseur C10 clic NARROW

### C10<sup>3</sup> → 197

diffuser C10 click WIDE  
klosz C10 klik WIDE  
Abdeckung C10  
einclipsbar WIDE  
diffuseur C10 clic WIDE

end cap LOWI  
zaślepka LOWI  
Endkappe LOWI  
embout LOWI



white painted  
biały malowany  
weiß lackiert  
peint en blanc



anodized  
anodowany  
eloxiert  
surface anodisée



black painted  
czarny malowany  
schwarz lackiert  
peint en noir



raw aluminium  
surowe aluminium  
Rohaluminium  
aluminium brut

1000 mm	93020001	93020020	93020002	93020000
2000 mm	93030001	93030020	93030002	93030000
3000 mm	93090001	93090020	93090002	93090000
4050 mm	93100001	93100020	93100002	93100000

white biały weiß blanc	silver srebrny silbern argent
93066001	93070040
black czarny schwarz noir	grey szary grau gris
93070002	93070022

### C10<sup>4</sup>

cover C10  
ośłona C10  
Abdeckplatte C10  
cache C10



white painted  
biały malowany  
weiß lackiert  
peint en blanc



anodized  
anodowany  
eloxiert  
surface anodisée



black painted  
czarny malowany  
schwarz lackiert  
peint en noir



raw aluminium  
surowe aluminium  
Rohaluminium  
aluminium brut

1000 mm	63550001	63550020	63550002	63550000
2000 mm	63560001	63560020	63560002	63560000
3000 mm	63740001	63740020	63740002	63740000
4050 mm	63750001	63750020	63750002	63750000

LED mounting 50  
mocowanie LED 50  
Montageteil LED 50  
fixation LED 50

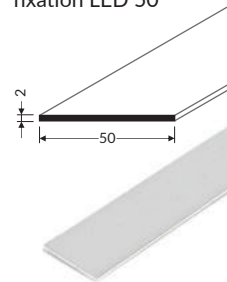

raw aluminium surowe aluminium Rohaluminium aluminium brut
25080000
25090000
25170000
25180000

# PHIL53 C10



max 46 mm



surface  
nawierzchniowe  
Aufbauprofile  
surface



suspended  
zwieszane  
hängend  
suspendu



lighting  
oświetleniowe  
Beleuchtungs-  
éclairage d'ambiance

- profile for creating LED luminaires
- perfect as main lighting
- various installation options
- larger sizes
- 3 types of covers available with different light distributions
- enables hiding the power supply inside the profile

- profil do tworzenia opraw LED
- doskonały jako oświetlenie główne
- różnorodne opcje montażu
- większe gabaryty
- dostępne 3 rodzaje kloszy o różnych rozsyłach światła
- umożliwia ukrycie zasilacza wewnątrz profilu

- Profile für die Erstellung von LED Leuchten
- perfekt als Hauptbeleuchtung
- verschiedene Montageoptionen
- größere Baumasse
- 3 Arten von Abdeckungen mit unterschiedlichen Lichtverteilungen verfügbar
- ermöglicht das Verstecken des Netzteils innerhalb des Profils

- le profilé pour la création de luminaires LED
- un éclairage principal optimal
- les différentes options de montage - de suspension à encastrer
- les plus grandes dimensions
- 3 types de diffuseurs sont proposés avec des répartitions de la lumière différentes
- nos produits permettent de dissimuler le bloc d'alimentation à l'intérieur du profilé



more  
information



więcej  
szczegółów

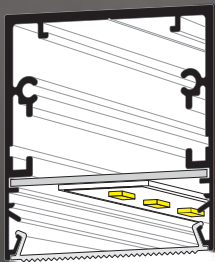

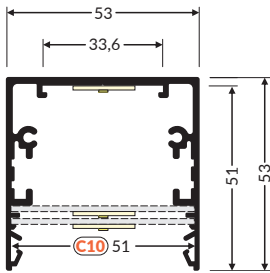

sling  
zawiesz  
Abhängung  
suspension  
→ 209

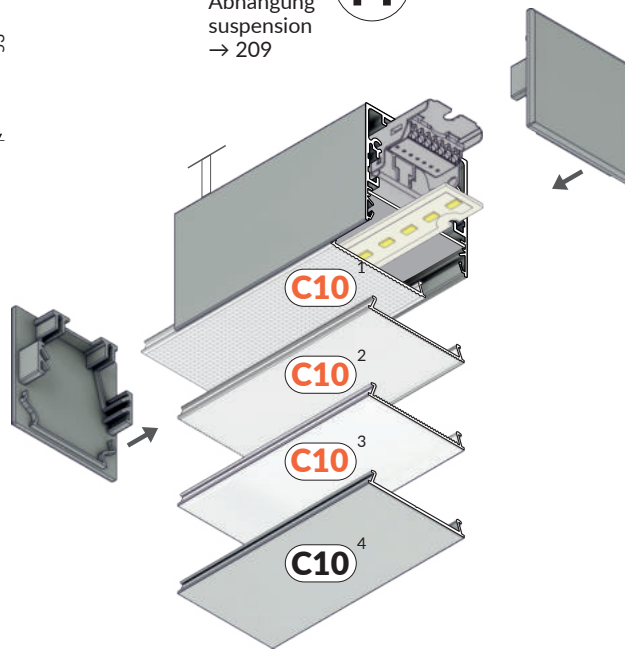

**C10**<sup>1</sup> → 197

diffuser C10 click OPAL  
klosz C10 klik OPAL  
Abdeckung C10  
einclipsbar OPAL  
diffuseur C10 clic OPAL

**C10**<sup>2</sup> → 197

diffuser C10 click NARROW  
klosz C10 klik NARROW  
Abdeckung C10  
einclipsbar NARROW  
diffuseur C10 clic NARROW

**C10**<sup>3</sup> → 197

diffuser C10 click WIDE  
klosz C10 klik WIDE  
Abdeckung C10  
einclipsbar WIDE  
diffuseur C10 clic WIDE

end cap PHIL53  
zaślepka PHIL53  
Endkappe PHIL53  
embout PHIL53

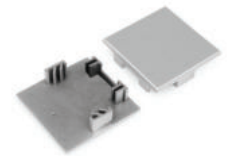

white painted  
biały malowany  
weiß lackiert  
peint en blanc



anodized  
anodowany  
eloxiert  
surface anodisée

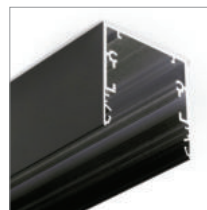

black painted  
czarny malowany  
schwarz lackiert  
peint en noir

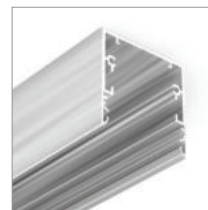

raw aluminium  
surowe aluminium  
Rohaluminium  
aluminium brut

1000 mm	<b>63520001</b>	<b>63520020</b>	<b>63520002</b>	<b>63520000</b>
2000 mm	<b>63530001</b>	<b>63530020</b>	<b>63530002</b>	<b>63530000</b>
3000 mm	<b>63720001</b>	<b>63720020</b>	<b>63720002</b>	<b>63720000</b>
4050 mm	<b>63730001</b>	<b>63730020</b>	<b>63730002</b>	<b>63730000</b>

white      silver  
biały      srebrny  
weiß      silberny  
blanc      argent

**63640001**    **63640040**

black      grey  
czarny      szary  
schwarz      grau  
noir      gris

**63640002**    **63640022**

**C10**<sup>4</sup>

cover C10  
osłona C10  
Abdeckplatte C10  
cache C10



white painted  
biały malowany  
weiß lackiert  
peint en blanc



anodized  
anodowany  
eloxiert  
surface anodisée



black painted  
czarny malowany  
schwarz lackiert  
peint en noir



raw aluminium  
surowe aluminium  
Rohaluminium  
aluminium brut

1000 mm	<b>63550001</b>	<b>63550020</b>	<b>63550002</b>	<b>63550000</b>
2000 mm	<b>63560001</b>	<b>63560020</b>	<b>63560002</b>	<b>63560000</b>
3000 mm	<b>63740001</b>	<b>63740020</b>	<b>63740002</b>	<b>63740000</b>
4050 mm	<b>63750001</b>	<b>63750020</b>	<b>63750002</b>	<b>63750000</b>

LED mounting 50  
mocowanie LED 50  
Montageteil LED 50  
fixation LED 50

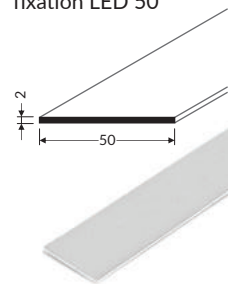

raw aluminium  
surowe aluminium  
Rohaluminium  
aluminium brut

<b>25080000</b>
<b>25090000</b>
<b>25170000</b>
<b>25180000</b>







**RECESSED  
WPUSTOWE  
EINBAUPROFIL  
A ENCASTRER**



# SLASH8



max 8 mm



recessed  
wpustowy  
Einbauprofile  
encastrés



furniture  
meblowe  
Möbel-  
mobilier

- easy installation of the LED strip
- installation in a small gap 5x14 mm
- possibility of installation in an arc (minimum bend cap radius 25 cm)
- continuous line of light when

- łatwy montaż taśmy LED
- montaż w niewielkiej szczelinie 5x14 mm
- możliwość montażu po łuku (minimalny promień gięcia 25 cm)
- ciągła linia światła przy użyciu taśmy LED 120 P/m

- einfache Montage des LED Streifens
- Montage in einem kleinen Spalt 5x14 mm
- Möglichkeit der Montage nach einem Bogen (Mindestbiegeradius 25 cm)
- eine homogene Lichtlinie (bei Anwendung von LED Streifen mit 120 leds/m)

- installation facile du ruban LED
- installation dans un petit espace de 5x14 mm
- possibilité d'installation en arc (rayon de courbure minimum 25 cm)
- ligne continue de lumière en utilisant un ruban LED 120 P/M.



more  
information



więcej  
szczegółów



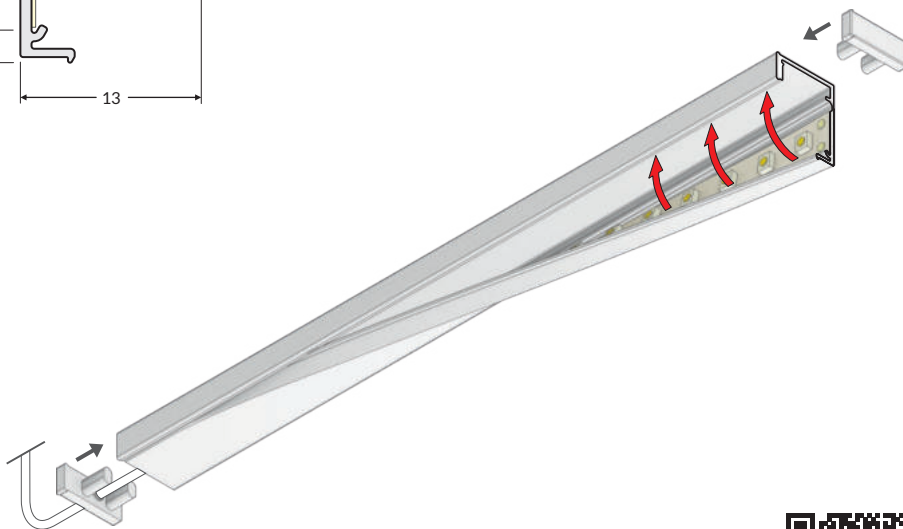
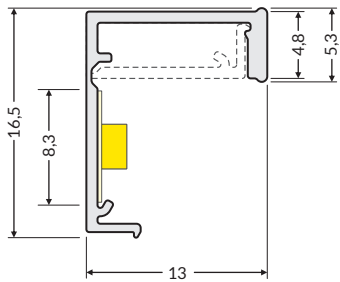

Technical manual  
Instrukcja techniczna  
Technische Anleitung  
Manuel technique



material: PC opal  
material: PC mleczny  
Material: PC opal  
matériel: PC opaque

1000 mm	<b>G5000120</b>
2000 mm	<b>G5000220</b>
3000 mm	<b>G5000320</b>
4100 mm	<b>G5000420</b>

end cap SLASH8  
zaślepka SLASH8  
Endkappe SLASH8  
embout SLASH8



opal  
mleczny  
opal  
opaque  
**G5999922**





# HI8 C1



max 8 mm



recessed  
wpustowy  
Einbauprofile  
encastrés



furniture  
meblowe  
Möbel-  
mobilier

- decorative illumination
- for counter edges, steps
- flushes with mounting surface
- only enlight surface of the diffuser is visible
- miniature dimensions

- oświetlenie dekoracyjne
- do montażu w krawędzi blatów, stopni
- zlicowany z powierzchnią montażową
- widoczna tylko świecąca powierzchnia klosza
- miniaturowe gabaryty

- dekorative Beleuchtung
- für die Montage am Rand von Platten, Stufen
- mit der Montagefläche gepasst
- sichtbar ist nur die leuchtende Oberfläche der Abdeckung
- Miniaturbaumasse

- éclairage décoratif
- pour l'installation dans le bord des comptoirs, des marches
- affleure la surface de montage
- seule la surface lumineuse du diffuseur est visible
- dimensions miniatures



more  
information



więcej  
szczegółów



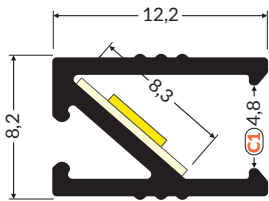

Technical manual  
Instrukcja techniczna  
Technische Anleitung  
Manuel technique



**C1** → 195

diffuser C1 click  
klosz C1 klik  
Abdeckung C1 einclipsbar  
diffuseur C1 clic

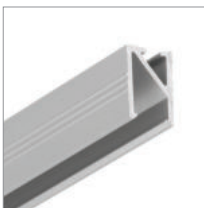

anodized  
anodowany  
eloxiert  
surface anodisée

1000 mm	<b>H8010020</b>
2000 mm	<b>H8020020</b>
3000 mm	<b>H8030020</b>
4050 mm	<b>H8040020</b>

end cap HI8  
zaślepka HI8  
Endkappe HI8  
embout HI8



silver	grey
srebrny	szary
silbern	grau
argent	gris
<b>H8990040</b>	<b>H8990022</b>

opal  
mleczny  
opal  
opaque  
**H8990038**







max 10 mm



recessed  
wpustowy  
Einbauprofile  
encastrés



furniture  
meblowe  
Möbel-  
mobilier

- suitable for use in plasterboards - does not affect the structure of the board
- used also in furniture
- continuous line of light (when using LED strip 120 p/m and opal diffuser)
- Slick socket
- miniature dimensions

- do zastosowania w płycie gipsowo-kartonowej - nie narusza konstrukcji płyty
- również do zastosowania meblowego
- ciągła linia światła (przy zastosowaniu taśmy 120 P/m i klosza mlecznego)
- gniazdo z funkcją Slick
- miniaturowe gabaryty

- für die Anwendung in einer Rigipsplatte - es beeinträchtigt die Struktur der Platte nicht
- auch für die Möbelanwendung
- eine homogene Lichtlinie (unter Verwendung von LED Streifen mit 120 leds/m und einer opalen Abdeckung)
- Sockel mit Slick Funktion
- Miniaturbaumasse

- pour une utilisation dans les plaques de plâtre - cela n'affecte pas la structure de la plaque
- aussi pour les les mobiliers
- une ligne continue de lumière (en utilisant un ruban 120 P/M. et un diffuseur opaque)
- prise avec fonction Slick
- dimensions miniatures



more  
information



więcej  
szczegółów



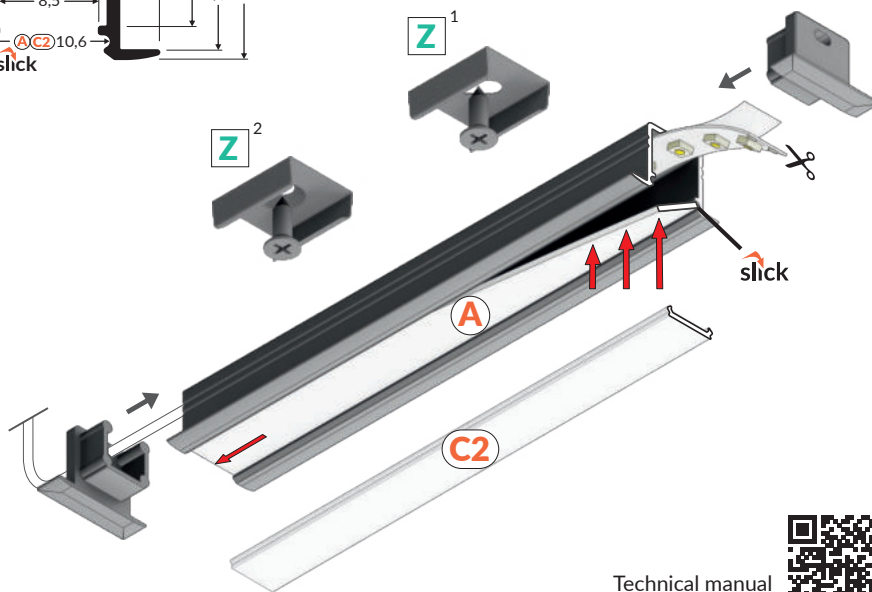
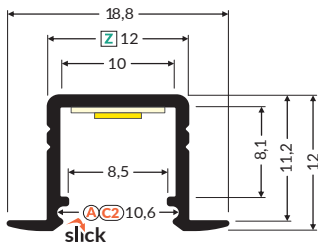

Technical manual  
Instrukcja techniczna  
Technische Anleitung  
Manuel technique



**Z<sup>1</sup>** → 208

mounting plate Z  
uchwyt Z  
Halter Z  
fixation Z

**Z<sup>2</sup>** → 208

mounting plate Z cone  
uchwyt Z cone  
Halter Z cone  
fixation Z cône

**A** → 194

diffuser A slide  
klosz A wsuwany  
Abdeckung A einschiebbar  
diffuseur A coulissant

**C2** → 196

diffuser C2 click  
klosz C2 klik  
Abdeckung C2 einclipsbar  
diffuseur C2 clic



white painted  
biały malowany  
weiß lackiert  
peint en blanc

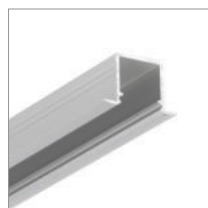

anodized  
anodowany  
eloxiert  
surface anodisée



black anodized  
czarny anodowany  
schwarz eloxiert  
noir anodisé



raw aluminium  
surowe aluminium  
Rohaluminium  
aluminium brut

1000 mm	<b>E3010001</b>	<b>E3010020</b>	<b>E3010021</b>	<b>E3010000</b>
2000 mm	<b>E3020001</b>	<b>E3020020</b>	<b>E3020021</b>	<b>E3020000</b>
3000 mm	<b>E3030001</b>	<b>E3030020</b>	<b>E3030021</b>	<b>E3030000</b>
4050 mm	<b>E3040001</b>	<b>E3040020</b>	<b>E3040021</b>	<b>E3040000</b>

end cap SMART-IN10 with hole  
zaślepka SMART-IN10 z otworem  
Endkappe SMART-IN10 mit Öffnung  
embout SMART-IN10 avec un trou



white      silver  
biały     srebrny  
weiß     silbern  
blanc    argent  
**E3990001** **E3990040**

black      grey  
czarny   szary  
schwarz   grau  
noir     gris  
**E3990002** **E3990022**



# BEGTIN12 J/S



max 12 mm



recessed  
wpustowy  
Einbauprofile  
encastrés



furniture  
mebłowe  
Möbel-  
mobilier

- light weight, budget profile
- used mainly in furniture
- Slick socket

- lekki profil budżetowy
- głównie do zastosowania meblowego
- Gniazdo z funkcją Slick

- ein leichtes Budget-Profil
- hauptsächlich für die Möbelanwendung
- Sockel mit Slick Funktion

- profilé à prix bas, léger
- principalement pour les mobiliers
- prise avec fonction Slick



more  
information



więcej  
szczegółów



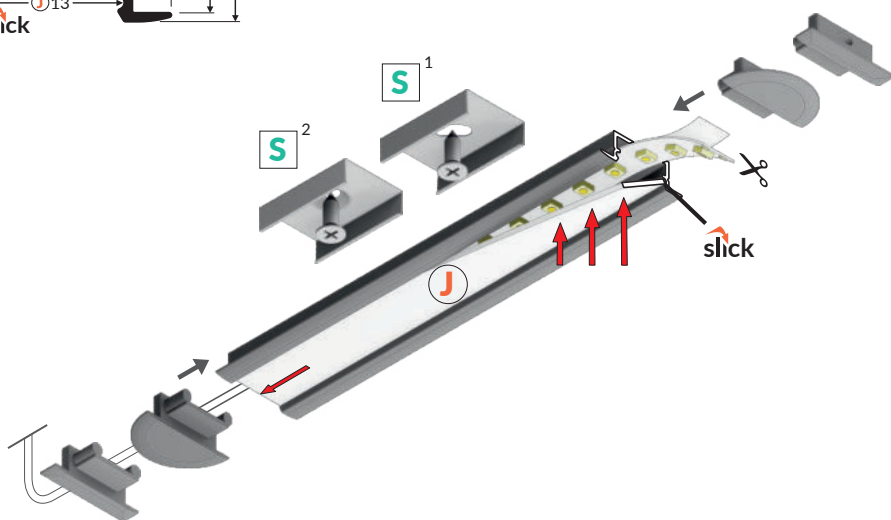
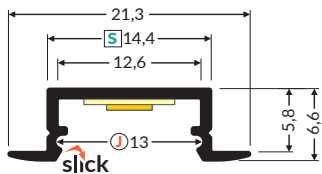

**S**<sup>1</sup> → 204

mounting plate S  
uchwyt S  
Halter S  
fixation S

**S**<sup>2</sup> → 204

mounting plate S cone  
uchwyt S cone  
Halter S cone  
fixation S cône

**J** → 200

diffuser J slide  
klosz J wsuwany  
Abdeckung J einziehbar  
diffuseur J coulissant

Technical manual  
Instrukcja techniczna  
Technische Anleitung  
Manuel technique



white painted  
biały malowany  
weiß lackiert  
peint en blanc



anodized  
anodowany  
eloxiert  
surface anodisée



black anodized  
czarny anodowany  
schwarz eloxiert  
noir anodisé



raw aluminium  
surowe aluminium  
Rohaluminium  
aluminium brut

1000 mm	<b>C8010001</b>	<b>C8010020</b>	<b>C8010021</b>	<b>C8010000</b>
2000 mm	<b>C8020001</b>	<b>C8020020</b>	<b>C8020021</b>	<b>C8020000</b>
3000 mm	<b>C8030001</b>	<b>C8030020</b>	<b>C8030021</b>	<b>C8030000</b>
4050 mm	<b>C8040001</b>	<b>C8040020</b>	<b>C8040021</b>	<b>C8040000</b>

end cap BEGTIN12 gen2 with hole  
zaślepka BEGTIN12 gen2 z otworem  
Endkappe BEGTIN12 gen2 mit Öffnung  
embout BEGTIN12 gen2 avec un trou



white  
biały  
weiß  
blanc  
**C8980001**

silver  
srebrny  
silbern  
argent  
**C8980040**

black  
czarny  
schwarz  
noir  
**C8980002**

grey  
szary  
grau  
gris  
**C8980022**

end cap BEGTIN12 gen2 SQ with hole  
zaślepka BEGTIN12 gen2 SQ z otworem  
Endkappe BEGTIN12 gen2 SQ mit Öffnung  
embout BEGTIN12 gen2 SQ avec un trou



white  
biały  
weiß  
blanc  
**C8970001**

silver  
srebrny  
silbern  
argent  
**C8970040**

black  
czarny  
schwarz  
noir  
**C8970002**

grey  
szary  
grau  
gris  
**C8970022**





# GROOVE10 BC/UX



- used mainly in furniture
- ceiling installation possible
- 7 types of diffusers

- głównie do zastosowania meblowego
- możliwe zastosowanie sufitowe
- 7 rodzajów kloszy

- hauptsächlich für Möbelbereich
- möglich ist auch die Anwendung an der Decke
- 7 Abdeckungen zur Wahl

- principalement pour les mobiliers
- application possible au plafond
- 7 types de diffuseurs



more  
information



więcej  
szczegółów

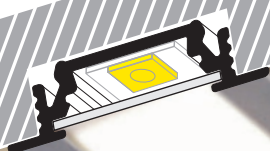

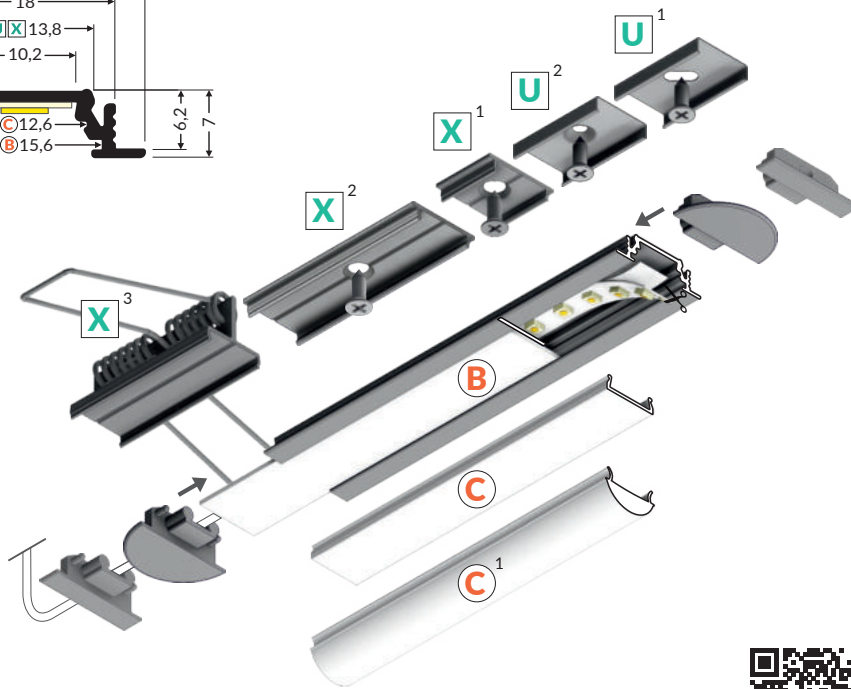
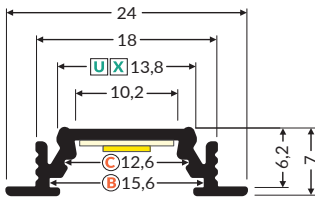

Technical manual  
Instrukcja techniczna  
Technische Anleitung  
Manuel technique



**U**<sup>1</sup> → 204

mounting plate U  
uchwyt U  
Halter U  
fixation U

**U**<sup>2</sup> → 204

mounting plate U cone  
uchwyt U cone  
Halter U cone  
fixation U cône

**X**<sup>1</sup> → 207

mounting plate X  
uchwyt X  
Halter X  
fixation X

**X**<sup>2</sup> → 207

connector X 180 deg  
łącznik X 180 st  
Verbinder X 180 Grad  
connecteur X 180 degrés

**X**<sup>3</sup> → 208

mounting plate X spring  
uchwyt X sprężyna  
Halter X Feder  
fixation X ressort

**B** → 194

diffuser B slide  
klosz B wsuwany  
Abdeckung B einschiebbar  
diffuseur B coulissant

**C** → 195

diffuser C click  
klosz C klik  
Abdeckung C einclipsbar  
diffuseur C clic

**C**<sup>1</sup> → 195

diffuser C click lens gen2  
klosz C klik soczewka gen2  
Abdeckung C einclipsbar Linse gen2  
diffuseur C clic lentille gen 2



white painted  
biały malowany  
weiß lackiert  
peint en blanc



anodized  
anodowany  
eloxiert  
surface anodisée



black anodized  
czarny anodowany  
schwarz eloxiert  
noir anodisé



raw aluminium  
surowe aluminium  
Rohaluminium  
aluminium brut

1000 mm	76200001	76200020	76200021	76200000
2000 mm	76210001	76210020	76210021	76210000
3000 mm	76690001	76690020	76690021	76690000
4050 mm	76700001	76700020	76700021	76700000

end cap GROOVE10 gen2 with hole  
zaślepka GROOVE10 gen2 z otworem  
Endkappe GROOVE10 gen2 mit Öffnung  
embout GROOVE10 gen2 avec un trou



white  
biały  
weiß  
blanc  
76980001

silver  
srebrny  
silbern  
argent  
76980040

black  
czarny  
schwarz  
noir  
76980002

grey  
szary  
grau  
gris  
76980022

end cap GROOVE10 gen2 SQ with hole  
zaślepka GROOVE10 gen2 SQ z otworem  
Endkappe GROOVE10 gen2 SQ mit Öffnung  
embout GROOVE10 gen2 SQ avec un trou



white  
biały  
weiß  
blanc  
76990001

silver  
srebrny  
silbern  
argent  
76990040

black  
czarny  
schwarz  
noir  
76990002

grey  
szary  
grau  
gris  
76990022

connector GROOVE10 90 deg  
łącznik GROOVE10 90 st  
Verbinder GROOVE10 90 Grad  
connecteur GROOVE10 90 degrés

material: aluminium  
materiał: aluminium  
Material: Aluminium  
matériel: aluminium

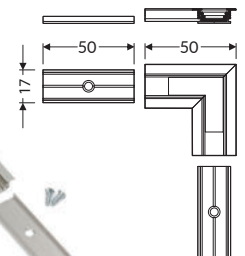

white painted  
biały malowany  
weiß lackiert  
peint en blanc  
76530001

anodized  
anodowany  
eloxiert  
surface anodisée  
76530020

black anodized  
czarny anodowany  
schwarz eloxiert  
noir anodisé  
76530021



# GROOVE10.v2 A1C/U



max 10 mm



recessed  
wpustowy  
Einbauprofile  
encastrés



furniture  
meblowe  
Möbel-  
mobilier

- a new generation of recessed profiles
- basic and aesthetically pleasing furniture profile
- shallow mounting hole depth

- nowa generacja profili wpustowych
- podstawowy i estetyczny profil meblowy
- niewielka głębokość otworu montażowego

- neue Generation der Einbauprofile
- einfaches und ästhetisches Möbelprofil
- geringe Tiefe des Montagelochs

- nouvelle génération de profilés de rainure
- profilé de mobilier basique et esthétique
- faible profondeur du trou de montage



more  
information



więcej  
szczegółów



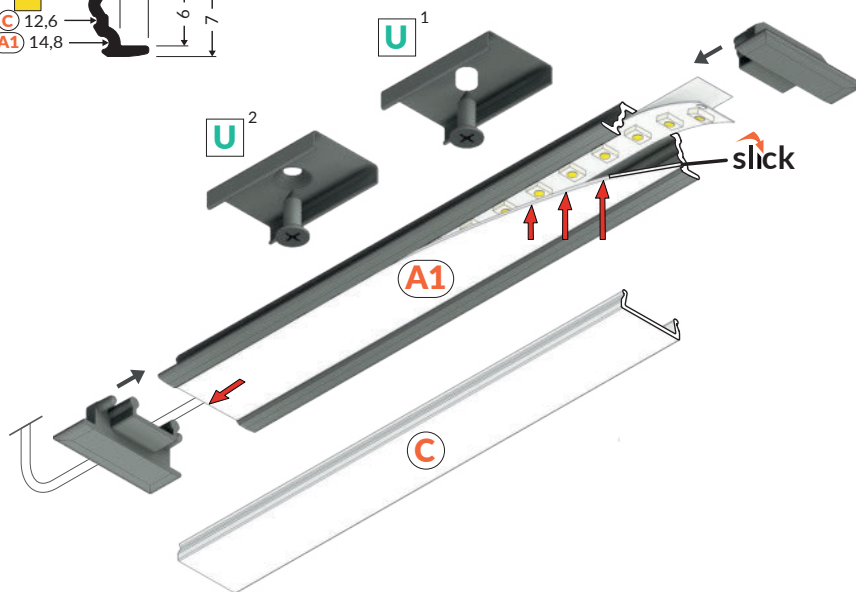
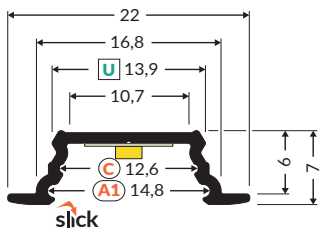

**U<sup>1</sup>** → 204

mounting plate U  
uchwył U  
Halter U  
fixation U

**U<sup>2</sup>** → 204

mounting plate U cone  
uchwył U cone  
Halter U cone  
fixation U cône

**A1** → 194

diffuser A1 slide  
klosz A1 wsuwany  
Abdeckung A1 einschiebbar  
diffuseur A1 coulissant

**C** → 195

diffuser C klik  
klosz C klik  
Abdeckung C einclipsbar  
diffuseur C clic



white painted  
biały malowany  
weiß lackiert  
peint en blanc



anodized  
anodowany  
eloxiert  
surface anodisée



black anodized  
czarny anodowany  
schwarz eloxiert  
noir anodisé



raw aluminium  
surowe aluminium  
Rohaluminium  
aluminium brut

1000 mm	K5000101	K5000120	K5000121	K5000100
2000 mm	K5000201	K5000220	K5000221	K5000200
3000 mm	K5000301	K5000320	K5000321	K5000300
4050 mm	K5000401	K5000420	K5000421	K5000400

end cap GROOVE10.v2 with hole  
zaślepka GROOVE10.v2 z otworem  
Endkappe GROOVE10.v2 mit Öffnung  
embout GROOVE10.v2 avec un trou

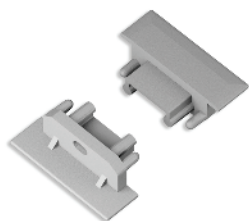

white  
biały  
weiß  
blanc  
K5999901

silver  
srebrny  
silbern  
argent  
K5999940

black  
czarny  
schwarz  
noir  
K5999902

grey  
szary  
grau  
gris  
K5999922





# GROOVE14 EE7F/TY



- used mainly in furniture  
- many accessories available

- głównie do zastosowania  
meblowego  
- wiele akcesoriów do wyboru

- hauptsächlich für  
Möbelanwendung  
- viele Systemzubehörteile  
zur Auswahl

- principalement pour les mobiliers  
- de nombreux accessoires  
au choix



more  
information



więcej  
szczegółów



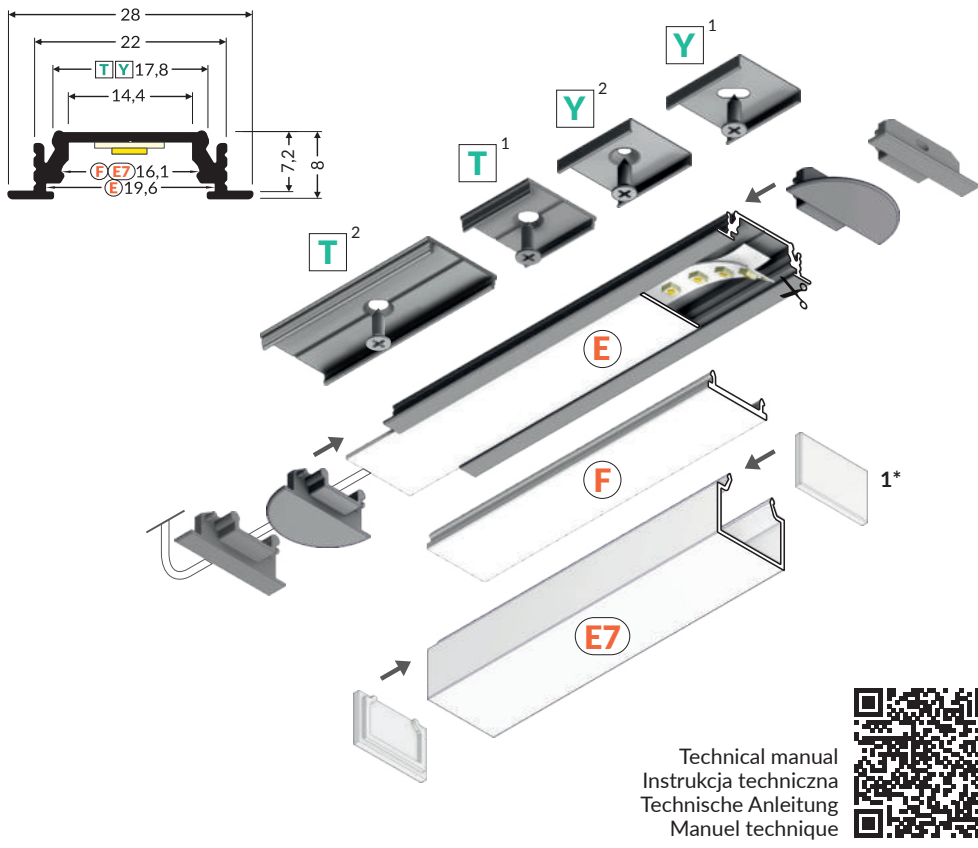

**Y<sup>1</sup>** → 208

mounting plate Y  
uchwyt Y  
Halter Y  
fixation Y

**Y<sup>2</sup>** → 208

mounting plate Y cone  
uchwyt Y cone  
Halter Y cone  
fixation Y cône

**T<sup>1</sup>** → 204

mounting plate T  
uchwyt T  
Halter T  
fixation T

**T<sup>2</sup>** → 204

connector T 180 deg  
łącznik T 180 st  
Verbinder T 180 Grad  
connecteur T 180 degrés

**E** → 198

diffuser E slide  
klosz E wsuwany  
Abdeckung E einschiebbar  
diffuseur E coulissant

**F** → 199

diffuser F click  
klosz F klik  
Abdeckung F einclipsbar  
diffuseur F clic

**E7** → 198

diffuser E7 click  
klosz E7 klik  
Abdeckung E7 einclipsbar  
diffuseur E7 clic

**1\*** → 198

end cap E7  
zaślepka E7  
Endkappe E7  
embout E7

Technical manual  
Instrukcja techniczna  
Technische Anleitung  
Manuel technique



white painted biały malowany weiß lackiert peint en blanc	anodized anodowany eloxiert surface anodisée	black anodized czarny anodowany schwarz eloxiert noir anodisé	raw aluminium surowe aluminium Rohaluminium aluminium brut
1000 mm <b>A3010001</b>	<b>A3010020</b>	<b>A3010021</b>	<b>A3010000</b>
2000 mm <b>A3020001</b>	<b>A3020020</b>	<b>A3020021</b>	<b>A3020000</b>
3000 mm <b>A3090001</b>	<b>A3090020</b>	<b>A3090021</b>	<b>A3090000</b>
4050 mm <b>A3120001</b>	<b>A3120020</b>	<b>A3120021</b>	<b>A3120000</b>

end cap GROOVE14 gen2 with hole  
zaślepka GROOVE14 gen2 z otworem  
Endkappe GROOVE14 gen2 mit Öffnung  
embout GROOVE14 gen2 avec un trou



white biały weiß blanc	silver srebrny silbern argent	<b>A3970001</b>	<b>A3970040</b>
black czarny schwarz noir	grey szary grau gris	<b>A3970002</b>	<b>A3970022</b>

end cap GROOVE14 gen2 SQ with hole  
zaślepka GROOVE14 gen2 SQ z otworem  
Endkappe GROOVE14 gen2 SQ mit Öffnung  
embout GROOVE14 gen2 SQ avec un trou



white biały weiß blanc	silver srebrny silbern argent	<b>A3980001</b>	<b>A3980040</b>
black czarny schwarz noir	grey szary grau gris	<b>A3980002</b>	<b>A3980022</b>

connector GROOVE14 90 deg  
łącznik GROOVE14 90 st  
Verbinder GROOVE14 90 Grad  
connecteur GROOVE14 90 degrés

material: aluminium  
materiał: aluminium  
Material: Aluminium  
matériel: aluminium

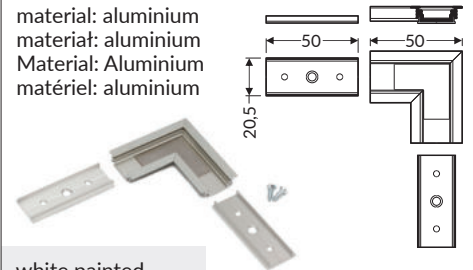

white painted biały malowany weiß lackiert peint en blanc	<b>A3990001</b>
anodized anodowany eloxiert surface anodisée	<b>A3990020</b>

black anodized czarny anodowany schwarz eloxiert noir anodisé	<b>A3990021</b>
--	-----------------



# GROOVE14.v2 BC3/Y



max 14 mm



recessed  
wpustowy  
Einbauprofile  
encastrés



furniture  
meblowe  
Möbel-  
mobilier

- a new generation of recessed profiles
- basic and aesthetically pleasing furniture profile
- shallow mounting hole depth

- nowa generacja profili wpustowych
- podstawowy i estetyczny profil meblowy
- niewielka głębokość otworu montażowego

- neue Generation der Einbauprofile
- einfaches und ästhetisches Möbelprofil
- geringe Tiefe des Montagelochs

- nouvelle génération de profilés à encastrer
- profilé de mobilier basique et esthétique
- faible profondeur du trou de montage



more  
information



więcej  
szczegółów



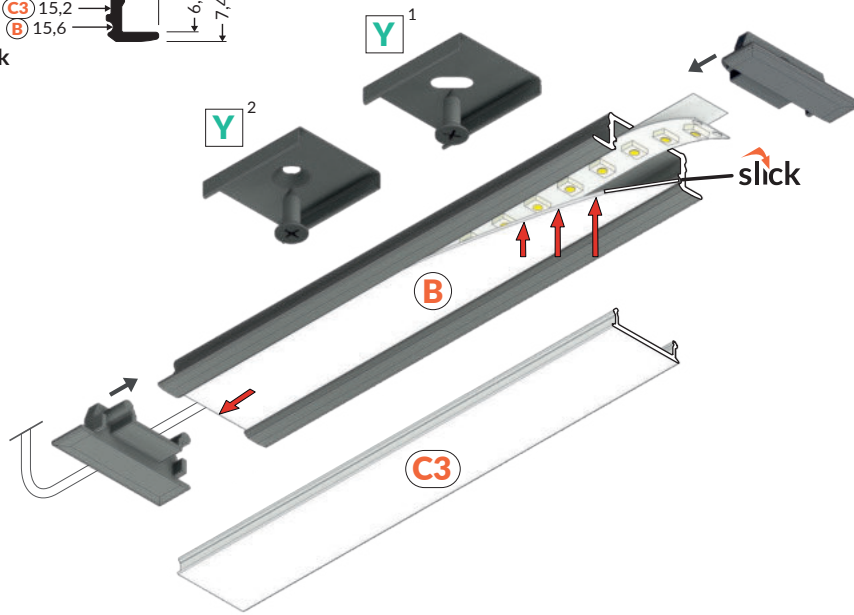
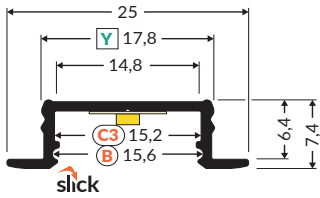

**Y<sup>1</sup>** → 208

mounting plate Y  
uchwyt Y  
Halter Y  
fixation Y

**Y<sup>2</sup>** → 208

mounting plate Y cone  
uchwyt Y cone  
Halter Y cone  
fixation Y cône

**B** → 194

diffuser B slide  
klosz B wsuwany  
Abdeckung B einschiebbar  
diffuseur B coulissant

**C3** → 196

diffuser C3 click  
klosz C3 klik  
Abdeckung C3 einclipsbar  
diffuseur C3 clic



white painted  
biały malowany  
weiß lackiert  
peint en blanc



anodized  
anodowany  
eloxiert  
surface anodisée

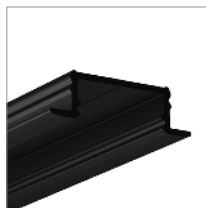

black anodized  
czarny anodowany  
schwarz eloxiert  
noir anodisé



raw aluminium  
surowe aluminium  
Rohaluminium  
aluminium brut

1000 mm	K6000101	K6000120	K6000121	K6000100
2000 mm	K6000201	K6000220	K6000221	K6000200
3000 mm	K6000301	K6000320	K6000321	K6000300
4050 mm	K6000401	K6000420	K6000421	K6000400

end cap GROOVE14.v2 with hole  
zaślepka GROOVE14.v2 z otworem  
Endkappe GROOVE14.v2 mit Öffnung  
embout GROOVE14.v2 avec un trou



white  
biały  
weiß  
blanc  
K6999901

silver  
srebrny  
silbern  
argent  
K6999940

black  
czarny  
schwarz  
noir  
K6999902

grey  
szary  
grau  
gris  
K6999922





# DIAGONAL14 F/TY



max 14 mm



recessed  
wpustowy  
Einbauprofile  
encastrés



furniture  
meblowe  
Möbel-  
mobilier

- reduced glare effect  
- best for furniture applications

- zmniejszony efekt ośnienia  
- głównie do zastosowania  
meblowego

- reduzierter Blendeffekt  
- hauptsächlich  
für Möbelanwendung

- effet d'éblouissement réduit  
- principalement pour le mobilier



more  
information



więcej  
szczegółów



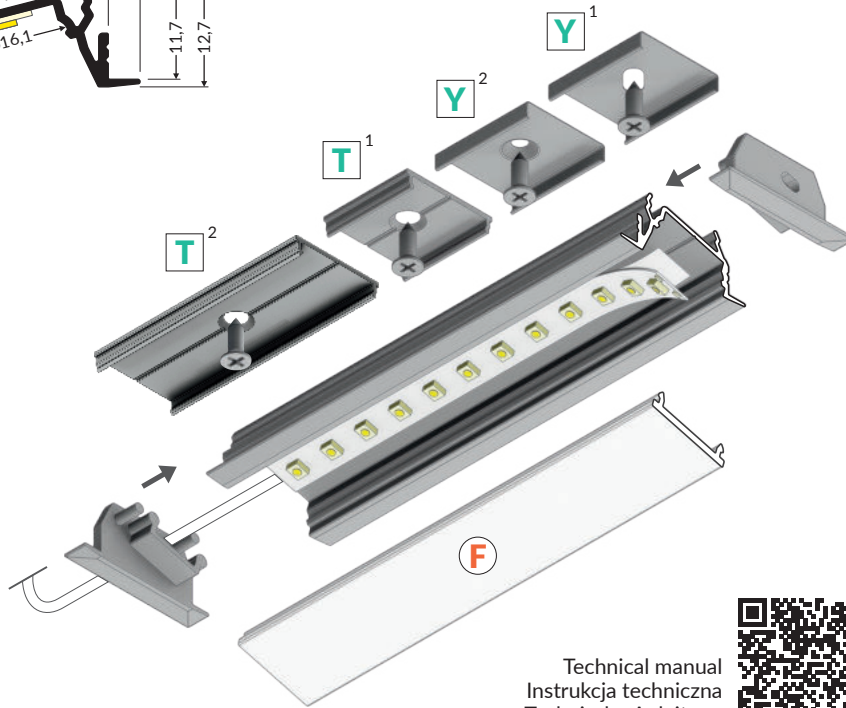
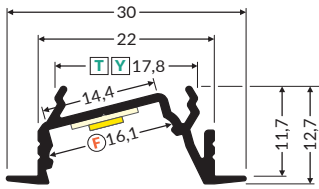

Technical manual  
Instrukcja techniczna  
Technische Anleitung  
Manuel technique



**Y**<sup>1</sup> → 208

mounting plate Y  
uchwyt Y  
Halter Y  
fixation Y

**Y**<sup>2</sup> → 208

mounting plate Y cone  
uchwyt Y cone  
Halter Y cone  
fixation Y cône

**T**<sup>1</sup> → 204

mounting plate T  
uchwyt T  
Halter T  
fixation T

**T**<sup>2</sup> → 204

connector T 180 deg  
łącznik T 180 st  
Verbinder T 180 Grad  
connecteur T 180 degrés

**F** → 199

diffuser F click  
klosz F klik  
Abdeckung F einclipsbar  
diffuseur F clic

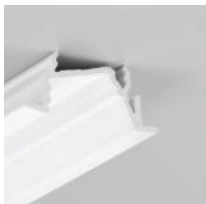

white painted  
biały malowany  
weiß lackiert  
peint en blanc



anodized  
anodowany  
eloxiert  
surface anodisée

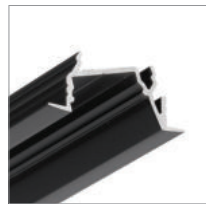

black anodized  
czarny anodowany  
schwarz eloxiert  
noir anodisé



raw aluminium  
surowe aluminium  
Rohaluminium  
aluminium brut

1000 mm	<b>H5010001</b>	<b>H5010020</b>	<b>H5010021</b>	<b>H5010000</b>
2000 mm	<b>H5020001</b>	<b>H5020020</b>	<b>H5020021</b>	<b>H5020000</b>
3000 mm	<b>H5090001</b>	<b>H5090020</b>	<b>H5090021</b>	<b>H5090000</b>
4050 mm	<b>H5120001</b>	<b>H5120020</b>	<b>H5120021</b>	<b>H5120000</b>

end cap DIAGONAL14 with hole  
zaślepka DIAGONAL14 z otworem  
Endkappe DIAGONAL14 mit Öffnung  
embout DIAGONAL14 avec un trou

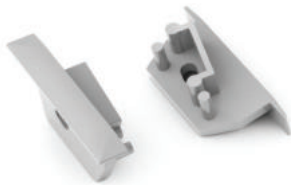

white  
biały  
weiß  
blanc  
**H5999901**

silver  
srebrny  
silbern  
argent  
**H5999940**

black  
czarny  
schwarz  
noir  
**H5999902**

grey  
szary  
grau  
gris  
**H5999922**





# DEEP10 BC/UX



- mainly used in furniture or plasterboard
- continuous line of light (when using LED strip 120 P/m and opal diffuser)
- angled profile sides are designed for better light reflection

- zastosowanie głównie meblowe lub w płycie karton-gips
- ciągła linia światła przy użyciu taśmy 120 P/m i klosza mlecznego
- ścianki profilu ustawione pod kątem działające jak odbłyśnik

- Anwendung hauptsächlich in Möbeln oder in Rigipsplatten
- eine homogene Lichtlinie unter Benutzung des LED Streifens mit 120 leds/m und einer opalen Abdeckung
- die Wänden des LED Profils unter einem Winkel eingestellt, die als Reflektor wirken

- principalement utilisé dans les meubles ou dans les plaques de plâtre
- une ligne de lumière continue à l'aide d'un ruban 120 P/m et d'un diffuseur opaque
- parois des profilés inclinés faisant office de réflecteur



more  
information



więcej  
szczegółów

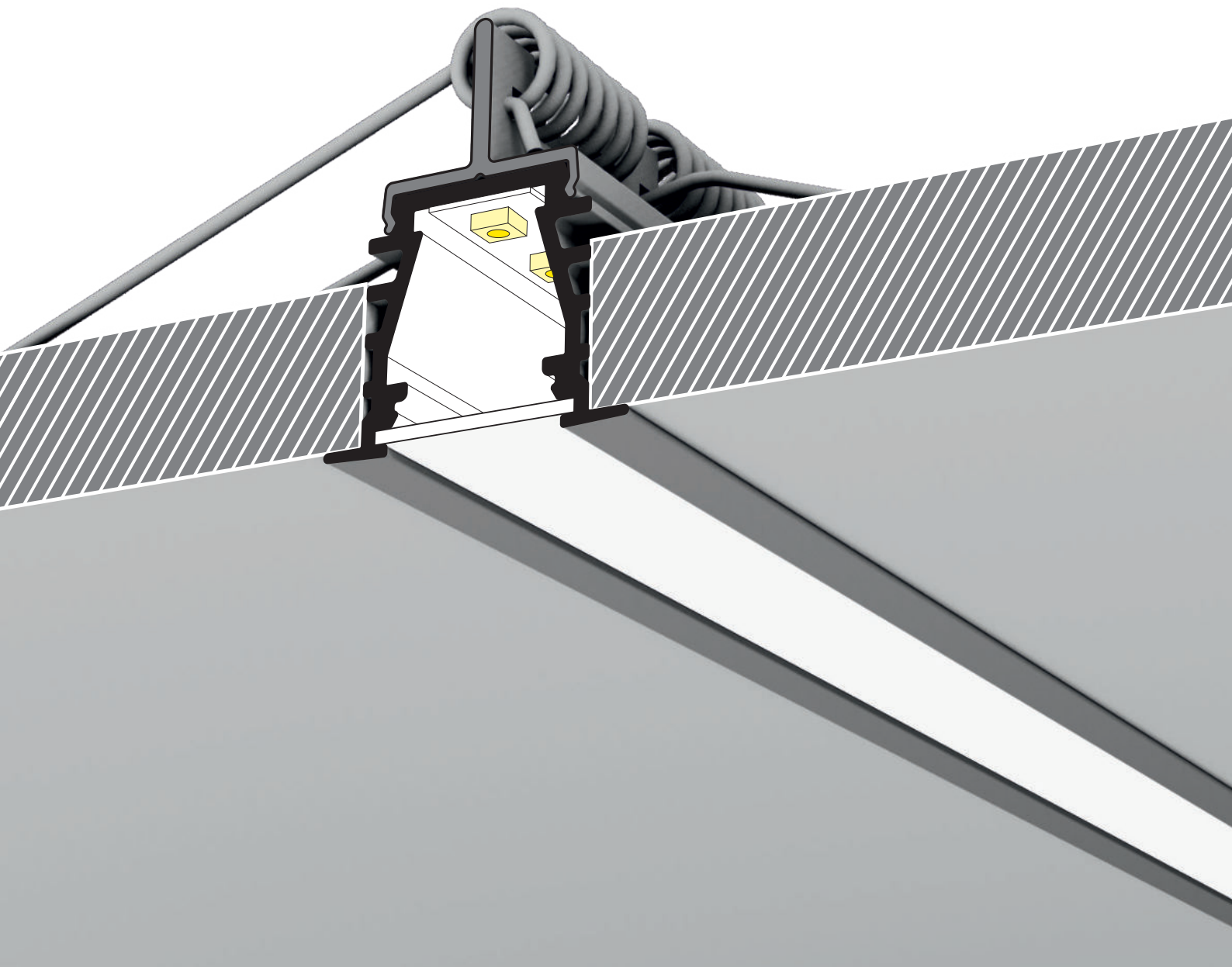

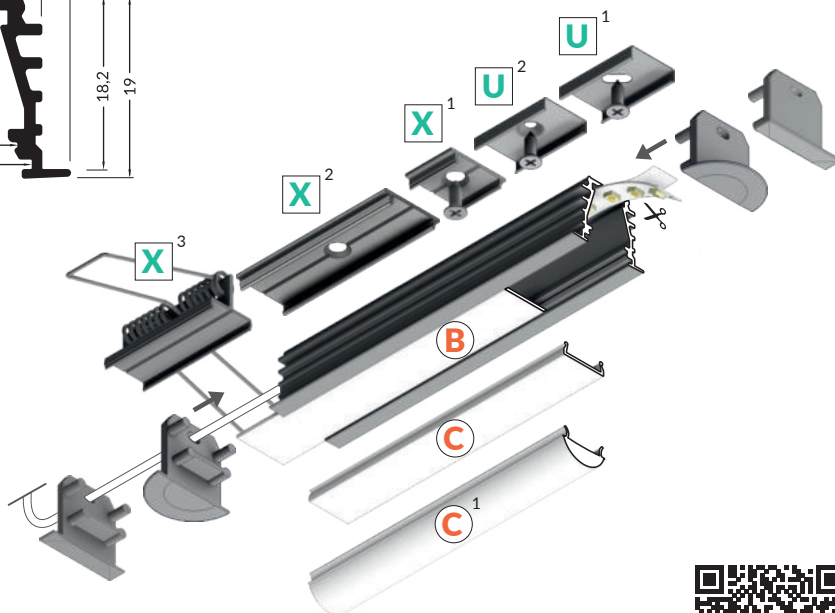
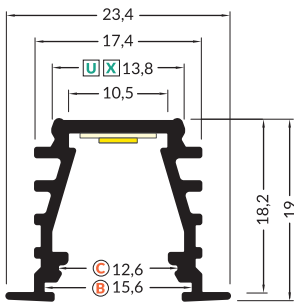

Technical manual  
Instrukcja techniczna  
Technische Anleitung  
Manuel technique



**U**<sup>1</sup> → 204

mounting plate U  
uchwyt U  
Halter U  
fixation U

**U**<sup>2</sup> → 204

mounting plate U cone  
uchwyt U cone  
Halter U cone  
fixation U cône

**X**<sup>1</sup> → 207

mounting plate X  
uchwyt X  
Halter X  
fixation X

**X**<sup>2</sup> → 207

connector X 180 deg  
łącznik X 180 st  
Verbinder X 180 Grad  
connecteur X 180 degrés

**X**<sup>3</sup> → 208

mounting plate X spring  
uchwyt X sprężyna  
Halter X Feder  
fixation X ressort

**B** → 194

diffuser B slide  
klosz B wsuwany  
Abdeckung B einschiebbar  
diffuseur B coulissant

**C** → 195

diffuser C click  
klosz C klik  
Abdeckung C einclipsbar  
diffuseur C clic

**C**<sup>1</sup> → 195

diffuser C click lens gen2  
klosz C klik soczewka gen2  
Abdeckung C einclipsbar Linse gen2  
diffuseur C clic lentille gen 2



white painted  
biały malowany  
weiß lackiert  
peint en blanc



anodized  
anodowany  
eloxiert  
surface anodisée

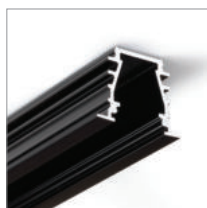

black anodized  
czarny anodowany  
schwarz eloxiert  
noir anodisé



raw aluminium  
surowe aluminium  
Rohaluminium  
aluminium brut

1000 mm	96020001	96020020	96020021	96020000
2000 mm	96030001	96030020	96030021	96030000
3000 mm	96040001	96040020	96040021	96040000
4050 mm	96050001	96050020	96050021	96050000

end cap DEEP10 gen2 with hole  
zaślepka DEEP10 gen2 z otworem  
Endkappe DEEP10 gen2 mit Öffnung  
embout DEEP10 gen2 avec un trou



white biały weiß blanc	silver srebrny silbern argent
96980001	96980040

black czarny schwarz noir	grey szary grau gris
96980002	96980022

end cap DEEP10 gen2 SQ with hole  
zaślepka DEEP10 gen2 SQ z otworem  
Endkappe DEEP10 gen2 SQ mit Öffnung  
embout DEEP10 gen2 SQ avec un trou



white biały weiß blanc	silver srebrny silbern argent
96990001	96990040

black czarny schwarz noir	grey szary grau gris
96990002	96990022



# SMART-IN16 BC3/U4



max 16 mm



recessed  
wpustowy  
Einbauprofile  
encastrés



furniture  
mebłowe  
Möbel-  
mobilier

- used mainly in furniture
- ceiling installation possible
- 6 types of diffusers

- głównie do zastosowania meblowego
- możliwe zastosowanie sufitowe
- 6 rodzajów kloszy

- auch für die Möbelanwendung
- Deckenmontage möglich
- 6 Abdeckungen zur Wahl

- principalement pour l'ameublement
- application au plafond possible
- 6 types de diffuseurs



more  
information



więcej  
szczegółów





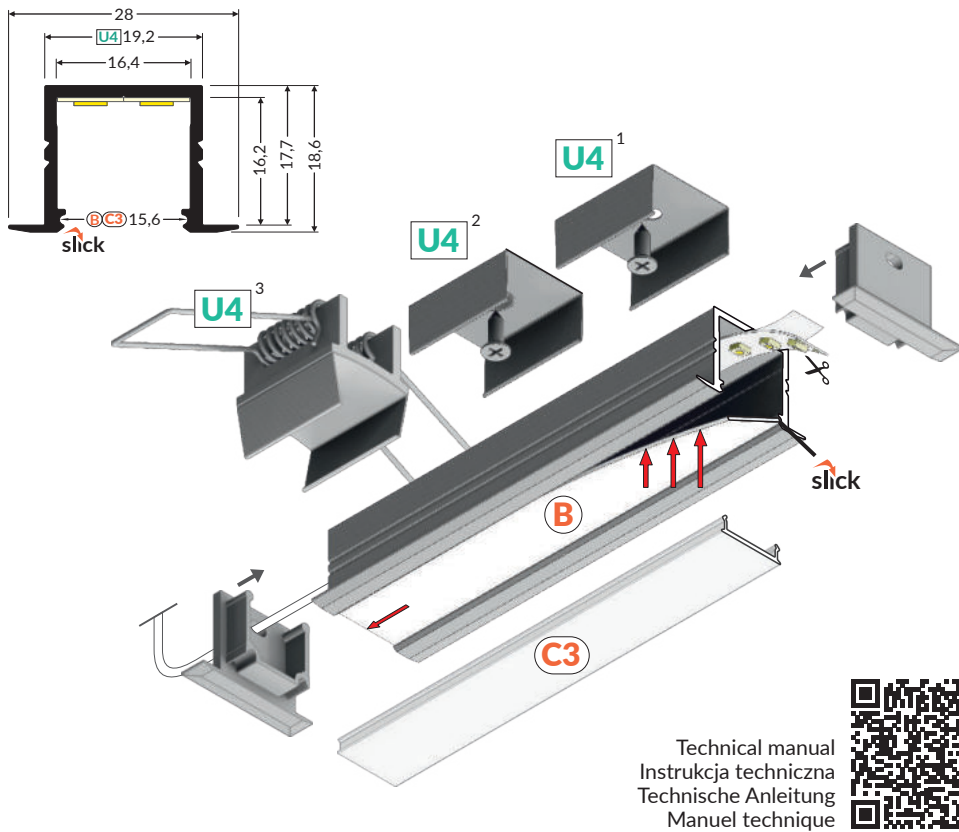

**U4**<sup>1</sup> → 205

mounting plate U4  
uchwyt U4  
Halter U4  
fixation U4

**U4**<sup>2</sup> → 205

mounting plate U4 cone  
uchwyt U4 cone  
Halter U4 cone  
fixation U4 cône

**U4**<sup>3</sup> → 205

mounting plate U4 spring  
uchwyt U4 sprężyna  
Halter U4 Feder  
fixation U4 ressort

**B** → 194

diffuser B slide  
klosz B wsuwany  
Abdeckung B einschiebbar  
diffuseur B coulissant

**C3** → 196

diffuser C3 click  
klosz C3 klik  
Abdeckung C3 einclipsbar  
diffuseur C3 clic

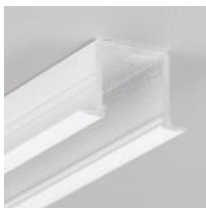

white painted  
biały malowany  
weiß lackiert  
peint en blanc

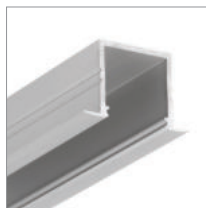

anodized  
anodowany  
eloxiert  
surface anodisée



raw aluminium  
surowe aluminium  
Rohaluminium  
aluminium brut

1000 mm	<b>F6000101</b>	<b>F6000120</b>	<b>F6000100</b>
2000 mm	<b>F6000201</b>	<b>F6000220</b>	<b>F6000200</b>
3000 mm	<b>F6000301</b>	<b>F6000320</b>	<b>F6000300</b>
4050 mm	<b>F6000401</b>	<b>F6000420</b>	<b>F6000400</b>

end cap SMART-IN16-BC3 with hole  
zaślepka SMART-IN16-BC3 z otworem  
Endkappe SMART-IN16-BC3 mit Öffnung  
embout SMART-IN16-BC3 avec un trou



white  
biały  
weiß  
blanc  
**F6999901**

silver  
srebrny  
silbern  
argent  
**F6999940**

grey  
szary  
grau  
gris  
**F6999922**



# LINEA-IN20 EE7F/U7



max 20 mm



recessed  
wpustowy  
Einbauprofile  
encastrés



architectural  
architektoniczne  
architektonisch  
architecture



lighting  
oświetleniowe  
Beleuchtungs-  
éclairage d'ambiance

- continuous line of light (when using LED strip 120 P/m and opal diffuser)
- angled connections illuminated
- over 20 accessories available

- ciągła linia światła (przy użyciu taśm 120 P/m oraz klosza mlecznego)
- świecące połączenia kątowe
- ponad 20 akcesoriów

- eine homogene Lichtlinie unter Anwendung des LED Streifens mit 120 leds/m und einer opalen Abdeckung
- leuchtende Eckverbindungen
- mehr als 20 Zubehörteile

- ligne continue de lumière (en utilisant le ruban 120 P/M. et un diffuseur)
- connecteurs d'angles éclairés
- plus de 20 accessoires



more  
information



więcej  
szczegółów



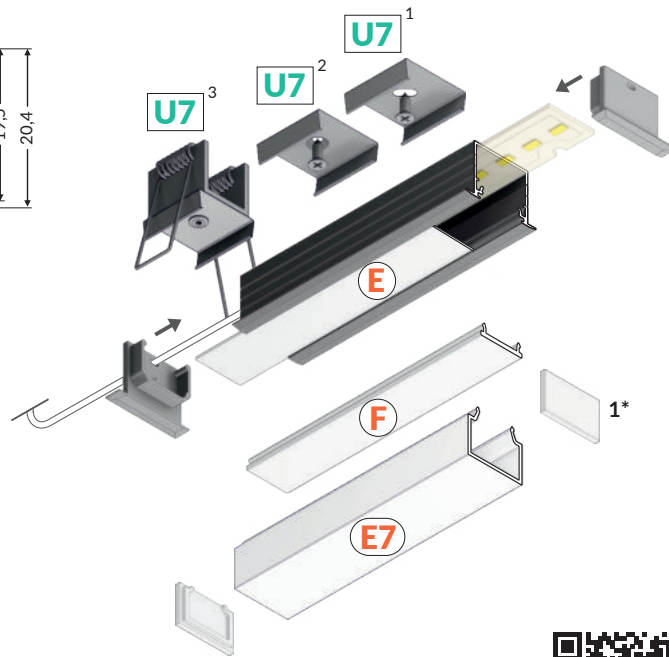
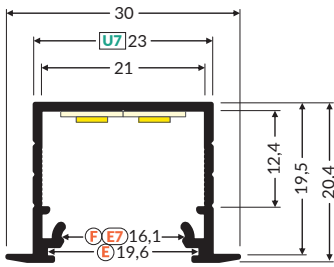

Technical manual  
Instrukcja techniczna  
Technische Anleitung  
Manuel technique



**U7**<sup>1</sup> → 206

mounting plate U7  
uchwyt U7  
Halter U7  
fixation U7

**U7**<sup>2</sup> → 206

mounting plate U7 cone  
uchwyt U7 cone  
Halter U7 cone  
fixation U7 cône

**U7**<sup>3</sup> → 206

mounting plate U7 spring  
uchwyt U7 sprężyna  
Halter U7 Feder  
fixation U7 ressort

**E** → 198

diffuser E slide  
klosz E wsuwany  
Abdeckung E einschiebbar  
diffuseur E coulissant

**F** → 199

diffuser F click  
klosz F klik  
Abdeckung F einclipsbar  
diffuseur F clic

**E7** → 198

diffuser E7 click  
klosz E7 klik  
Abdeckung E7 einclipsbar  
diffuseur E7 clic

**1\*** → 198

end cap E7  
zaślepka E7  
Endkappe E7  
embout E7



white painted  
biały malowany  
weiß lackiert  
peint en blanc

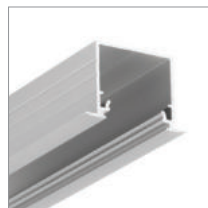

anodized  
anodowany  
eloxiert  
surface anodisée



black anodized  
czarny anodowany  
schwarz eloxiert  
noir anodisé



raw aluminium  
surowe aluminium  
Rohaluminium  
aluminium brut

1000 mm	<b>E4010001</b>	<b>E4010020</b>	<b>E4010021</b>	<b>E4010000</b>
2000 mm	<b>E4020001</b>	<b>E4020020</b>	<b>E4020021</b>	<b>E4020000</b>
3000 mm	<b>E4030001</b>	<b>E4030020</b>	<b>E4030021</b>	<b>E4030000</b>
4050 mm	<b>E4040001</b>	<b>E4040020</b>	<b>E4040021</b>	<b>E4040000</b>

end cap LINEA-IN20 with hole  
zaślepka LINEA-IN20 z otworem  
Endkappe LINEA-IN20 mit Öffnung  
embout LINEA-IN20 avec un trou



white biały weiß blanc	silver srebrny silbern argent
<b>E4990001</b>	<b>E4990040</b>

black czarny schwarz noir	grey szary grau gris
<b>E4990002</b>	<b>E4990022</b>

end cap LINEA-IN20-E7 with hole  
zaślepka LINEA-IN20-E7 z otworem  
Endkappe LINEA-IN20-E7 mit Öffnung  
embout LINEA-IN20-E7 avec un trou



white biały weiß blanc	silver srebrny silbern argent
<b>E4999901</b>	<b>E4999940</b>

black czarny schwarz noir	grey szary grau gris
<b>E4999902</b>	<b>E4999922</b>



# CONNECTION POSSIBILITY MOŻLIWOŚCI ŁĄCZENIA VERBINDUNGSMÖGLICHKEITEN COMBINAISON POSSIBLE

## ANGULAR CONNECTORS

Thanks to five different angle connectors (60° / 90° / 120° / 135° / 180°) it is possible to create many various lighting systems – with no need to cut the profile at an angle. Bent connectors allows to connect profiles in two planes, at two angles: 90° on the inside and 270° on the outside.

## ŁĄCZNIKI KĄTOWE

Dzięki łącznikom o pięciu różnych kątach (60° / 90° / 120° / 135° / 180°) możliwe jest tworzenie wielu różnych układów oświetlenia bez konieczności cięcia profilu pod skosem. Łączniki gięte umożliwiają łączenie profili w dwóch płaszczyznach, pod dwoma kątami: wewnętrznym 90° i zewnętrznym 270°.

## ECKVERBINDER

Dank den Eckverbindern mit fünf unterschiedlichen Winkeln (60° / 90° / 120° / 135° / 180°) ist es möglich die Bildung von vielen unterschiedlichen Lichtvarianten, ohne das Profil auf Gehrung zuschneiden müssen. Gebogene Verbindungsstücke ermöglichen das Verbinden von zwei Profilen in zwei Ebenen, unter zwei Winkeln; dem inneren Winkel von 90° und dem äußeren Winkel von 270°.

## CONNECTEURS D'ANGLES

Grâce à des connecteurs avec cinq angles différents (60° / 90° / 120° / 135° / 180°), il est possible de créer de nombreux systèmes d'éclairage différents sans qu'il soit nécessaire de couper le profilé en angle. Les connecteurs pliables vous permettent de connecter des profilés dans deux plans, à deux angles: 90° interne et 270° externe.

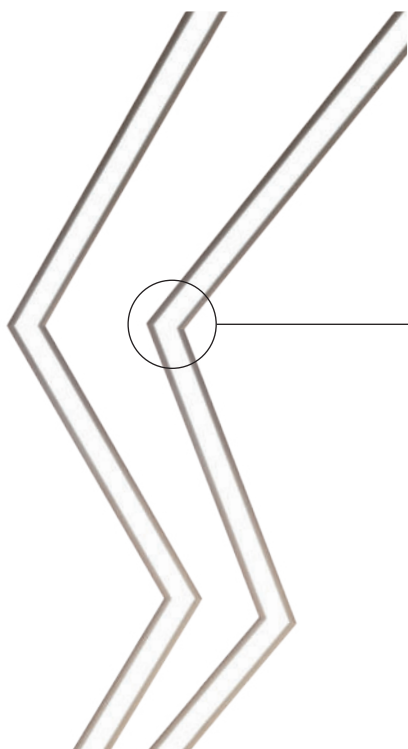
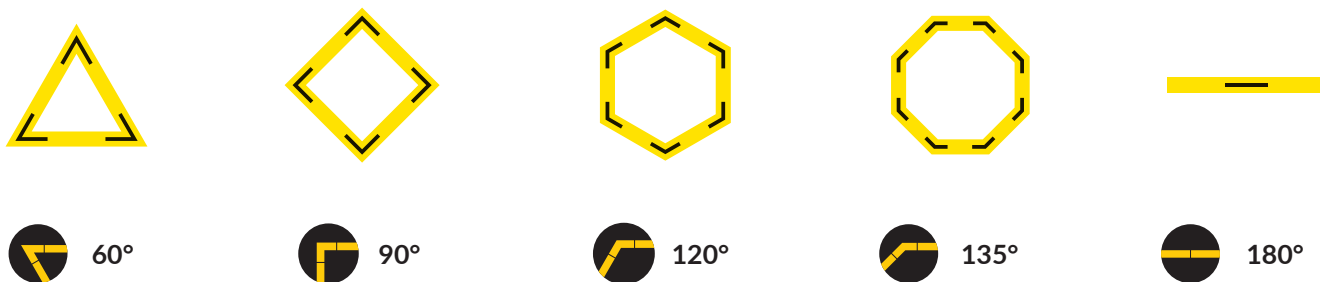

The component made of clear fabric provides secure connection, letting light through at the same time. Thanks to that, the luminaire can illuminate on the entire surface of the diffuser – even in the corners.

Element z przezroczystego tworzywa zapewnia stabilizację łączenia, jednocześnie przepuszczając światło. Dzięki temu oprawa może świecić na całej powierzchni klosza - również w rogach.

Ein Element aus durchsichtigem Kunststoff sichert die Stabilisierung der Verbindung und gleichzeitig lässt das Licht durch. Dadurch kann die Leuchte auf der ganzen Abdeckungsfläche leuchten - auch in den Ecken.

Un élément en matériau transparent assure la stabilisation de la connexion, tout en laissant passer la lumière. Grâce à cela, le luminaire peut briller sur toute la surface du diffuseur – également dans les angles.

# CONNECTORS ŁĄCZNIKI VERBINDER CONNECTEURS

material: aluminium, polycarbonate  
 materiał: aluminium, poliwęglan  
 Material: Aluminium, Polycarbonat  
 matériel: aluminium, polycarbonate

connector LINEA-IN20 60 deg  
 łącznik LINEA-IN20 60 st  
 Verbinder LINEA-IN20 60 Grad  
 connecteur LINEA-IN20 degrés

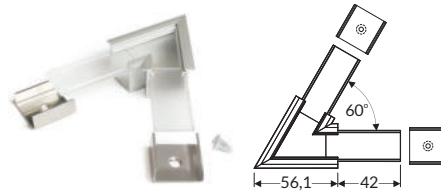

white painted  
 biały malowany  
 weiß lackiert  
 peint en blanc  
**E4890001S**

anodized  
 anodowany  
 eloxiert  
 surface anodisée  
**E4890020S**

black anodized  
 czarny anodowany  
 schwarz eloxiert  
 noir anodisé  
**E4890021S**

connector LINEA-IN20 90 deg  
 łącznik LINEA-IN20 90 st  
 Verbinder LINEA-IN20 90 Grad  
 connecteur LINEA-IN20 degrés



white painted  
 biały malowany  
 weiß lackiert  
 peint en blanc  
**E4900001S**

anodized  
 anodowany  
 eloxiert  
 surface anodisée  
**E4900020S**

black anodized  
 czarny anodowany  
 schwarz eloxiert  
 noir anodisé  
**E4900021S**

connector LINEA-IN20 90 deg bent  
 łącznik LINEA-IN20 90 st gięty  
 Verbinder LINEA-IN20 90 Grad gebogen  
 connecteur LINEA-IN20 90 degrés plié

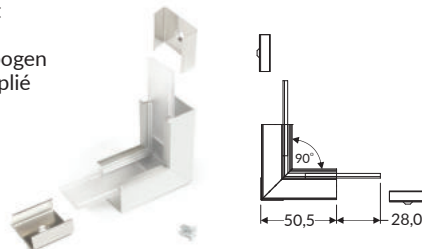

white painted  
 biały malowany  
 weiß lackiert  
 peint en blanc  
**E4910001S**

anodized  
 anodowany  
 eloxiert  
 surface anodisée  
**E4910020S**

black anodized  
 czarny anodowany  
 schwarz eloxiert  
 noir anodisé  
**E4910021S**

connector LINEA-IN20 120 deg  
 łącznik LINEA-IN20 120 st  
 Verbinder LINEA-IN20 120 Grad  
 connecteur LINEA-IN20 120 degrés

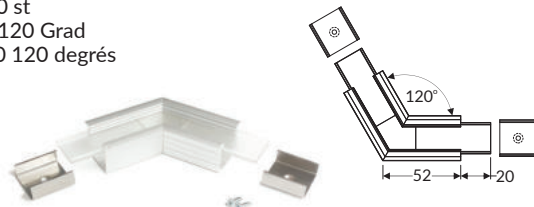

white painted  
 biały malowany  
 weiß lackiert  
 peint en blanc  
**E4930001S**

anodized  
 anodowany  
 eloxiert  
 surface anodisée  
**E4920020S**

black anodized  
 czarny anodowany  
 schwarz eloxiert  
 noir anodisé  
**E4920021S**

connector LINEA-IN20 135 deg  
 łącznik LINEA-IN20 135 st  
 Verbinder LINEA-IN20 135 Grad  
 connecteur LINEA-IN20 135 degrés

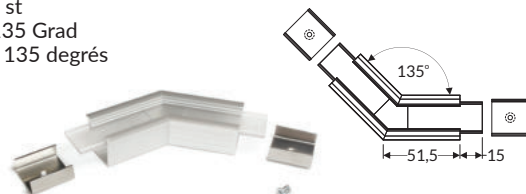

white painted  
 biały malowany  
 weiß lackiert  
 peint en blanc  
**E4920021S**

anodized  
 anodowany  
 eloxiert  
 surface anodisée  
**E4930020S**

black anodized  
 czarny anodowany  
 schwarz eloxiert  
 noir anodisé  
**E4930021S**

connector LINEA-IN20 180 deg  
 łącznik LINEA-IN20 180 st  
 Verbinder LINEA-IN20 180 Grad  
 connecteur LINEA-IN20 180 degrés



**E4940000S**

connector LINEA-IN20 270 deg bent  
 łącznik LINEA-IN20 270 st gięty  
 Verbinder 270 LINEA-IN20 Grad gebogen  
 connecteur LINEA-IN20 270 degrés plié

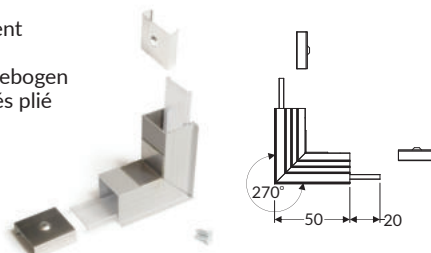

white painted  
 biały malowany  
 weiß lackiert  
 peint en blanc  
**E4950001S**

anodized  
 anodowany  
 eloxiert  
 surface anodisée  
**E4950020S**

black anodized  
 czarny anodowany  
 schwarz eloxiert  
 noir anodisé  
**E4950021S**

# VARIO30-06, 07



max 30 mm



recessed  
wpustowy  
Einbauprofile  
encastrés



architectural  
architektoniczne  
Architectur  
architecture

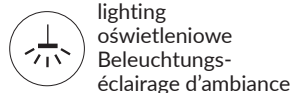

lighting  
oświetleniowe  
Beleuchtungs-  
éclairage d'ambiance

- part of a larger system for luminaire construction
- multiple installation methods
- continuous line of light in angled connections
- unlimited possibilities for light creation

- część większego systemu do budowy opraw oświetleniowych
- wiele sposobów montażu
- ciągła linia światła w połączeniach kątowych
- nieograniczone możliwości kreowania światła

- Teil eines größeren Systems für den Leuchtenbau
- mehrere Montagemethoden
- homogene Lichtlinie in Winkelverbindungen
- unbegrenzte Möglichkeiten der Lichtgestaltung

- un élément d'un très vaste système pour la création de luminaires
- des plusieurs options de montage
- une ligne lumineuse permanente dans les connecteurs angulaires
- des possibilités illimitées concernant la création de lumière

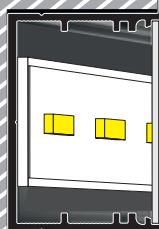
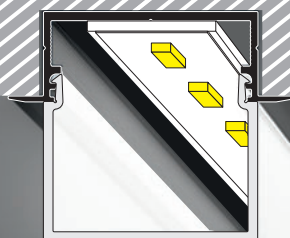



**VARIO30-06**  
**ACDE-9/U9**

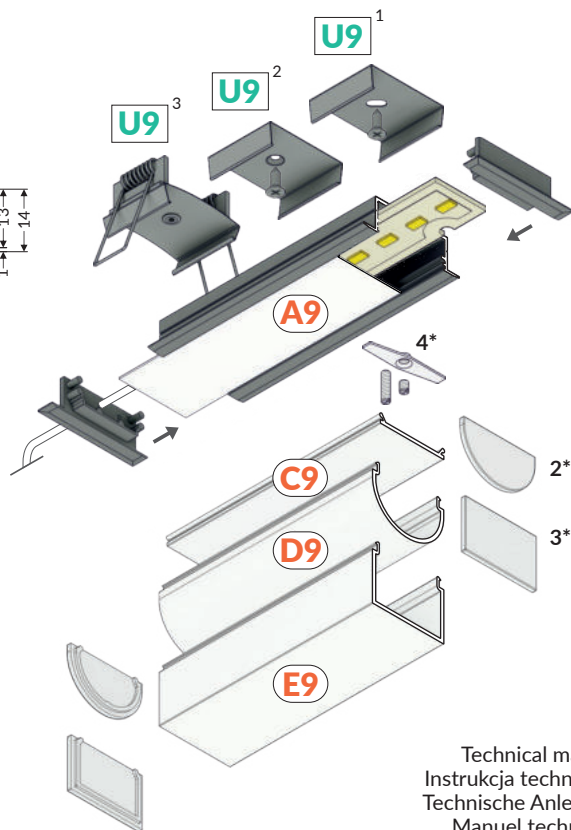
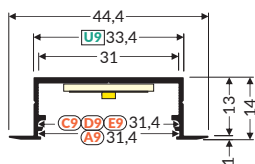

Technical manual  
Instrukcja techniczna  
Technische Anleitung  
Manuel technique



more  
information



więcej  
szczegółów



**U9**<sup>1</sup> → 207

mounting plate U9  
uchwyt U9  
Halter U9  
fixation U9

**U9**<sup>2</sup> → 207

mounting plate U9 cone  
uchwyt U9 cone  
Halter U9 cone  
fixation U9 cône

**U9**<sup>3</sup> → 207

mounting plate U9 spring  
uchwyt U9 sprężyna  
Halter U9 Feder  
fixation U9 ressort

**A9** → 194

diffuser A9 slide  
klosz A9 wsuwany  
Abdeckung A9 einschiebbar  
diffuseur A9 coulissant

**C9** → 197

diffuser C9 click  
klosz C9 klik  
Abdeckung C9 einclipsbar  
diffuseur C9 clic

**D9** → 198

diffuser D9 click  
klosz D9 klik  
Abdeckung D9 einclipsbar  
diffuseur D9

**E9** → 199

diffuser E9 click  
klosz E9 klik  
Abdeckung E9 einclipsbar  
diffuseur E9 clic

**2\*** → 198

end cap D9  
zaślepka D9  
Endkappe D9  
embout D9

**3\*** → 199

end cap E9  
zaślepka E9  
Endkappe E9  
embout E9

**4\*** → 210

LED clamp VARIO30  
docisk LED VARIO30  
LED Klemme VARIO30  
clip de fixation LED VARIO30

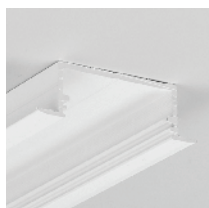

white painted  
biały malowany  
weiß lackiert  
peint en blanc



anodized  
anodowany  
eloxiert  
surface anodisée

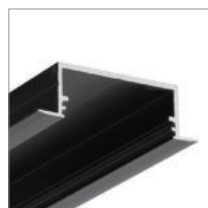

black anodized  
czarny anodowany  
schwarz eloxiert  
noir anodisé

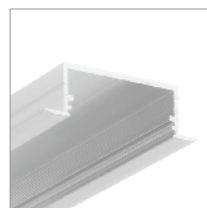

raw aluminium  
surowe aluminium  
Rohaluminium  
aluminium brut

1000 mm	V3210001	V3210020	V3210021	V3210000
2000 mm	V3220001	V3220020	V3220021	V3220000
3000 mm	V3230001	V3230020	V3230021	V3230000
4050 mm	V3240001	V3240020	V3240021	V3240000

end cap VARIO30-06  
zaślepka VARIO30-06  
Endkappe VARIO30-06  
embout VARIO30-06



white            silver  
biały            srebrny  
weiß            silbern  
blanc            argent  
V4920001    V4920040

black            grey  
czarny            szary  
schwarz            grau  
noir            gris  
V4920002    V4920022

**VARIO30-07**  
**ACDE-9/U9**

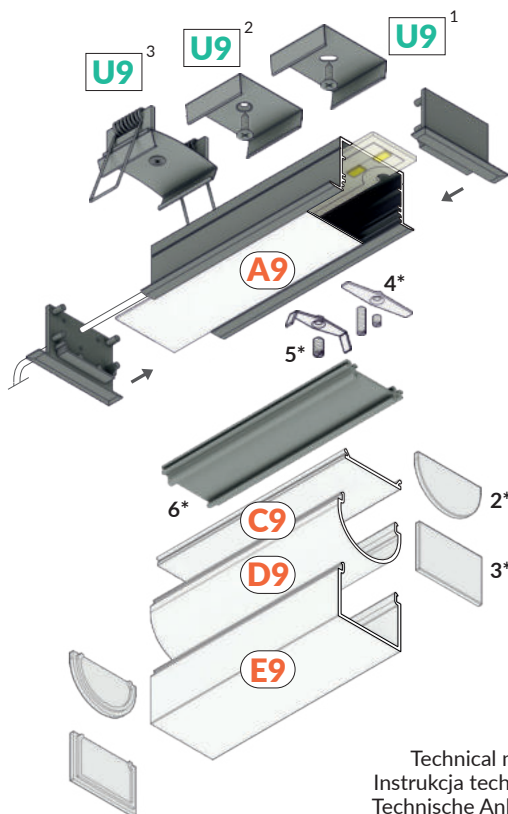
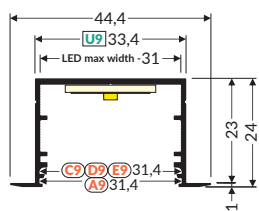

Technical manual  
Instrukcja techniczna  
Technische Anleitung  
Manuel technique



more  
information



więcej  
szczegółów



**U9**<sup>1</sup> → 207

mounting plate U9  
uchwyt U9  
Halter U9  
fixation U9

**U9**<sup>2</sup> → 207

mounting plate U9 cone  
uchwyt U9 cone  
Halter U9 cone  
fixation U9 cône

**U9**<sup>3</sup> → 207

mounting plate U9 spring  
uchwyt U9 sprężyna  
Halter U9 Feder  
fixation U9 ressort

**A9** → 194

diffuser A9 slide  
klosz A9 wsuwany  
Abdeckung A9 einschiebbar  
diffuseur A9 coulissant

**C9** → 197

diffuser C9 click  
klosz C9 klik  
Abdeckung C9 einclipsbar  
diffuseur C9 clic

**D9** → 198

diffuser D9 click  
klosz D9 klik  
Abdeckung D9 einclipsbar  
diffuseur D9 clic

**E9** → 199

diffuser E9 click  
klosz E9 klik  
Abdeckung E9 einclipsbar  
diffuseur E9 clic

**2\*** → 198

end cap D9  
zaślepka D9  
Endkappe D9  
embout D9

**3\*** → 199

end cap E9  
zaślepka E9  
Endkappe E9  
embout E9

**4\*** → 210

LED clamp VARIO30  
docisk LED VARIO30  
LED Klemme VARIO30  
clip de fixation LED VARIO30

**5\*** → 210

LED clamp VARIO30-1  
docisk LED VARIO30-1  
LED Klemme VARIO30-1  
clip de fixation LED VARIO30 1

**6\*** → 210

LED mounting VARIO30  
mocowanie LED VARIO30  
LED Montagetil VARIO30  
fixation LED VARIO30

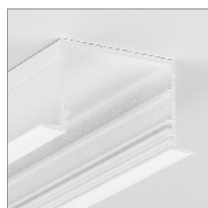

white painted  
biały malowany  
weiß lackiert  
peint en blanc

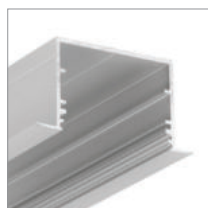

anodized  
anodowany  
eloxiert  
surface anodisée

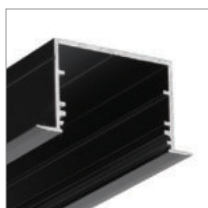

black anodized  
czarny anodowany  
schwarz eloxiert  
noir anodisé

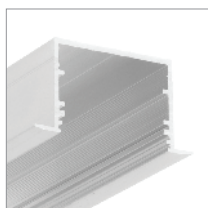

raw aluminium  
surowe aluminium  
Rohaluminium  
aluminium brut

1000 mm  
2000 mm  
3000 mm  
4050 mm

V3250001  
V3260001  
V3270001  
V3280001

V3250020  
V3260020  
V3270020  
V3280020

V3250021  
V3260021  
V3270021  
V3280021

V3250000  
V3260000  
V3270000  
V3280000

end cap VARIO30-07  
zaślepka VARIO30-07  
Endkappe VARIO30-07  
embout VARIO30-07

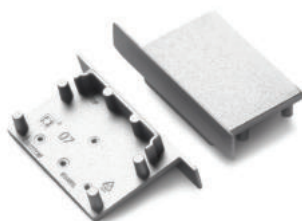

white  
biały  
weiß  
blanc  
V4930001

silver  
srebrny  
silbern  
argent  
V4930040

black  
czarny  
schwarz  
noir  
V4930002

grey  
szary  
grau  
gris  
V4930022

# CONNECTORS ŁĄCZNIKI VERBINDER CONNECTEURS

material: aluminium, polycarbonate  
materiał: aluminium, poliwęglan  
Material: Aluminium, Polycarbonat  
matériel: aluminium, polycarbonate

connector VARIO30-07 60 deg  
łącznik VARIO30-07 60 st  
Verbinder VARIO30-07 60 Grad  
connecteur VARIO30-07 60 degrés

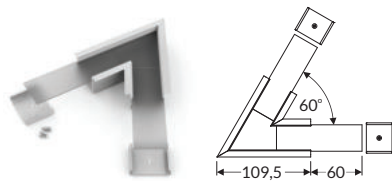

white painted  
biały malowany  
weiß lackiert  
peint en blanc  
**V4780001S**

anodized  
anodowany  
eloxiert  
surface anodisée  
**V4780020S**

black anodized  
czarny anodowany  
schwarz eloxiert  
noir anodisé  
**V4780021S**

connector VARIO30-07 90 deg  
łącznik VARIO30-07 90 st  
Verbinder VARIO30-07 90 Grad  
connecteur VARIO30-07 90 degrés

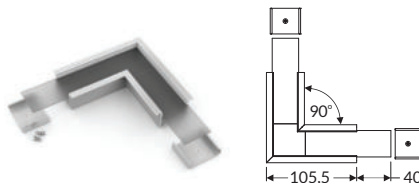

white painted  
biały malowany  
weiß lackiert  
peint en blanc  
**V4790001S**

anodized  
anodowany  
eloxiert  
surface anodisée  
**V4790020S**

black anodized  
czarny anodowany  
schwarz eloxiert  
noir anodisé  
**V4790021S**

connector VARIO30-07 90 deg bent  
łącznik VARIO30-07 90 st gięty  
Verbinder VARIO30-07 90 Grad gebogen  
connecteur VARIO30-07 90 degrés plié

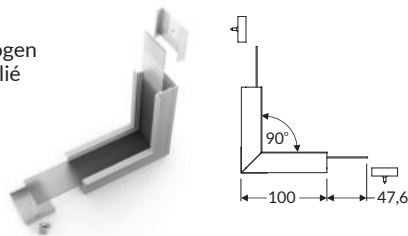

white painted  
biały malowany  
weiß lackiert  
peint en blanc  
**V4800001S**

anodized  
anodowany  
eloxiert  
surface anodisée  
**V4800020S**

black anodized  
czarny anodowany  
schwarz eloxiert  
noir anodisé  
**V4800021S**

connector VARIO30-07 120 deg  
łącznik VARIO30-07 120 st  
Verbinder VARIO30-07 120 Grad  
connecteur VARIO30-07 120 degrés

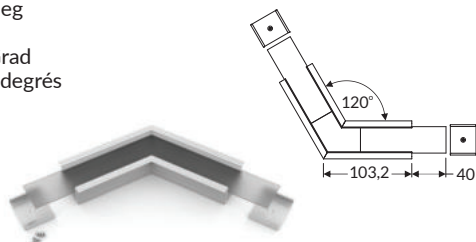

white painted  
biały malowany  
weiß lackiert  
peint en blanc  
**V4810001S**

anodized  
anodowany  
eloxiert  
surface anodisée  
**V4810020S**

black anodized  
czarny anodowany  
schwarz eloxiert  
noir anodisé  
**V4810021S**

connector VARIO30-07 135 deg  
łącznik VARIO30-07 135 st  
Verbinder VARIO30-07 135 Grad  
connecteur VARIO30-07 135 degrés

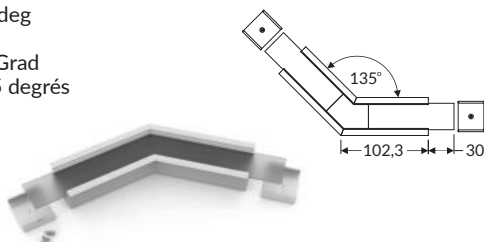

white painted  
biały malowany  
weiß lackiert  
peint en blanc  
**V4820001S**

anodized  
anodowany  
eloxiert  
surface anodisée  
**V4820020S**

black anodized  
czarny anodowany  
schwarz eloxiert  
noir anodisé  
**V4820021S**

connector VARIO30-07 180 deg  
łącznik VARIO30-07 180 st  
Verbinder VARIO30-07 180 Grad  
connecteur VARIO30-07 180 degrés



**V4610000S**

connector VARIO30-07 270 deg bent  
łącznik VARIO30-07 270 st gięty  
Verbinder VARIO30-07 270 Grad gebogen  
connecteur VARIO30-07 270 degrés plié

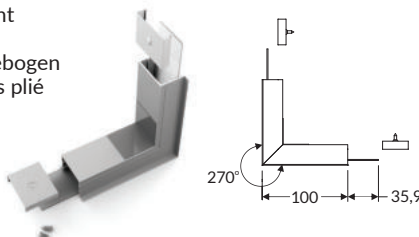

white painted  
biały malowany  
weiß lackiert  
peint en blanc  
**V4830001S**

anodized  
anodowany  
eloxiert  
surface anodisée  
**V4830020S**

black anodized  
czarny anodowany  
schwarz eloxiert  
noir anodisé  
**V4830021S**



# FLAT8 H/UX



max 8 mm



recessed  
wpustowy  
Einbauprofile  
encastrés



architectural  
architektoniczne  
architektonisch  
architecture

- flat recessed profile emitting diffused light glow
- decorative illumination
- a parabolic, reflecting element - even, smooth, diffused light
- a flat profile, designed to fit into plasterboards - installation without interference in the frame construction
- mounted to furniture, walls, pedestals with holders (click-in) or directly (with screws, adhesive tape or glue)

- płaski, wpustowy profil emitujący rozproszoną łunę światła
- oświetlenie dekoracyjne
- paraboliczny odbłyśnik
- równomierne, gładkie, rozproszone światło
- płaski profil mieszczący się w grubości płyty karton-gips, montaż bez ingerencji w stelaż zabudowy
- montaż do mebli, ścian, cokołów za pomocą uchwytów (wklikując) lub bezpośrednio (przykręcając lub wklejając)

- flaches Einbauprofil, das den zerstreuten Lichtschein emittiert
- dekorative Beleuchtung
- ein parabelförmiger Reflektor - gleichmäßiges, glattes und zerstreutes Licht
- ein flaches Profil, dass in die Dicke der Rigipsplatte passt, die Montage gelingt ohne in den Bebauungsständer einzugreifen
- die Montage an den Möbeln, Wänden, an den Sockeln mit Hilfe von Haltern (durch Einclippen) oder direkt (durch das Zuschrauben oder Einkleben)

- éclairage décoratif
- réflecteur parabolique - lumière uniforme, douce et diffuse
- profilé plat d'une épaisseur de la plaque de plâtre, installation sans interférer avec la charpente du bâtiment
- montage dans les meubles, murs, plinthes avec fixations (par clic) ou directement (par vissage ou collage)



more  
information



więcej  
szczegółów



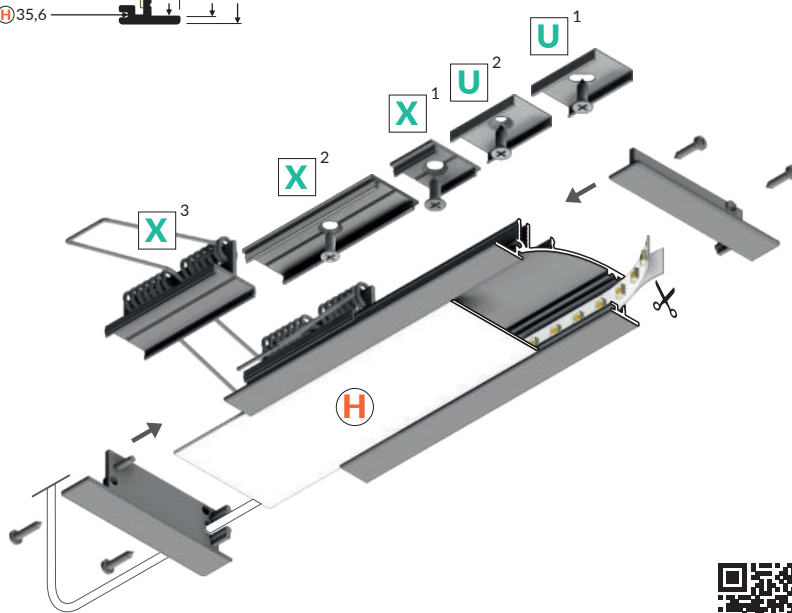
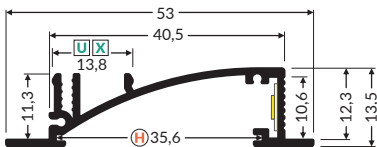

Technical manual  
Instrukcja techniczna  
Technische Anleitung  
Manuel technique



**U**<sup>1</sup> → 204

mounting plate U  
uchwyt U  
Halter U  
fixation U

**U**<sup>2</sup> → 204

mounting plate U cone  
uchwyt U cone  
Halter U cone  
fixation U cône

**X**<sup>1</sup> → 207

mounting plate X  
uchwyt X  
Halter X  
fixation X

**X**<sup>2</sup> → 207

connector X 180 deg  
łącznik X 180 st  
Verbinder X 180 Grad  
connecteur X 180 degrés

**X**<sup>3</sup> → 208

mounting plate X spring  
uchwyt X sprężyna  
Halter X Feder  
fixation X ressort

**H** → 200

diffuser H slide  
klosz H wsuwany  
Abdeckung H einschiebbar  
diffuseur H coulissant



white painted  
biały malowany  
weiß lackiert  
peint en blanc



anodized  
anodowany  
eloxiert  
surface anodisée



black anodized  
czarny anodowany  
schwarz eloxiert  
noir anodisé



raw aluminium  
surowe aluminium  
Rohaluminium  
aluminium brut

1000 mm	23040001	23040020	23040021	23040000
2000 mm	23050001	23050020	23050021	23050000
3000 mm	23200001	23200020	23200021	23200000
4050 mm	23210001	23210020	23210021	23210000

end cap FLAT8 with hole  
zaślepka FLAT8 z otworem  
Endkappe FLAT8 mit Öffnung  
embout FLAT8 avec un trou



white  
biały  
weiß  
blanc  
23110001

silver  
srebrny  
silbern  
argent  
23110040

black  
czarny  
schwarz  
noir  
23110002

grey  
szary  
grau  
gris  
23110022





# PHIL C10

## RECESSED / WPUST / EINBAU / A ENCASTRER



max 46 mm



recessed  
wpustowy  
Einbauprofile  
encastrés



architectural  
architektoniczne  
architektonisch  
architecture



lighting  
oświetleniowe  
Beleuchtungs-  
éclairage d'ambiance

- profile for creating LED luminaires
- perfect as main lighting
- 3 types of covers available with different light distributions

- profil do tworzenia opraw oświetleniowych
- doskonały jako oświetlenie główne
- dostępne 3 rodzaje kloszy o różnych rozsyłach światła

- Profil für die Erstellung von LED Leuchten
- perfekt als Hauptbeleuchtung
- 3 Arten von Abdeckungen mit unterschiedlichen Lichtverteilungen verfügbar

- profilés pour la création de luminaires LED
- un éclairage principal optimal
- 3 types de diffuseurs sont proposés avec des diffusion de la lumière différentes



more  
information



więcej  
szczegółów



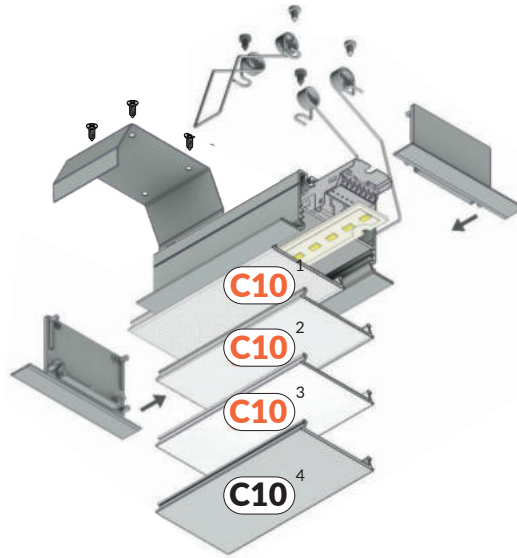
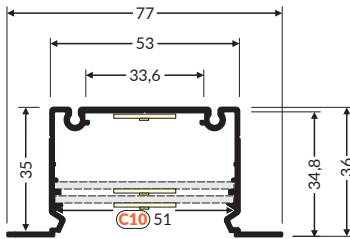

**C10**<sup>1</sup> → 197

diffuser C10 click OPAL  
klosz C10 klik OPAL  
Abdeckung C10  
einclipsbar OPAL  
diffuseur C10 clic OPAL

**C10**<sup>2</sup> → 197

diffuser C10 click NARROW  
klosz C10 klik NARROW  
Abdeckung C10  
einclipsbar NARROW  
diffuseur C10 clic NARROW

**C10**<sup>3</sup> → 197

diffuser C10 click WIDE  
klosz C10 klik WIDE  
Abdeckung C10  
einclipsbar WIDE  
diffuseur C10 clic WIDE

			
white painted biały malowany weiß lackiert peint en blanc	anodized anodowany eloxiert surface anodisée	black painted czarny malowany schwarz lackiert peint en noir	raw aluminium surowe aluminium Rohaluminium aluminium brut
1000 mm 97090001	97090020	97090002	97090000
2000 mm 97100001	97100020	97100002	97100000
3000 mm 97110001	97110020	97110002	97110000
4050 mm 97370001	97370020	97370002	97370000

end cap PHIL RECESSED  
zaślepka PHIL WPUST  
Endkappe PHIL EINBAU  
embout PHIL ENTRÉE



**C10**<sup>4</sup>

cover C10  
osłona C10  
Abdeckplatte C10  
cache C10

			
white painted biały malowany weiß lackiert peint en blanc	anodized anodowany eloxiert surface anodisée	black painted czarny malowany schwarz lackiert peint en noir	raw aluminium surowe aluminium Rohaluminium aluminium brut
1000 mm 63550001	63550020	63550002	63550000
2000 mm 63560001	63560020	63560002	63560000
3000 mm 63740001	63740020	63740002	63740000
4050 mm 63750001	63750020	63750002	63750000

white  
biały  
weiß  
blanc

silver  
srebrny  
silbern  
argent

97990001S 97990040S

black  
czarny  
schwarz  
noir

grey  
szary  
grau  
gris

97990002S 97990022S

end cap PHIL RECESSED metal  
zaślepka PHIL WPUST metal  
Endkappe PHIL EINBAU Metall  
embout PHIL ENTRÉE acier



white  
biały  
weiß  
blanc

silver  
srebrny  
silbern  
argent

97120001 97120022

black  
czarny  
schwarz  
noir

97120002

holder PHIL RECESSED  
uchwyt PHIL WPUST  
Halter PHIL EINBAU  
fixation PHIL ENTRÉE



material: stainless steel  
materiał: stal nierdzewna  
Material: Rostfreier Stahl  
matériel: inox

97510019

holder PHIL RECESSED spring  
uchwyt PHIL WPUST sprężyna  
Halter PHIL EINBAU Feder  
fixation PHIL ENTRÉE ressort



material: zinc coated steel  
materiał: stal ocynkowana  
Material: Verzinkter Stahl  
matériel: acier galvanisé

97520030





**CORNER  
KĄTOWE  
ECKPROFILE  
D'ANGLES**





# QUARTER10 BD/U6



max 10 mm



corner  
kątowy  
Eckprofile  
d'angles



furniture  
meblowe  
Möbel-  
mobilier

- full circle quadrant illumination
- LED strip aligned to 45° angle
- Slick socket

- pełne oświetlenie ćwiartki koła
- taśma ustawiona pod kątem 45 stopni
- gniazdo Slick

- volle Beleuchtung eines Quadrants
- der Streifen unter dem Winkel von 45 Grad eingestellt
- Sockel mit Slick Funktion

- éclairage complet du quart de cercle
- installation de ruban à un angle de 45 degrés
- prise avec fonction Slick



more  
information



więcej  
szczegółów





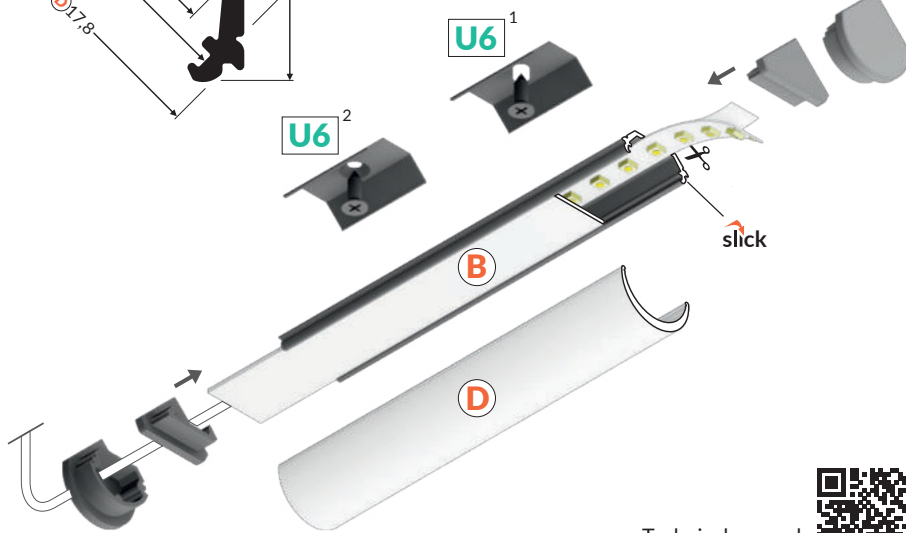
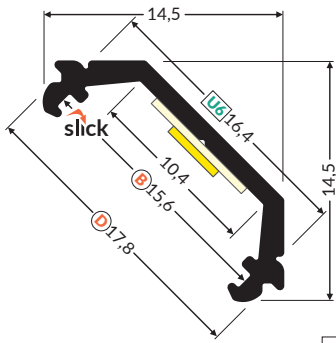

Technical manual  
Instrukcja techniczna  
Technische Anleitung  
Manuel technique



**U6**<sup>1</sup> → 206

mounting plate U6  
uchwyt U6  
Halter U6  
fixation U6

**U6**<sup>2</sup> → 206

mounting plate U6 cone  
uchwyt U6 cone  
Halter U6 cone  
fixation U6 cône

**B** → 194

diffuser B slide  
klosz B wsuwany  
Abdeckung B einschiebbar  
diffuseur B coulissant

**D** → 198

diffuser D click  
klosz D klik  
Abdeckung D einclipsbar  
diffuseur D clic

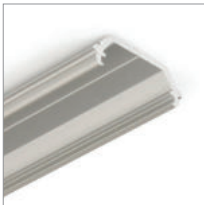

anodized  
anodowany  
eloxiert  
surface anodisée

1000 mm	<b>D3010020</b>
2000 mm	<b>D3020020</b>
3000 mm	<b>D3030020</b>
4050 mm	<b>D3040020</b>

end cap QUARTER10  
zaślepka QUARTER10  
Endkappe QUARTER10  
embout QUARTER10



silver  
srebrny  
silbern  
argent  
**D3980040**

grey  
szary  
grau  
gris  
**D3980022**

end cap QUARTER10 D  
zaślepka QUARTER10 D  
Endkappe QUARTER10 D  
embout QUARTER10 D



silver  
srebrny  
silbern  
argent  
**D3990040**

grey  
szary  
grau  
gris  
**D3990022**

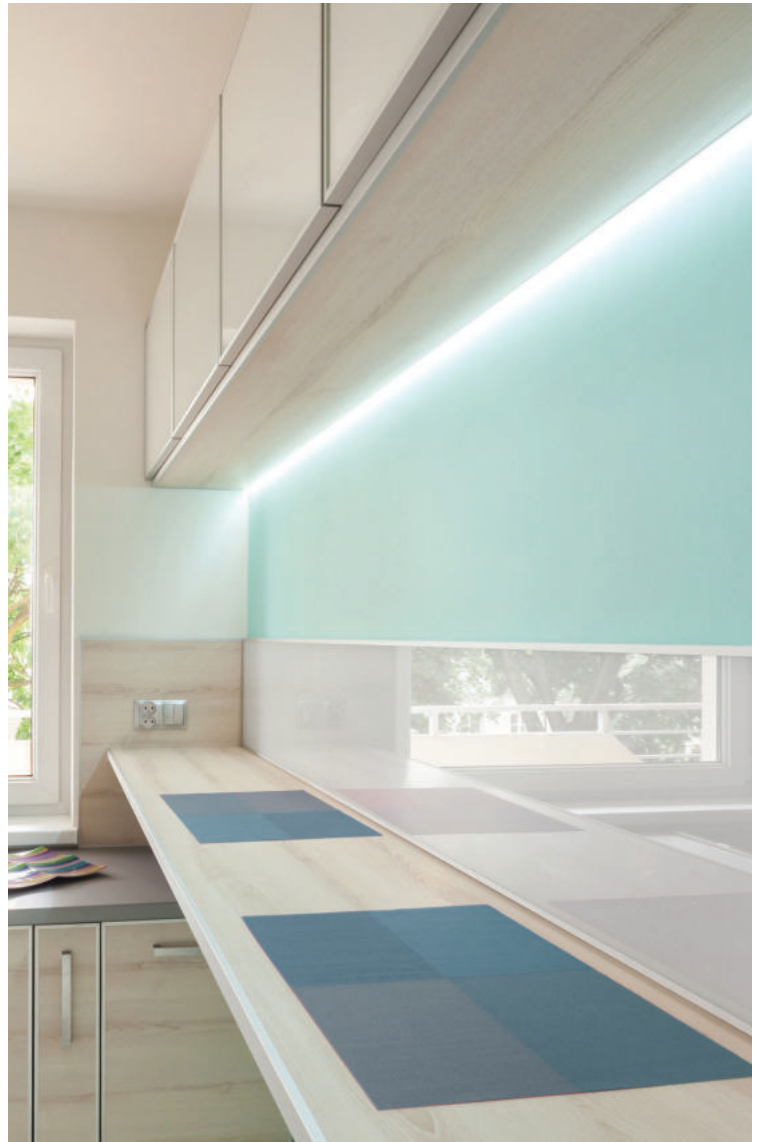



max 12 mm



corner  
kątowy  
Eckprofile  
d'angles



furniture  
mebłowe  
Möbel-  
mobilier

- two lighting angles: 30°/60°
- small sizes, no holders and a channel for hiding cables
- minimum interference in glass show case's look
- Slick socket

- dwa kąty świecenia: 30°/60°
- niewielkie gabaryty, brak uchwytów oraz kanał do schowania przewodów
- minimalna ingerencja w wygląd szklanej gabloty
- gniazdo z funkcją Slick

- zwei Beleuchtungswinkel 30° und 60°
- Miniaturbaumasse, keine Halter und ein Kanal zum Leitungsverstecken
- minimaler Eingriff in das Aussehen der Glasvitrine
- Sockel mit Slick Funktion

- deux angles d'éclairage : 30°/60°
- petites dimensions, pas de fixations et un canal pour cacher les câbles
- profilé discret qui se fond dans la vitrine
- prise avec fonction Slick



more  
information



więcej  
szczegółów



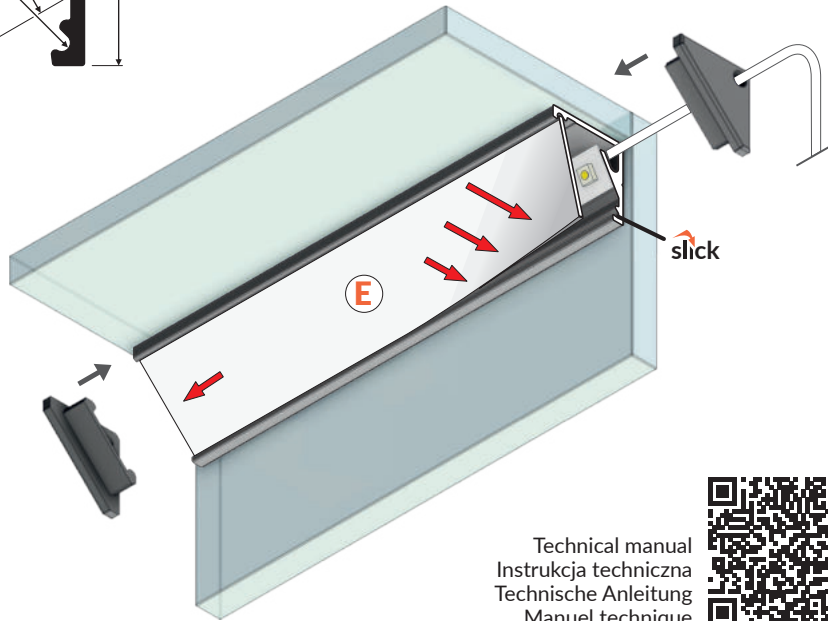
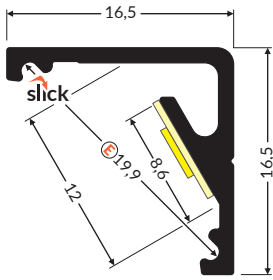

Technical manual  
Instrukcja techniczna  
Technische Anleitung  
Manuel technique



**E** → 198

diffuser E slide  
klosz E wsuwany  
Abdeckung E einschiebbar  
diffuseur E coulissant



white painted  
biały malowany  
weiß lackiert  
peint en blanc



anodized  
anodowany  
eloxiert  
surface anodisée

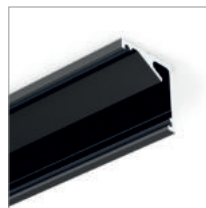

black anodized  
czarny anodowany  
schwarz eloxiert  
noir anodisé

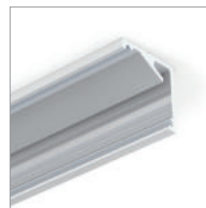

raw aluminium  
surowe aluminium  
Rohaluminium  
aluminium brut

1000 mm	<b>C9010001</b>	<b>C9010020</b>	<b>C9010021</b>	<b>C9010000</b>
2000 mm	<b>C9020001</b>	<b>C9020020</b>	<b>C9020021</b>	<b>C9020000</b>
3000 mm	<b>C9030001</b>	<b>C9020020</b>	<b>C9030021</b>	<b>C9030000</b>
4050 mm	<b>C9040001</b>	<b>C9040020</b>	<b>C9040021</b>	<b>C9040000</b>

end cap CABI12  
zaślepka CABI12  
Endkappe CABI12  
embout CABI12

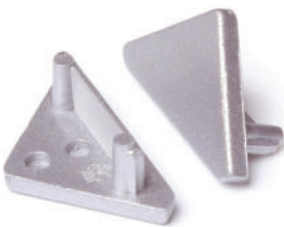

white biały weiß blanc	silver srebrny silbern argent
<b>C9980001</b>	<b>C9980040</b>

black czarny schwarz noir	grey szary grau gris
<b>C9980002</b>	<b>C9980022</b>



# CABI12 DUO E



max 12 mm



corner  
kątowy  
Eckprofile  
d'angles



furniture  
meblowe  
Möbel-  
mobilier

- designed for displaying products in glass cases
- two places to insert the LED strip
- minimalist, unobtrusive
- much lighter than the original

- zaprojektowany do ekspozycji produktów w szklanych gablotach
- dwa miejsca na wklejenie taśmy LED
- minimalistyczny, dyskretny
- dużo lżejszy od pierwowzoru

- entwickelt für die Präsentation von Waren in Glasvitrinen
- zwei Plätze fürs Einkleben von LED-Streifen
- minimalistisch, diskret
- viel leichter als der Prototyp

- conçu pour présenter les produits dans les vitrines
- deux endroits pour coller le ruban LED
- minimaliste, discret
- beaucoup plus léger que l'original



more  
information



więcej  
szczegółów

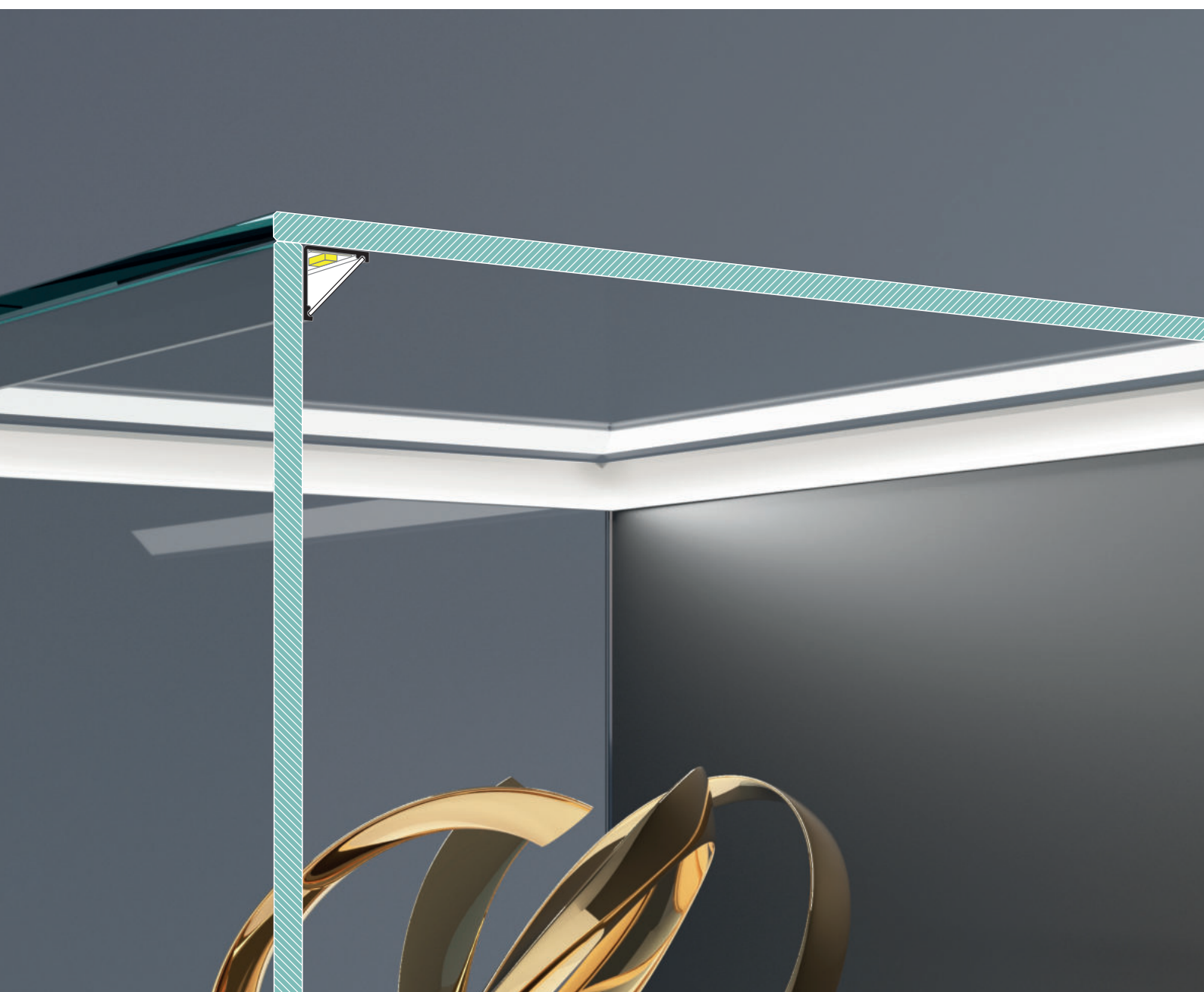

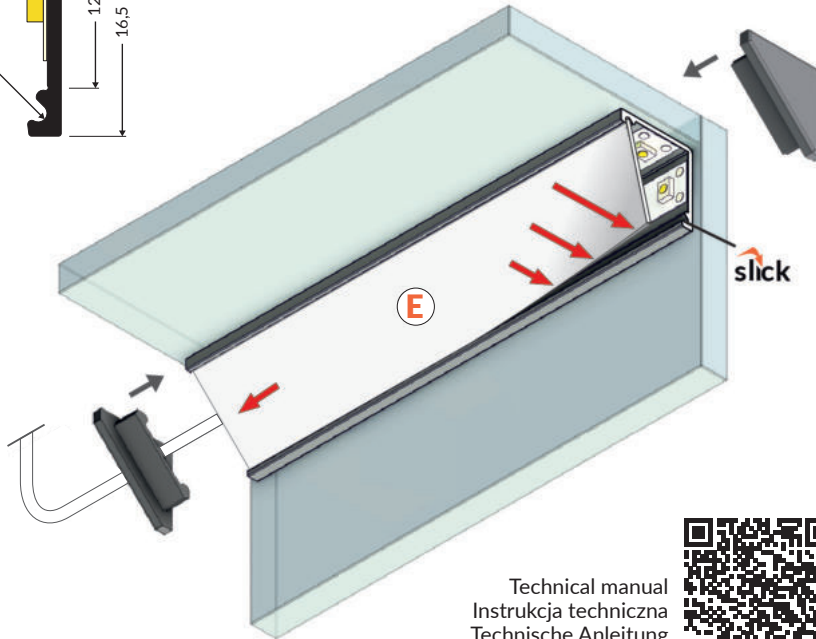
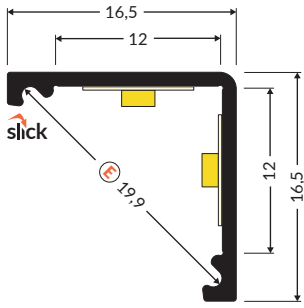

Technical manual  
Instrukcja techniczna  
Technische Anleitung  
Manuel technique



**E** → 198

diffuser E slide  
klosz E wsuwany  
Abdeckung E einschiebbar  
diffuseur E coulissant



white painted  
biały malowany  
weiß lackiert  
peint en blanc



anodized  
anodowany  
eloxiert  
surface anodisée



black anodized  
czarny anodowany  
schwarz eloxiert  
noir anodisé



raw aluminium  
surowe aluminium  
Rohaluminium  
aluminium brut

1000 mm	K2000101	K2000120	K2000121	K2000100
2000 mm	K2000201	K2000220	K2000221	K2000200
3000 mm	K2000301	K2000320	K2000321	K2000300
4050 mm	K2000401	K2000420	K2000421	K2000400

end cap CABI12  
zaślepka CABI12  
Endkappe CABI12  
embout CABI12

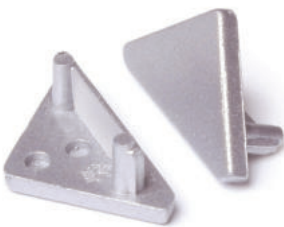

white  
biały  
weiß  
blanc  
C9980001

silver  
srebrny  
silbern  
argent  
C9980040

black  
czarny  
schwarz  
noir  
C9980002

grey  
szary  
grau  
gris  
C9980022



# CORNER10 BC/UX



max 10 mm



corner  
kątowy  
Eckprofile  
d'angles



furniture  
meblowe  
Möbel-  
mobilier

- lighting directions: 30° or 60°
- hidden mounting
- wide range of accessories,  
7 types of diffusers

- dwa kąty świecenia: 30° i 60°
- ukryte mocowanie
- szeroki wybór akcesoriów,  
7 rodzajów kloszy

- zwei Beleuchtungswinkel  
30° und 60°
- eine versteckte Befestigung
- eine breite Zubehörwahl,  
7 Arten der Abdeckungen

- deux angles  
d'éclairage : 30 ° et 60 °
- fixation cachée
- large gamme d'accessoires,  
7 types de diffuseurs



more  
information



więcej  
szczegółów





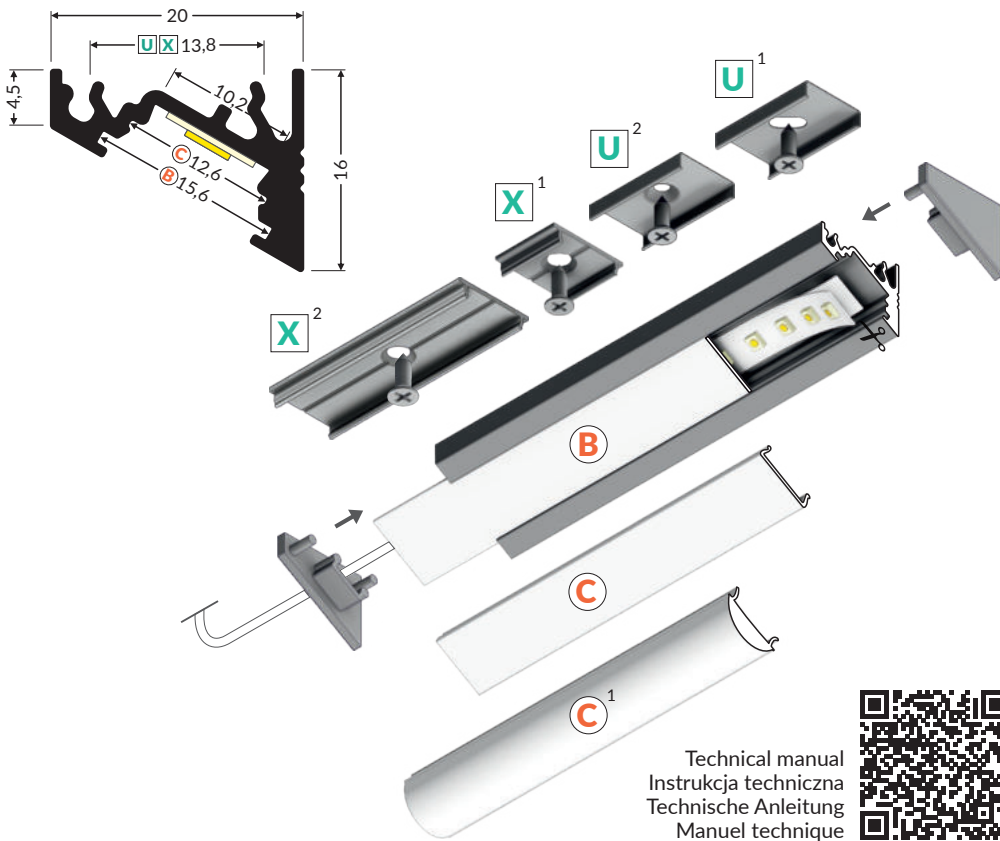

**U**<sup>1</sup> → 204

mounting plate U  
uchwyt U  
Halter U  
fixation U

**U**<sup>2</sup> → 204

mounting plate U cone  
uchwyt U cone  
Halter U cone  
fixation U cône

**X**<sup>1</sup> → 207

mounting plate X  
uchwyt X  
Halter X  
fixation X

**X**<sup>2</sup> → 207

connector X 180 deg  
łącznik X 180 st  
Verbinder X 180 Grad  
connecteur X 180 degrés

**B** → 194

diffuser B slide  
klosz B wsuwany  
Abdeckung B einziehbar  
diffuseur B coulissant

**C** → 195

diffuser C click  
klosz C klik  
Abdeckung C einclipsbar  
diffuseur C clic

**C**<sup>1</sup> → 195

diffuser C click lens gen2  
klosz C klik soczewka gen2  
Abdeckung C einclipsbar Linse gen2  
diffuseur C clic lentille gen 2

white painted biały malowany weiß lackiert peint en blanc	anodized anodowany eloxiert surface anodisée	black anodized czarny anodowany schwarz eloxiert noir anodisé	raw aluminium surowe aluminium Rohaluminium aluminium brut
1000 mm <b>83040001</b>	<b>83040020</b>	<b>83040021</b>	<b>83040000</b>
2000 mm <b>83050001</b>	<b>83050020</b>	<b>83050021</b>	<b>83050000</b>
3000 mm <b>83180001</b>	<b>83180020</b>	<b>83170021</b>	<b>83180000</b>
4050 mm <b>83190001</b>	<b>83190020</b>	<b>83190021</b>	<b>83190000</b>

end cap CORNER10 gen2  
zaślepka CORNER10 gen2  
Endkappe CORNER10 gen2  
embout CORNER10 gen2

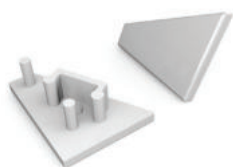

white biały weiß blanc	silver srebrny silbern argent
<b>83990001</b>	<b>83990040</b>

black czarny schwarz noir	grey szary grau gris
<b>83990002</b>	<b>83990022</b>

end cap CORNER10 gen2 with hole  
zaślepka CORNER10 gen2 z otworem  
Endkappe CORNER10 gen2 mit Öffnung  
embout CORNER10 gen2 avec un trou



white biały weiß blanc	silver srebrny silbern argent
<b>83980001</b>	<b>83980040</b>

black czarny schwarz noir	grey szary grau gris
<b>83980002</b>	<b>83980022</b>

connector CORNER10 90 deg  
łącznik CORNER10 90 st  
Verbinder CORNER10 90 Grad  
connecteur CORNER10 90 degrés

white painted  
biały malowany  
weiß lackiert  
peint en blanc  
**83110001**

anodized  
anodowany  
eloxiert  
surface anodisée  
**83110020**

black anodized  
czarny anodowany  
schwarz eloxiert  
noir anodisé  
**83110021**

material: aluminium  
material: aluminium  
Material: Aluminium  
matériel: aluminium

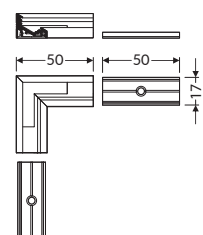

# CORNER10.v2 A1C/U1



max 10 mm



corner  
kątowy  
Eckprofile  
d'angles



furniture  
meblowe  
Möbel-  
mobilier

- a new generation of corner profiles
- effective design
- reduced weight (30% lighter than predecessor)
- updated design

- nowa generacja profili kątowych
- efektywna konstrukcja
- zredukowana waga (30% lżejszy od poprzednika)
- odświeżony design

- neue Generation von Eckprofilen
- effektive Konstruktion
- reduziertes Gewicht (30% leichter als Vorgänger)
- aufgefrishtes Design

- nouvelle génération de profilés d'angle
- construction efficace
- poids réduit (30% plus léger de son prédécesseur)
- design rafraîchi



more  
information



więcej  
szczegółów



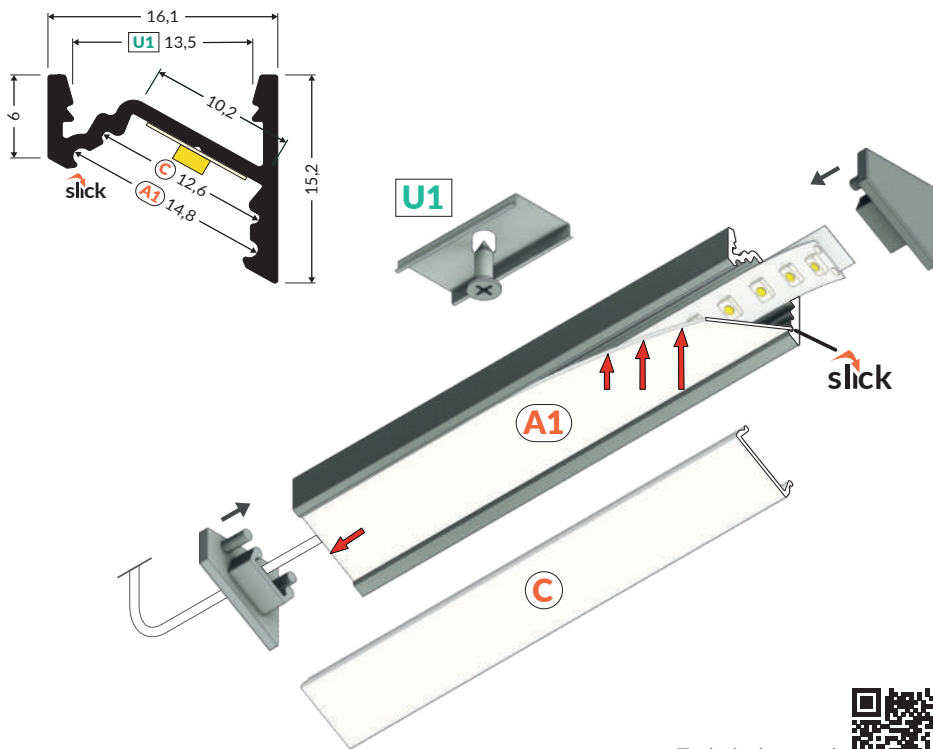

**U1** → 205

mounting plate U1  
uchwyt U1  
Halter U1  
fixation U1

**A1** → 194





diffuser A1 slide  
klosz A1 wsuwany  
Abdeckung A1 einschiebbar  
diffuseur A1 coulissant

**C** → 195

diffuser C click  
klosz C klik  
Abdeckung C einclipsbar  
diffuseur C clic

Technical manual  
Instrukcja techniczna  
Technische Anleitung  
Manuel technique



			
white painted biały malowany weiß lackiert peint en blanc	anodized anodowany eloxiert surface anodisée	black anodized czarny anodowany schwarz eloxiert noir anodisé	raw aluminium surowe aluminium Rohaluminium aluminium brut
1000 mm	J6000101	J6000120	J6000100
2000 mm	J6000201	J6000220	J6000200
3000 mm	J6000301	J6000320	J6000300
4050 mm	J6000401	J6000420	J6000400

end cap CORNER10.v2  
zaślepka CORNER10.v2  
Endkappe CORNER10.v2  
embout CORNER10.v2



white biały weiß blanc	silver srebrny silbern argent
<b>J6999901</b>	<b>J6999940</b>

black czarny schwarz noir	grey szary grau gris
<b>J6999902</b>	<b>J6999922</b>



# CORNER14 EE7F/TY



max 14mm



corner  
kątowy  
Eckprofile  
d'angles



furniture  
meblowe  
Möbel-  
mobilier

- hidden mounting  
- two lighting angles: 30°/60°

- ukryte mocowanie  
- dwa kąty świecenia: 30°/60°

- eine versteckte Befestigung  
- zwei Beleuchtungswinkel  
30° und 60°

- fixation cachée  
- deux angles d'éclairage:  
30° / 60°



more  
information



więcej  
szczegółów



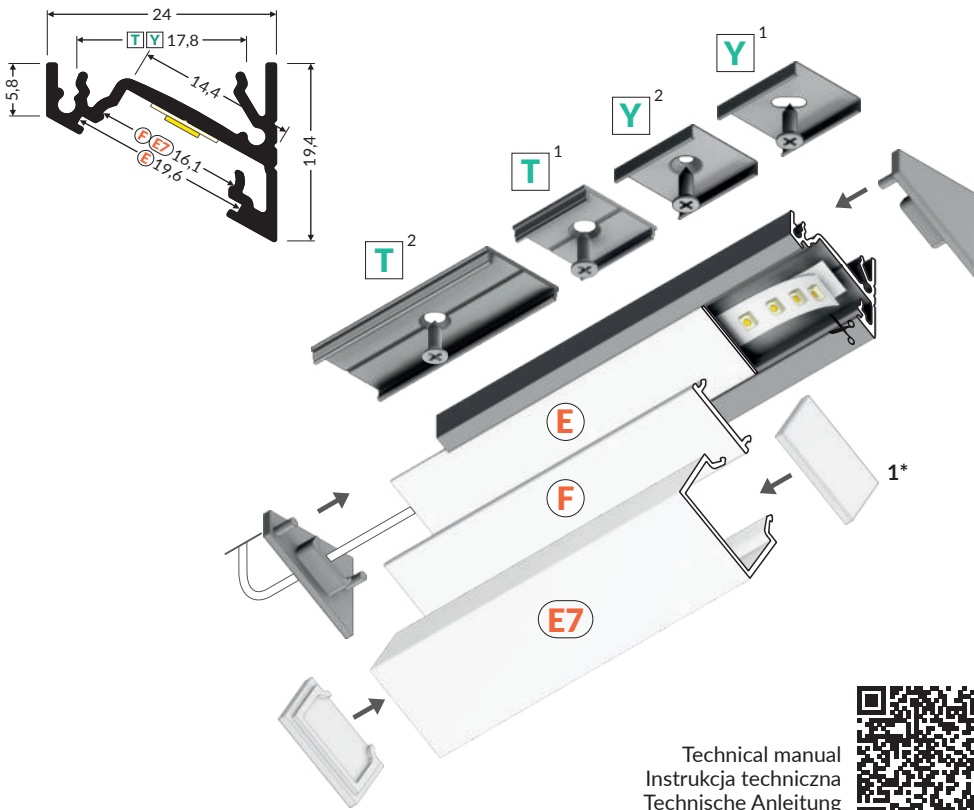

**Y<sup>1</sup>** → 208

mounting plate Y  
uchwyt Y  
Halter Y  
fixation Y

**Y<sup>2</sup>** → 208

mounting plate Y cone  
uchwyt Y cone  
Halter Y cone  
fixation Y cône

**T<sup>1</sup>** → 204

mounting plate T  
uchwyt T  
Halter T  
fixation T

**T<sup>2</sup>** → 204

connector T 180 deg  
łącznik T 180 st  
Verbinder T 180 Grad  
connecteur T 180 degrés

**E** → 198

diffuser E slide  
klosz E wsuwany  
Abdeckung E einziehbar  
diffuseur E coulissant

**F** → 199

diffuser F click  
klosz F klik  
Abdeckung F einclipsbar  
diffuseur F clic

**E7** → 198

diffuser E7 click  
klosz E7 klik  
Abdeckung E7 einclipsbar  
diffuseur E7 clic

**1\*** → 198

end cap E7  
zaślepka E7  
Endkappe E7  
embout E7

Technical manual  
Instrukcja techniczna  
Technische Anleitung  
Manuel technique



white painted biały malowany weiß lackiert peint en blanc	anodized anodowany eloxiert surface anodisée	black anodized czarny anodowany schwarz eloxiert noir anodisé	raw aluminium surowe aluminium Rohaluminium aluminium brut
1000 mm <b>A4010001</b>	<b>A4010020</b>	<b>A4010021</b>	<b>A4010000</b>
2000 mm <b>A4020001</b>	<b>A4020020</b>	<b>A4020021</b>	<b>A4020000</b>
3000 mm <b>A4100001</b>	<b>A4100020</b>	<b>A4100021</b>	<b>A4100000</b>
4050 mm <b>A4110001</b>	<b>A4110020</b>	<b>A4110021</b>	<b>A4110000</b>

end cap CORNER14 gen2  
zaślepka CORNER14 gen2  
Endkappe CORNER14 gen2  
embout CORNER14 gen2

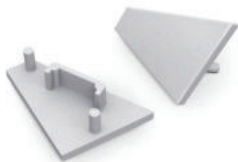

white biały weiß blanc	silver srebrny silbern argent	<b>A4980001</b>	<b>A4980040</b>
black czarny schwarz noir	grey szary grau gris	<b>A4980002</b>	<b>A4980022</b>

end cap CORNER14 gen2 with hole  
zaślepka CORNER14 gen2 z otworem  
Endkappe CORNER14 gen2 mit Öffnung  
embout CORNER14 gen2 avec un trou



white biały weiß blanc	silver srebrny silbern argent	<b>A4970001</b>	<b>A4970040</b>
black czarny schwarz noir	grey szary grau gris	<b>A4970002</b>	<b>A4970022</b>

connector CORNER14 90 deg  
łącznik CORNER14 90 st  
Verbinder CORNER14 90 Grad  
connecteur CORNER14 90 degrés

white painted  
biały malowany  
weiß lackiert  
peint en blanc  
**A4990001**

anodized  
anodowany  
eloxiert  
surface anodisée  
**A4990020**

black anodized  
czarny anodowany  
schwarz eloxiert  
noir anodisé  
**A4990021**

material: aluminium  
materiał: aluminium  
Material: Aluminium  
matériel: aluminium

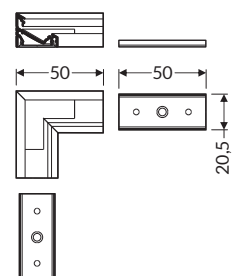



# CORNER 12.v2 EF/U



max 12 mm



corner  
kątowy  
Eckprofile  
d'angles



furniture  
meblowe  
Möbel-  
mobilier

- a new generation of angle profiles
- effective design
- reduced weight
- updated design

- nowa generacja profili kątowych
- efektywna konstrukcja
- zredukowana waga
- odświeżony design

- neue Generation von Eckprofilen
- effektive Konstruktion
- reduziertes Gewicht
- aufgefrishtes Design

- nouvelle génération de profilés d'angle
- construction efficace
- poids réduit
- design rafraîchi



more  
information



więcej  
szczegółów





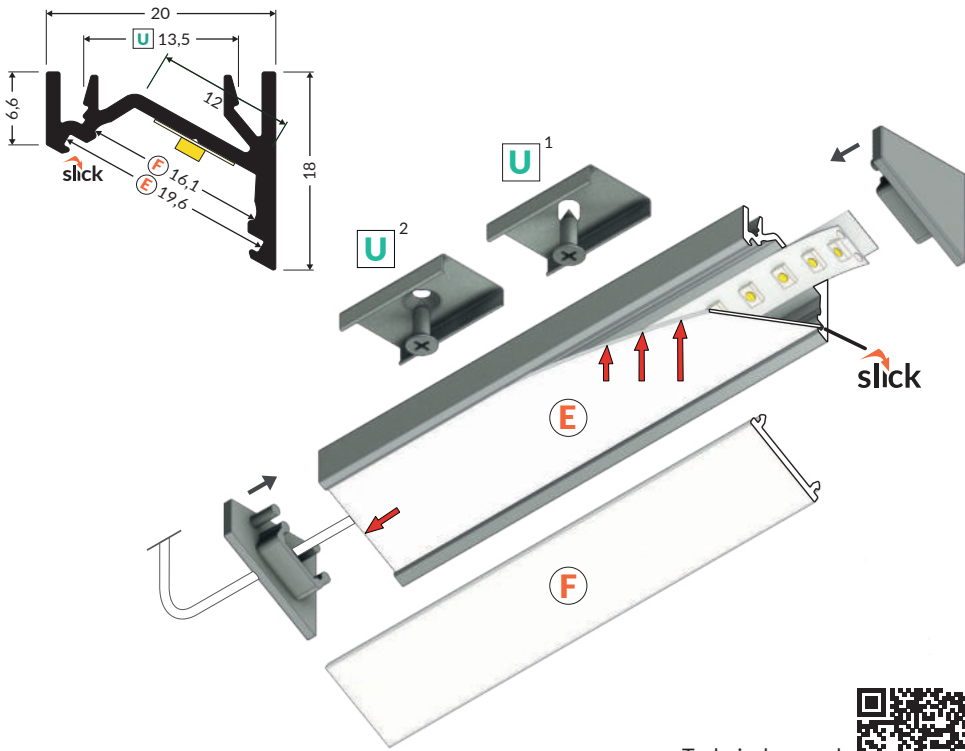

Technical manual  
Instrukcja techniczna  
Technische Anleitung  
Manuel technique



**U**<sup>1</sup> → 204

mounting plate U  
uchwył U  
Halter U  
fixation U

**U**<sup>2</sup> → 204

mounting plate U cone  
uchwył U cone  
Halter U cone  
fixation U cône

**E** → 198

diffuser E slide  
klosz E wsuwany  
Abdeckung E einschiebbar  
diffuseur E coulissant

**F** → 199

diffuser F click  
klosz F klik  
Abdeckung F einclipsbar  
diffuseur F clic



white painted  
biały malowany  
weiß lackiert  
peint en blanc



anodized  
anodowany  
eloxiert  
surface anodisée



black anodized  
czarny anodowany  
schwarz eloxiert  
noir anodisé



raw aluminium  
surowe aluminium  
Rohaluminium  
aluminium brut

1000 mm	J7000101	J7000120	J7000121	J7000100
2000 mm	J7000201	J7000220	J7000221	J7000200
3000 mm	J7000301	J7000320	J7000321	J7000300
4050 mm	J7000401	J7000420	J7000421	J7000400

end cap CORNER12.v2  
zaślepka CORNER12.v2  
Endkappe CORNER12.v2  
embout CORNER12.v2

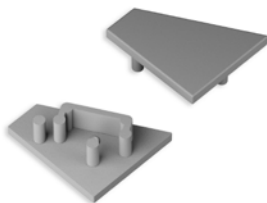

white  
biały  
weiß  
blanc  
J7999901

silver  
srebrny  
silbern  
argent  
J7999940

black  
czarny  
schwarz  
noir  
J7999902

grey  
szary  
grau  
gris  
J7999922









**PLASTER-IN  
DO SZPACHLOWANIA  
ZUM SPACHTELN  
POUR LE REMPLISSAGE**







max 10 mm



plaster-in  
do szpachlowania  
zum Spachteln  
pour le remplissage



architectural  
architektoniczne  
architektonisch  
architecture

- decorative lighting, invisible profile and diffuser
- profile for finishing of plasterboards with a minimum thickness of 12,5 mm
- many possible arrangements
- Slick socket

- oświetlenie dekoracyjne, niewidoczny profil i klosz
- profil do wykończenia płyty kartonowo-gipsowej o minimalnej grubości 12,5 mm
- wiele możliwych aranżacji
- gniazdo Slick

- dekorative Beleuchtung, unsichtbares Profil und Abdeckung
- Profil für die Endbearbeitung von Gipskartonplatten mit einer Mindestdicke von 12,5 mm
- viele Gestaltungsmöglichkeiten
- Slick Socket

- éclairage décoratif, profilé et diffuseur invisibles
- profilé pour la finition des cloisons sèches d'une épaisseur minimale de 12,5 mm
- de nombreux aménagements possibles
- prise avec fonction Slick



more information



więcej szczegółów

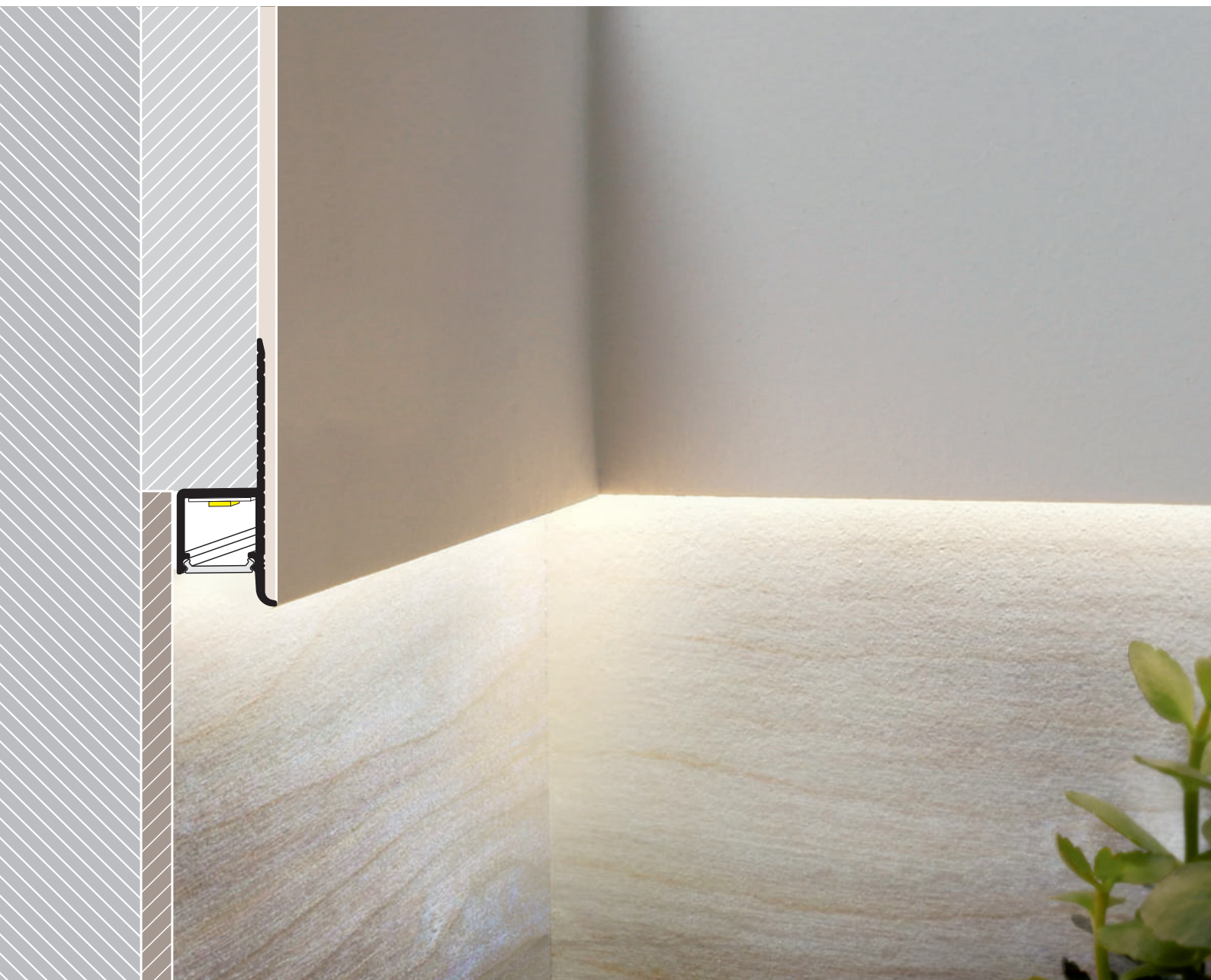

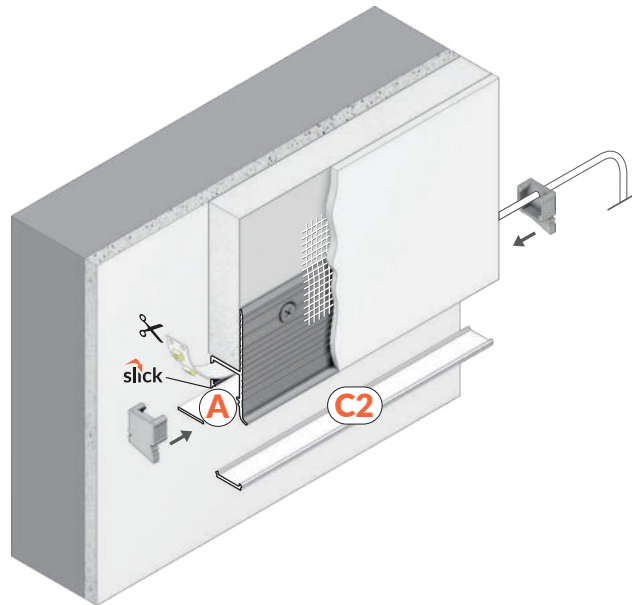
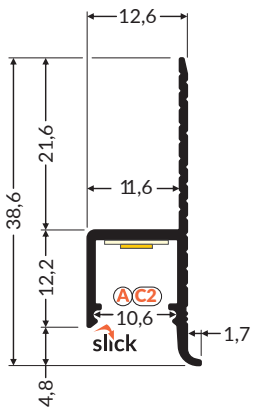

**A** → 194

diffuser A slide  
klosz A wsuwany  
Abdeckung A einschiebbar  
diffuseur A coulissant

**C2** → 196

diffuser C2 click  
klosz C2 klik  
Abdeckung C2 einclipsbar  
diffuseur C2 clic

Technical manual  
Instrukcja techniczna  
Technische Anleitung  
Manuel technique

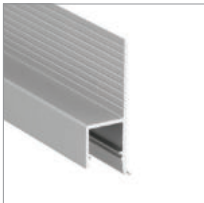

anodized  
anodowany  
eloxiert  
surface anodisée



raw aluminium  
surowe aluminium  
Rohaluminium  
aluminium brut

1000 mm	<b>H4000120</b>	<b>H4000100</b>
2000 mm	<b>H4000220</b>	<b>H4000200</b>
3000 mm	<b>H4000320</b>	<b>H4000300</b>
4050 mm	<b>H4000420</b>	<b>H4000400</b>

end cap OMNI10  
zaślepka OMNI10  
Endkappe OMNI10  
embout OMNI10

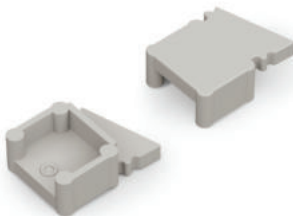

grey  
szary  
grau  
gris  
**H4999922**



# OMNI10 AC2

EXAMPLES OF POSSIBILITIES  
PRZYKŁADOWE MOŻLIWOŚCI  
BEISPIELSMÖGLICHKEITEN  
EXEMPLES DE POSSIBILITÉS

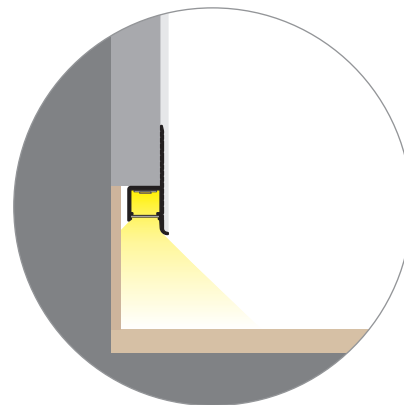
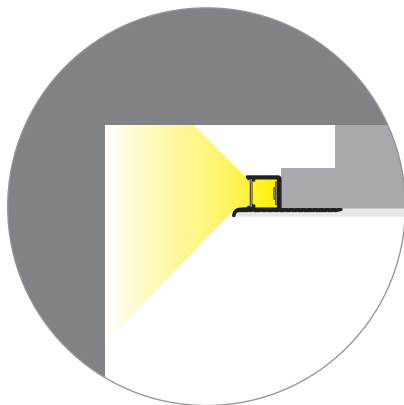
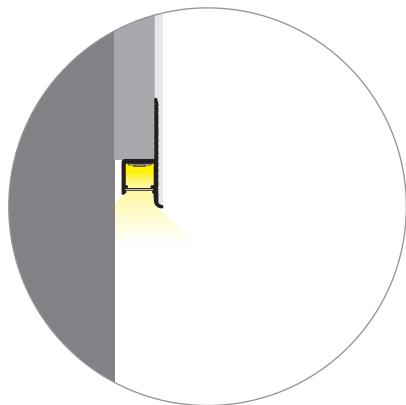

The OMNI10 LED profile can be used in a variety of contexts and it illuminates surfaces with a variety of materials: whether it's a plain painted wall, wallpaper or wooden surfaces.

Profil LED OMNI10 można użyć w różnych kontekstach i oświetlić nim powierzchnie wykończone różnymi materiałami: zarówno gładko pomalowaną ścianę, jak i tapetę czy powierzchnie drewniane.

Das OMNI10 LED Profil kann man in verschiedenen Kontexten einsetzen und damit Oberflächen, die mit unterschiedlichen Materialien fertiggestellt sind, beleuchten: Sowohl glatt gestrichene Wand als auch eine Tapete oder Holzoberflächen.

Le profilé LED OMNI10 peut être utilisé dans divers contextes et illumine les surfaces finies avec divers matériaux; à la fois un mur peint et un papier peint ou des surfaces en bois.



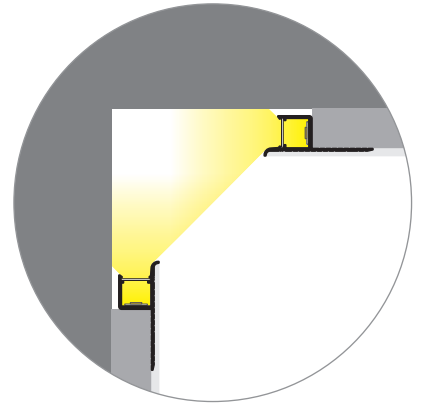
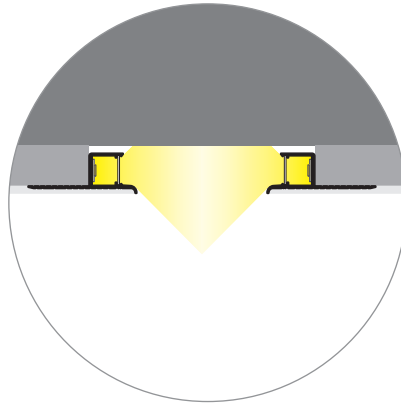
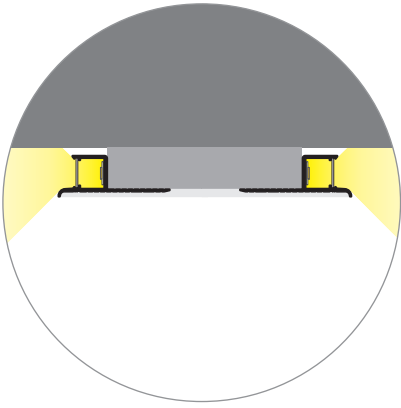

# GLOW12 UP A1C



max 12 mm

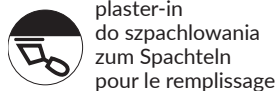

plaster-in  
do szpachlowania  
zum Spachteln  
pour le remplissage



architectural  
architektoniczne  
architektonisch  
architecture

- for finishing suspended ceilings  
- a gentle glow of light on the actual ceiling  
- easy and aesthetically pleasing finish to the edges

- do wykańczania sufitów podwieszanych  
- delikatna łuna światła na sufit właściwy  
- łatwe i estetyczne wykończenie krawędzi sufitu podwieszanego  
- do płyty gk o grubości 12,5 mm

- für Fertigstellung von Hängedecken  
- sanfter Lichtschimmer auf die eigentliche Decke  
- einfache und ästhetische Fertigstellung der Kante von Hängedecke  
- für Gipskartonplatten mit einer Dicke von 12,5 mm

- pour la finition des faux plafonds  
- douce lueur sur le plafond  
- finition facile et esthétique du bord du faux plafond  
- pour une plaque de plâtre d'une épaisseur de 12,5 mm

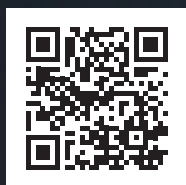
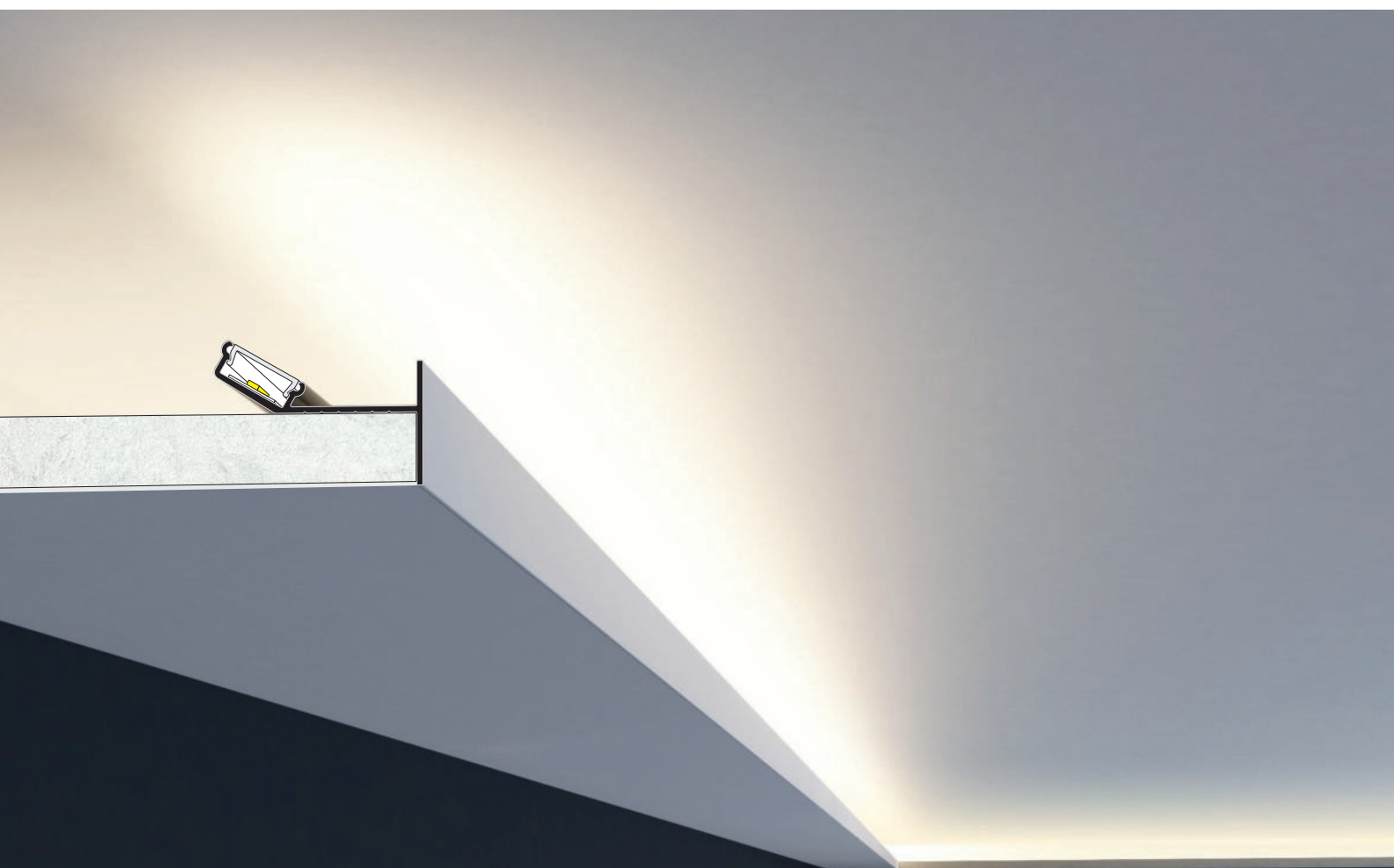

more information

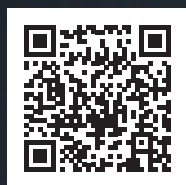

więcej szczegółów

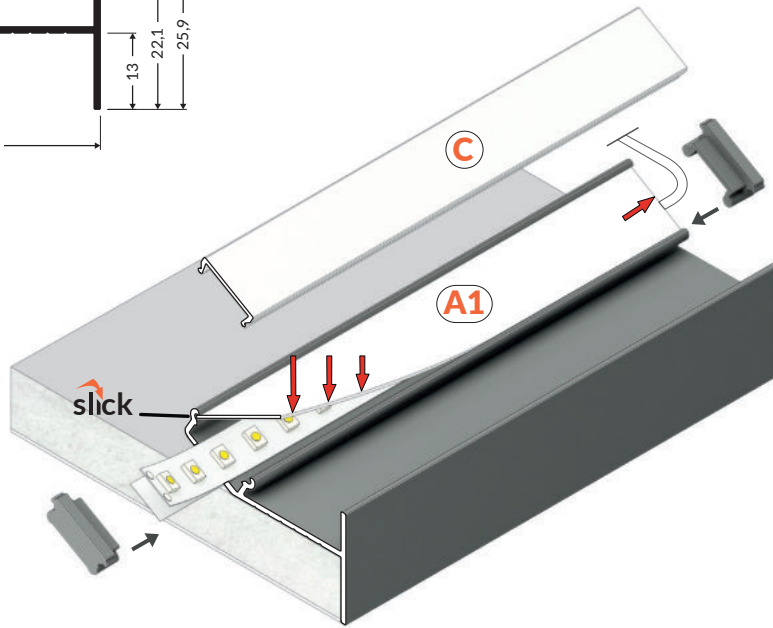
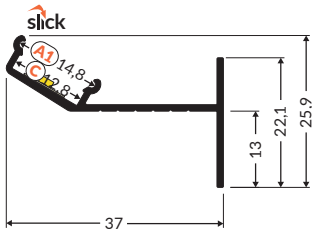

**A1** → 194

diffuser A1 slide  
klosz A1 wsuwany  
Abdeckung A1 einschiebbar  
diffuseur A1 coulissant

**C** → 195

diffuser C click  
klosz C klik  
Abdeckung C einclipsbar  
diffuseur C clic



white painted  
biały malowany  
weiß lackiert  
peint en blanc



anodized  
anodowany  
eloxiert  
surface anodisée



raw aluminium  
surowe aluminium  
Rohaluminium  
aluminium brut

1000 mm	K8000101	K8000120	K8000100
2000 mm	K8000201	K8000220	K8000200
3000 mm	K8000301	K8000320	K8000300
4050 mm	K8000401	K8000420	K8000400

end cap GLOW12  
zaślepka GLOW12  
Endkappe GLOW12  
embout GLOW12

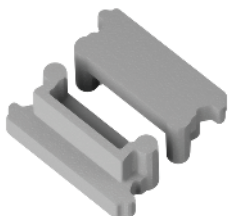

grey  
szary  
grau  
gris  
K7999922



# GLOW12 DOWN A1C



max 12 mm



plaster-in  
do szpachlowania  
zum Spachteln  
pour le remplissage



architectural  
architektoniczne  
architektonisch  
architecture

- for finishing suspended ceilings
- a gentle glow of light on the wall
- easy and aesthetically pleasing finish to the edges of a suspended ceiling
- for 12.5 mm thick plasterboard

- do wykańczania sufitów podwieszanych
- delikatna łuna światła na ścianę
- łatwe i estetyczne wykończenie krawędzi sufitu podwieszanego
- do płyty gk o grubości 12,5 mm

- für Fertigstellung von Hängedecken
- sanfter Lichtschimmer an der Wand
- einfache und ästhetische Fertigstellung der Kante von Hängedecke
- für Gipskartonplatten mit einer Dicke von 12,5 mm

- pour la finition des faux plafonds
- douce lueur sur le mur
- finition facile et esthétique du bord du faux plafond
- pour une plaque de plâtre d'une épaisseur de 12,5 mm

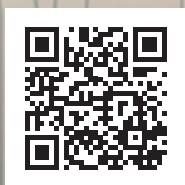

more  
information



więcej  
szczegółów

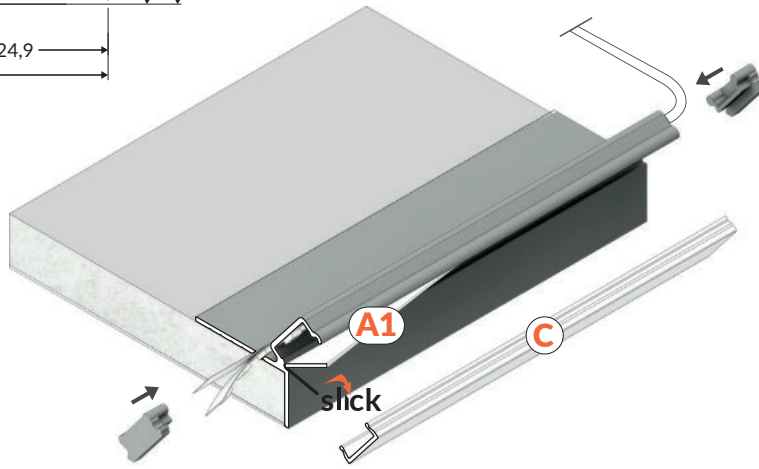
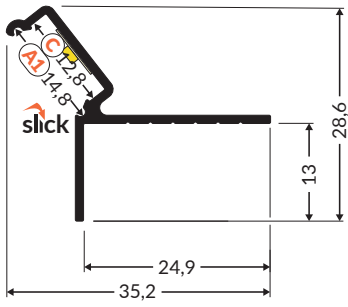

**A1** → 194

diffuser A1 slide  
klosz A1 wsuwany  
Abdeckung A1 einschiebbar  
diffuseur A1 coulissant

**C** → 195

diffuser C click  
klosz C klik  
Abdeckung C einclipsbar  
diffuseur C clic



anodized  
anodowany  
eloxiert  
surface anodisée



raw aluminium  
surowe aluminium  
Rohaluminium  
aluminium brut

1000 mm	K7000120	K7000100
2000 mm	K7000220	K7000200
3000 mm	K7000320	K7000300
4050 mm	K7000420	K7000400

end cap GLOW12  
zaślepka GLOW12  
Endkappe GLOW12  
embout GLOW12

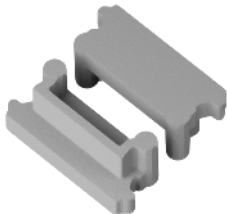

grey  
szary  
grau  
gris  
K7999922

# FRAME14 BC/Q

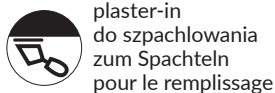

- dedicated for plasterboards - decorative construction finish
- continuous line of light (when using LED strip 120 P/m and opal diffuser)
- multiple arrangements through a variety of connectors

- dedykowany do płyt kartonowo-gipsowych - dekoracyjne wykończenie konstrukcji
- ciągła linia światła (przy zastosowaniu taśmy 120 P/m i klosza mlecznego)
- wiele możliwości aranżacyjnych dzięki różnorodnym łącznikom

- vorgesehen für Rigipsplatten - eine dekorative Ausführung der Konstruktion
- eine homogene Lichtlinie (unter Verwendung von LED Streifen mit 120 leds/m und einer opalen Abdeckung)
- viele Anwendungsmöglichkeiten mit Hilfe von unterschiedlichen Verbindern

- dédié aux plaques de plâtre - finition décorative de la structure
- une ligne continue de lumière (en utilisant un strip 120 P/m et un diffuseur opaque)
- de nombreuses possibilités d'agencement grâce à différents modèles de connecteurs



more  
information



więcej  
szczegółów

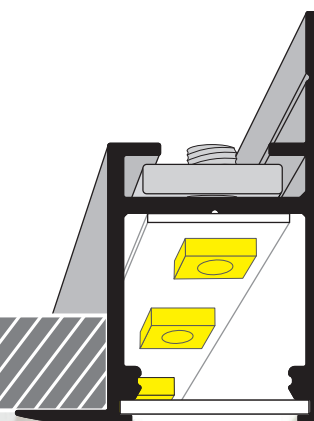



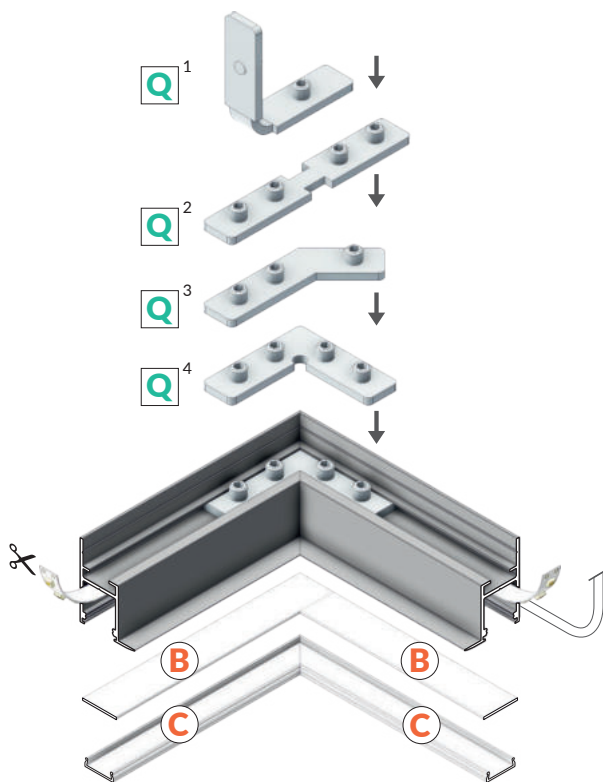
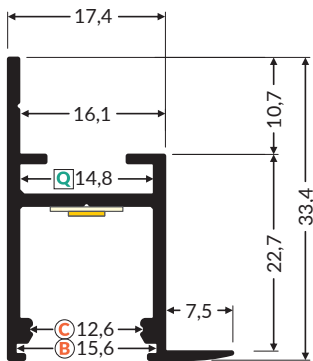

Technical manual  
Instrukcja techniczna  
Technische Anleitung  
Manuel technique

**Q<sup>1</sup>** → 202

connector Q 90 deg bent  
łącznik Q 90 st gięty  
Verbinder Q 90 Grad gebogen  
connecteur Q 90 degrés plié

**Q<sup>2</sup>** → 202

connector Q 180 deg  
łącznik Q 180 st  
Verbinder Q 180 Grad  
connecteur Q 80 degrés

**Q<sup>3</sup>** → 202

connector Q 135 deg  
łącznik Q 135 st  
Verbinder Q 135 Grad  
connecteur Q 135 degrés

**Q<sup>4</sup>** → 202

connector Q 90 deg  
łącznik Q 90 st  
Verbinder Q 90 Grad  
connecteur Q 90 degrés

**B** → 194

diffuser B slide  
klosz B wsuwany  
Abdeckung B einschiebbar  
diffuseur B coulissant

**C** → 195

diffuser C click  
klosz C klik  
Abdeckung C einclippsbar  
diffuseur C clic

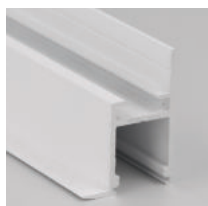

white painted  
biały malowany  
weiß lackiert  
peint en blanc



anodized  
anodowany  
eloxiert  
surface anodisée



raw aluminium  
surowe aluminium  
Rohaluminium  
aluminium brut

1000 mm	<b>C3010001</b>	<b>C3010020</b>	<b>C3010000</b>
2000 mm	<b>C3020001</b>	<b>C3020020</b>	<b>C3020000</b>
3000 mm	<b>C3030001</b>	<b>C3030020</b>	<b>C3030000</b>
4050 mm	<b>C3040001</b>	<b>C3040020</b>	<b>C3040000</b>



# SMOOTH12 BC/Q9

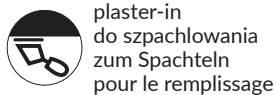

- installation to the wall without a drywall system
- invisible profile, atmospheric light
- accentuating of the room outline

- montaż do zastanej ściany, bez konieczności tworzenia suchej zabudowy
- niewidoczny profil, nastrojowe światło
- akcentowanie obrysów pomieszczenia

- Installation an einer bestehenden Wand ohne Trockenbauarbeiten
- unsichtbares Profil, stimmungsvolles Licht
- Hervorhebung der Raumkontur

- installation sur un mur existant, sans avoir besoin de créer des cloisons sèches
- profilé invisible, lumière ambiante
- accentuant les contours de la pièce



more information



więcej szczegółów



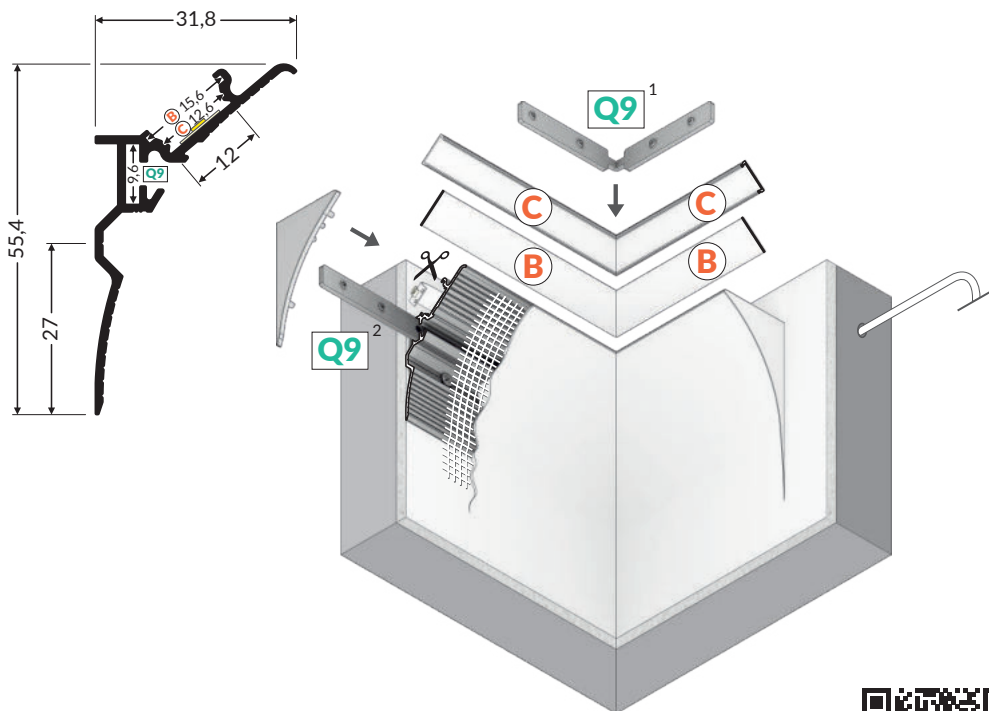

Technical manual  
Instrukcja techniczna  
Technische Anleitung  
Manuel technique



raw aluminium  
surowe aluminium  
Rohaluminium  
aluminium brut

1000 mm	H9000100
2000 mm	H9000200
3000 mm	H9000300
4050 mm	H9000400

end cap SMOOTH12  
zaślepka SMOOTH12  
Endkappe SMOOTH12  
embout SMOOTH12

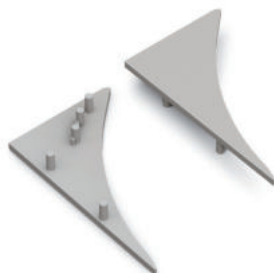

grey  
szary  
grau  
gris  
H9999922



**Q9**<sup>1</sup> → 203

connector Q9 90 deg bent  
łącznik Q9 90 st gięty  
Verbinder Q9 90 Grad gebogen  
connecteur Q9 90 degrés plié

**Q9**<sup>2</sup> → 203

connector Q9 180 deg  
łącznik Q9 180 st  
Verbinder Q9 180 Grad  
connecteur Q9 180 degrés

**Q9**<sup>3</sup> → 203

connector Q9 135 deg  
łącznik Q9 135 st  
Verbinder Q9 135 Grad  
connecteur Q9 135 degrés

**Q9**<sup>4</sup> → 203

connector Q9 120 deg  
łącznik Q9 120 st  
Verbinder Q9 120 Grad  
connecteur Q9 120 degrés

**Q9**<sup>5</sup> → 203

connector Q9 90 deg  
łącznik Q9 90 st  
Verbinder Q9 90 Grad  
connecteur Q9 90 degrés

**Q9**<sup>6</sup> → 203

connector Q9 60 deg  
łącznik Q9 60 st  
Verbinder Q9 60 Grad  
connecteur Q9 60 degrés

**Q9**<sup>7</sup> → 203

connector Q9 45 deg  
łącznik Q9 45 st  
Verbinder Q9 45 Grad  
connecteur Q9 45 degrés

**B** → 194

diffuser B slide  
klosz B wsuwany  
Abdeckung B einschiebbar  
diffuseur B coulissant

**C** → 195

diffuser C click  
klosz C klik  
Abdeckung C einclippsbar  
diffuseur C clic



# HIDE10 C4

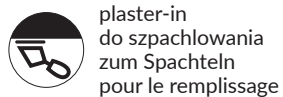

- profile that fits into the thickness of a standard plasterboard (12,5 mm)  
- continuous line of light when using LED strip 120 P/m

- profil mieszczący się w grubości standardowej płyty kartonowo-gipsowej (12,5 mm)  
- ciągła linia światła przy użyciu taśmy 120 P/m

- Profil, das in die Dicke einer Standard-Rigipsplatte passt (12,5 mm)  
- homogene Lichtlinie unter Verwendung vom 120 P/m Band

- le profil correspond à l'épaisseur d'une cloison sèche standard (12,5 mm)  
- ligne continue de lumière utilisant un ruban LED 120 P/M.



more  
information



więcej  
szczegółów



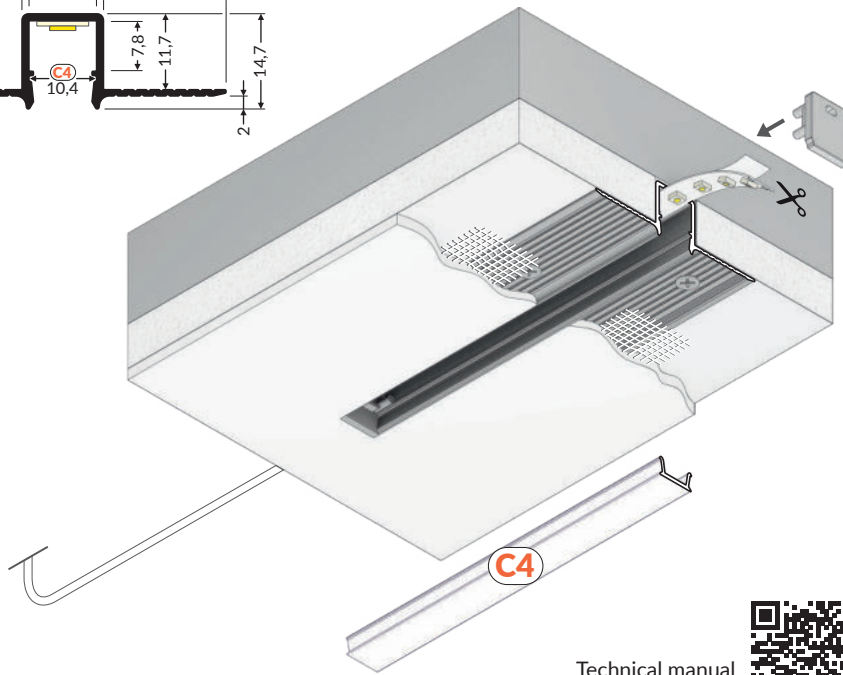
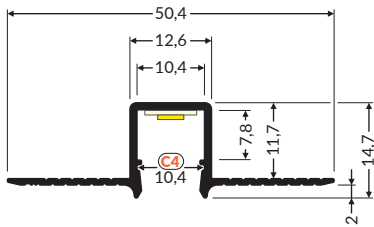

Technical manual  
Instrukcja techniczna  
Technische Anleitung  
Manuel technique



**C4** → 196

diffuser C4 click  
klosz C4 klik  
Abdeckung C4 einclipsbar  
diffuseur C4 clic

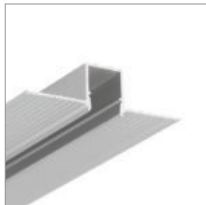

anodized  
anodowany  
eloxiert  
surface anodisée

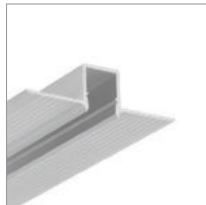

raw aluminium  
surowe aluminium  
Rohaluminium  
aluminium brut

1000 mm	<b>H7000120</b>	<b>H7000100</b>
2000 mm	<b>H7000220</b>	<b>H7000200</b>
3000 mm	<b>H7000320</b>	<b>H7000300</b>
4050 mm	<b>H7000420</b>	<b>H7000400</b>

end cap HIDE10 with hole  
zaślepka HIDE10 z otworem  
Endkappe HIDE10 mit Öffnung  
embout HIDE10 avec un trou

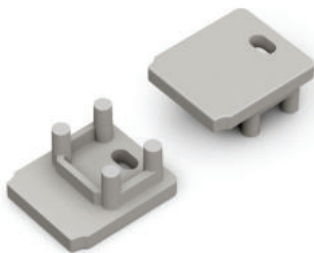

grey  
szary  
grau  
gris  
**H7999922**



# LINEA-IN20 TRIMLESS EE7F

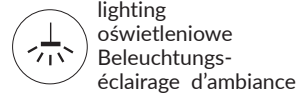
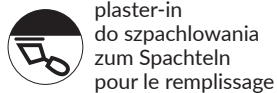

- for spackle flange mounting  
- Slick socket - easy assembly technology  
- continuous line of light (when using LED strip 120 P/m and opal diffuser)

- do zabudowy szpachlowej  
- gniazdo Slick - prosty montaż klosza  
- ciągła linia światła (przy użyciu taśmy 120 P/m oraz klosza mlecznego)

- für Spachteltechnik  
- Slick Sockel - einfache Montage der Abdeckung  
- eine homogene Lichtlinie (beim Gebrauch eines LED Streifens mit 120 P/m und einer opalen Abdeckung)

- pour le plâtrage  
- Prise avec fonction Slick - installation simple de diffuseur  
- une ligne continue de lumière (à l'aide de strip 120 P/m et de diffuseur opaque)



more information



więcej szczegółów





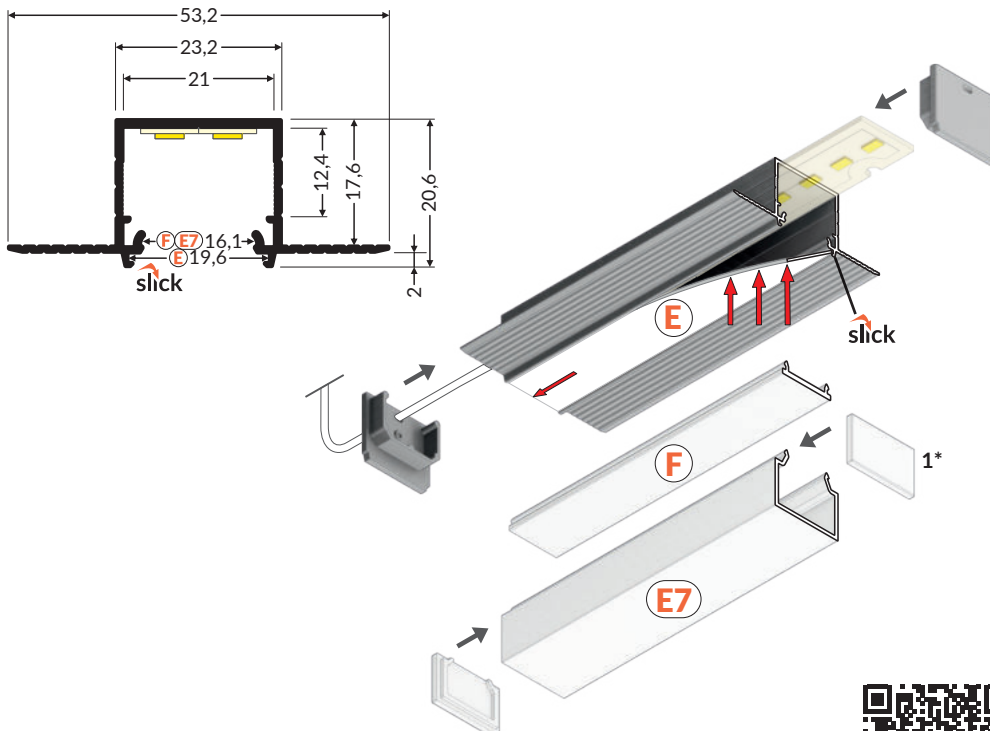

**E** → 198

diffuser E slide  
klosz E wsuwany  
Abdeckung E einschiebbar  
diffuseur E coulissant

**F** → 199

diffuser F click  
klosz F klik  
Abdeckung F einclipsbar  
diffuseur F clic

**E7** → 198

diffuser E7 click  
klosz E7 klik  
Abdeckung E7 einclipsbar  
diffuseur E7 clic

**1\*** → 198

end cap E7  
zaślepka E7  
Endkappe E7  
embout E7

Technical manual  
Instrukcja techniczna  
Technische Anleitung  
Manuel technique



white painted  
biały malowany  
weiß lackiert  
peint en blanc

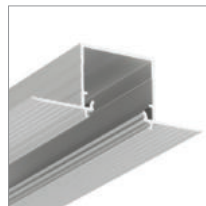

anodized  
anodowany  
eloxiert  
surface anodisée



raw aluminium  
surowe aluminium  
Rohaluminium  
aluminium brut

1000 mm	<b>G1000101</b>	<b>G1000120</b>	<b>G1000100</b>
2000 mm	<b>G1000201</b>	<b>G1000220</b>	<b>G1000200</b>
3000 mm	<b>G1000301</b>	<b>G1000320</b>	<b>G1000300</b>
4050 mm	<b>G1000401</b>	<b>G1000420</b>	<b>G1000400</b>

end cap LINEA-IN20 TRIMLESS with hole  
zaślepka LINEA-IN20 TRIMLESS z otworem  
Endkappe LINEA-IN20 TRIMLESS mit Öffnung  
embout LINEA-IN20 TRIMLESS avec un trou



white            silver  
biały            srebrny  
weiß            silbern  
blanc            argent  
**G1000501**    **G1000540**

grey  
szary  
grau  
gris  
**G1000522**



# VARIO30-04, 05 ACDE-9



max 30 mm



plaster-in  
do szpachlowania  
zum Spachteln  
pour le remplissage



architectural  
architektoniczne  
architektonisch  
architecture



lighting  
oświetleniowe  
Beleuchtungs-  
éclairage d'ambiance

- part of a larger system for luminaire construction
- continuous line of light in angled connections
- unlimited possibilities for light creation

- system do tworzenia różnorodnych kombinacji
- ciągła linia światła w połączeniach kątowych
- nieograniczone możliwości kreowania światła

- System für die Bildung verschiedener Kombinationen
- homogene Lichtlinie in Eckverbindungen
- unbegrenzte Möglichkeiten der Lichtgestaltung

- un élément d'un très vaste système pour la construction de luminaires
- une ligne lumineuse permanente dans les connecteurs angulaires
- des possibilités illimitées concernant la création de lumière

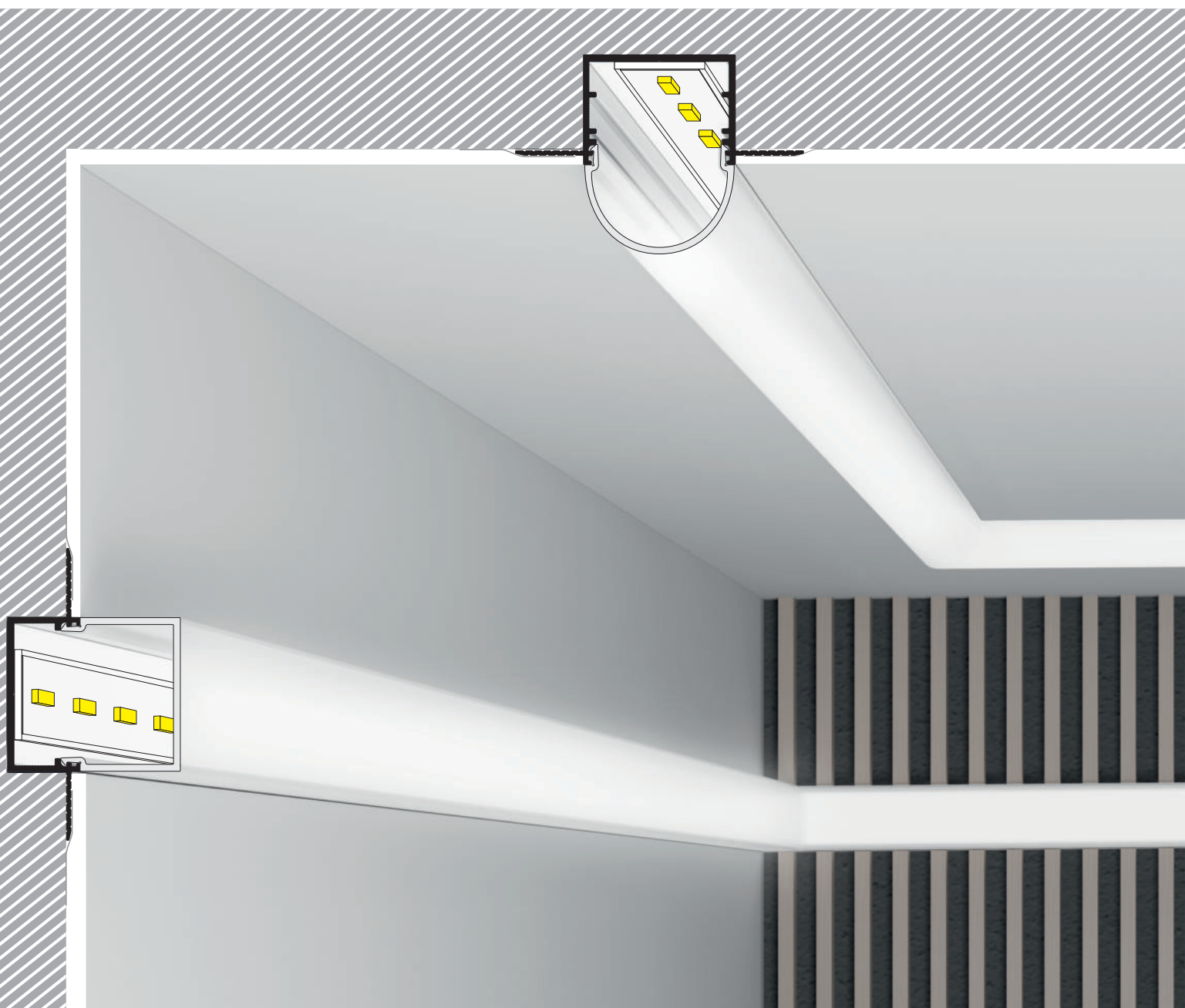

**VARIO30-04**  
**ACDE-9**

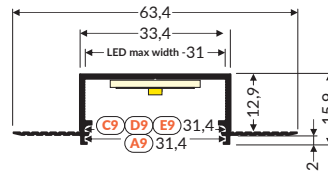
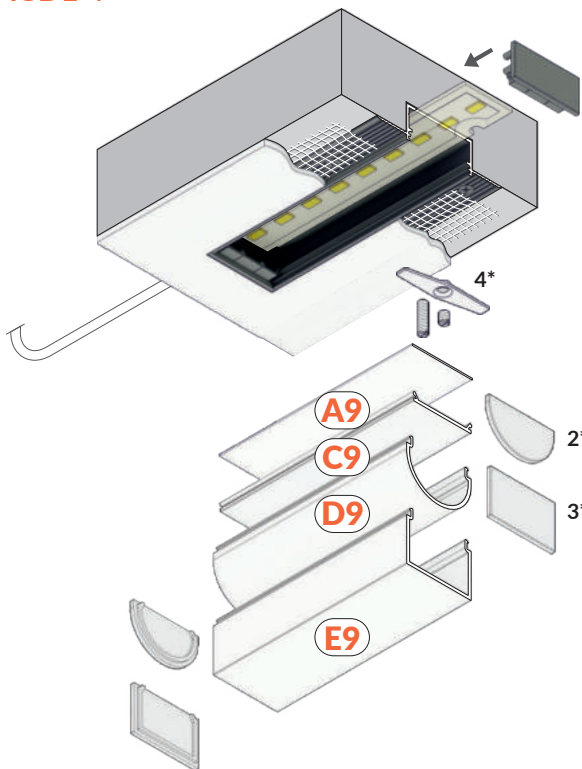

**A9** → 194

diffuser A9 slide  
klosz A9 wsuwany  
Abdeckung A9 einschiebbar  
diffuseur A9 coulissant

**C9** → 197

diffuser C9 click  
klosz C9 klik  
Abdeckung C9 einclipsbar  
diffuseur C9 clic

**D9** → 198

diffuser D9 click  
klosz D9 klik  
Abdeckung D9 einclipsbar  
diffuseur D9 clic

**E9** → 199

diffuser E9 click  
klosz E9 klik  
Abdeckung E9 einclipsbar  
diffuseur E9 clic



more  
information



więcej  
szczegółów



Technical manual  
Instrukcja techniczna  
Technische Anleitung  
Manuel technique

**2\*** → 198

end cap D9  
zaślepka D9  
Endkappe D9  
embout D9

**3\*** → 199

end cap E9  
zaślepka E9  
Endkappe E9  
embout E9

**4\*** → 210

LED clamp VARIO30  
docisk LED VARIO30  
LED Klemme VARIO30  
clip de fixation LED VARIO30

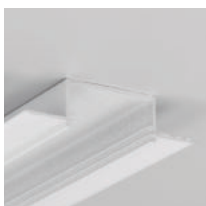

white painted  
biały malowany  
weiß lackiert  
peint en blanc

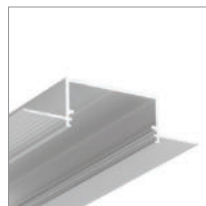

anodized  
anodowany  
eloxiert  
surface anodisée



raw aluminium  
surowe aluminium  
Rohaluminium  
aluminium brut

1000 mm	<b>V3130001</b>	<b>V3130020</b>	<b>V3130000</b>
2000 mm	<b>V3140001</b>	<b>V3140020</b>	<b>V3140000</b>
3000 mm	<b>V3150001</b>	<b>V3150020</b>	<b>V3150000</b>
4050 mm	<b>V3160001</b>	<b>V3160020</b>	<b>V3160000</b>

end cap VARIO30-04  
zaślepka VARIO30-04  
Endkappe VARIO30-04  
embout VARIO30-04



white  
biały  
weiß  
blanc  
**V4900001**

silver  
srebrny  
silbern  
argent  
**V4900040**

grey  
szary  
grau  
gris  
**V4900022**





**VARIO30-05**  
**ACDE-9**

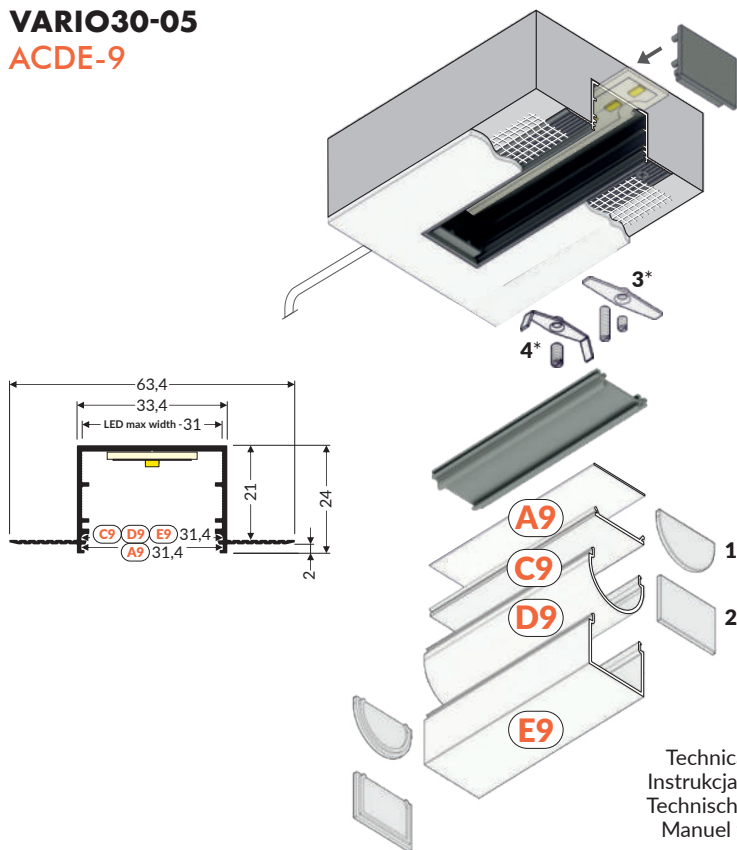

Technical manual  
Instrukcja techniczna  
Technische Anleitung  
Manuel technique

**A9** → 194

diffuser A9 slide  
klosz A9 wsuwany  
Abdeckung A9 einziehbar  
diffuseur A9 coulissant

**C9** → 197

diffuser C9 click  
klosz C9 klik  
Abdeckung C9 einclipsbar  
diffuseur C9 clic

**D9** → 198

diffuser D9 click  
klosz D9 klik  
Abdeckung D9 einclipsbar  
diffuseur D9 clic

**E9** → 199

diffuser E9 click  
klosz E9 klik  
Abdeckung E9 einclipsbar  
diffuseur E9 clic

**1\*** → 198

end cap D9  
zaślepka D9  
Endkappe D9  
embout D9

**2\*** → 199

end cap E9  
zaślepka E9  
Endkappe E9  
embout E9

**3\*** → 210

LED clamp VARIO30  
docisk LED VARIO30  
LED Klemme VARIO30  
clip de fixation LED VARIO30

**4\*** → 210

LED clamp VARIO30-1  
docisk LED VARIO30-1  
LED Klemme VARIO30-1  
clip de fixation LED VARIO30-1



more  
information



więcej  
szczegółów



	white painted biały malowany weiß lackiert peint en blanc	anodized anodowany eloxiert surface anodisée	raw aluminium surowe aluminium Rohaluminium aluminium brut
1000 mm	V3170001	V3170020	V3170000
2000 mm	V3180001	V3180020	V3180000
3000 mm	V3190001	V3190020	V3190000
4050 mm	V3200001	V3200020	V3200000

end cap VARIO30-05  
zaślepka VARIO30-05  
Endkappe VARIO30-05  
embout VARIO30-05

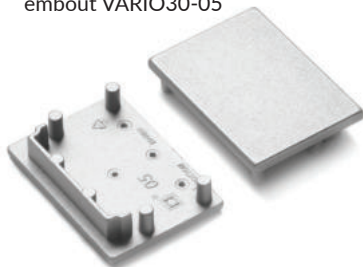

white biały weiß blanc	silver srebrny silbern argent
V4910001	V4910040

grey  
szary  
grau  
gris  
V4910022

# CONNECTORS ŁĄCZNIKI VERBINDER CONNECTEURS

material: aluminium, polycarbonate  
 materiał: aluminium, poliwęglan  
 Material: Aluminium, Polycarbonat  
 matériel: aluminium, polycarbonate

connector VARIO30-05 60 deg  
 łącznik VARIO30-05 60 st  
 Verbinder VARIO30-05 60 Grad  
 connecteur VARIO30-05 60 degrés

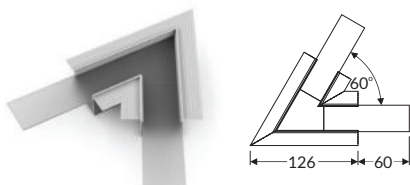

white painted  
 biały malowany  
 weiß lackiert  
 peint en blanc  
**V4720001S**

anodized  
 anodowany  
 eloxiert  
 surface anodisée  
**V4720020S**

connector VARIO30-05 90 deg  
 łącznik VARIO30-05 90 st  
 Verbinder VARIO30-05 90 Grad  
 connecteur VARIO30-05 90 degrés

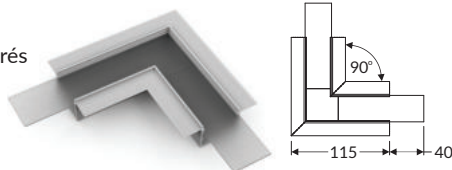

white painted  
 biały malowany  
 weiß lackiert  
 peint en blanc  
**V4730001S**

anodized  
 anodowany  
 eloxiert  
 surface anodisée  
**V4730020S**

connector VARIO30-05 90 deg bent  
 łącznik VARIO30-05 90 st gięty  
 Verbinder VARIO30-05 90 Grad gebogen  
 connecteur VARIO30-05 90 degrés plié

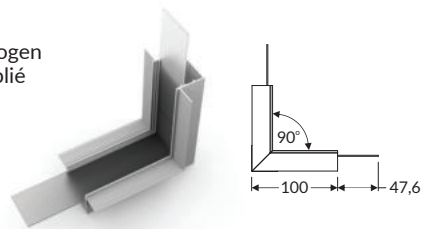

white painted  
 biały malowany  
 weiß lackiert  
 peint en blanc  
**V4740001S**

anodized  
 anodowany  
 eloxiert  
 surface anodisée  
**V4740020S**

connector VARIO30-05 120 deg  
 łącznik VARIO30-05 120 st  
 Verbinder VARIO30-05 120 Grad  
 connecteur VARIO30-05 120 degrés

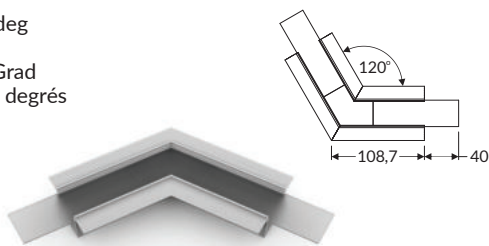

white painted  
 biały malowany  
 weiß lackiert  
 peint en blanc  
**V4750001S**

anodized  
 anodowany  
 eloxiert  
 surface anodisée  
**V4750020S**

connector VARIO30-05 135 deg  
 łącznik VARIO30-05 135 st  
 Verbinder VARIO30-05 135 Grad  
 connecteur VARIO30-05 135 degrés

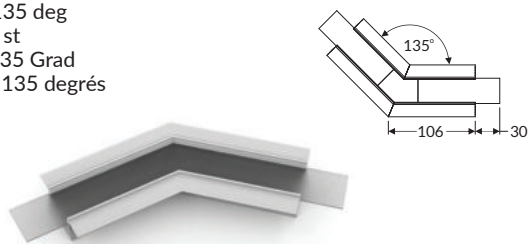

white painted  
 biały malowany  
 weiß lackiert  
 peint en blanc  
**V4760001S**

anodized  
 anodowany  
 eloxiert  
 surface anodisée  
**V4760020S**

connector VARIO30-05 180 deg  
 łącznik VARIO30-05 180 st  
 Verbinder VARIO30-05 180 Grad  
 connecteur VARIO30-05 180 degrés



**V4610000S**

connector VARIO30-05 270 deg bent  
 łącznik VARIO30-05 270 st gięty  
 Verbinder VARIO30-05 270 Grad gebogen  
 connecteur VARIO30-05 270 degrés plié

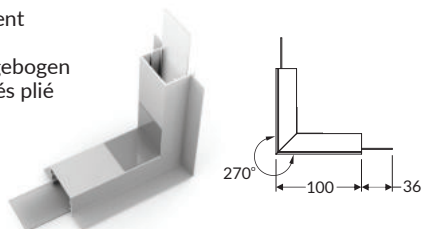

white painted  
 biały malowany  
 weiß lackiert  
 peint en blanc  
**V4770001S**

anodized  
 anodowany  
 eloxiert  
 surface anodisée  
**V4770020S**





**TILE-IN  
DO PŁYTEK  
FÜR FLIESEN  
POUR LES CARREAUX**

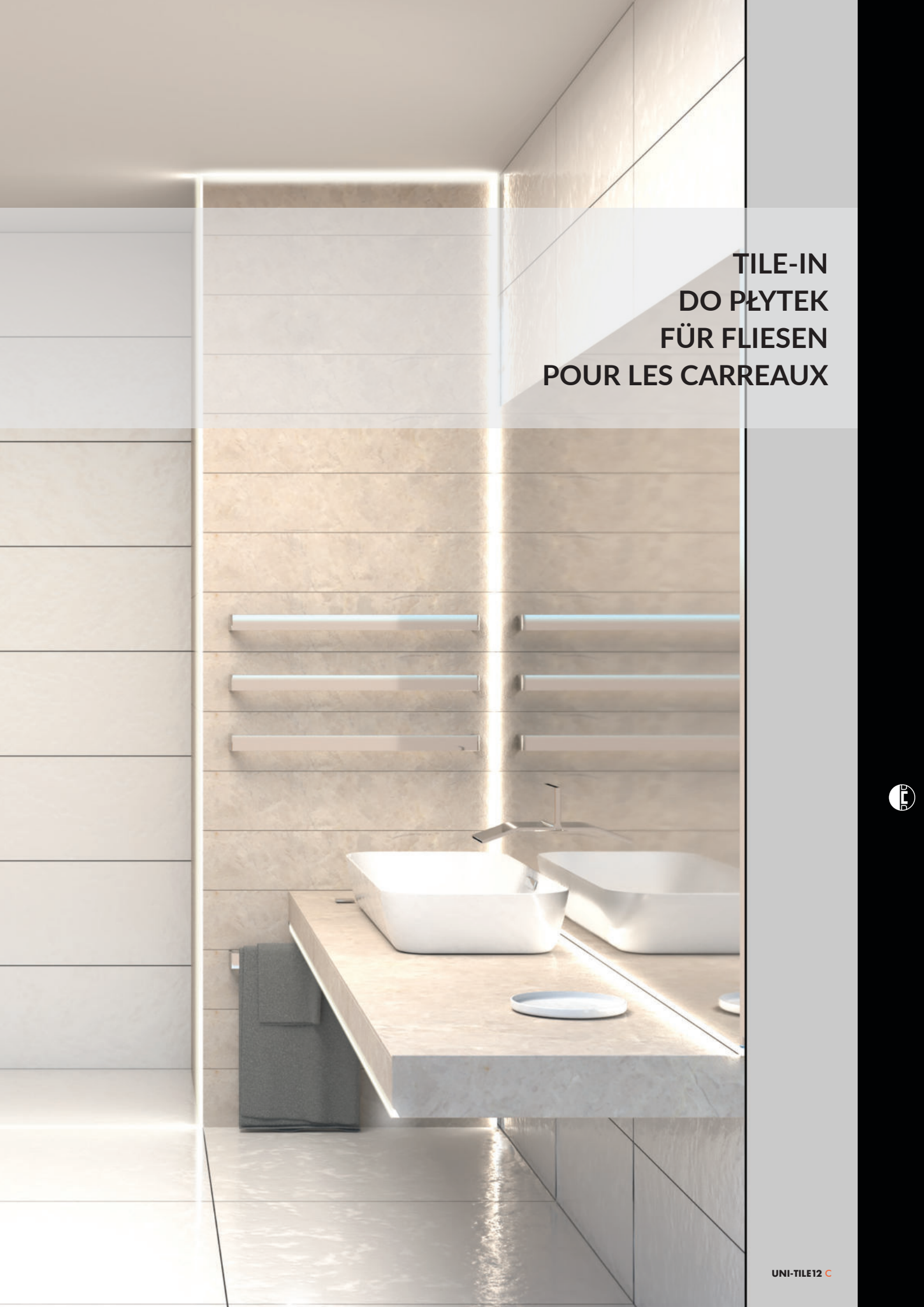

# FLOOR8 K



max 8 mm



tile-in  
do płytek  
für Fliesen  
pour les carreaux



architectural  
architektoniczne  
architektonisch  
pour le batiment



240  
P/m

for continuous line of light  
dla ciągłej linii światła  
für homogenes Licht  
pour une ligne de lumière continue

- recessed floor profile
- high abrasion resistance, resistant diffuser
- possibility of waterproof
- with high humidity, please use waterproof tape outline
- optimal height for installation in standard tiles or floor panels

- profil wpustowy do podłóg
- wysoka odporność na ścieranie, wytrzymały klosz
- możliwość uzyskania wodoszczelności
- przy podwyższonej wilgotności stosować taśmę wodoodporną
- optymalna wysokość do montażu w standardowych płytkach lub panelach podłogowych

- Einbauprofile für Böden
- eine hohe Beständigkeit gegen Abwischbarkeit, eine widerstandsfähige Abdeckung
- Möglichkeit des Erreichens von Wasserbeständigkeit
- bei einer erhöhten Feuchtigkeit soll man einen wasserdichten LED Streifen verwenden
- optimale Höhe für den Einbau in Standardfliesen oder Fussbodenpanelen

- profilés à encastrer pour les sols
- haute résistance à l'abrasion, diffuseur durable
- la possibilité d'obtenir une étanchéité
- en cas d'humidité accrue, utilisez un ruban LED étanche
- hauteur optimale pour l'installation dans des carreaux ou des panneaux de sol standard



more  
information



więcej  
szczegółów



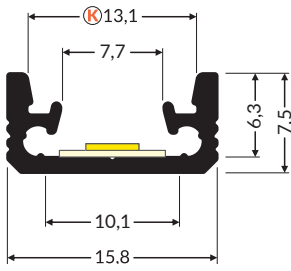

In high humidity conditions  
use waterproof LED strip and silicone seal  
Przy podwyższonej wilgotności  
zaleca się użycie zestawu uszczelniającego  
i wodoodpornej taśmy  
Bei hoher Feuchtigkeit wasserdichtes Band  
und Silikondichtung verwenden  
Dans des conditions d'humidité élevée  
il faut utiliser un ruban LED étanche et un joint  
en silicone

**K** → 200

diffuser K click  
klosz K klik  
Abdeckung K einclipsbar  
diffuseur K clic

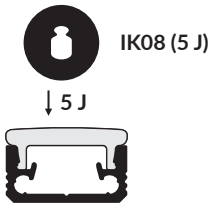

Technical manual  
Instrukcja techniczna  
Technische Anleitung  
Manuel technique



anodized  
anodowany  
eloxiert  
surface anodisée

1000 mm	G6000120
2000 mm	G6000220
3000 mm	G6000320
4050 mm	G6000420

end cap FLOOR8  
zaślepka FLOOR8  
Endkappe FLOOR8  
embout FLOOR8



sealings for FLOOR8 end caps  
2x silicone sealings,  
4x rubber o-ring  
uszczelki do zaślepki FLOOR8  
2x silikonowa uszczelka  
4x gumowa uszczelka o-ring  
Dichtungen für Endkappe  
2x Silikon-Dichtungen  
4x Gummi O-Ring  
joints pour le embout  
2x joint en silicone  
4x joint torique en caoutchouc

silver  
srebrny  
silbern  
argent  
G6999940

grey  
szary  
grau  
gris  
G6999922



G69998005





# FLOOR12 K/U



max 12 mm



tile-in  
do płytek  
für Fliesen  
pour les carreaux



architectural  
architektoniczne  
architektonische  
pour le bâtiment



for continuous line of light  
dla ciągłej linii światła  
für homogenes Licht  
pour une ligne de lumière continue

- recessed floor profile
- high abrasion resistance, resistant diffuser
- possibility of waterproof
- with high humidity, please use waterproof tape outline
- the perfect solution for application in thicker floor materials

- profil wpustowy do podłóg
- wysoka odporność na ścieranie, wytrzymały klosz
- możliwość uzyskania wodoszczelności
- przy podwyższonej wilgotności stosować taśmę wodoodporną
- rozwiązanie idealne do stosowania w grubszych materiałach podłogowych

- Einbauprofil für Böden
- eine hohe Beständigkeit gegen Abwischbarkeit, eine widerstandsfähige Abdeckung
- Möglichkeit des Erreichens von Wasserbeständigkeit
- bei einer erhöhten Feuchtigkeit soll man einen wasserdichten LED Streifen verwenden
- Die ideale Lösung zur Verwendung in dickeren Fussbodenmaterialien

- profilés à encastrer pour les sols
- haute résistance à l'abrasion, diffuseur durable
- la possibilité d'obtenir une étanchéité
- en cas d'humidité accrue, utilisez un ruban LED étanche
- idéal pour une utilisation dans des matériaux de revêtement de sol plus épais



more  
information



więcej  
szczegółów



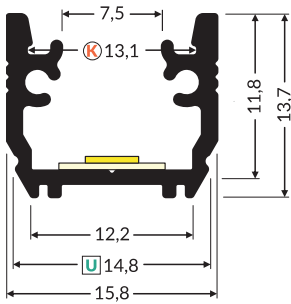

In high humidity conditions  
use waterproof LED strip and silicone seal  
Przy podwyższonej wilgotności  
zaleca się użycie zestawu uszczelniającego  
i wodoodpornej taśmy  
Bei hoher Feuchtigkeit wasserdichtes Band  
und Silikondichtung verwenden  
Dans des conditions d'humidité élevée  
il faut utiliser un ruban LED étanche et un joint  
en silicone

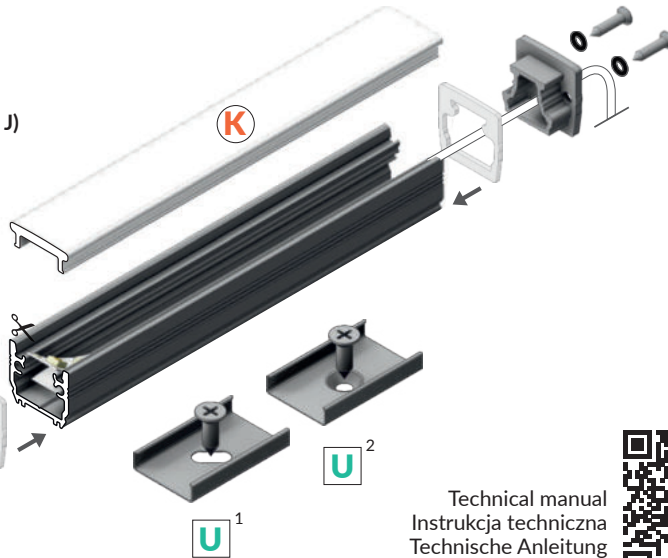
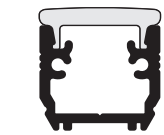

Technical manual  
Instrukcja techniczna  
Technische Anleitung  
Manuel technique



**K** → 200

diffuser K click  
klosz K klik  
Abdeckung K einclipsbar  
diffuseur K clic

**U**<sup>1</sup> → 204

mounting plate U  
uchwyt U  
Halter U  
fixation U

**U**<sup>2</sup> → 204

mounting plate U cone  
uchwyt U cone  
Halter U cone  
fixation U cône



anodized  
anodowany  
eloxiert  
surface anodisée

1000 mm	<b>B1010020</b>
2000 mm	<b>B1020020</b>
3000 mm	<b>B1080020</b>
4050 mm	<b>B1090020</b>



end cap FLOOR12  
zaślepka FLOOR12  
Endkappe FLOOR12  
embout FLOOR12



silver  
srebrny  
silbern  
argent  
**B1940040**

grey  
szary  
grau  
gris  
**B1940022**

end cap FLOOR12 with hole  
zaślepka FLOOR12 z otworem  
Endkappe FLOOR12 mit Öffnung  
embout FLOOR12 avec un trou



silver  
srebrny  
silbern  
argent  
**B1960040**

grey  
szary  
grau  
gris  
**B1960022**

sealings for FLOOR12 end caps  
2x silicone sealings,  
4x rubber o-ring  
uszczelki do zaślepki FLOOR12  
2x silikonowa uszczelka  
4x gumowa uszczelka o-ring  
Dichtungen für Endkappe FLOOR12  
2x Silikon-Dichtungen  
4x Gummi O-Ring  
joints pour le embout FLOOR12  
2x joint en silicone  
4x joint torique en caoutchouc



**B1830000**



max 10 mm



tile-in  
do płytek  
für Fliesen  
pour les carreaux



architectural  
architektoniczne  
architektonische  
pour le bâtiment

- for the illumination of steps and their edges
- mounting in tiles
- elegant and compact (one-piece)
- without any glare effect
- versatile – for places with different levels of movement
- socket with Slick function

- do oświetlania stopni i wykończenia ich krawędzi
- montaż w płytkach
- elegancki i kompaktowy (jednoelementowy)
- bez efektu olśnienia
- uniwersalny – do miejsc o różnym natężeniu ruchu
- gniazdo z funkcją Slick

- zur Beleuchtung von Stufen und Treppenkanten
- Montage in den Fliesen
- elegant und kompakt (Einzelement)
- ohne Blendeffekt
- universell – für Stellen mit verschiedener Verkehrsdichte
- Steckplatz mit Slick-Funktion

- pour éclairer les marches et finir leurs bords
- installation dans le carrelage
- élégant et compact en 1 pièce
- sans effet d'éblouissement
- universel – pour les endroits avec intensité de circulation diverse
- prise avec fonction Slick



more  
information



więcej  
szczegółów

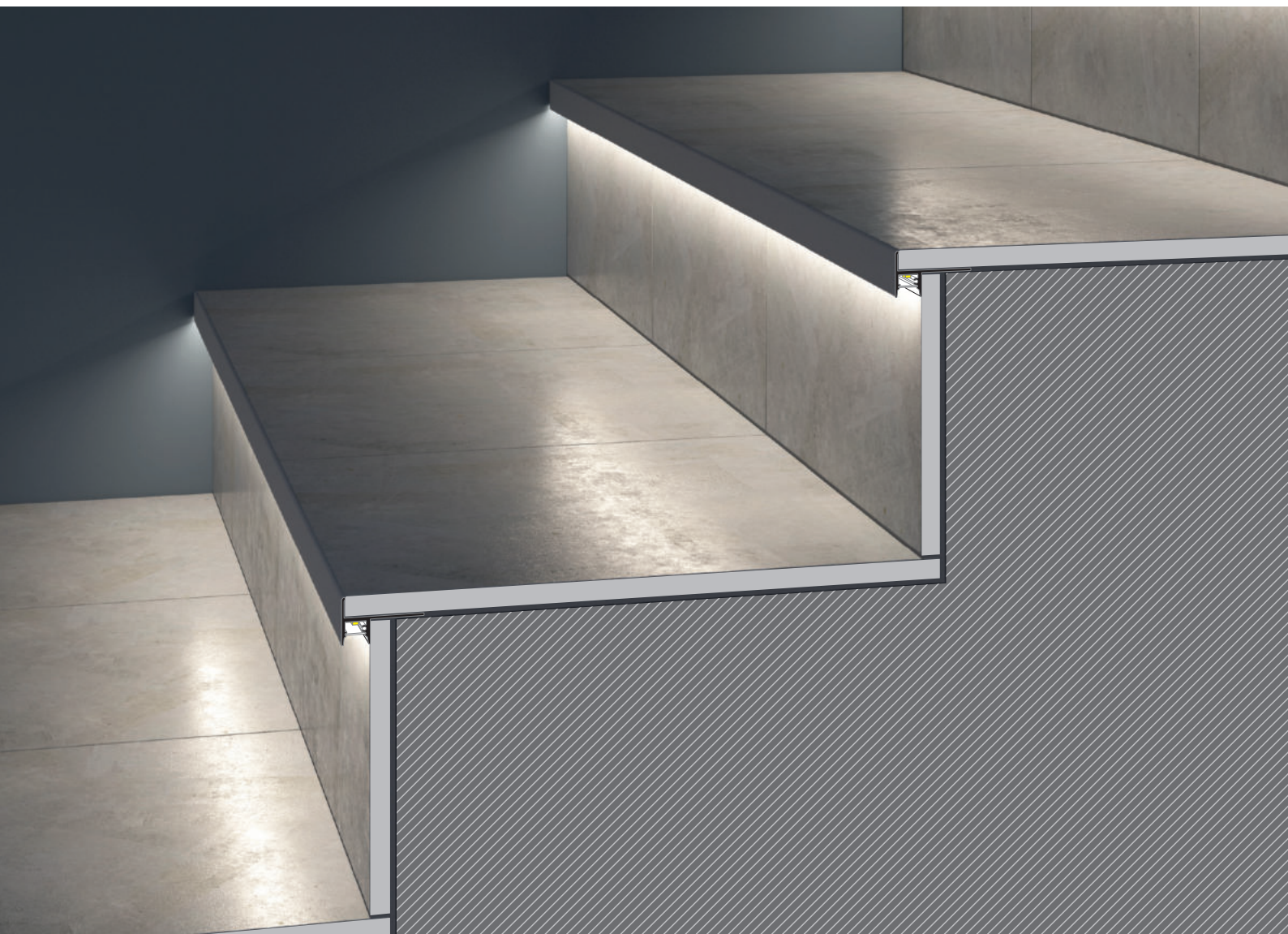



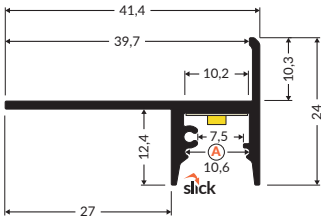

**A** → 194

diffuser A slide  
klosz A wsuwany  
Abdeckung A einschiebbar  
diffuseur A coulissant

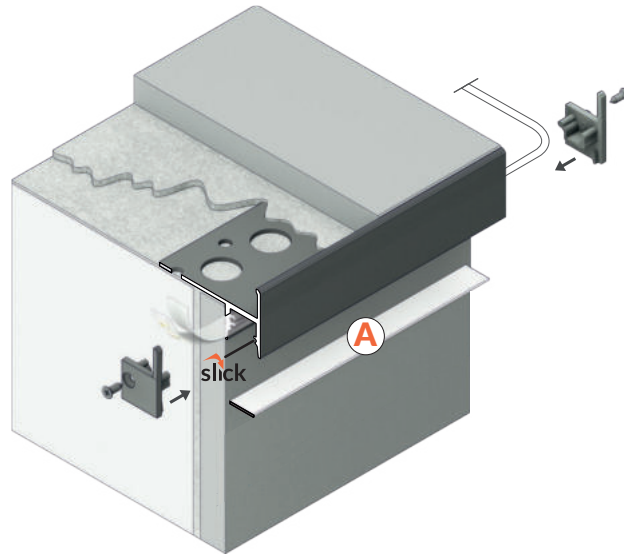

anodized  
anodowany  
eloxiert  
surface anodisée

1000 mm	<b>J8000120</b>
2000 mm	<b>J8000220</b>
3000 mm	<b>J8000320</b>
4050 mm	<b>J8000420</b>

end cap UP-TILE10  
zaślepka UP-TILE10  
Endkappe UP-TILE10  
embout UP-TILE10



silver  
srebrny  
silbern  
argent  
**J8999940**

grey  
szary  
grau  
gris  
**J8999922**

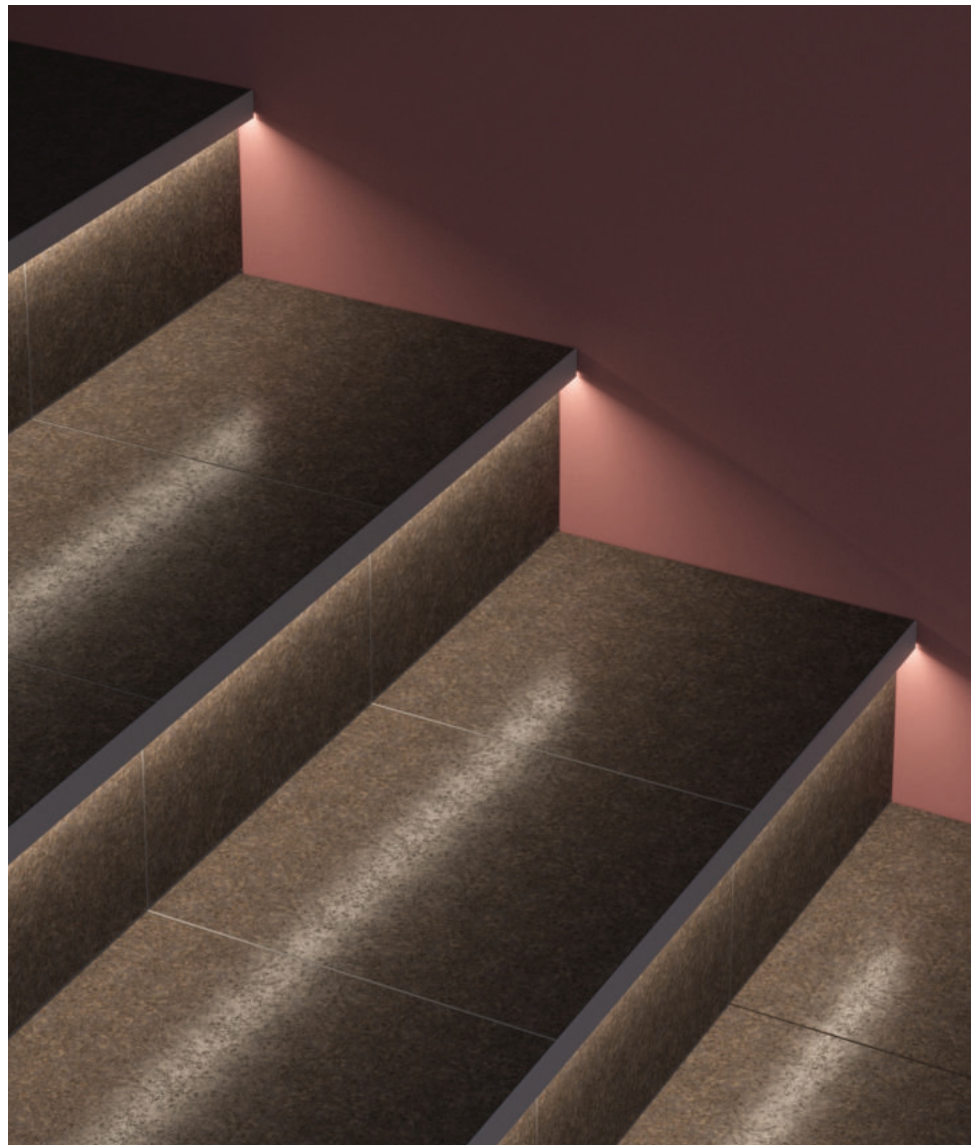

# UNI-TILE12 C



max 12 mm



tile-in  
do płytek  
für Fliesen  
pour les carreaux



architectural  
architektoniczne  
architektonische  
pour le bâtiment

- family of profiles for under-tile mounting
- three mounting angles available: 90, 180, 270 degrees
- for 10 mm tiles
- perforated mounting holes

- rodzina profili do montażu podpłytkowego
- dostępne trzy kąty montażu: 90 / 180 / 270 st
- do płytek o grubości do 10 mm
- gotowe otworowanie montażowe

- eine Familie der Profile zur Unterfliesenmontage
- drei Montagewinkel zugänglich: 90 / 180 / 270 Grad
- für Fliesen bis 10 mm Dicke
- fertiges Montageloch

- une famille de profilés de montage dans le carrelage
- trois angles de montage disponibles : 90 / 180 / 270 degrés
- pour carreaux jusqu'à 10 mm d'épaisseur
- version disponible avec trous de montage prêts à l'emploi



# UNI-TILE12 90 deg / st / grad / degrés C plus

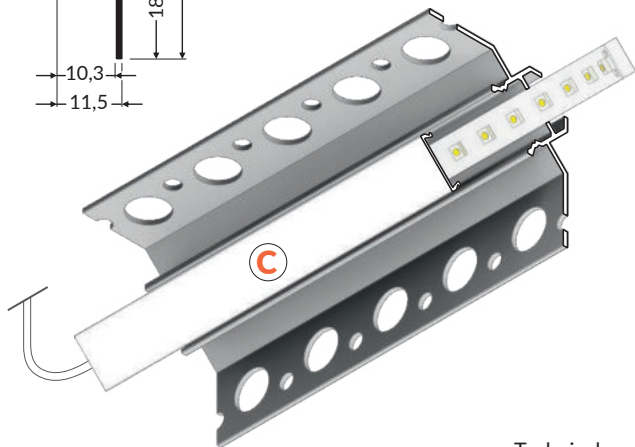
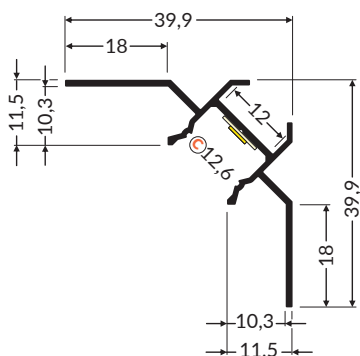

Technical manual  
Instrukcja techniczna  
Technische Anleitung  
Manuel technique



more information



więcej szczegółów



**C** → 195

diffuser C click  
klosz C klik  
Abdeckung C einclipsbar  
diffuseur C clic



anodized  
anodowany  
eloxiert  
surface anodisée

1000 mm	G4000520
2000 mm	G4000620
3000 mm	G4000820
4050 mm	G4000920

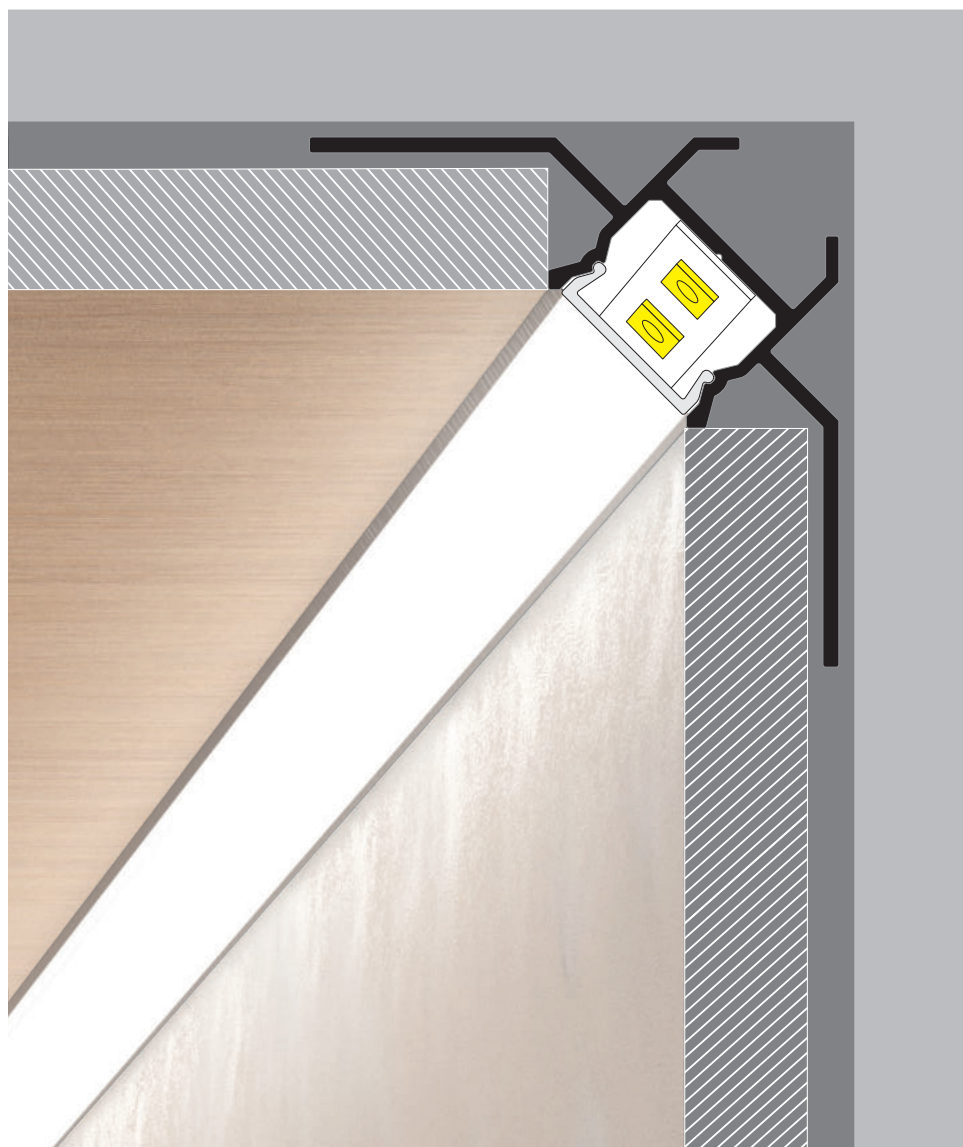



# UNI-TILE12 180 deg / st / grad / degrés C plus

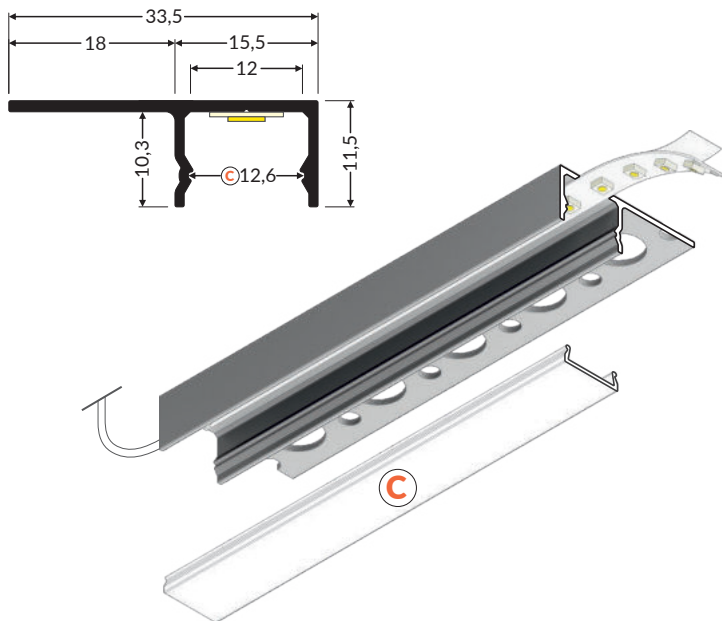

**C** → 195

diffuser C click  
klosz C klik  
Abdeckung C einclipsbar  
diffuseur C clic



more  
information



więcej  
szczegółów



Technical manual  
Instrukcja techniczna  
Technische Anleitung  
Manuel technique

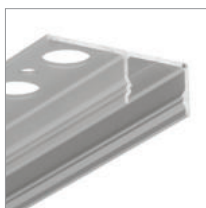

anodized  
anodowany  
eloxiert  
surface anodisée

1000 mm	G2000520
2000 mm	G2000620
3000 mm	G2000820
4050 mm	G2000920

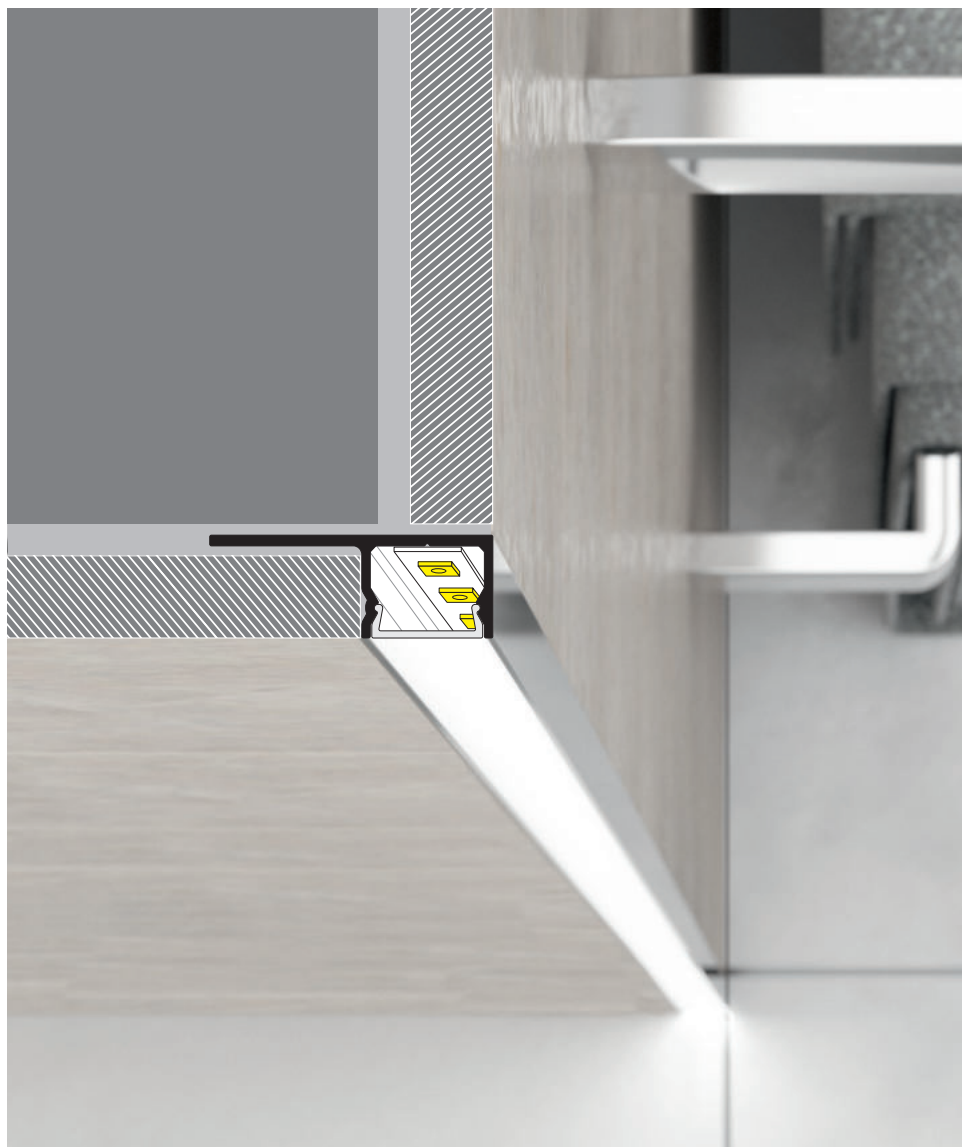

# UNI-TILE12 270 deg / st / grad / degrés C plus

**C** → 195

diffuser C click  
klosz C klik  
Abdeckung C einclipsbar  
diffuseur C clic

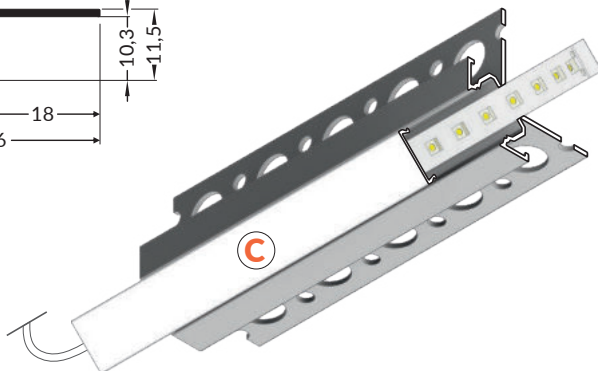
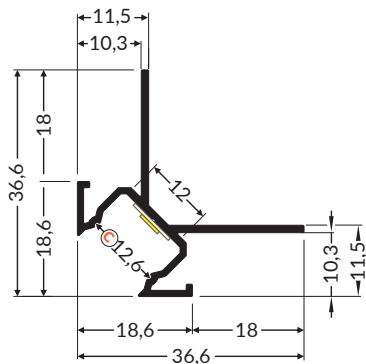

more information



więcej szczegółów



Technical manual  
Instrukcja techniczna  
Technische Anleitung  
Manuel technique



anodized  
anodowany  
eloxiert  
surface anodisée

1000 mm	G3000520
2000 mm	G3000620
3000 mm	G3000820
4050 mm	G3000920





# VED VANDET

AT THE WATER'S EDGE

AM WASSER

OM SOMMEREN LEVER VI PÅ STRANDEN.  
HER ER LIVET DET SAMME  
SOM ALTID.

HER FISKER VI OG JAGER KYSTENS FUGLE.  
MEN HAVET ER EN LUNEFULD NABO.  
VI MÅ OFRE TIL GUDERNE,  
SÅ DE FORMILDES  
OG FYLDER VORES RUSER MED FISK.

WE LIVE ALONG THE COAST IN THE SUMMER.  
THIS IS WHERE WE LIVE LIFE  
AS ALWAYS  
THIS IS WHERE WE FISH AND HUNT COASTAL BIRDS.  
BUT THE SEA IS A FICKLE NEIGHBOUR.  
WE MUST MAKE SACRIFICES TO THE GODS  
SO THEY FILL OUR TRAPS WITH FISH.

IM SOMMER LEBEN WIR AM STRAND.  
HIER IST DAS LEBEN  
DASSELBE WIE IMMER.  
HIER FISCHEN WIR UND JAGEN DIE KÜSTENVÖGEL.  
DOCH DAS MEER IST EIN LAUNISCHER NACHBAR.  
WIR MÜSSEN DEN GÖTTERN OPFER BRINGEN,  
DAMIT SIE UNS MILDE GESTIMMT SIND  
UND UNSERE REUSEN MIT FISCHEN FÜLLEN.



**SPECIAL APPLICATION  
SPECJALNE  
SPEZIELL PROFILE  
SPÉCIAL**



**LED ACCESSORIES**  
with T8 LED accessories  
ARC12 CD/US

# ARC12 CD/U5



max 12 mm



special application  
specjalny  
speziell  
spécial



furniture  
meblowe  
Möbel-  
mobilier

- flexible aluminium profile
- possibility of bending in two directions
- the profile keeps the shape of the bend
- minimum bending radius: 50 cm
- decorative and illuminating purpose of the profile
- possibility of using two diffusers - better light scattering
- possible outside installation (with D diffuser and waterproof LED strip used)

- aluminiowy profil do zastosowań giętych w dwóch kierunkach jednej płaszczyzny
- profil zachowujący kształt wygięcia
- minimalny promień gięcia: 50 cm
- profil dekoracyjno-oświetleniowy
- możliwość założenia dwóch kloszy - lepsze rozproszenie światła
- możliwość montażu zewnętrznego (przy zastosowaniu klosza D oraz taśmy wodoodpornej)

- ein Aluminiumprofil für Biegen in zwei Richtungen einer Ebene
- das Profil behält die Biegeform
- minimaler Biegungsradius: 50 cm
- Dekor- und Beleuchtungsprofil
- die Möglichkeit zwei Abdeckung anzuwenden - bessere Diffusion
- Montage im Außenbereich möglich (bei dem Anwenden einer D einclipsbaren Abdeckung und eines wasserdichten LED Streifens)

- profilé en aluminium pour applications pliables dans deux directions sur un même plan
- profilé qui maintient la forme du pli
- rayon de pli minimum : 50 cm
- profilé décoratif et lumineux
- possibilité d'installer deux diffuseurs - meilleure dispersion de la lumière
- possibilité d'installation externe (avec l'utilisation du diffuseur D et de ruban étanche)



more  
information

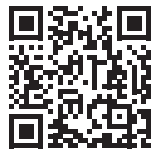

więcej  
szczegółów



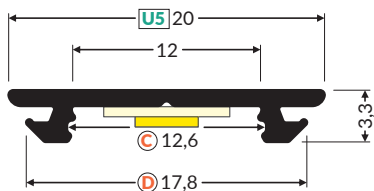

 sling  
 zawiesie  
 Abhängung  
 suspension  
 → 209

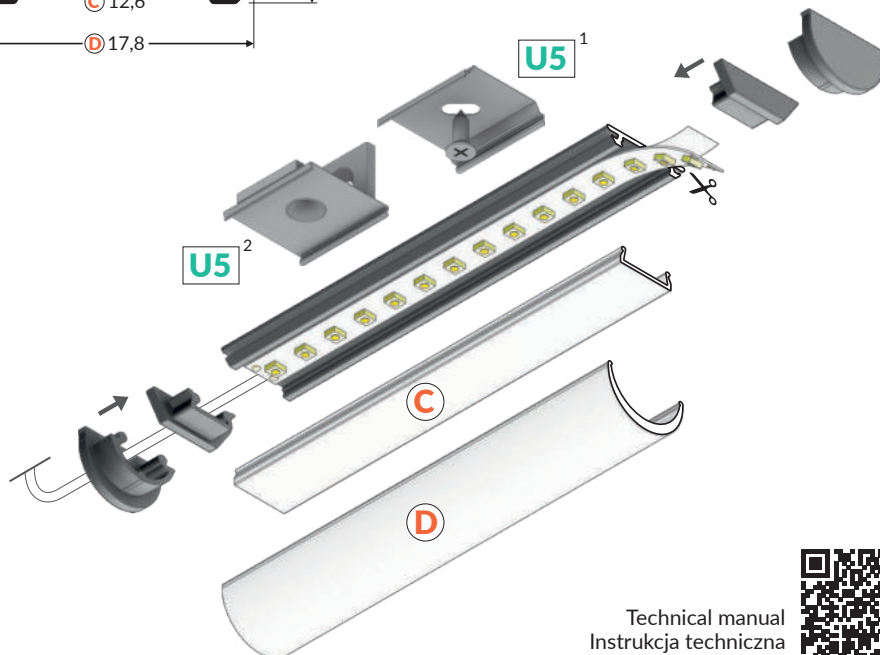

**U5**<sup>1</sup> → 205

mounting plate U5 cone  
 uchwył U5 cone  
 Halter U5 cone  
 fixation U5 cône

**U5**<sup>2</sup> → 205

mounting plate U5 side  
 uchwył U5 boczny  
 Halter U5 seitlich  
 fixation U5 latérale

**C** → 195

diffuser C click  
 klosz C klik  
 Abdeckung C einclipsbar  
 diffuseur C clic

**D** → 198

diffuser D click  
 klosz D klik  
 Abdeckung D einclipsbar  
 diffuseur D clic

Technical manual  
 Instrukcja techniczna  
 Technische Anleitung  
 Manuel technique



white painted  
 biały malowany  
 weiß lackiert  
 peint en blanc



anodized  
 anodowany  
 eloxiert  
 surface anodisée

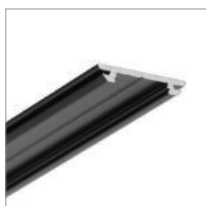

black painted  
 czarny malowany  
 schwarz lackiert  
 peint en noir



raw aluminium  
 surowe aluminium  
 Rohaluminium  
 aluminium brut

1000 mm	<b>B2000001</b>	<b>B2000020</b>	<b>B2000002</b>	<b>B2000000</b>
2000 mm	<b>B2010001</b>	<b>B2010020</b>	<b>B2010002</b>	<b>B2010000</b>
3000 mm	<b>B2060001</b>	<b>B2060020</b>	<b>B2060002</b>	<b>B2060000</b>
4050 mm	<b>B2070001</b>	<b>B2070020</b>	<b>B2070002</b>	<b>B2070000</b>

end cap ARC12  
 zaślepka ARC12  
 Endkappe ARC12  
 embout ARC12



white  
 biały  
 weiß  
 blanc  
**B2960001**

silver  
 srebrny  
 silbern  
 argent  
**B2960040**

black  
 czarny  
 schwarz  
 noir  
**B2960002**

grey  
 szary  
 grau  
 gris  
**B2960022**

end cap ARC12 D  
 zaślepka ARC12 D  
 Endkappe ARC12 D  
 embout ARC12 D



white  
 biały  
 weiß  
 blanc  
**B2980001**

silver  
 srebrny  
 silbern  
 argent  
**B2980040**

black  
 czarny  
 schwarz  
 noir  
**B2980002**

grey  
 szary  
 grau  
 gris  
**B2980022**





# PEN8 |

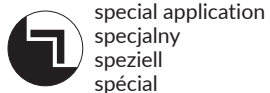

- decorative and lighting  
profile, eg. for glass cabinets  
- possibility of mounting  
between the walls of a cabinet

- profil dekoracyjno-  
oświetleniowy, np. do  
szklanych gablot  
- możliwość mocowania  
pomiędzy ściankami

- ein dekorativ-beleuchtendes  
Profil, z.B. für die Glasvitrinen  
- die Möglichkeit der Montage  
zwischen den Wänden

- profilé décoratif et lumineux,  
par ex. pour vitrines en verre  
- possibilité de montage entre  
deux murs



more  
information



więcej  
szczegółów



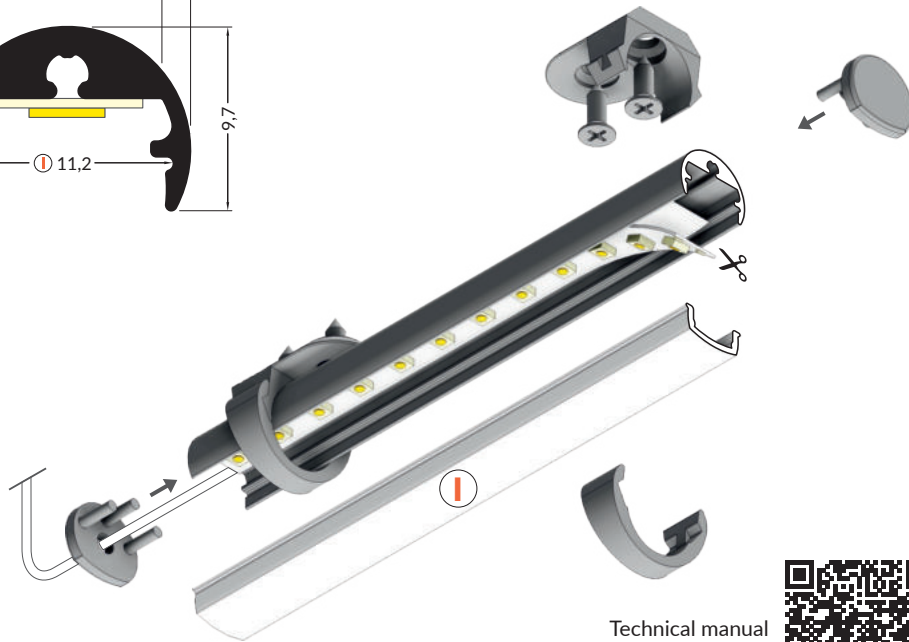
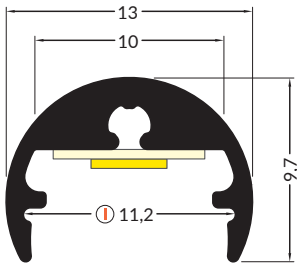

Technical manual  
Instrukcja techniczna  
Technische Anleitung  
Manuel technique



→ 200

diffuser I click  
klosz I klik  
Abdeckung I einclipsbar  
diffuseur I clic



anodized  
anodowany  
eloxiert  
surface anodisée

1000 mm	<b>86020020</b>
2000 mm	<b>86030020</b>
3000 mm	<b>86530020</b>
4050 mm	<b>86540020</b>

end cap PEN8  
zaślepka PEN8  
Endkappe PEN8  
embout PEN8



silver  
srebrny  
silbern  
argent  
**86490040**  
  
grey  
szary  
grau  
gris  
**86490022**

end cap PEN8 with hole  
zaślepka PEN8 z otworem  
Endkappe PEN8 mit Öffnung  
embout PEN8 avec un trou



silver  
srebrny  
silbern  
argent  
**86470040**  
  
grey  
szary  
grau  
gris  
**86070022**

holder PEN8 flat  
uchwyt PEN8 płaski  
Halter PEN8 flach  
fixation PEN8 plat

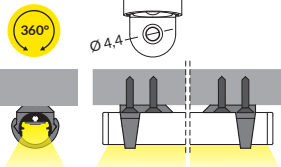
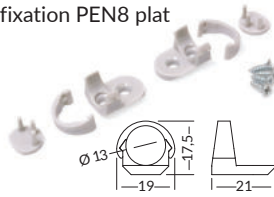

material: ABS  
materiał: ABS  
Material: ABS  
matériel: ABS

grey  
szary  
grau  
gris  
**86070022**

holder PEN8 simple  
uchwyt PEN8 prosty  
Halter PEN8 einfach  
fixation PEN8 simple

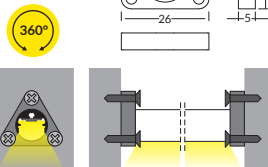
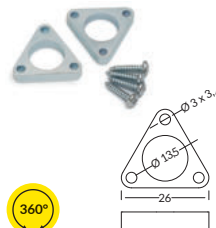

material: zinc coated steel  
materiał: stal ocynkowana  
Material: verzinkter Stahl  
matériel: acier galvanisé

zinc coated steel  
stal ocynkowana  
verzinkter Stahl  
acier galvanisé  
**86370030**

holder PEN8 ring  
uchwyt PEN8 ring  
Halter PEN8 Ring  
fixation PEN8 ring

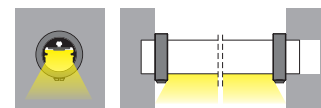
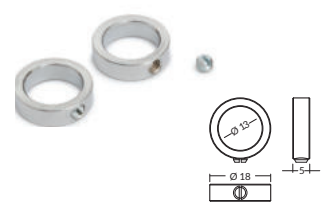

material: brass  
materiał: mosiądz  
Material: Messing  
matériel: laiton

chrome  
chrom  
Chrom  
chrome  
**86440003**

material: aluminium  
materiał: aluminium  
Material: Aluminium  
matériel: aluminium

raw aluminium  
surowe aluminium  
Rohaluminium  
aluminium brut  
**86440000**

# PEN12 CJ



max 12mm



special application  
specjalny  
speziell  
spécial



furniture  
meblowe  
Möbel-  
mobilier

- wall and furniture application  
- rotation allows you to direct  
the light

- ścienny i meblowy  
- obrotowość umożliwia  
ukierunkowanie światła

- für Wände und Möbel  
- Drehung ermöglicht es, das  
Licht zu lenken

- pour les murs et le mobilier  
- pivotant pour diriger la lumière



more  
information



więcej  
szczegółów





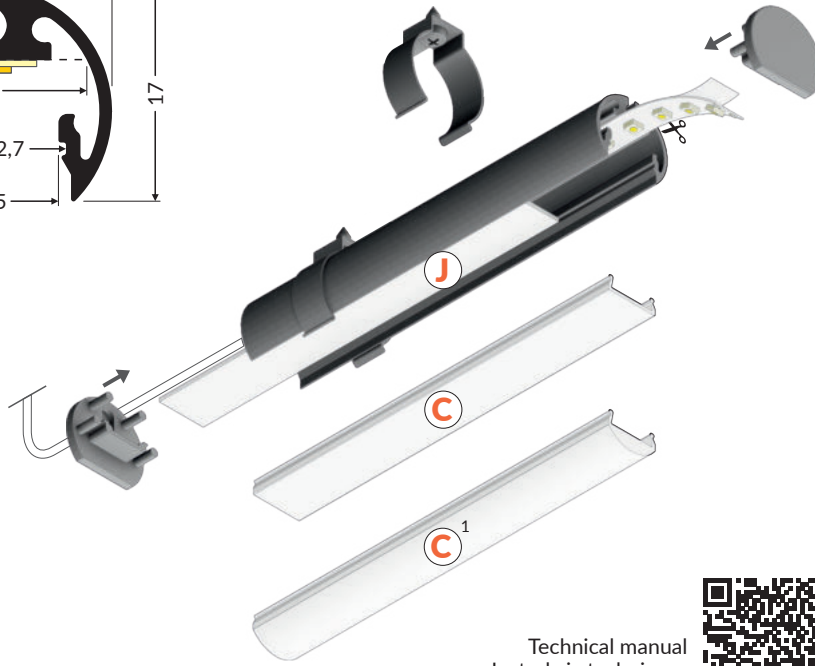
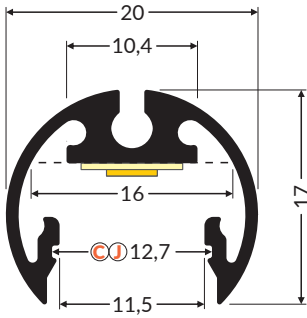

Technical manual  
Instrukcja techniczna  
Technische Anleitung  
Manuel technique



**J** → 200

diffuser J slide  
klosz J wsuwany  
Abdeckung J einschiebbar  
diffuseur J coulissant

**C** → 195

diffuser C click  
klosz C klik  
Abdeckung C einclipsbar  
diffuseur C clic

**C**<sup>1</sup> → 195

diffuser C click lens gen2  
klosz C klik soczewka gen2  
Abdeckung C einclipsbar Linse gen2  
diffuseur C clic lentille gen 2



white painted  
biały malowany  
weiß lackiert  
peint en blanc



anodized  
anodowany  
eloxiert  
surface anodisée



black painted  
czarny malowany  
schwarz lackiert  
peint en noir

1000 mm	<b>F7000101</b>	<b>F7000120</b>	<b>F7000102</b>
2000 mm	<b>F7000201</b>	<b>F7000220</b>	<b>F7000202</b>
3000 mm	<b>F7000301</b>	<b>F7000320</b>	<b>F7000302</b>
4050 mm	<b>F7000401</b>	<b>F7000420</b>	<b>F7000402</b>

end cap PEN12  
zaślepka PEN12  
Endkappe PEN12  
embout PEN12



white  
biały  
weiß  
blanc  
**F7009901**

silver  
srebrny  
silbern  
argent  
**F7009940**

black  
czarny  
schwarz  
noir  
**F7009902**

grey  
szary  
grau  
gris  
**F7009922**

holder PEN12 flat  
uchwyt PEN12 płaski  
Halter PEN12 flach  
fixation PEN12 plat

material: stainless steel  
materiał: stal nierdzewna  
Material: rostfreier Stahl  
matériel: acier inoxydable

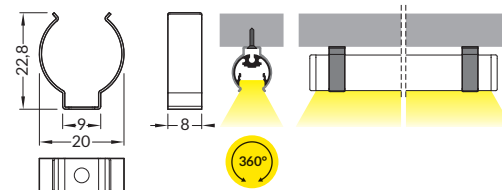

inox  
**F7009019**

holder PEN12 ring  
uchwyt PEN12 ring  
Halter PEN12 Ring  
fixation PEN12 ring

material: brass  
materiał: mosiądz  
Material: Messing  
matériel: laiton

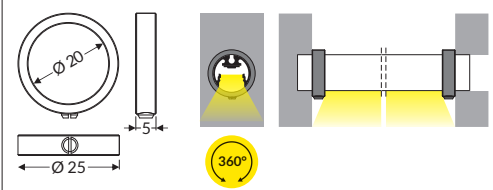

chrome  
chrom  
Chrom  
chrome  
**F7009203**

# BACK10 A/UX



max 10 mm



special application  
specjalny  
speziell  
spécial



furniture  
meblowe  
Möbel-  
mobilier

- decorative illumination
- the T-shaped structure makes possible to direct the light beam in two directions (up/down, left/right)
- mounting with two dedicated holders (to the wall) or directly to the piece of furniture, using screws
- optionally, the A diffuser can be used

- oświetlenie dekoracyjne
- konstrukcja w kształcie litery "T" pozwala na skierowanie strumienia świetlnego w dwóch kierunkach (góra/dół, lewo/prawo)
- mocowanie za pomocą dedykowanych uchwytów (do ściany) lub bezpośrednio przy pomocy wkrętów (do mebla)
- opcjonalne użycie klosza A

- dekorative Beleuchtung
- Konstruktion in der Form des Buchstabens "T" ermöglicht den Lichtstrom in zwei Richtungen zu richten (oben/unten, links/rechts)
- Befestigung mit Hilfe von gewidmeten Haltern (an der Wand) oder direkt mit Hilfe der Schrauben (am Möbel)
- eine optionale Anwendung der Abdeckung A

- éclairage décoratif
- la conception en forme de «T» permet au faisceau lumineux d'être dirigé dans deux directions (haut/bas, gauche/droite)
- montage avec des fixations dédiées (au mur) ou directement avec des vis (au meuble)
- utilisation optionnelle du diffuseur A



more  
information



więcej  
szczegółów



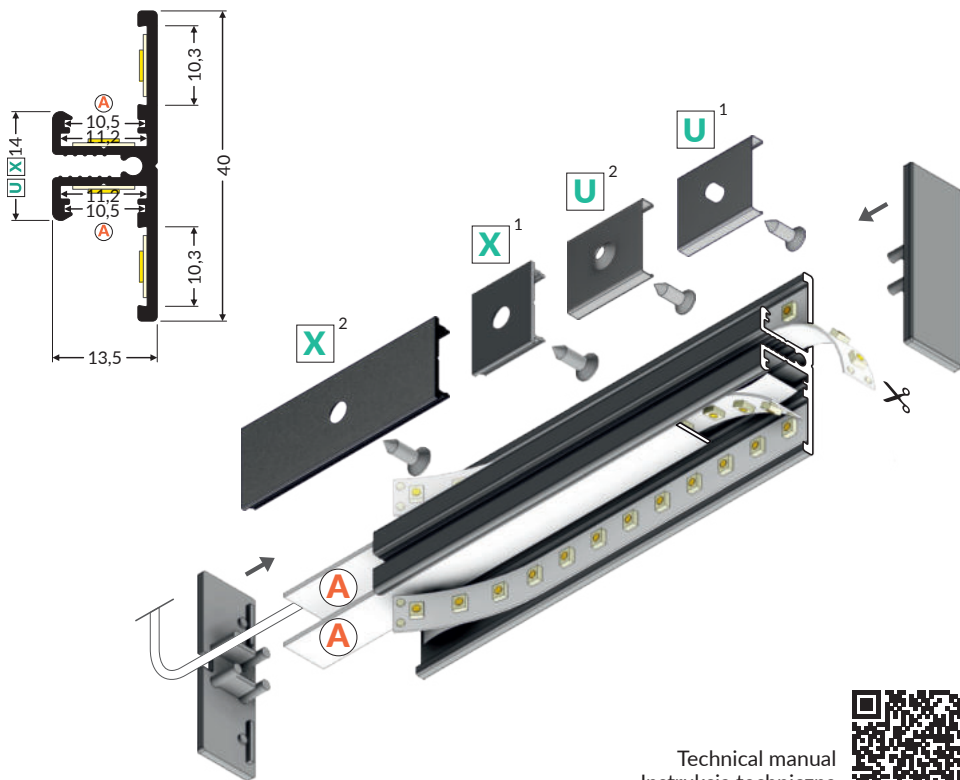

Technical manual  
Instrukcja techniczna  
Technische Anleitung  
Manuel technique



**U**<sup>1</sup> → 204

mounting plate U  
uchwyt U  
Halter U  
fixation U

**U**<sup>2</sup> → 204

mounting plate U cone  
uchwyt U cone  
Halter U cone  
fixation U cône

**X**<sup>1</sup> → 207

mounting plate X  
uchwyt X  
Halter X  
fixation X

**X**<sup>2</sup> → 207

connector X 180 deg  
łącznik X 180 st  
Verbinder X 180 Grad  
connecteur X 180 degrés

**A** → 194

diffuser A slide  
klosz A wsuwany  
Abdeckung A einschiebbar  
diffuseur A coulissant



white painted  
biały malowany  
weiß lackiert  
peint en blanc



anodized  
anodowany  
eloxiert  
surface anodisée



black painted  
czarny malowany  
schwarz lackiert  
peint en noir



raw aluminium  
surowe aluminium  
Rohaluminium  
aluminium brut

1000 mm	90020001	90020020	90020002	90020000
2000 mm	90030001	90030020	90030002	90030000
3000 mm	90170001	90170020	90170002	90170000
4050 mm	90180001	90180020	90180002	90180000

end cap BACK10  
zaślepka BACK10  
Endkappe BACK10  
embout BACK10



white biały weiß blanc	silver srebrny silbern argent
90100001	90100040

black czarny schwarz noir	grey szary grau gris
90100002	90100022

end cap BACK10 with hole  
zaślepka BACK10 z otworem  
Endkappe BACK10 mit Öffnung  
embout BACK10 avec un trou



white biały weiß blanc	silver srebrny silbern argent
90150001	90150040

black czarny schwarz noir	grey szary grau gris
90150002	90150022





# WAY10 C



max 10 cm



special application  
specjalny  
speziell  
spécial



architectural  
architektoniczne  
architektonisch  
pour le batiment

- strip for illuminating passageways
- dedicated for wall mounting
- hidden mounting and wiring
- curved shape

- listwa do podświetlania ciągów komunikacyjnych
- dedykowany do montażu ściennego
- ukryte mocowanie i przewody
- obta forma

- Sockelleiste zur Beleuchtung von Durchgängen
- speziell für die Wandmontage
- verdeckte Befestigung und Verkabelung
- abgerundete Form

- plinthe pour éclairer les passages de circulation
- dédié au montage mural
- fixation et câblage cachés
- forme arrondie



more  
information



więcej  
szczegółów



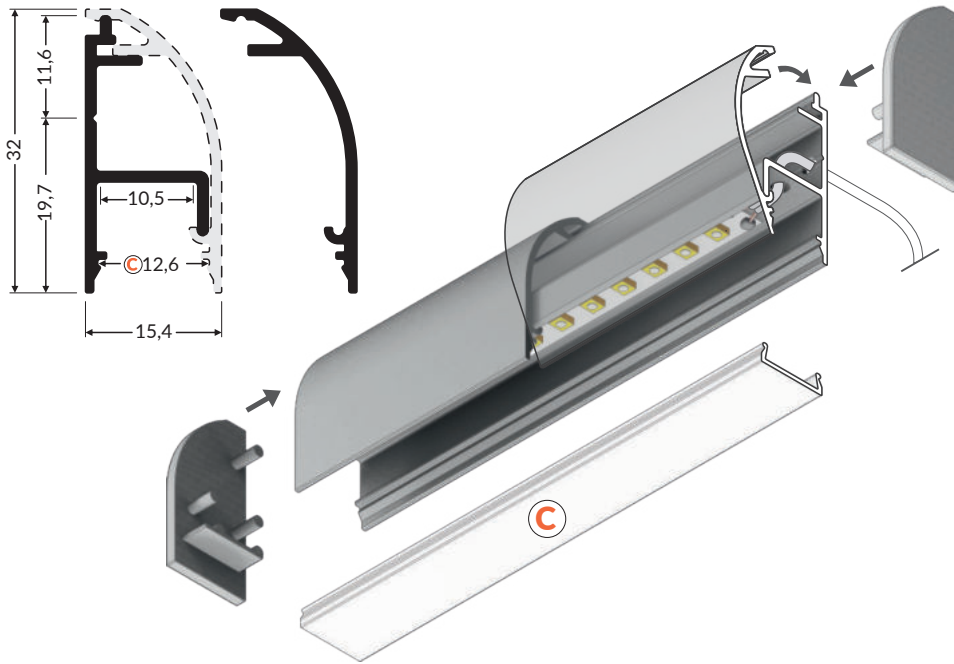

**C** → 195

diffuser C click  
klosz C klik  
Abdeckung C einclipsbar  
diffuseur C clic

Technical manual  
Instrukcja techniczna  
Technische Anleitung  
Manuel technique



LED profile WAY10  
profil LED WAY10  
LED Profil WAY10  
profilé LED WAY10

cover WAY10  
osłona WAY10  
Abdeckplatte WAY10  
cache WAY10



anodized  
anodowany  
eloxiert  
surface anodisée

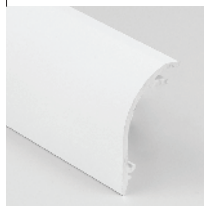

white painted  
biały malowany  
weiß lackiert  
peint en blanc



anodized  
anodowany  
eloxiert  
surface anodisée

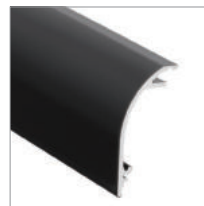

black painted  
czarny malowany  
schwarz lackiert  
peint en noir



raw aluminium  
surowe aluminium  
Rohaluminium  
aluminium brut

1000 mm	<b>F9000120</b>	<b>F9000501</b>	<b>F9000520</b>	<b>F9000502</b>	<b>F9000500</b>
2000 mm	<b>F9000220</b>	<b>F9000601</b>	<b>F9000620</b>	<b>F9000602</b>	<b>F9000600</b>
3000 mm	<b>F9000320</b>	<b>F9000701</b>	<b>F9000720</b>	<b>F9000702</b>	<b>F9000700</b>
4050 mm	<b>F9000420</b>	<b>F9000801</b>	<b>F9000820</b>	<b>F9000802</b>	<b>F9000800</b>

end cap WAY10  
zaślepka WAY10  
Endkappe WAY10  
embout WAY10



white  
biały  
weiß  
blanc  
**F9009901**

silver  
srebrny  
silbern  
argent  
**F9009940**

black  
czarny  
schwarz  
noir  
**90100002**

grey  
szary  
grau  
gris  
**F9009922**



# WALLE12 BCD



max 12 mm



special application  
specjalny  
speziell  
spécial



architectural  
architektoniczne  
architektonische  
pour le batiment

- mounted directly to a wall or ceiling
- 7 types of matching diffusers
- possibility of outdoor using (with D diffuser and waterproof LED strip)

- montowany bezpośrednio do ściany lub sufitu
- 7 rodzajów pasujących kloszy
- możliwość zastosowania zewnętrznego (przy użyciu klosza D i taśmy wodoodpornej)

- direkt an der Wand oder Decke montiert
- 7 Abdeckungen zur Wahl
- Montage im Außenbereich möglich (bei dem Anwenden einer D einclipsbaren Abdeckung und eines wasserdichten LED Streifens)

- monté directement au mur ou au plafond
- 7 types de diffuseurs assortis
- possibilité d'utilisation externe (à l'aide du diffuseur D et de ruban étanche)



more  
information



więcej  
szczegółów

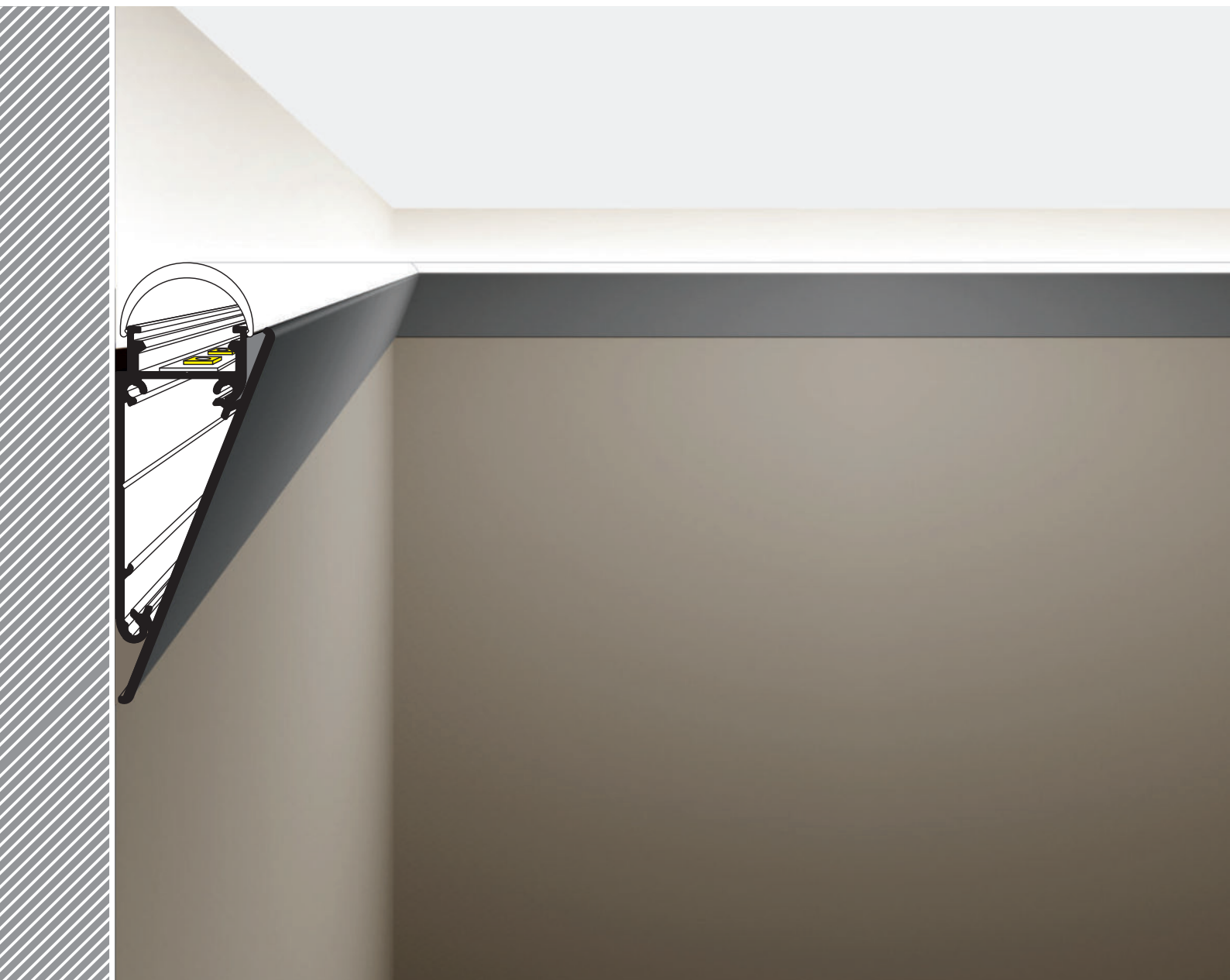



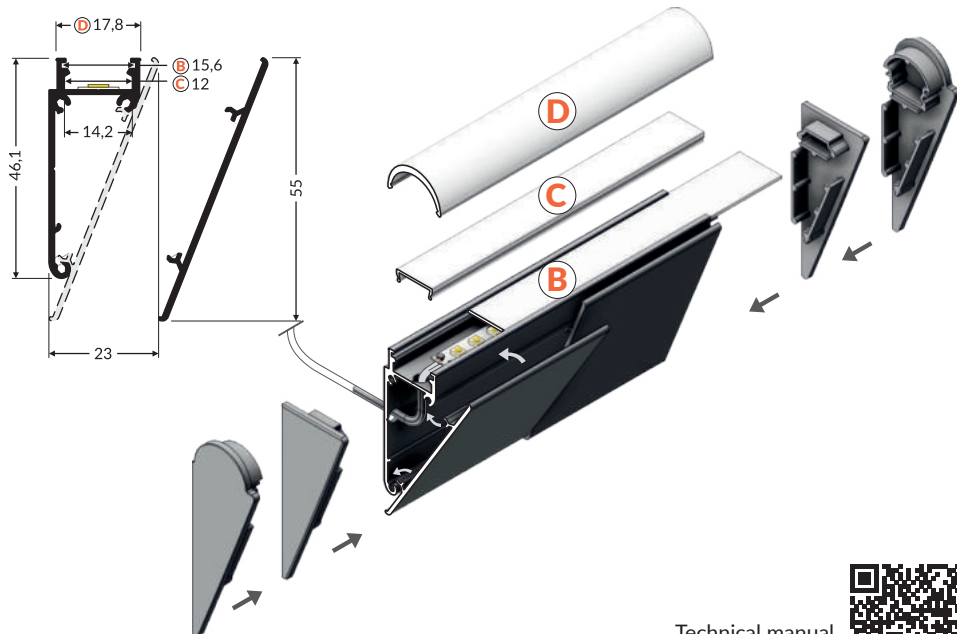

**D** → 198

diffuser D click  
klosz D klik  
Abdeckung D einclipsbar  
diffuseur D clic

**C** → 195

diffuser C click  
klosz C klik  
Abdeckung C einclipsbar  
diffuseur C clic

**B** → 194

diffuser B slide  
klosz B wsuwany  
Abdeckung B einschiebbar  
diffuseur B coulissant

Technical manual  
Instrukcja techniczna  
Technische Anleitung  
Manuel technique



LED profile WALLE12  
profil LED WALLE12  
LED Profil WALLE12  
profilé LED WALLE12



white painted  
biały malowany  
weiß lackiert  
peint en blanc

1000 mm **B8050001**  
2000 mm **B8060001**  
3000 mm **B8090001**  
4050 mm **B8100001**



anodized  
anodowany  
eloxiert  
surface anodisée

**B8010020**  
**B8020020**  
**B8090020**  
**B8100020**



raw aluminium  
surowe aluminium  
Rohaluminium  
aluminium brut

**B8010000**  
**B8020000**  
**B8090000**  
**B8100000**

cover WALLE12  
ośona WALLE12  
Abdeckplatte WALLE12  
cache WALLE12



white painted  
biały malowany  
weiß lackiert  
peint en blanc

**B8070001**  
**B8080001**  
**B8110001**  
**B8120001**



anodized  
anodowany  
eloxiert  
surface anodisée

**B8030020**  
**B8040020**  
**B8110020**  
**B8120020**

end cap WALLE12  
zaślepka WALLE12  
Endkappe WALLE12  
embout WALLE12



white  
biały  
weiß  
blanc

**B8900001**  
**B8900040**  
  
grey  
szary  
grau  
gris  
**B8900022**

silver  
srebrny  
silbern  
argent

**B8900040**

end cap WALLE12 D  
zaślepka WALLE12 D  
Endkappe WALLE12 D  
embout WALLE12 D



white  
biały  
weiß  
blanc

**B8890001**  
**B8890040**  
  
grey  
szary  
grau  
gris  
**B8890022**

silver  
srebrny  
silbern  
argent

**B8890040**

connector WALLE12 180 deg  
łącznik WALLE12 180 st  
Verbinder WALLE12 180 Grad  
connecteur WALLE12 180 degrés

material: stainless steel  
materiał: stal nierdzewna  
Material: rostfreier Stahl  
matériel: acier inoxydable

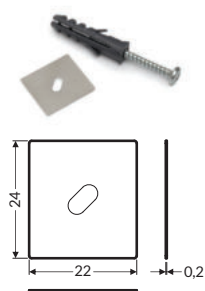

inox  
**B8950019**

connector WALLE12 90 deg  
łącznik WALLE12 90 st  
Verbinder WALLE12 90 Grad  
connecteur WALLE12 90 degrés

material: aluminium  
materiał: aluminium  
Material: Aluminium  
matériel: aluminium

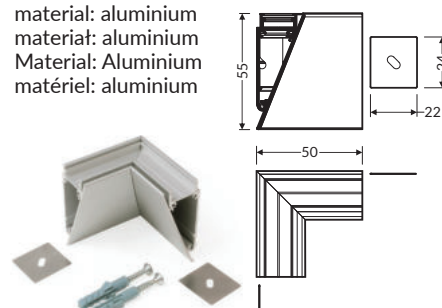

white painted  
biały malowany  
weiß lackiert  
peint en blanc  
**B8910001**

anodized  
anodowany  
eloxiert  
surface anodisée  
**B8910020**



max 10 mm



special application  
specjalny  
speziell  
spécial



architectural  
architektoniczne  
architektonische  
pour le batiment

- for the illumination of steps and their edges
- basic and compact (one-piece)
- without any glare effect
- anti-slip ribbing
- socket with Slick function outline

- do oświetlania stopni i wykończenia ich krawędzi
- podstawowy i kompaktowy (jednoelementowy)
- bez efektu olśnienia
- antypoślizgowe żebrowanie
- gniazdo z funkcją Slick

- zur Beleuchtung von Stufen und Treppenkanten
- einfach und kompakt (Einzelelement)
- ohne Blendeffekt
- rutschfeste Rippenfläche
- Sockel mit Slick-Funktion

- pour éclairer les marches et finir leurs bords
- basique et compact (en 1 seule pièce)
- sans effet d'éblouissement
- rainures antidérapantes
- prise avec fonction Slick



more  
information



więcej  
szczegółów



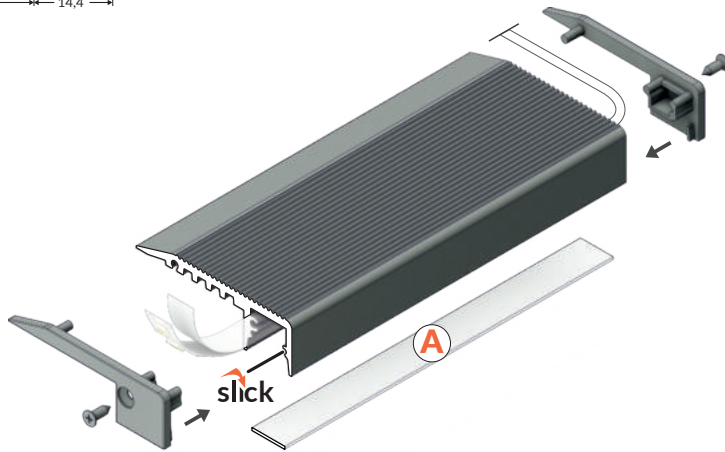
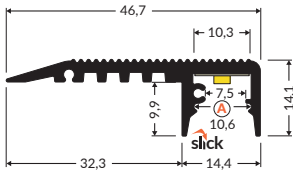

**A** → 194

diffuser A slide  
klosz A wsuwany  
Abdeckung A einschiebbar  
diffuseur A coulissant



anodized  
anodowany  
eloxiert  
surface anodisée

1000 mm	J9000120
2000 mm	J9000220
3000 mm	J9000320
4050 mm	J9000420

end cap UP-MINI10  
zaślepka UP-MINI10  
Endkappe UP-MINI10  
embout UP-MINI10



silver  
srebrny  
silbern  
argent  
J9999940

grey  
szary  
grau  
gris  
J9999922





# UP-BOLD12 K

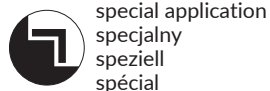

- for accentuating step edges
- simple, reinforced profile design (one-piece)
- reinforced K shade
- for use in areas with increased levels of movement (e.g. cinemas, theatres, etc.)
- good light diffusion (even with 60 P/m strip)
- anti-slip ribbing

- do akcentowania krawędzi stopni
- prosta, wzmocniona konstrukcja profilu (jednoelementowy)
- wzmocniony klosz K
- do stosowania przy zwiększonym natężeniu ruchu (np. kina, teatry itp.)
- dobre rozproszenie światła (nawet przy taśmie 60 P/m)

- zur Hervorhebung von Treppenkanten
- einfache, verstärkte Profilkonstruktion (Einzelement)
- verstärkte Abdeckung K
- zur Anwendung bei großer Verkehrsdichte (z.B. Kinos, Theater usw.)
- gute Lichtstreuung (auch beim Streifen 60 P/m)
- rutschfeste Rippenfläche

- pour accentuer les bords des marches
- construction de profilé simple et renforcée (en 1 seule pièce)
- cloche K renforcée
- pour utiliser avec circulation intense (p.ex. cinémas, théâtres etc.)
- bonne dispersion de la lumière (même avec une bande 60 P/m)



more  
information



więcej  
szczegółów

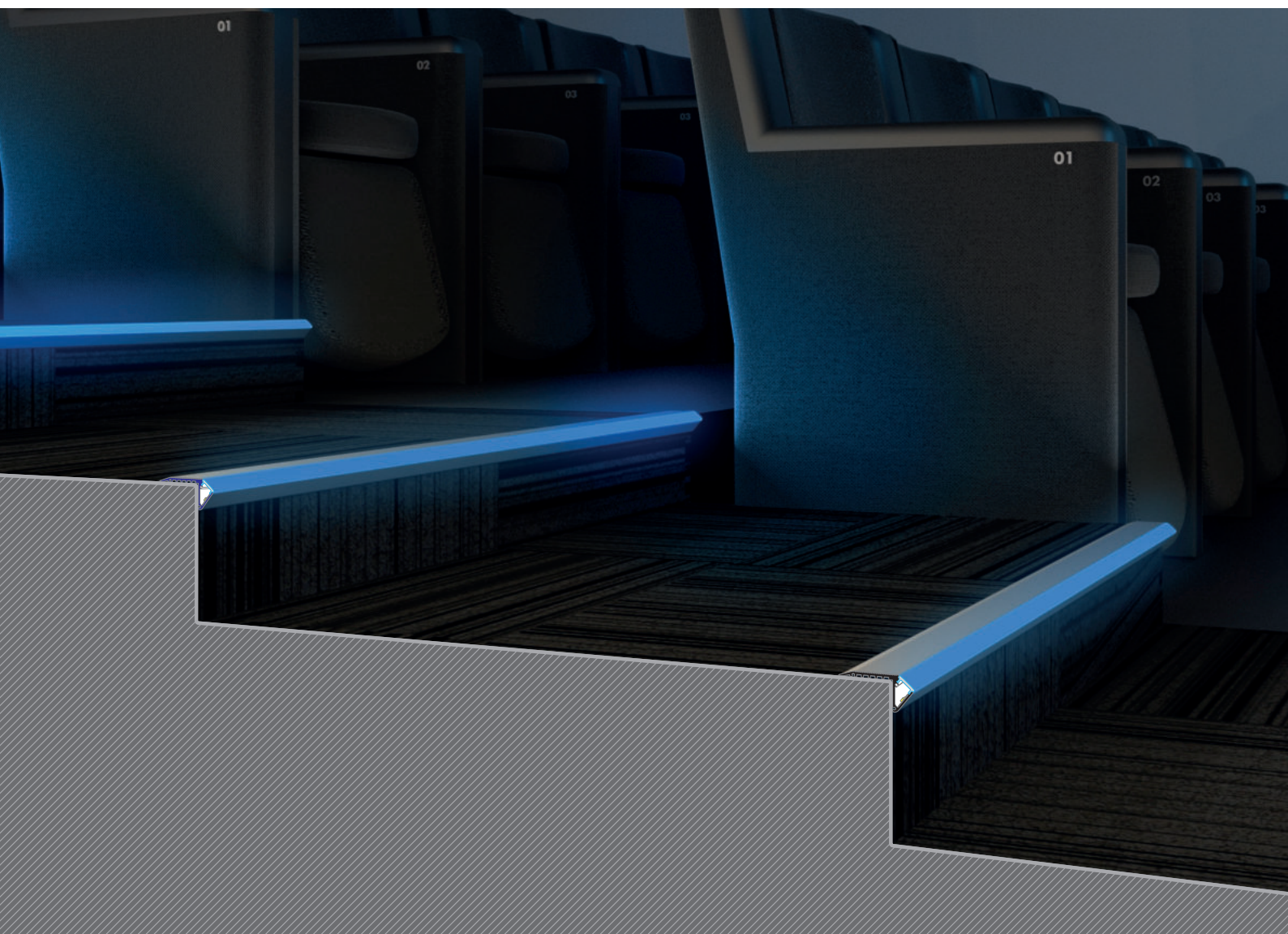

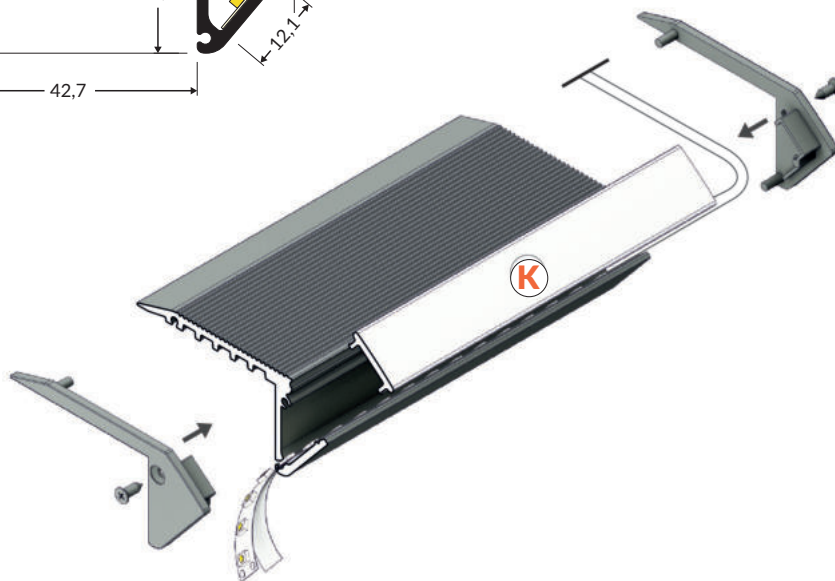
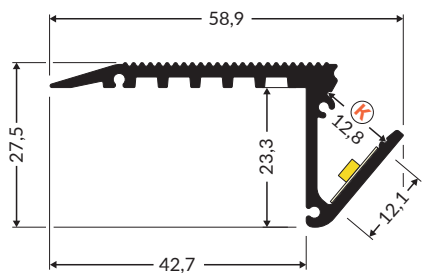

**K** → 200

diffuser K click  
 klosz K klik  
 Abdeckung K einclipsbar  
 diffuseur K clic



anodized  
 anodowany  
 eloxiert  
 surface anodisée



black painted  
 czarny malowany  
 schwarz lackiert  
 peint en noir

1000 mm	<b>J4000120</b>	<b>J4000102</b>
2000 mm	<b>J4000220</b>	<b>J4000202</b>
3000 mm	<b>J4000320</b>	<b>J4000302</b>
4050 mm	<b>J4000420</b>	<b>J4000402</b>

end cap UP-BOLD12  
 zaślepka UP-BOLD12  
 Endkappe UP-BOLD12  
 embout UP-BOLD12



silver srebrny silbern argent	black czarny schwarz noir
<b>J4999940</b>	<b>J4999902</b>

grey szary grau gris
<b>J4999922</b>





# SKIRT10 AC2/Q9



max 10 mm



special application  
specjalny  
speziell  
spécial



architectural  
architektoniczne  
architektonisch  
pour le batiment

- elegant and robust skirting board for LED strips
- soft glow with a 60 P/m LED strip
- optimum light effect with a matt floor or carpet
- convenient installation
- space for concealing wires

- elegancka i solidna listwa przypodłogowa do taśm LED
- miękka łuna światła z taśmą LED 60 P/m
- optymalny efekt świetlny przy podłodze matowej, wykładzinie
- wygodny montaż
- miejsce na ukrycie przewodów

- elegante und robuste Sockelleiste für LED Streifen
- sanfter Lichtschein mit LED-Streifen 60 P/m
- optimaler Lichteffect mit mattem Fußboden oder Teppichboden
- komfortable Montage
- Platz zum Verstecken von Kabeln

- plinthe élégante et résistante pour les rubans LED
- effet lumineux doux avec le ruban LED 60 P/m
- effet de lumière optimal avec un sol mat ou une moquette
- installation pratique
- endroit pour cacher les fils



more  
information



więcej  
szczegółów





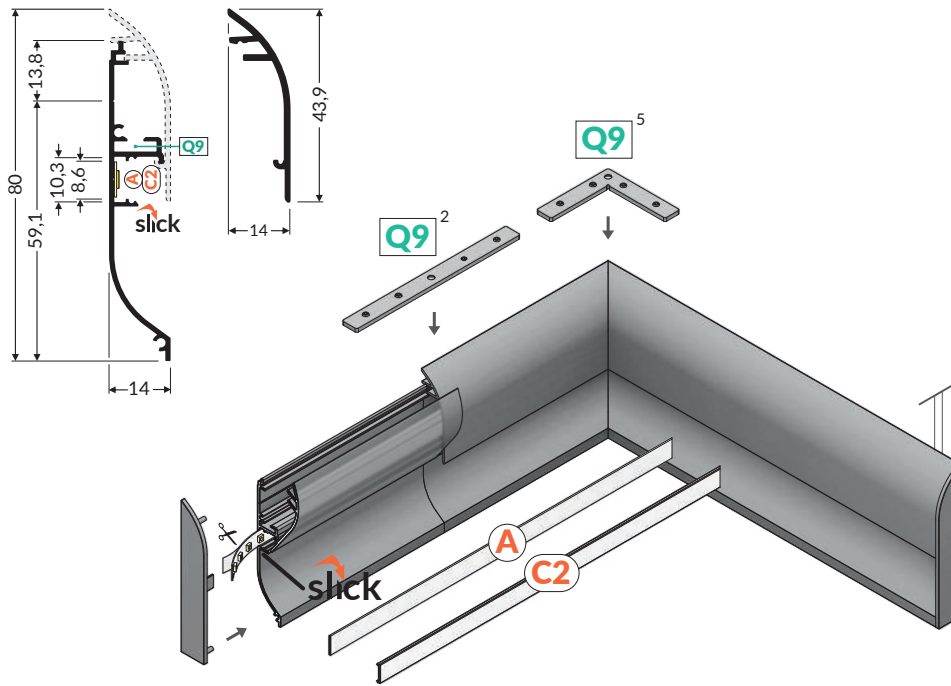

Technical manual  
Instrukcja techniczna  
Technische Anleitung  
Manuel technique



LED profile SKIRT10  
profil LED SKIRT10  
LED Profil SKIRT10  
profilé LED SKIRT10

white painted biały malowany weiß lackiert peint en blanc	anodized anodowany eloxiert surface anodisée	raw aluminium surowe aluminium Rohaluminium aluminium brut	
1000 mm	J2000101	J2000120	J2000100
2000 mm	J2000201	J2000220	J2000200
3000 mm	J2000301	J2000320	J2000300
4050 mm	J2000401	J2000420	J2000400

complementary profile SKIRT10  
profil uzupełniający SKIRT10  
Ergänzungsprofil SKIRT10  
cache SKIRT10

white painted biały malowany weiß lackiert peint en blanc	anodized anodowany eloxiert surface anodisée	raw aluminium surowe aluminium Rohaluminium aluminium brut	
1000 mm	J2000501	J2000520	J2000500
2000 mm	J2000601	J2000620	J2000600
3000 mm	J2000701	J2000720	J2000700
4050 mm	J2000801	J2000820	J2000800

end cap SKIRT10  
zaślepka SKIRT10  
Endkappe SKIRT10  
embout SKIRT10



white biały weiß blanc	silver srebrny silbern argent	grey szary grau gris
J2998901	J2998940	J2998922

**Q9**<sup>1</sup> → 203

connector Q9 90 deg bent  
łącznik Q9 90 st gięty  
Verbinder Q9 90 Grad gebogen  
connecteur Q9 90 degrés pliable

**Q9**<sup>2</sup> → 203

connector Q9 180 deg  
łącznik Q9 180 st  
Verbinder Q9 180 Grad  
connecteur Q9 180 degrés

**Q9**<sup>3</sup> → 203

connector Q9 135 deg  
łącznik Q9 135 st  
Verbinder Q9 135 Grad  
connecteur Q9 135 degrés

**Q9**<sup>4</sup> → 203

connector Q9 120 deg  
łącznik Q9 120 st  
Verbinder Q9 120 Grad  
connecteur Q9 120 degrés

**Q9**<sup>5</sup> → 203

connector Q9 90 deg  
łącznik Q9 90 st  
Verbinder Q9 90 Grad  
connecteur Q9 90 degrés

**Q9**<sup>6</sup> → 203

connector Q9 60 deg  
łącznik Q9 60 st  
Verbinder Q9 60 Grad  
connecteur Q9 60 degrés

**Q9**<sup>7</sup> → 203

connector Q9 45 deg  
łącznik Q9 45 st  
Verbinder Q9 45 Grad  
connecteur Q9 45 degrés

**A** → 194

diffuser A slide  
klosz A wsuwany  
Abdeckung A einziehbar  
diffuseur A coulissant

**C2** → 196

diffuser C2 click  
klosz C2 klik  
Abdeckung C2 einclipsbar  
diffuseur C2 clic

# BASE



special application  
specjalny  
speziell  
spécial



architectural  
architektoniczne  
architektonisch  
pour le bâtiment

- basic aluminium skirting board
- matches the SKIRT10 skirting board
- for all types of floors
- more durable and moisture-resistant (compared to MDF and wooden skirting boards)
- space for concealing wires

- podstawowa, aluminiowa listwa przypodłogowa
- stylistyczne uzupełnienie listwy przypodłogowej SKIRT10
- do wszystkich rodzajów podłóg
- wyższa trwałość i odporność na wilgoć (w porównaniu z listwami MDF i drewnianymi)
- miejsce na ukrycie przewodów

- Basis-Aluminium-Sockelleiste
- eine stilistische Ergänzung zur Sockelleiste SKIRT10
- für alle Arten von Fußboden
- höhere Haltbarkeit und Feuchtigkeitsbeständigkeit (im Vergleich zu MDF- und Holzleisten)
- Platz zum Verstecken von Leitungen

- plinthe en aluminium de base
- un complément stylistique à la plinthe SKIRT10
- pour tous les types de revêtements de sol
- meilleure durabilité et résistance à l'humidité (par rapport au MDF et aux plinthes en bois)
- endroit pour cacher les fils



more  
information



więcej  
szczegółów



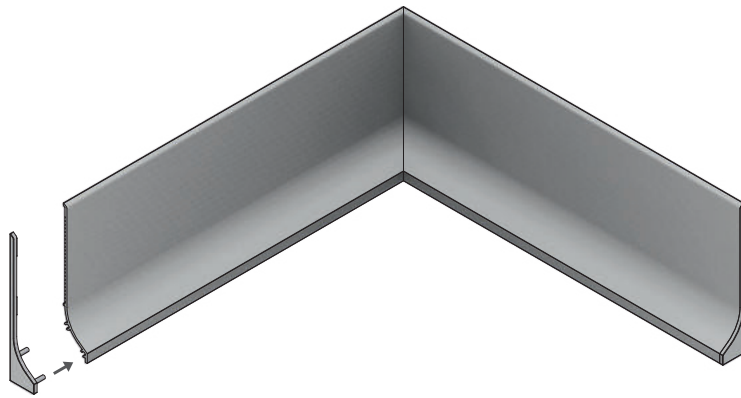
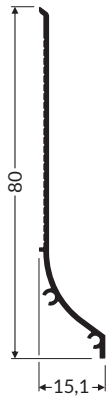

Technical manual  
Instrukcja techniczna  
Technische Anleitung  
Manuel technique



white painted  
biały malowany  
weiß lackiert  
peint en blanc



anodized  
anodowany  
eloxiert  
surface anodisée



raw aluminium  
surowe aluminium  
Rohaluminium  
aluminium brut

1000 mm	<b>J1000101</b>	<b>J1000120</b>	<b>J1000100</b>
2000 mm	<b>J1000201</b>	<b>J1000220</b>	<b>J1000200</b>
3000 mm	<b>J1000301</b>	<b>J1000320</b>	<b>J1000300</b>
4050 mm	<b>J1000401</b>	<b>J1000420</b>	<b>J1000400</b>

end cap BASE  
zaślepka BASE  
Endkappe BASE  
embout BASE



white  
biały  
weiß  
blanc  
**J1998901**

silver  
srebrny  
silbern  
argent  
**J1998940**

grey  
szary  
grau  
gris  
**J1998922**





# FIX12, FIX16



special application  
specjalny  
speziell  
spécial



furniture  
meblowe  
Möbel-  
mobilier

- the simplest installation of a LED strip
- function of radiator
- improves LED strip's adhesion
- minimal height of the profile
- budget profile, to be used without a diffuser
- maximum width of LED strip: 12 mm (FIX12) and 16 mm (FIX16)
- it can also function as a mounting profile:  
FIX12 for profiles with X socket  
FIX16 for profiles with T socket  
outline

- najprostsze mocowanie taśmy LED
- funkcja radiatora
- trwalsze przyleganie taśmy LED
- minimalna wysokość profilu
- profil budżetowy, do użycia bez klosza
- maksymalna szerokość taśmy LED: 12 mm (FIX12) oraz 16 mm (FIX16)
- może pełnić również funkcję montażową:  
FIX12 dla profili z gniazdem X  
FIX16 dla profili z gniazdem T

- die einfachste Installation eines LED Streifens
- Wärmeabfuhrfunktion
- festeres Haften des LED Streifens
- die minimale Höhe des Profils
- ein Budget-Profil für die Anwendung ohne Abdeckung
- maximale Breite des LED Streifens: 12 mm (FIX12) und 16 mm (FIX16)
- es kann auch die Montagefunktion erfüllen:  
FIX12 für die Profile mit Sockel X  
FIX16 für die Profile mit Sockel T

- la plus simple installation de ruban LED
- fonction de dissipateur
- meilleure adhérence de ruban LED
- profilé d'une hauteur minimale
- profilé économique, à utiliser sans diffuseur
- largeur maximale de ruban LED : 12 mm (FIX12) et 16 mm (FIX16)
- il peut également effectuer une fonction d'assemblage:  
FIX12 pour les profilés avec fixation X  
FIX16 pour les profilés avec fixation T



# FIX12



special application  
specjalny  
speziell  
spécial

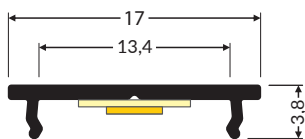

anodized  
anodowany  
eloxiert  
surface anodisée



raw aluminium  
surowe aluminium  
Rohaluminium  
aluminium brut

1000 mm	<b>87020020</b>	<b>87020000</b>
2000 mm	<b>87030020</b>	<b>87030000</b>
3000 mm	<b>87040020</b>	<b>87040000</b>
4050 mm	<b>87050020</b>	<b>87050000</b>



more  
information



więcej  
szczegółów

# FIX16



special application  
specjalny  
speziell  
spécial

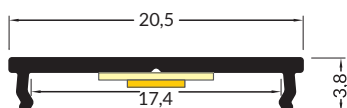

white painted  
biały malowany  
weiß lackiert  
peint en blanc



anodized  
anodowany  
eloxiert  
surface anodisée

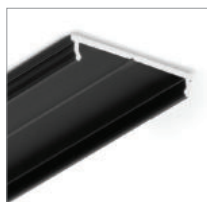

black anodized  
czarny anodowany  
schwarz eloxiert  
noir anodisé



raw aluminium  
surowe aluminium  
Rohaluminium  
aluminium brut

1000 mm	<b>C6010001</b>	<b>C6010020</b>	<b>C6010021</b>	<b>C6010000</b>
2000 mm	<b>C6020001</b>	<b>C6020020</b>	<b>C6020021</b>	<b>C6020000</b>
3000 mm	<b>C6030001</b>	<b>C6030020</b>	<b>C6030021</b>	<b>C6030000</b>
4050 mm	<b>C6040001</b>	<b>C6040020</b>	<b>C6040021</b>	<b>C6040000</b>



more  
information



więcej  
szczegółów







ACCESSORIES  
AKCESORIA  
ZUBEHÖR  
ACCESSOIRES

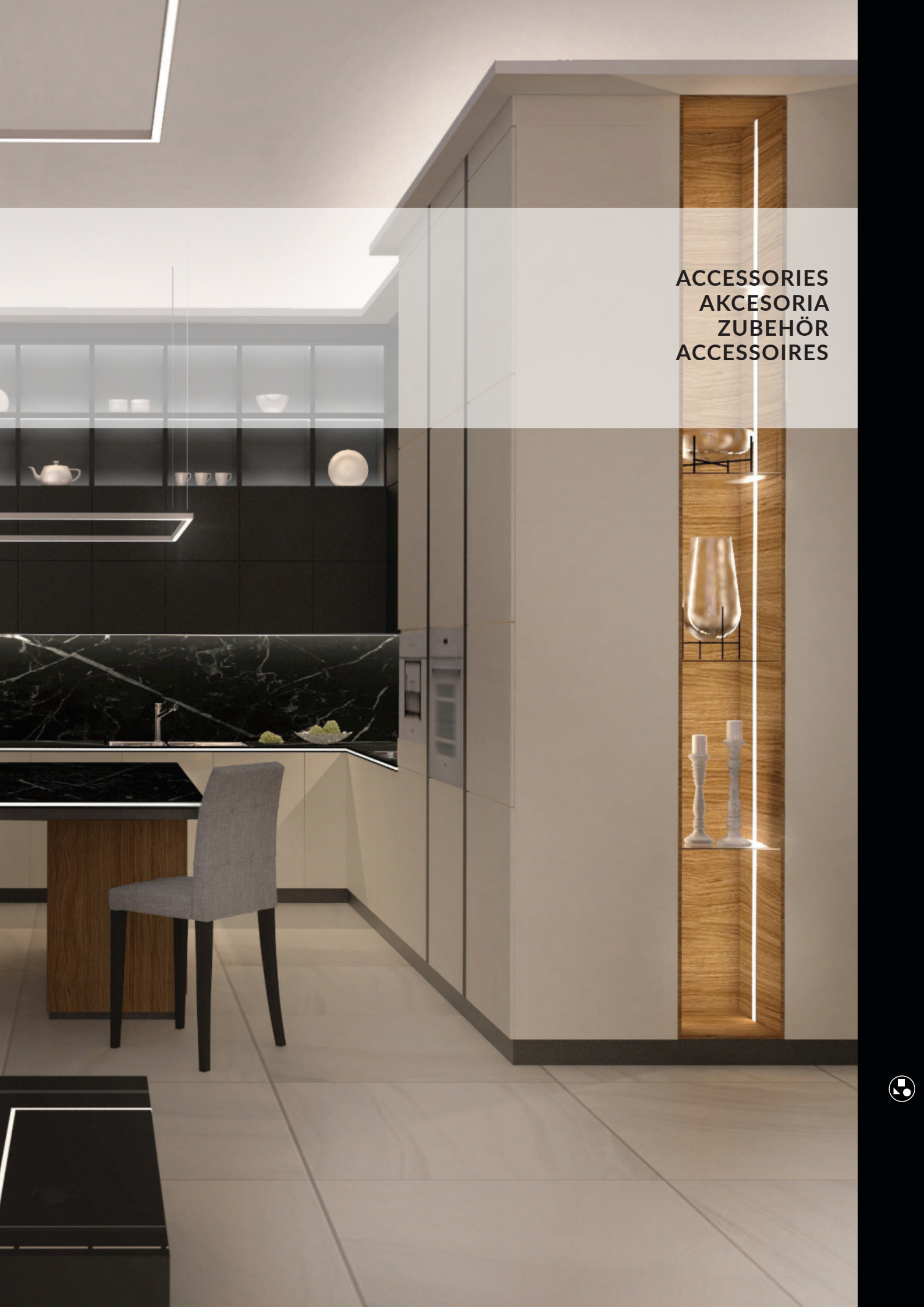

# DIFFUSERS KLOSZE ABDECKUNG DIFFUSEURS

**A**

diffuser A slide  
klosz A wsuwany  
Abdeckung A einschiebbar  
diffuseur A coulissant

SLIM8 AC2/Z → 32      UP-TILE10 A → 162  
SMART10 AC2/Z → 34      BACK10 A/UX → 176  
SMART-IN10 AC2/Z → 88      UP-MINI10 A → 182  
OMNI10 AC2 → 136      SKIRT10 AC2/Q9 → 186

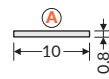

material / material / Material / matériel:

	PC	PP	PP
	transparent transparentny transparent transparent	frosted szron satiniert givré	opal mleczny opal opaque
1000 mm	89000616	89000639	89000638
2000 mm	89000716	89000739	89000738
3000 mm	-	89000839	-

**A1**

NEW

diffuser A1 slide  
klosz A1 wsuwany  
Abdeckung A1 einschiebbar  
diffuseur A1 coulissant

GROOVE10.v2 A1C/U → 94  
CORNER10.v2 A1C/U1 → 128  
GLOW12 UP A1C → 140  
GLOW12 DOWN A1C → 142

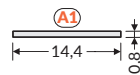

material / material / Material / matériel:

	PC	PP	PP
	transparent transparentny transparent transparent	frosted szron satiniert givré	opal mleczny opal opaque
1000 mm	J6000816	J6000839	J6000838
2000 mm	J6000916	J6000939	J6000938
3000 mm	-	J6001039	-

**A9**

diffuser A9 slide  
klosz A9 wsuwany  
Abdeckung A9 einschiebbar  
diffuseur A9 coulissant

VARIO30-01 ACDE-9/TY → 59  
VARIO30-02 ACDE-9/TY → 60  
VARIO30-03 ACDE-9/TY → 63  
COMBO30-01 ACDE-9 → 71  
VARIO30-06 ACDE-9/U9 → 111  
VARIO30-07 ACDE-9/U9 → 112  
VARIO30-04 ACDE-9 → 153  
VARIO30-05 ACDE-9 → 154

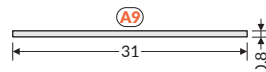

material / material / Material / matériel:

	PC	PP	PP
	transparent transparentny transparent transparent	frosted szron satiniert givré	opal mleczny opal opaque
1000 mm	V3000116	V3000139	V3000138
2000 mm	V3000216	V3000239	V3000238
3000 mm	-	V3000339	-

**B**

diffuser B slide  
klosz B wsuwany  
Abdeckung B einschiebbar  
diffuseur B coulissant

UNI12 BCD/U → 38  
SURFACE10 BC/UX → 40  
SURFACE10.v2 BC/U → 42  
SMART16 BC3/U4 → 48  
GROOVE10 BC/UX → 92  
GROOVE14.v2 BC3/Y → 98  
DEEP10 BC/UX → 102  
SMART-IN16 BC3/U4 → 104  
QUARTER10 BD/U6 → 120  
CORNER10 BC/UX → 126  
FRAME14 BC/Q → 144  
SMOOTH12 BC/Q9 → 146  
WALLE12 BCD → 180

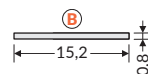

material / material / Material / matériel:

	PC	PP	PP
	transparent transparentny transparent transparent	frosted szron satiniert givré	opal mleczny opal opaque
1000 mm	76000116	76000139	76000138
2000 mm	76000216	76000239	76000238
3000 mm	-	76000339	-



diffuser C click  
klosz C klik  
Abdeckung C einclipsbar  
diffuseur C clic

BEGTON12 J/S → 36  
UNI12 BCD/U → 38  
SURFACE10 BC/UX → 40  
SURFACE10.v2 BC/U → 42  
GROOVE10 BC/UX → 92  
GROOVE10.v2 A1C/U → 94  
DEEP10 BC/UX → 102  
CORNER10 BC/UX → 126  
CORNER10.v2 A1C/U1 → 128  
GLOW12 UP A1C → 140  
GLOW12 DOWN A1C → 142

FRAME14 BC/Q → 144  
SMOOTH12 BC/Q9 → 146  
UNI-TILE12 C → 164  
ARC12 CD/U5 → 170  
PEN12 CJ → 174  
WAY10 C → 178  
WALLE12 BCD → 180

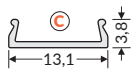

material / materiał / Material / matériel:

PMMA

PMMA

PMMA

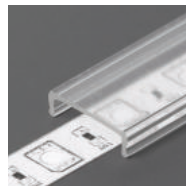

transparent  
transparentny  
transparent  
transparent

1000 mm  
2000 mm  
3000 mm  
4100 mm

76320000  
76330000  
76650000  
76660000



opal  
mleczny  
opal  
opaque

76320038  
76330038  
76650038  
76660038



black  
czarny  
schwarz  
noir

76320041  
76330041  
76650041  
76660041

scissors for cutting diffusers  
nożyce do cięcia kloszy  
Schere zum Schneiden  
von Abdeckungen  
ciseaux pour couper  
les diffuseurs



73046028

reel  
rolka  
Rolle  
rouleau

length:  
długość  
Länge:  
longeur:  
20 000 mm (20 m)

material / materiał / Material / matériel:

PMMA



NEW  
20 m

opal  
mleczny  
opal  
opaque

763600385



diffuser C click lens gen2  
klosz C klik soczewka gen2  
Abdeckung C einclipsbar Linse gen2  
diffuseur C clic lentille gen2

UNI12 BCD/U → 38  
SURFACE10 BC/UX → 40  
SURFACE10.v2 BC/U → 42  
GROOVE10 BC/UX → 92  
GROOVE10.v2 A1C/U → 94  
DEEP10 BC/UX → 102  
CORNER10 BC/UX → 126  
CORNER10.v2 A1C/U1 → 128

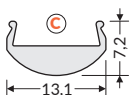

material / materiał / Material / matériel:

PC

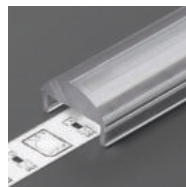

transparent  
transparentny  
transparent  
transparent

2000 mm

76810016



diffuser C1 click  
klosz C1 klik  
Abdeckung C1 einclipsbar  
diffuseur C1 clic

HI8 C1 → 86



material / materiał / Material / matériel:

PMMA



opal  
mleczny  
opal  
opaque

1000 mm  
2000 mm  
3000 mm  
4000 mm

H8050038  
H8060038  
H8070038  
H8080038



**C2**

diffuser C2 click  
klosz C2 klik  
Abdeckung C2 einclipsbar  
diffuseur C2 clic

SLIM8 AC2/Z → 32  
SMART10 AC2/Z → 34  
SMART-IN10 AC2/Z → 88  
OMNI10 AC2 → 136  
SKIRT10 AC2/Q9 → 186

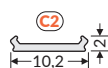

material / materiał / Material / matériel:

	PMMA	PMMA	PMMA
	transparent transparentny transparent transparent	opal mleczny opal opaque	black czarny schwarz noir
1000 mm	89000116	89000138	-
2000 mm	89000216	89000238	89000241
3000 mm	89000316	89000338	-
4100 mm	89000416	89000438	-

scissors for cutting diffusers  
nożyce do cięcia kloszy  
Schere zum Schneiden  
von Abdeckungen  
ciseaux pour couper  
les diffuseurs



reel  
rolka  
Rolle  
rouleau

length:  
długość  
Länge:  
longueur:  
20 000 mm (20 m)

73046028

material / materiał / Material / matériel:

	PMMA	PMMA
	opal mleczny opal opaque	black czarny schwarz noir
	89000538S	89000541S
	<b>NEW</b> 20 m	<b>NEW</b> 20 m

**C3**

diffuser C3 click  
klosz C3 klik  
Abdeckung C3 einclipsbar  
diffuseur C3 clic

SMART16 BC3/U4 → 48  
GROOVE14.v2 BC3/Y → 98  
SMART-IN16 BC3/U4 → 104



material / materiał / Material / matériel:

	PMMA	PMMA	PMMA
	transparent transparentny transparent transparent	opal mleczny opal opaque	black czarny schwarz noir
1000 mm	F1000116	F1000138	F1000141
2000 mm	F1000216	F1000238	F1000241
3000 mm	F1000316	F1000338	F1000341
4000 mm	F1000416	F1000438	F1000441

**C4**

diffuser C4 click  
klosz C4 klik  
Abdeckung C4 einclipsbar  
diffuseur C4 clic

COMBO30-03 C4/Q9 → 73  
HIDE10 C4 → 148

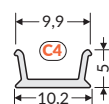

material / materiał / Material / matériel:

	PC
	opal mleczny opal opaque
1000 mm	H7000538
2000 mm	H7000638
3000 mm	H7000738
4000 mm	H7000838

**C9**

diffuser C9 click  
klosz C9 klik  
Abdeckung C9 einclipsbar  
diffuseur C9 clic

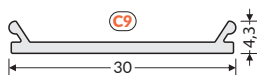

material / materiał / Material / matériel:

PMMA

PMMA

PMMA

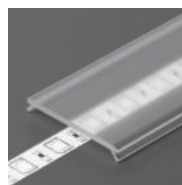

transparent  
transparentny  
transparent  
transparent

opal  
mleczny  
opal  
opaque

black  
czarny  
schwarz  
noir

1000 mm	V3450016
2000 mm	V3460016
3000 mm	V3470016
4100 mm	V3480016

V3450038
V3460038
V3470038
V3480038

V3450041
V3460041
V3470041
V3480041

**C10**<sup>1</sup>

diffuser C10 click OPAL  
klosz C10 klik OPAL  
Abdeckung C10 einclipsbar OPAL  
diffuseur C10 clic OPAL

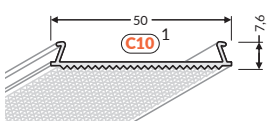

material / materiał / Material / matériel:

PMMA

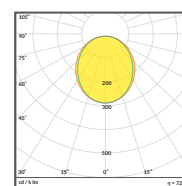
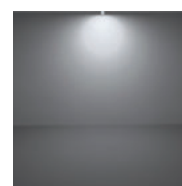
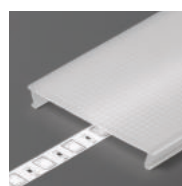

OPAL

LOWI C10 → 78  
PHIL53 C10 → 80  
PHIL  
RECESSED / WPUST / EINBAU / À ENCASTRER C10 → 116

1000 mm	63680038
2000 mm	63690038
3000 mm	63760038
4000 mm	63700038

**C10**<sup>2</sup>

diffuser C10 click NARROW  
klosz C10 klik NARROW  
Abdeckung C10 einclipsbar NARROW  
diffuseur C10 clic NARROW

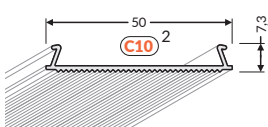

material / materiał / Material / matériel:

PC

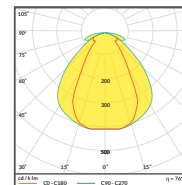
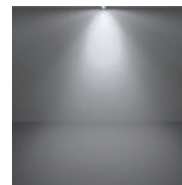
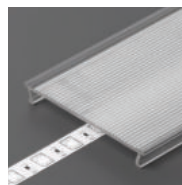

NARROW

LOWI C10 → 78  
PHIL53 C10 → 80  
PHIL  
RECESSED / WPUST / EINBAU / À ENCASTRER C10 → 116

1000 mm	63610038
2000 mm	63620000
3000 mm	63790000
4050 mm	63800000

**C10**<sup>3</sup>

diffuser C10 click WIDE  
klosz C10 klik WIDE  
Abdeckung C10 einclipsbar WIDE  
diffuseur C10 clic WIDE

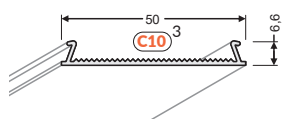

material / materiał / Material / matériel:

PC

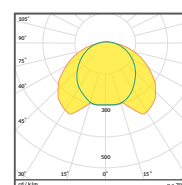
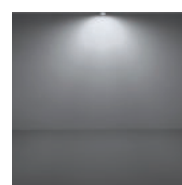
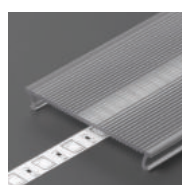

WIDE

LOWI C10 → 78  
PHIL53 C10 → 80  
PHIL  
RECESSED / WPUST / EINBAU / À ENCASTRER C10 → 116

1000 mm	63580000
2000 mm	63590000
3000 mm	63770000
4000 mm	63780000

**D**

diffuser D click  
klosz D klik  
Abdeckung D einclipsbar  
diffuseur D clic

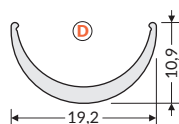

material / materiał / Material / matériel:

PMMA



opal  
mleczny  
opal  
opaque

1000 mm	A1130038
2000 mm	A1140038
3000 mm	A1150038
4100 mm	A1160038

UNI12 BCD/U → 38  
QUARTER10 BD/U6 → 120  
ARC12 CD/U5 → 170  
WALLE12 BCD → 180

**D9**

diffuser D9 click  
klosz D9 klik  
Abdeckung D9 einclipsbar  
diffuseur D9 clic

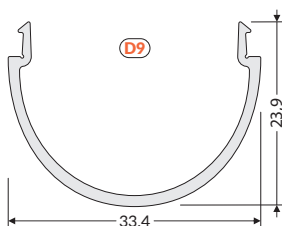

material / materiał / Material / matériel:

PMMA



opal  
mleczny  
opal  
opaque

1000 mm	V3490038
2000 mm	V3500038
3000 mm	V3510038
4000 mm	V3520038

VARIO30-01 ACDE-9/TY → 59  
VARIO30-02 ACDE-9/TY → 60  
VARIO30-03 ACDE-9/TY → 63  
COMBO30-01 ACDE-9 → 70  
NAMI23 CD-9 → 76  
VARIO30-06 ACDE-9/U9 → 111  
VARIO30-07 ACDE-9/U9 → 112  
VARIO30-04 ACDE-9 → 153  
VARIO30-05 ACDE-9 → 154

PMMA

end cap D9  
zaślepka D9  
Endkappe D9  
embout D9



opal  
mleczny  
opal  
opaque

V4980038

**E**

diffuser E slide  
klosz E wsuwany  
Abdeckung E einschiebbar  
diffuseur E coulissant

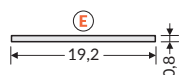

material / materiał / Material / matériel:

PC



transparent  
transparentny  
transparent  
transparent

1000 mm	A2000116
2000 mm	A2000216
3000 mm	-

SURFACE14 EE7F/TY → 44  
SURFACE14.v2 EE7F/Y → 46  
LINEA20 EE7F/TY → 50  
GROOVE14 EE7F/TY → 96  
LINEA-IN20 EE7F/U7 → 106  
CABI12 E → 122  
CABI12 DUO E → 124  
CORNER14 EE7F/TY → 130  
CORNER12.v2 EF/U → 132  
LINEA-IN20 TRIMLESS EE7F → 150

PP

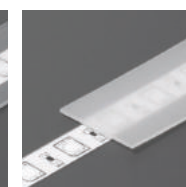

frosted  
szron  
satiniert  
givré

1000 mm	A2000139
2000 mm	A2000239
3000 mm	A2000339

PP

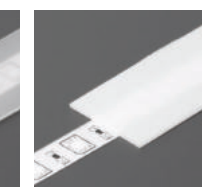

opal  
mleczny  
opal  
opaque

1000 mm	A2000138
2000 mm	A2000238
3000 mm	-

**E7**

diffuser E7 click  
klosz E7 klik  
Abdeckung E7 einclipsbar  
diffuseur E7 clic

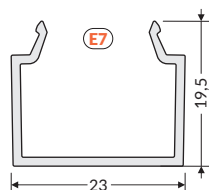

material / materiał / Material / matériel:

PMMA



opal  
mleczny  
opal  
opaque

1000 mm	C1070038
2000 mm	C1080038
3000 mm	C1090038
4050 mm	C1100038

SURFACE14 EE7F/TY → 44  
SURFACE14.v2 EE7F/Y → 46  
LINEA20 EE7F/TY → 50  
GROOVE14 EE7F/TY → 96  
LINEA-IN20 EE7F/U7 → 106  
CORNER14 EE7F/TY → 130  
LINEA-IN20 TRIMLESS EE7F → 150

PMMA

end cap E7  
zaślepka E7  
Endkappe E7  
embout E7



opal  
mleczny  
opal  
opaque

C1840038



**E9**

diffuser E9 click  
klosz E9 klik  
Abdeckung E9 einclipsbar  
diffuseur E9 clic

- VARIO30-01 ACDE-9/TY → 59
- VARIO30-02 ACDE-9/TY → 60
- VARIO30-03 ACDE-9/TY → 63
- COMBO30-01 ACDE-9 → 70
- NAMI23 CD-9 → 76
- VARIO30-06 ACDE-9/U9 → 111
- VARIO30-07 ACDE-9/U9 → 112
- VARIO30-04 ACDE-9 → 153
- VARIO30-05 ACDE-9 → 154

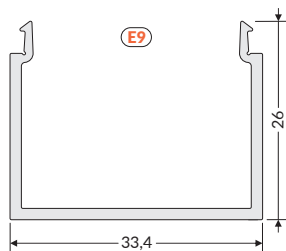

material / materiał / Material / matériel:  
PC



opal  
mleczny  
opal  
opaque

1000 mm	V3490038
2000 mm	V3500038
3000 mm	V3510038
4000 mm	V3520038

PMMA



opal  
mleczny  
opal  
opaque

V4980038

end cap E9  
zaślepka E9  
Endkappe E9  
embout E9

**F**

diffuser F click  
klosz F klik  
Abdeckung F einclipsbar  
diffuseur F clic

- SURFACE14 EE7F/TY → 44
- SURFACE14.v2 EE7F/Y → 46
- LINEA20 EE7F/TY → 50
- GROOVE14 EE7F/TY → 96
- DIAGONAL14 F/TY → 100
- LINEA-IN20 EE7F/U7 → 106
- CORNER14 EE7F/TY → 130
- CORNER12.v2 EF/U → 132
- LINEA-IN20 TRIMLESS EE7F → 150



material / materiał / Material / matériel:

PMMA

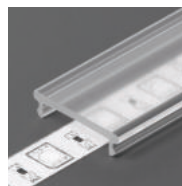

transparent  
transparentny  
transparent  
transparent

1000 mm	A2050016
2000 mm	A2060016
3000 mm	A2150016
4100 mm	A2160016

PMMA



opal  
mleczny  
opal  
opaque

1000 mm	A2050038
2000 mm	A2060038
3000 mm	A2150038
4100 mm	A2160038

PMMA



black  
czarny  
schwarz  
noir

1000 mm	A2050041
2000 mm	A2060041
3000 mm	A2150041
4100 mm	A2160041

material / materiał / Material / matériel:

PMMA

scissors for cutting diffusers  
nożyce do cięcia kloszy  
Schere zum Schneiden  
von Abdeckungen  
ciseaux pour couper  
les diffuseurs



reel  
rolka  
Rolle  
rouleau

length:  
długość  
Länge:  
longueur:  
20 000 mm (20 m)



opal  
mleczny  
opal  
opaque

A221003

NEW  
20 m

73046028

**G**

diffuser G slide  
klosz G wsuwany  
Abdeckung G einschiebbar  
diffuseur G coulissant



material / materiał / Material / matériel:

PC

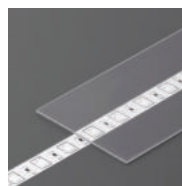

transparent  
transparentny  
transparent  
transparent

1000 mm	84000116
2000 mm	84000216
3000 mm	-

PP

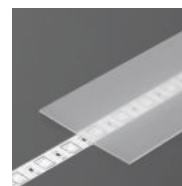

frosted  
szron  
satinert  
givré

1000 mm	84000139
2000 mm	84000239
3000 mm	84000339

PP

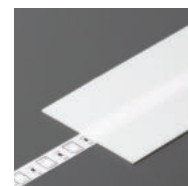

opal  
mleczny  
opal  
opaque

1000 mm	84000138
2000 mm	84000238
3000 mm	-

WIDE24 G/W → 56

**H**

diffuser H slide  
klosz H wsuwany  
Abdeckung H einschiebbar  
diffuseur H coulissant

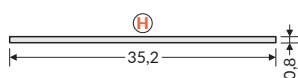

material / materiał / Material / matériel:

	PC	PP	PP
	transparent transparentny transparent transparent	frosted szron satiniert givré	opal mleczny opal opaque
1000 mm	<b>23000116</b>	<b>23000139</b>	<b>23000138</b>
2000 mm	<b>23000216</b>	<b>23000239</b>	<b>23000238</b>
3000 mm	-	<b>23000339</b>	-

FLAT8 H/UX → 114

**I**

diffuser I click  
klosz I klik  
Abdeckung I einclipsbar  
diffuseur I clic

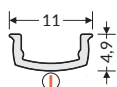

material / materiał / Material / matériel:

	PC	PC
	frosted szron satiniert givré	opal mleczny opal opaque
1000 mm	<b>86050000</b>	<b>86050038</b>
2000 mm	<b>86060000</b>	<b>86060038</b>
3000 mm	<b>86510000</b>	<b>86510038</b>
4100 mm	<b>86520000</b>	<b>86520038</b>

PEN8 I → 172

**J**

diffuser J slide  
klosz J wsuwany  
Abdeckung J einschiebbar  
diffuseur J coulissant

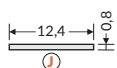

material / materiał / Material / matériel:

	PC	PP	PP
	transparent transparentny transparent transparent	frosted szron satiniert givré	opal mleczny opal opaque
1000 mm	<b>70000116</b>	<b>70000139</b>	<b>70000138</b>
2000 mm	<b>70000216</b>	<b>70000239</b>	<b>70999238</b>
3000 mm	-	<b>70000339</b>	-

BEGTON12 J/S → 36

BEGTIN12 J/S → 90

PEN12 CJ → 174

**K**

diffuser K click  
klosz K klik  
Abdeckung K einclipsbar  
diffuseur K clic

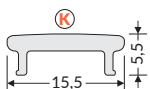

material / materiał / Material / matériel:

	PC
	opal mleczny opal opaque
1000 mm	<b>B1030038</b>
2000 mm	<b>B1040038</b>
3000 mm	<b>B1050038</b>
4100 mm	<b>B1060038</b>

FLOOR8 K → 158

FLOOR12 K/U → 160

UP-BOLD12 K → 184

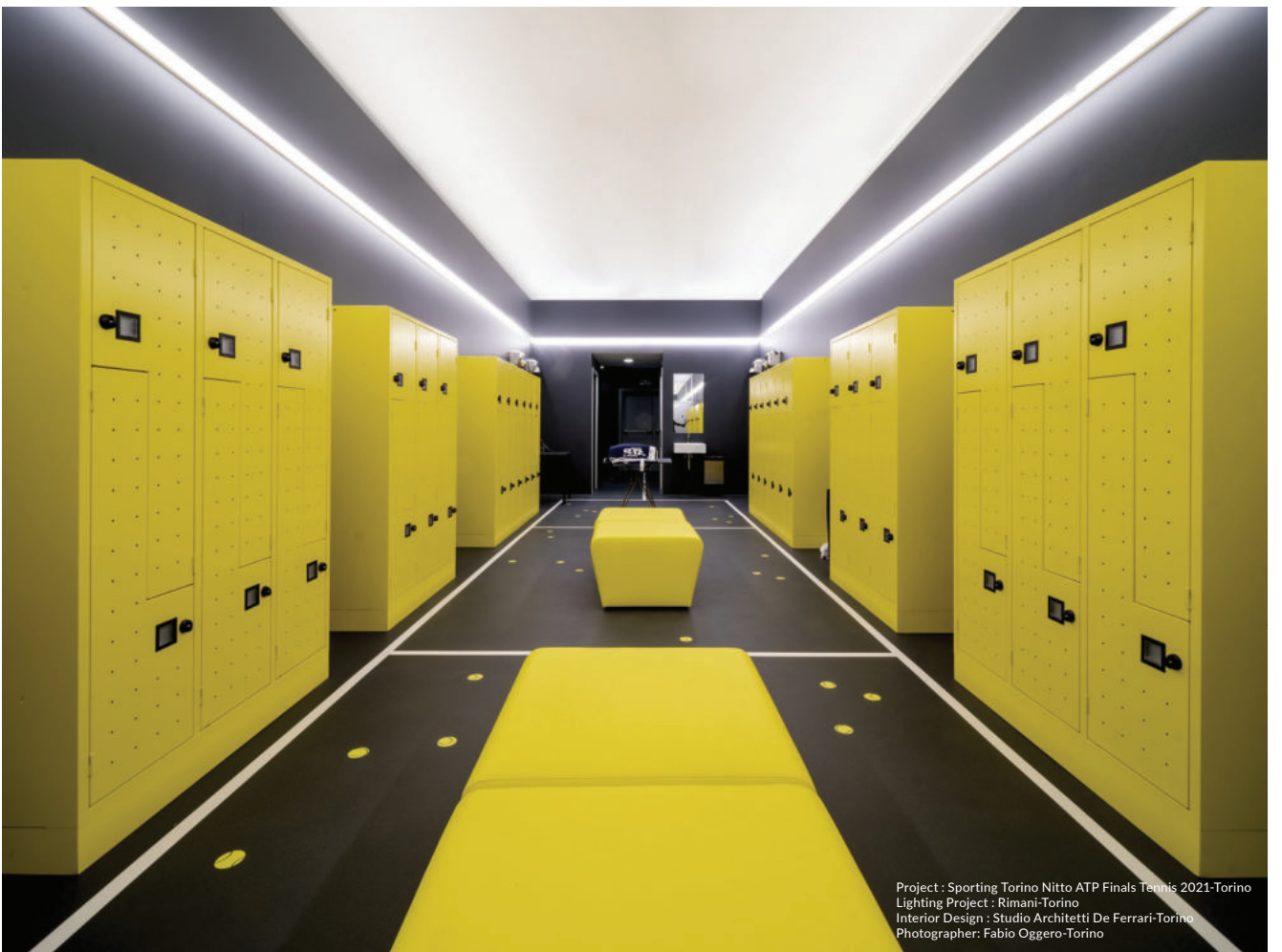

Project : Sporting Torino Nitto ATP Finals Tennis 2021-Torino  
Lighting Project : Rimani-Torino  
Interior Design : Studio Architetti De Ferrari-Torino  
Photographer: Fabio Oggero-Torino



# MOUNTINGS MOCOWANIA HALTER FIXATIONS

Q<sup>1</sup>

connector Q 90 deg bent  
łącznik Q 90 st gięty  
Verbinder Q 90 Grad gebogen  
connecteur Q 90 degrés plié

FRAME14 BC/Q → 144

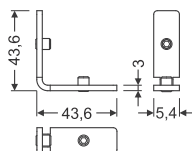

material: zinc coated steel  
materiał: stal ocynkowana  
Material: verzinkter Stahl  
matériau: acier galvanisé

C3960030

Q<sup>2</sup>

connector Q 180 deg  
łącznik Q 180 st  
Verbinder Q 180 Grad  
connecteur Q 80 degrés

FRAME14 BC/Q → 144

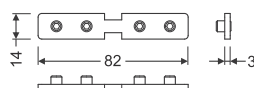

material: zinc coated steel  
materiał: stal ocynkowana  
Material: verzinkter Stahl  
matériau: acier galvanisé

C3990030

Q<sup>3</sup>

connector Q 135 deg  
łącznik Q 135 st  
Verbinder Q 135 Grad  
connecteur Q 135 degrés

FRAME14 BC/Q → 144

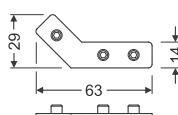

material: zinc coated steel  
materiał: stal ocynkowana  
Material: verzinkter Stahl  
matériau: acier galvanisé

C3980030

Q<sup>4</sup>

connector Q 90 deg  
łącznik Q 90 st  
Verbinder Q 90 Grad  
connecteur Q 90 degrés

FRAME14 BC/Q → 144

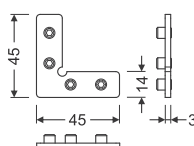

material: zinc coated steel  
materiał: stal ocynkowana  
Material: verzinkter Stahl  
matériau: acier galvanisé

C3970030

**Q9**<sup>1</sup>

connector Q9 90 deg bent  
 łącznik Q9 90 st gięty  
 Verbinder Q9 90 Grad gebogen  
 connecteur Q9 90 degrés pliable

COMBO30-02 **Q9** → 73  
 COMBO30-03 **C4/Q9** → 73  
 SMOOTH12 **BC/Q9** → 146  
 SKIRT10 **AC2/Q9** → 186

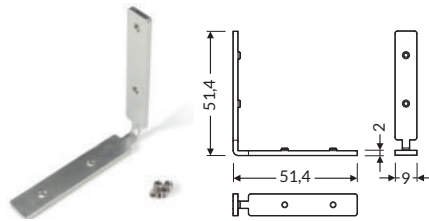

material: zinc coated steel  
 materiał: stal ocynkowana  
 Material: verzinkter Stahl  
 matériel: acier galvanisé

**V5999519S****Q9**<sup>2</sup>

connector Q9 180 deg  
 łącznik Q9 180 st  
 Verbinder Q9 180 Grad  
 connecteur Q9 180 degrés

COMBO30-02 **Q9** → 73  
 COMBO30-03 **C4/Q9** → 73  
 SMOOTH12 **BC/Q9** → 146  
 SKIRT10 **AC2/Q9** → 186

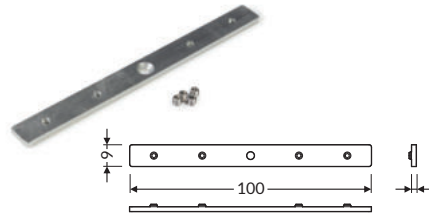

material: zinc coated steel  
 materiał: stal ocynkowana  
 Material: verzinkter Stahl  
 matériel: acier galvanisé

**V5999819S****Q9**<sup>3</sup>

connector Q9 135 deg  
 łącznik Q9 135 st  
 Verbinder Q9 135 Grad  
 connecteur Q9 135 degrés

COMBO30-02 **Q9** → 73  
 COMBO30-03 **C4/Q9** → 73  
 SMOOTH12 **BC/Q9** → 146  
 SKIRT10 **AC2/Q9** → 186

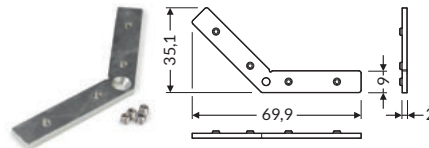

material: zinc coated steel  
 materiał: stal ocynkowana  
 Material: verzinkter Stahl  
 matériel: acier galvanisé

**V5999719S****Q9**<sup>4</sup>

connector Q9 120 deg  
 łącznik Q9 120 st  
 Verbinder Q9 120 Grad  
 connecteur Q9 120 degrés

COMBO30-02 **Q9** → 73  
 COMBO30-03 **C4/Q9** → 73  
 SMOOTH12 **BC/Q9** → 146  
 SKIRT10 **AC2/Q9** → 186

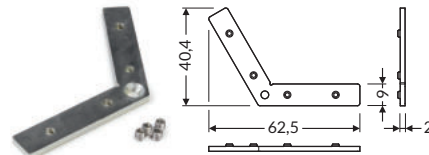

material: zinc coated steel  
 materiał: stal ocynkowana  
 Material: verzinkter Stahl  
 matériel: acier galvanisé

**V5999619S****Q9**<sup>5</sup>

connector Q9 90 deg  
 łącznik Q9 90 st  
 Verbinder Q9 90 Grad  
 connecteur Q9 90 degrés

COMBO30-02 **Q9** → 73  
 COMBO30-03 **C4/Q9** → 73  
 SMOOTH12 **BC/Q9** → 146  
 SKIRT10 **AC2/Q9** → 186

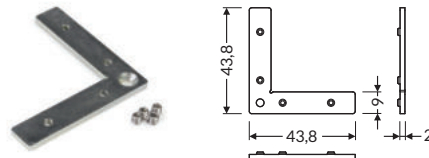

material: zinc coated steel  
 materiał: stal ocynkowana  
 Material: verzinkter Stahl  
 matériel: acier galvanisé

**V5999419S****Q9**<sup>6</sup>

connector Q9 60 deg  
 łącznik Q9 60 st  
 Verbinder Q9 60 Grad  
 connecteur Q9 60 degrés

COMBO30-02 **Q9** → 73  
 COMBO30-03 **C4/Q9** → 73  
 SMOOTH12 **BC/Q9** → 146  
 SKIRT10 **AC2/Q9** → 186

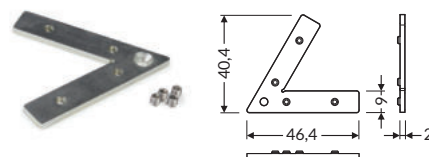

material: zinc coated steel  
 materiał: stal ocynkowana  
 Material: verzinkter Stahl  
 matériel: acier galvanisé

**V5999319S****Q9**<sup>7</sup>

connector Q9 45 deg  
 łącznik Q9 45 st  
 Verbinder Q9 45 Grad  
 connecteur Q9 45 degrés

COMBO30-02 **Q9** → 73  
 COMBO30-03 **C4/Q9** → 73  
 SMOOTH12 **BC/Q9** → 146  
 SKIRT10 **AC2/Q9** → 186

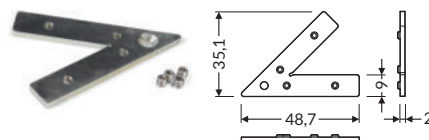

material: zinc coated steel  
 materiał: stal ocynkowana  
 Material: verzinkter Stahl  
 matériel: acier galvanisé

**V5999219S**

holder Q9 for sling  
 uchwyt Q9 do zawiesia  
 Halter Q9 für Abhängung  
 fixation Q9 pour suspension

material: zinc coated steel  
 materiał: stal ocynkowana  
 Material: verzinkter Stahl  
 matériel: acier galvanisé

**V5999919S**

screw for Q9 connector  
 wkręt do łącznika Q9  
 Schraube für Verbinder Q9  
 vis pour connecteur Q9

COMBO30-02 **Q9** → 73

**V5998830**

**S**<sup>1</sup>

mounting plate S  
uchwył S  
Halter S  
fixation S

BEGTON12 J/S → 36  
BEGTIN12 J/S → 90

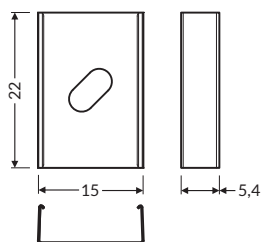

material: stainless steel  
materiał: stal nierdzewna  
Material: rostfreier Stahl  
matériau: acier inoxydable

white		black
biały		czarny
weiß		schwarz
blanc	inox	noir
C7980001	C7980019	C7980002

**S**<sup>2</sup>

mounting plate S cone  
uchwył S cone  
Halter S cone  
fixation S cône

BEGTON12 J/S → 36  
BEGTIN12 J/S → 90

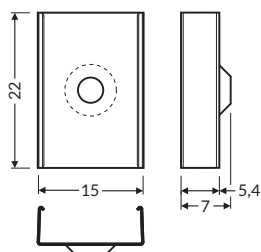
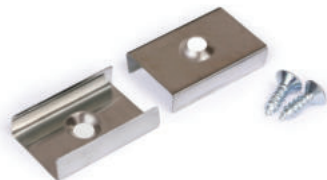

material: stainless steel  
materiał: stal nierdzewna  
Material: rostfreier Stahl  
matériau: acier inoxydable

white		black
biały		czarny
weiß		schwarz
blanc	inox	noir
C7950001	C7950019	C7950002

**T**<sup>1</sup>

mounting plate T  
uchwył T  
Halter T  
fixation T

SURFACE14 EE7F/TY → 44  
LINEA20 EE7F/TY → 50  
VARIO30-01 ACDE-9/TY → 59  
VARIO30-02 ACDE-9/TY → 60  
VARIO30-03 ACDE-9/TY → 63

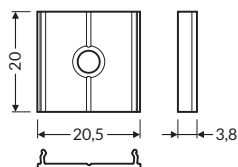

GROOVE14 EE7F/TY → 96  
DIAGONAL14 F/TY → 100  
CORNER14 EE7F/TY → 130

material: aluminium  
materiał: aluminium  
Material: Aluminium  
matériau: aluminium

raw aluminium  
surowe aluminium  
Rohaluminium  
aluminium brut  
C6960000

**T**<sup>2</sup>

connector T 180 deg  
łącznik T 180 st  
Verbinder T 180 Grad  
connecteur T 180 degrés

SURFACE14 EE7F/TY → 44  
LINEA20 EE7F/TY → 50  
VARIO30-01 ACDE-9/TY → 59  
VARIO30-02 ACDE-9/TY → 60  
VARIO30-03 ACDE-9/TY → 63

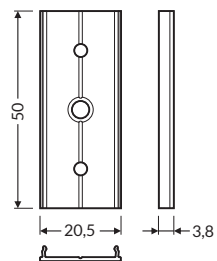

GROOVE14 EE7F/TY → 96  
DIAGONAL14 F/TY → 100  
CORNER14 EE7F/TY → 130

material: aluminium  
materiał: aluminium  
Material: Aluminium  
matériau: aluminium

raw aluminium  
surowe aluminium  
Rohaluminium  
aluminium brut  
C6990000

**U**<sup>1</sup>

mounting plate U  
uchwył U  
Halter U  
fixation U

UNI12 BCD/U → 38  
SURFACE10 BC/UX → 40  
SURFACE10.v2 BC/U → 42  
GROOVE10 BC/UX → 92  
GROOVE10.v2 A1C/U → 94

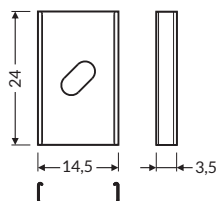

DEEP10 BC/UX → 102  
FLAT8 H/UX → 114  
CORNER10 BC/UX → 126  
CORNER12.v2 EF/U → 132  
FLOOR12 K/U → 160

BACK10 A/UX → 176

material: stainless steel  
materiał: stal nierdzewna  
Material: rostfreier Stahl  
matériau: acier inoxydable

inox  
76380000

**U**<sup>2</sup>

mounting plate U cone  
uchwył U cone  
Halter U cone  
fixation U cône

UNI12 BCD/U → 38  
SURFACE10 BC/UX → 40  
SURFACE10.v2 BC/U → 42  
GROOVE10 BC/UX → 92  
GROOVE10.v2 A1C/U → 94

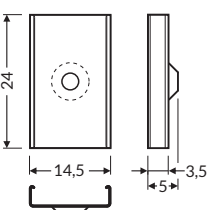

DEEP10 BC/UX → 102  
FLAT8 H/UX → 114  
CORNER10 BC/UX → 126  
CORNER12.v2 EF/U → 132  
FLOOR12 K/U → 160

BACK10 A/UX → 176

material: stainless steel  
materiał: stal nierdzewna  
Material: rostfreier Stahl  
matériau: acier inoxydable

inox  
76620000



**U1**<sup>1</sup>

mounting plate U1  
uchwyt U1  
Halter U1  
fixation U1

CORNER10.v2 A1C/U1 → 128

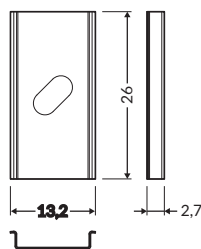

material: stainless steel  
materiał: stal nierdzewna  
Material: rostfreier Stahl  
matériel: acier inoxydable

inox  
A2090019

**U4**<sup>1</sup>

mounting plate U4  
uchwyt U4  
Halter U4  
fixation U4

SMART16 BC3/U4 → 48  
SMART-IN16 BC3/U4 → 104

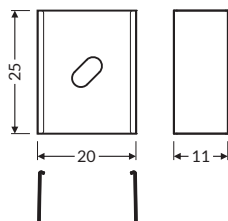

material: stainless steel  
materiał: stal nierdzewna  
Material: rostfreier Stahl  
matériel: acier inoxydable

white		black
biały		czarny
weiß		schwarz
blanc	inox	noir
<b>F1970001</b>	<b>F1970019</b>	<b>F1970002</b>

**U4**<sup>2</sup>

mounting plate U4 cone  
uchwyt U4 cone  
Halter U4 cone  
fixation U4 cône

SMART16 BC3/U4 → 48  
SMART-IN16 BC3/U4 → 104

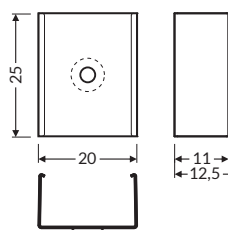

material: stainless steel  
materiał: stal nierdzewna  
Material: rostfreier Stahl  
matériel: acier inoxydable

white		black
biały		czarny
weiß		schwarz
blanc	inox	noir
<b>F1980001</b>	<b>F1980019</b>	<b>F1980002</b>

**U4**<sup>3</sup>

mounting plate U4 spring  
uchwyt U4 sprężyna  
Halter U4 Feder  
fixation U4 ressort

SMART-IN16 BC3/U4 → 104

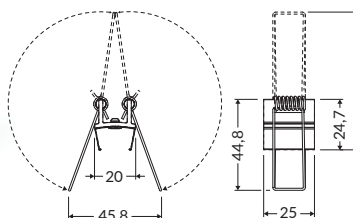

material: stainless steel, aluminium  
materiał: stal nierdzewna, aluminium  
Material: rostfreier Stahl, Aluminium  
matériel: acier inoxydable, aluminium

inox  
F6009819S

**U5**<sup>1</sup>

mounting plate U5 cone  
uchwyt U5 cone  
Halter U5 cone  
fixation U5 cône

ARC12 CD/U5 → 170

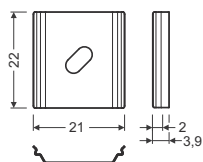

material: stainless steel  
materiał: stal nierdzewna  
Material: rostfreier Stahl  
matériel: acier inoxydable

inox  
B2940019

**U5**<sup>2</sup>

mounting plate U5 side  
uchwyt U5 boczny  
Halter U5 seitlich  
fixation U5 latérale

ARC12 CD/U5 → 170

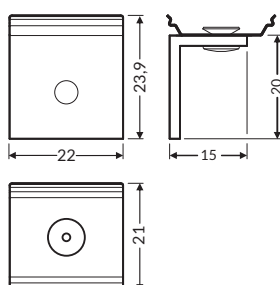

material: stainless steel  
materiał: stal nierdzewna  
Material: rostfreier Stahl  
matériel: acier inoxydable

white	raw aluminium	black
biały	surowe aluminium	czarny
weiß	Rohaluminium	schwarz
blanc	aluminium brut	noir
<b>B2920001</b>	<b>B2920000</b>	<b>B2920002</b>

**U6**<sup>1</sup>

mounting plate U6  
uchwyt U6  
Halter U6  
fixation U6

QUARTER10 BD/U6 → 120

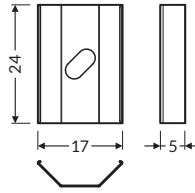

material: stainless steel  
materiał: stal nierdzewna  
Material: rostfreier Stahl  
matériel: acier inoxydable

inox  
D3960019

**U6**<sup>2</sup>

mounting plate U6 cone  
uchwyt U6 cone  
Halter U6 cone  
fixation U6 cône

QUARTER10 BD/U6 → 120

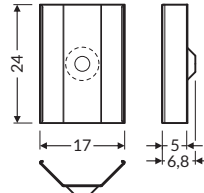

material: stainless steel  
materiał: stal nierdzewna  
Material: rostfreier Stahl  
matériel: acier inoxydable

inox  
D3970019

**U7**<sup>1</sup>

mounting plate U7  
uchwyt U7  
Halter U7  
fixation U7

LINEA-IN20 EE7F/U7 → 106

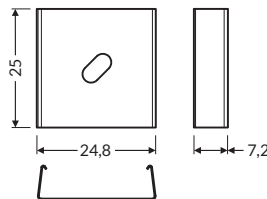

material: stainless steel  
materiał: stal nierdzewna  
Material: rostfreier Stahl  
matériel: acier inoxydable

inox  
E4960019

**U7**<sup>2</sup>

mounting plate U7 cone  
uchwyt U7 cone  
Halter U7 cone  
fixation U7 cône

LINEA-IN20 EE7F/U7 → 106

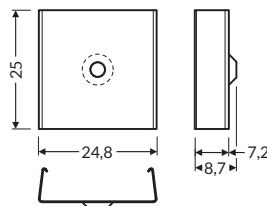

material: stainless steel  
materiał: stal nierdzewna  
Material: rostfreier Stahl  
matériel: acier inoxydable

inox  
E4970019

**U7**<sup>3</sup>

mounting plate U7 spring  
uchwyt U7 sprężyna  
Halter U7 Feder  
fixation U7 ressort

LINEA-IN20 EE7F/U7 → 106

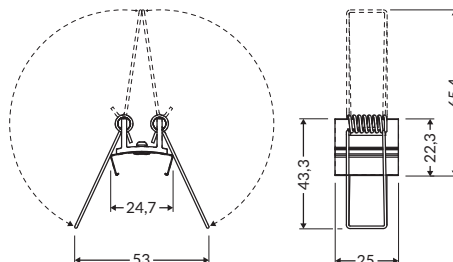

material: stainless steel  
materiał: stal nierdzewna  
Material: rostfreier Stahl  
matériel: acier inoxydable

inox  
E4880019S

**U9**<sup>1</sup>

mounting plate U9  
uchwyt U9  
Halter U9  
fixation U9

VARIO30-06 ACDE-9/U9 → 111  
VARIO30-07 ACDE-9/U9 → 112

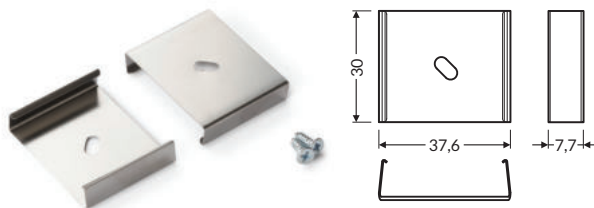

material: stainless steel  
materiał: stal nierdzewna  
Material: rostfreier Stahl  
matériel: acier inoxydable

inox  
**V4840019**

**U9**<sup>2</sup>

mounting plate U9 cone  
uchwyt U9 cone  
Halter U9 cone  
fixation U9 cône

VARIO30-06 ACDE-9/U9 → 111  
VARIO30-07 ACDE-9/U9 → 112

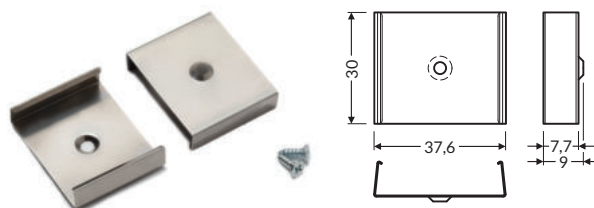

material: stainless steel  
materiał: stal nierdzewna  
Material: rostfreier Stahl  
matériel: acier inoxydable

inox  
**V4850019**

**U9**<sup>3</sup>

mounting plate U9 spring  
uchwyt U9 sprężyna  
Halter U9 Feder  
fixation U9 ressort

VARIO30-06 ACDE-9/U9 → 111  
VARIO30-07 ACDE-9/U9 → 112

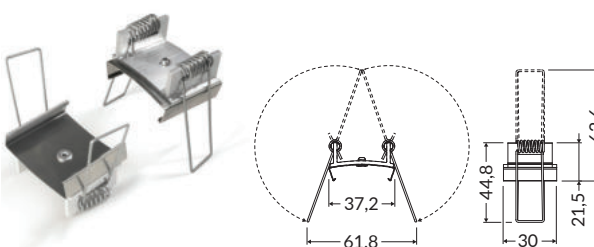

material: stainless steel  
materiał: stal nierdzewna  
Material: rostfreier Stahl  
matériel: acier inoxydable

inox  
**V4860019S**

**W**

mounting plate W cone  
uchwyt W cone  
Halter W cone  
fixation W cône

WIDE24 G/W → 56

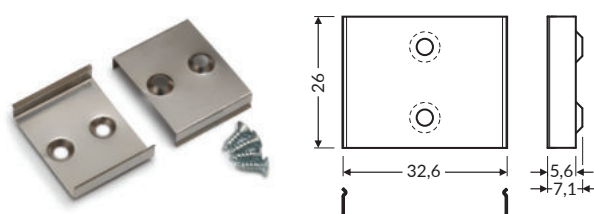

material: stainless steel  
materiał: stal nierdzewna  
Material: rostfreier Stahl  
matériel: acier inoxydable

white		black
biały		czarny
weiß		schwarz
blanc	inox	noir
<b>84510001</b>	<b>84510019</b>	<b>84510002</b>

**X**<sup>1</sup>

mounting plate X  
uchwyt X  
Halter X  
fixation X  
SURFACE10 BC/UX → 40  
GROOVE10 BC/UX → 92  
DEEP10 BC/UX → 102  
FLAT8 H/UX → 114  
CORNER10 BC/UX → 126  
BACK10 A/UX → 176

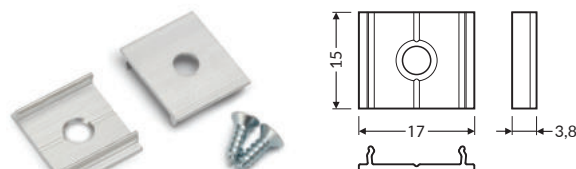

material: aluminium  
materiał: aluminium  
Material: Aluminium  
matériel: aluminium

raw aluminium  
surowe aluminium  
Rohaluminium  
aluminium brut  
**76260000**

**X**<sup>2</sup>

connector X 180 deg  
łącznik X 180 st  
Verbinder X 180 Grad  
connecteur X 180 degrés  
SURFACE10 BC/UX → 40  
GROOVE10 BC/UX → 92  
DEEP10 BC/UX → 102  
FLAT8 H/UX → 114  
CORNER10 BC/UX → 126  
BACK10 A/UX → 176

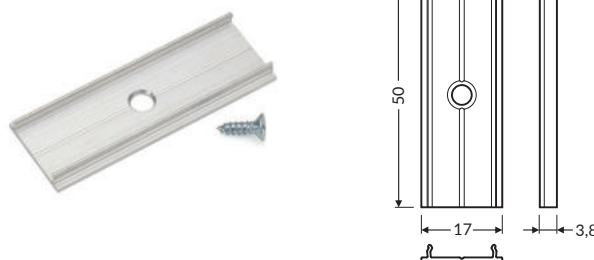

material: aluminium  
materiał: aluminium  
Material: Aluminium  
matériel: aluminium

raw aluminium  
surowe aluminium  
Rohaluminium  
aluminium brut  
**76350000**



**X**<sup>3</sup>

mounting plate X spring  
uchwyt X sprężyna  
Halter X Feder  
fixation X ressort

GROOVE10 BC/UX → 92  
DEEP10 BC/UX → 102  
FLAT8 H/UX → 114

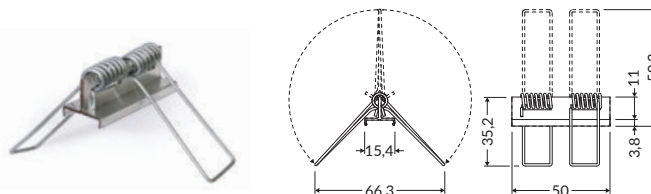

material: aluminium  
materiał: aluminium  
Material: Aluminium  
matériau: aluminium

raw aluminium  
surowe aluminium  
Rohaluminium  
aluminium brut  
**23130000**

**Y**<sup>1</sup>

mounting plate Y  
uchwyt Y  
Halter Y  
fixation Y

SURFACE14 EE7F/TY → 44  
SURFACE14.v2 EE7F/Y → 46  
LINEA20 EE7F/TY → 50  
VARIO30-01 ACDE-9/TY → 59  
VARIO30-02 ACDE-9/TY → 60  
VARIO30-03 ACDE-9/TY → 63



GROOVE14 EE7F/TY → 96  
GROOVE14.v2 EE7F/Y → 98  
DIAGONAL14 F/TY → 100  
CORNER14 EE7F/TY → 130

material: stainless steel  
materiał: stal nierdzewna  
Material: rostfreier Stahl  
matériau: inox

inox  
**A2090019**

**Y**<sup>2</sup>

mounting plate Y cone  
uchwyt Y cone  
Halter Y cone  
fixation Y cone /cône

SURFACE14 EE7F/TY → 44  
SURFACE14.v2 EE7F/Y → 46  
LINEA20 EE7F/TY → 50  
VARIO30-01 ACDE-9/TY → 59  
VARIO30-02 ACDE-9/TY → 60  
VARIO30-03 ACDE-9/TY → 63



GROOVE14 EE7F/TY → 96  
GROOVE14.v2 EE7F/Y → 98  
DIAGONAL14 F/TY → 100  
CORNER14 EE7F/TY → 130

material: stainless steel  
materiał: stal nierdzewna  
Material: rostfreier Stahl  
matériau: inox

inox  
**A2130019**

**Z**<sup>1</sup>

mounting plate Z  
uchwyt Z  
Halter Z  
fixation Z

SLIM8 AC2/Z → 32  
SMART10 AC2/Z → 34  
SMART-IN10 AC2/Z → 88



material: stainless steel  
materiał: stal nierdzewna  
Material: rostfreier Stahl  
matériau: acier inoxydable

white		black
biały		czarny
weiß		schwarz
blanc	inox	noir
<b>89270001</b>	<b>89270019</b>	<b>89270002</b>

**Z**<sup>2</sup>

mounting plate Z cone  
uchwyt Z cone  
Halter Z cone  
fixation Z cone/cône

SLIM8 AC2/Z → 32  
SMART10 AC2/Z → 34  
SMART-IN10 AC2/Z → 88



material: stainless steel  
materiał: stal nierdzewna  
Material: rostfreier Stahl  
matériau: inox

white		black
biały		czarny
weiß		schwarz
blanc	inox	noir
<b>89980001</b>	<b>89980019</b>	<b>89980002</b>

# LED PROFILE SLINGS ZAWIESIA DO PROFILI LED ABHÄNGUNGEN FÜR LED-PROFILE SUSPENSION POUR PROFILÉS LED

sling SELV  
zawiesz SELV  
Abhängung SELV  
suspension SELV  
50 V; 1500



1 kg per 1 set  
1 kg na 1 komplet  
1 kg für 1 Satz  
1 kg par 1 kit

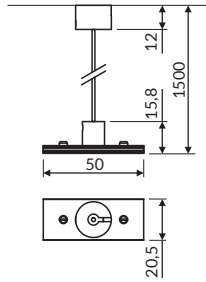

1500 mm	1500 mm	1500 mm
white	silver	black
biały	srebrny	czarny
weiß	silbern	schwarz
blanc	argent	noir
67120001	67120022	67120002

sling for mounting  
zawiesz do uchwytu  
Abhängung für den Halter  
suspension compatibles  
avec clips de fixation



10 kg per 1 set  
10 kg na 1 komplet  
10 kg für 1 Satz  
10 kg par 1 kit

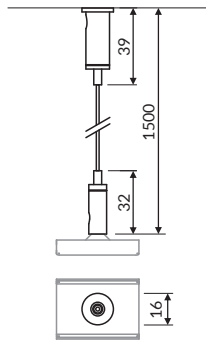

1500 mm
chrome
chrom
Chrom
chrom
67140003

sling large  
zawiesz duże  
Abhängung groß  
suspension grand



10 kg per 1 set  
10 kg na 1 komplet  
10 kg für 1 Satz  
10 kg par 1 kit

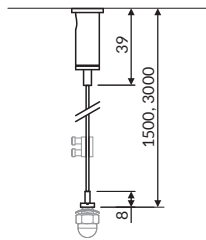

1500 mm	3000 mm
chrome	chrome
chrom	chrom
Chrom	Chrom
chrom	chrom
43100003	43110003

## SLINGS ZAWIESIA ABHÄNGUNG SUSPENSION

They enable creating pendant luminaires.  
They are especially recommended for  
the LED LINEA20, VARIO30-01, VARIO30-02,  
COMBO30, PHIL53 profile but are also compatible  
with most of the profiles.

Umożliwiają tworzenie opraw wiszących.  
Szczególnie polecane są do profilu LED LINEA20,  
VARIO30-01, VARIO30-02, COMBO30, PHIL53,  
ale kompatybilne są także z większością profili.

Sie ermöglichen den Bau von Hängeleuchten.  
Besonders empfohlen sind sie für das LED Profil  
LINEA20, VARIO30-01, VARIO30-02, COMBO30,  
PHIL53, aber sie sind auch mit der Mehrheit  
der Profile kompatibel.

Ils permettent la création de luminaires suspendus.  
Ils sont particulièrement recommandés pour le profilé  
LED LINEA20, VARIO30-01, VARIO30-02,  
COMBO30, PHIL53, mais ils sont également  
compatibles avec la plupart des profilés.

MAX  
50 V

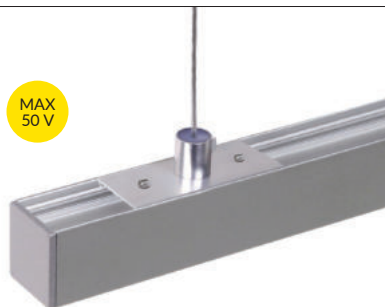

sling SELV 50 V 1500  
zawiesz SELV 50 V 1500  
Abhängung SELV 50 V 1500  
suspension SELV 50 V 1500



sling for mounting  
zawiesz do uchwytu  
Abhängung für den Halter  
suspension compatible  
avec clips de fixation



# VARIO30 LED ACCESSORIES

## AKCESORIA LED DO VARIO30

### VARIO30 LED ZUBEHÖR

#### ACCESSOIRES POUR PROFILÉS LED VARIO30

LED clamp VARIO30  
 docisk LED VARIO30  
 LED Klemme VARIO30  
 clip de fixation LED VARIO30

VARIO30-02 ACDE-9/TY → 60  
 VARIO30-03 ACDE-9/TY → 63  
 VARIO30-06 ACDE-9/TY → 111  
 VARIO30-07 ACDE-9/TY → 112  
 VARIO30-04 ACDE-9/TY → 153  
 VARIO30-05 ACDE-9/TY → 154

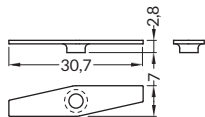

material: steel, plastic  
 materiał: stal, tworzywo  
 Material: Stahl, Kunststoff  
 matériel: acier, plastique

white painted  
 biały malowany  
 weiß lackiert  
 peint en blanc

**V4630001**

LED clamp VARIO30-1  
 docisk LED VARIO30-1  
 LED Klemme VARIO30-1  
 clip de fixation LED VARIO30 1

VARIO30-02 ACDE-9/TY → 60  
 VARIO30-03 ACDE-9/TY → 63  
 VARIO30-07 ACDE-9/TY → 112  
 VARIO30-05 ACDE-9/TY → 154

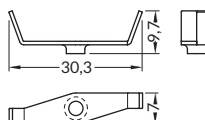

material: steel, plastic  
 materiał: stal, tworzywo  
 Material: Stahl, Kunststoff  
 matériel: acier, plastique

white painted  
 biały malowany  
 weiß lackiert  
 peint en blanc

**V4520001**

LED mounting VARIO30  
 mocowanie LED VARIO30  
 LED Montageteil VARIO30  
 fixation LED VARIO30

VARIO30-02 ACDE-9/TY → 60  
 VARIO30-03 ACDE-9/TY → 63  
 VARIO30-07 ACDE-9/TY → 112  
 VARIO30-05 ACDE-9/TY → 154

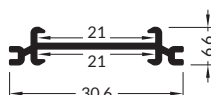

raw aluminium  
 surowe aluminium  
 Rohaluminium  
 aluminium brut

1000 mm	<b>V3570000</b>
2000 mm	<b>V3580000</b>
3000 mm	<b>V3590000</b>
4050 mm	<b>V3600000</b>



# OTHER ACCESSORIES POZOSTAŁE AKCESORIA SONSTIGES ZUBEHÖR AUTRES ACCESSOIRES

adhesive tape double-sided  
thermally conductive 15 mm x 50 mm  
taśma dwustronna  
termoprzewodząca 15 mm x 50 m  
doppelseitiges  
wärmeleitendes Band 15 mm x 50 mm  
ruban adhésif double face  
thermiqument conducteur 15 mm x 50 m

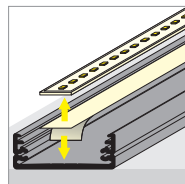

1 reel  
1 rolka  
1 Rolle  
1 rouleau  
67990000

adhesive tape double-sided  
nonconductive 25 x 25 mm  
taśma dwustronna  
nieprzewodząca 25 x 25 mm  
nicht leitendes  
doppelseitiges Band 25 x 25 mm  
ruban adhésif double face  
non-conducteur 25 x 25 mm

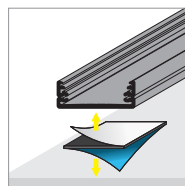
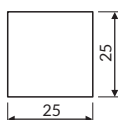

76340000

adhesive tape double-sided mounting  
HPX 12mm x 5m  
taśma dwustronna montażowa  
HPX 12 mm x 5 m  
doppelseitiges Montageband  
HPX 12 mm x 5 m  
ruban adhésif double face  
HPX 12 mm x 5 m

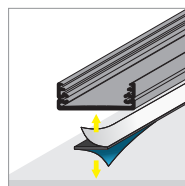

67960000

magnetic holder  
M02 6 x 20 x 2 mm  
uchwyt magnetyczny  
M02 6 x 20 x 2 mm  
Magnethalter  
M02 6 x 20 x 2 mm  
clip de fixation magnétique  
M02 6 x 20 x 2 mm

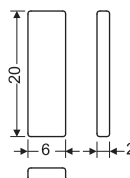

67260000

magnetic holder  
M01 10 x 14 x 1,5 mm  
uchwyt magnetyczny  
M01 10 x 14 x 1,5 mm  
Magnethalter  
M01 10 x 14 x 1,5 mm  
clip de fixation magnétique  
M01 10 x 14 x 1,5 mm

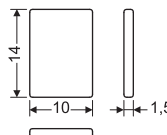

67250000

cleaning rubber  
for anodized surfaces  
gumka do czyszczenia  
powierzchni anodowanych  
Radiergummi für die Reinigung  
eloxierter Oberflächen  
gomme pour le nettoyage  
des surfaces anodisées



25250000

# SALES SUPPORT WSPARCIE SPRZEDAŻY VERTRIEBSUNTERSTÜTZUNG LE SOUTIEN AUX VENTES

TOPMET Light's e-showroom.  
Wirtualny showroom TOPMET Light.  
Virtueller TOPMET Light Raum.  
Showroom virtuel TOPMET Light.



Get inspired by new products in TOPMET Light's e-showroom.  
Zainspiruj się nowymi produktami w wirtualnym salonie TOPMET Light.  
Lassen Sie sich von neuen Produkten im virtuellen Raum von TOPMET Light inspirieren.  
Laissez-vous inspirer par les nouveaux produits dans le showroom virtuelle TOPMET Light

TOPMET Light's 360° Virtual Showroom  
Wirtualny Showroom 360° TOPMET Light znajdziesz tu  
ier finden Sie den 360° virtuellen Raum von TOPMET  
Vous trouverez ici le showroom virtuel à 360° de TOPMET

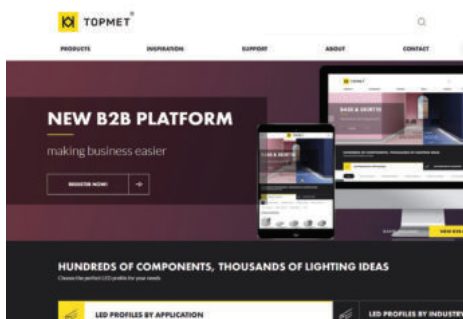

Immerse yourself into TOPMET's website  
Zanurz się w przestrzeni strony TOPMET  
Tauchen Sie ein in die TOPMET-Website  
Découvrez les possibilités offertes par le site TOPMET

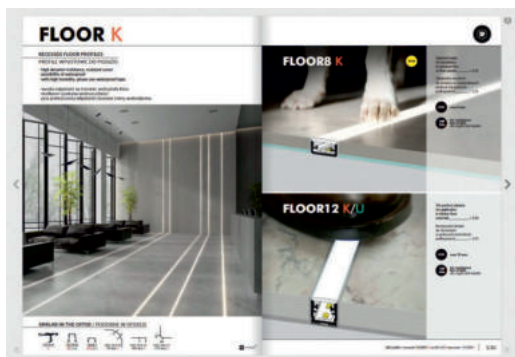

Find all informations about TOPMET's products in our e-catalogue  
Znajdź wszystkie informacje o produktach TOPMET  
w naszym e-katalogu  
Alle Informationen über TOPMET-Produkte finden Sie  
in unserem e-Katalog  
Retrouvez toutes les informations sur les produits TOPMET

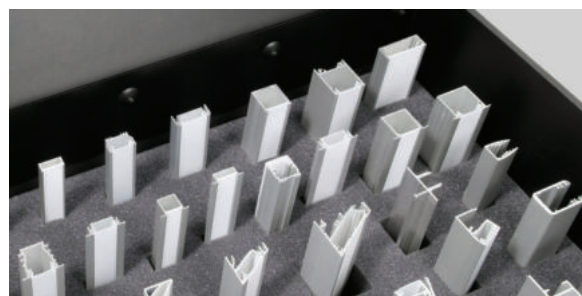

THREE TYPES OF LED PROFILES SAMPLE CASES  
TRZY RODZAJE WALIZEK Z PRÓBKAMI PROFILI LED  
DREI TYPEN VON KOFFERN MIT LED-PROFILPROBEN  
TROIS TYPES DES MALLETTES DE PRESENTATION

FURNITURE	ARCHITECTURAL	LIGHTING
MEBLOWE	ARCHITEKTONICZNE	OŚWIETLENIOWE
MÖBEL-	ARCHITEKTONISCH	BELEUCHTUNGS-
MEUBLES	ARCHITECTURE	ÉCLAIRAGE

ACCESSORIES FOR LED SYSTEM - MOUNTINGS  
 SYSTEMOWE AKCESORIA LED - MOCOWANIA  
 ZUBEHÖR FÜR LED-SYSTEME - HALTER  
 ACCESSOIRES POUR SYSTEMES LED - FIXATIONS

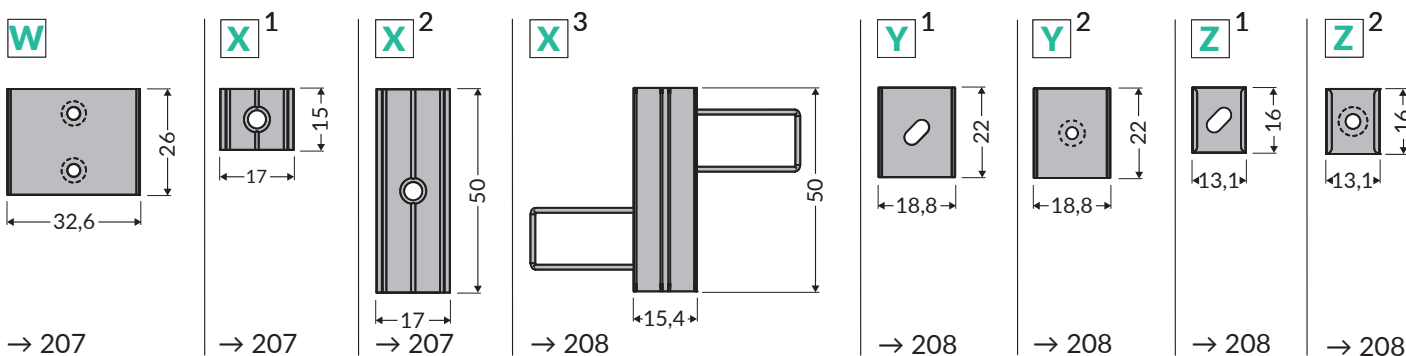
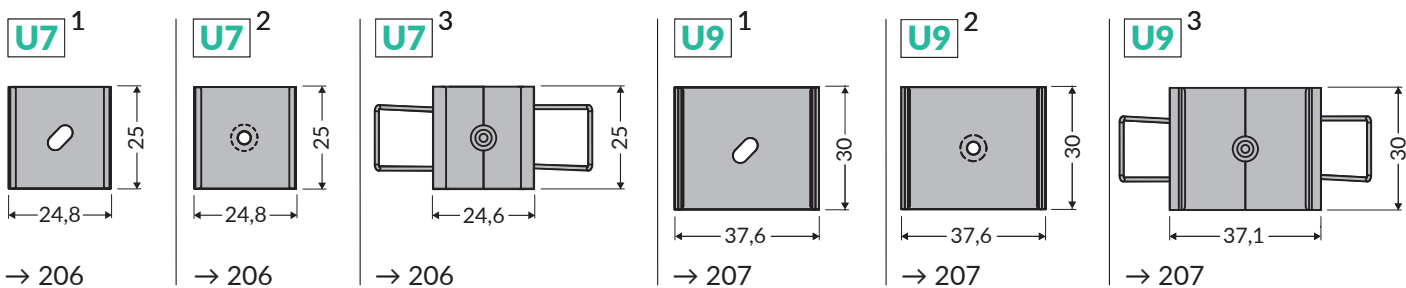
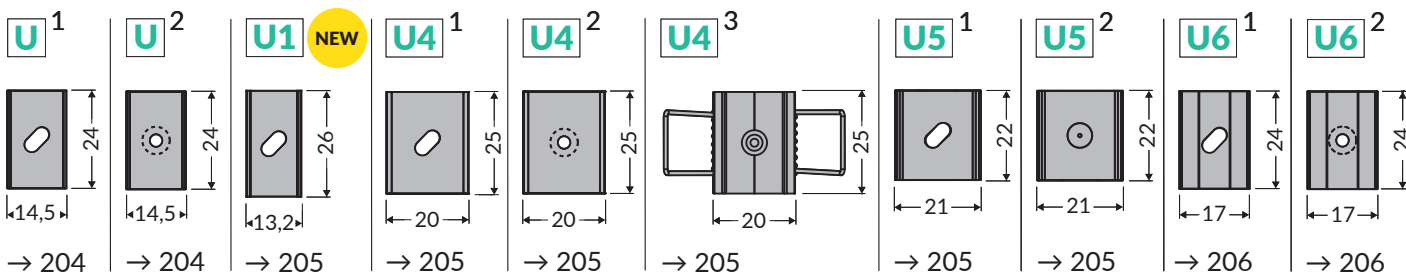
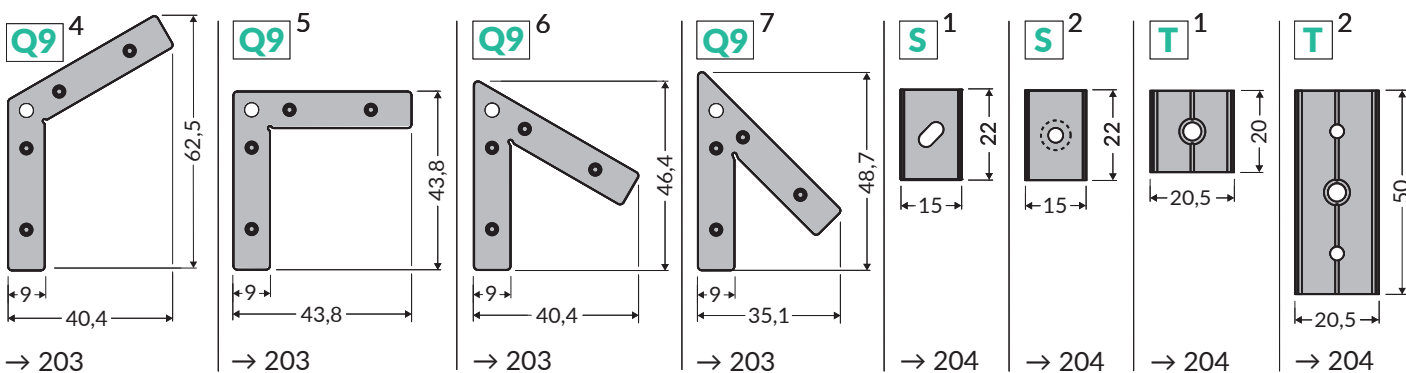
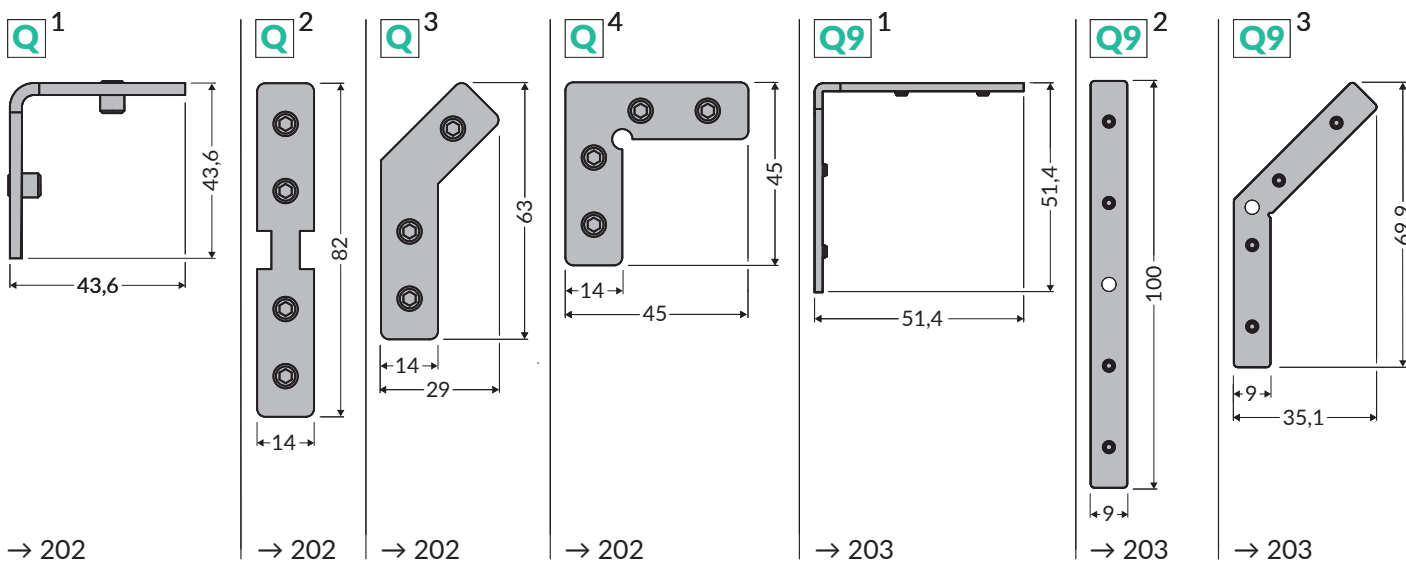





Made in Poland  
Wyprodukowane w Polsce  
In Polen hergestellt  
Fabriqué en Pologne



EU-registered industrial design  
Wzory przemysłowe EU  
EU Industriemuster  
Modèles industriels de l'UE

## TOPMET Light Kłósowicz Wiśniewski sp. z o.o.

HEADQUARTERS | SIEDZIBA GŁÓWNA  
HAUPTSITZ | SIĘGE SOCIAL  
**Ostrowska 354**  
**61-312 Poznań, POLAND**

FACTORY & WAREHOUSE | PRODUKCJA I MAGAZYN  
PRODUKTION UND LAGER | PRODUCTION ET ENTREPOT  
**Ostrowska 532A**  
**61-324 Poznań, POLAND**

RECEPTION OFFICE | SEKRETARIAT  
SEKRETARIAT | SEKRÉTARIAT  
**info@topmet.pl**  
**+48 61 872 75 00**  
**+48 698 610 944**

CUSTOMER SERVICE | BIURO OBSŁUGI KLIENTA  
KUNDENAUFTRAGSZENTRUM | SERVICE CLIENT  
**orders@topmet.pl**  
**+48 880 345 292**  
**+48 607 190 334**  
**+48 607 205 107**  
**+48 538 246 716**

The catalogue is not an offer under Polish Civil Code regulations. Colours of particular products may vary slightly from colours shown in pictures. The dimensions given are approximate and can not be a reason for complaint. TOPMET Company reserves the right to make technical changes.

Katalog nie stanowi oferty w myśl przepisów Kodeksu Cywilnego. Aktualną ofertę firmy stanowi cennik. Kolory poszczególnych produktów mogą się nieznacznie różnić od kolorów prezentowanych na zdjęciach. Podane wymiary są wymiarami orientacyjnymi i nie mogą stanowić podstawy reklamacji. Firma TOPMET zastrzega sobie prawo do wprowadzania zmian technicznych.

Der Katalog bildet kein Angebot im Sinne der Vorschriften des Zivilgesetzbuches. Das aktuelle Angebot bildet die Preisliste. Die Farben der jeweiligen Produkten können sich leicht von den auf den Bildern dargestellten Farben unterscheiden. Die angegebenen Abmessungen sind nur Orientierungsabmessungen und bilden keine Grundlage für eine Reklamation. Das Unternehmen TOPMET behält sich das Recht zur Einführung von technischen Änderungen vor.

Le catalogue ne constitue pas une offre au sens des dispositions du Code civil. La liste de prix constitue l'offre actuelle de l'entreprise. Les couleurs des produits individuels peuvent légèrement différer des couleurs présentées sur les photos. Les dimensions fournies sont approximatives et ne peuvent constituer la base d'une réclamation. TOPMET se réserve le droit d'apporter des modifications techniques.

catalogue designer • projekt folderu • Katalogdesigner • conception de dossier: M. Kędziora 08.2022.  
photo • fotografia • fotografie • photo: A. Szafran, S. Wawrzyn, L. Wesółowski, B. Bieliński.  
visualisations • wizualizacje • Visualisierungen • visualisations: M. Kędziora, A. Szafran, P. Woś, B. Bieliński



[www.topmet.pl](http://www.topmet.pl)

Distributor / Instrybutor / Distributor / Distributeur



5 901597 258704 >