

# mAntra

TÉCNICO

MANTRA EN EL MUNDO

MANTRA AROUND THE WORLD





David Villalba

EN

Mantra works with a very diverse team of freelance designers, specialized in different branches of design.

They are a group of highly qualified professionals experience in the lighting sector, who contribute with original solutions in the development of new concepts; they also participate actively in the whole product development process, from the initial draft to the lasted finishing details

This wide variety of styles that our designers offer have a direct impact on our catalogues, which are made up of ideas that are adapted to any type of lighting need.

Besides, we take pride in having a great relationship with them, which goes beyond the professional link. We truly rely on their capability and work methods, which have provided, such innovative and stylish collections so far.



Carlos Santolaria



José Ignacio Ballester

FR

Mantra collabore avec une équipe de dessinateurs externes très diverse, spécialisés dans différentes branches dans le monde du design.

Des professionnels avec une grande expérience dans le secteur de l'éclairage, qui apportent des solutions innovatrices au développement de nouveaux concepts, et participent dans tous les processus de fabrication du produit, depuis le brouillon jusqu'à la conception du produit final.

Cette grande variété de styles influence directement notre catalogue, qui est composé de solutions qui s'adaptent à tous les styles ou besoins dans le monde de l'éclairage.

Notre relation avec l'équipe de designers va plus loin que le contact professionnel, nous avons confiance sur leur savoir-faire, et leur méthodes de travail qui nous apporte fraîcheur et innovation, pour chacune de nos collections.

JW design



Wilfried Buelacher



Jackie Luo



Santiago Sevillano

ITL

Mantra collabora con un team di designer esterni molto diversi, specializzati in varie branche nel mondo del design.

Professionisti con esperienza nel settore dell'illuminazione che forniscono soluzioni innovative nello sviluppo di nuovi concetti, partecipando a tutti i processi di sviluppo del prodotto, dallo schizzo iniziale alla concezione del prodotto finale.

Questa ampia varietà di stili che ci offre influisce direttamente sul nostro catalogo, che è composto da soluzioni che si adattano a qualsiasi tipo di stile o esigenza nel mondo dell'illuminazione.

Il nostro trattamento con i designer va oltre un semplice trattamento professionale, confidiamo pienamente nel loro buon lavoro e nei loro metodi di lavoro che ci danno freschezza e innovazione in ciascuna delle nostre collezioni.



Hugo Tejada

ESP

Mantra colabora con un equipo de diseñadores externos muy diverso, especializados en diversas ramas dentro del mundo del diseño.

Profesionales con experiencia en el sector de la iluminación que aportan soluciones novedosas en el desarrollo de nuevos conceptos, participando en todos los procesos de desarrollo del producto, desde el boceto inicial hasta la concepción del producto final.

Esta gran variedad de estilos que nos ofrecen incide directamente en nuestro catálogo, el cual está compuesto por soluciones que se adaptan a cualquier tipo de estilo o necesidad dentro del mundo de la iluminación.

Nuestro trato con los diseñadores va más allá de un mero trato profesional, confiamos plenamente en su buen hacer y en sus métodos de trabajo que nos aporta frescura e innovación en cada una de nuestras colecciones.

# INTERIOR/INDOOR

## Aplique/Wall light

New



ALTEA 20	ASIMETRIC 56	BOAVISTA 78	BORA BORA 88	BORACAY 198	CABARETE 76	CAICOS 86
-------------	-----------------	----------------	-----------------	----------------	----------------	--------------

New

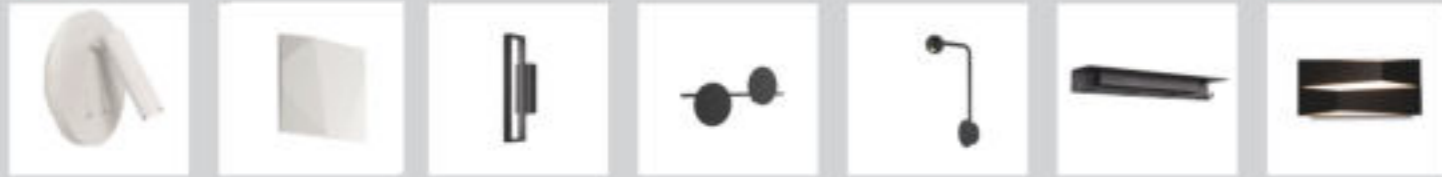

New

CAYMAN 74	COOK 110	DURBAN 50	ERS 42	EYES 36	FUERTEVENTURA 64	FUJI 14
--------------	-------------	--------------	-----------	------------	---------------------	------------



GOA 34	GOCOVA 80	HANOK 24	IOS 184	JER 102	KUBICK 30	LANZAROTE 106
-----------	--------------	-------------	------------	------------	--------------	------------------

New

New



LUPPI 28	MORNE 54	MURAL 94	ORION 16	PARACURU 100	PETACA 108	POLAR 48
-------------	-------------	-------------	-------------	-----------------	---------------	-------------

New



PREA 84	SAL 70	TAHITI 96	TAHITI XL 18	TARIFA 82	TENERFE 104
------------	-----------	--------------	-----------------	--------------	----------------

# INTERIOR/INDOOR

## Aplique/Wall light

New



TOBAGO 22	TOJA 98	TORCH 66	VENUS 38	VENUS 40	ZANZIBAR 58
--------------	------------	-------------	-------------	-------------	----------------

New

## Plafón/Ceiling

New

New



BORA BORA 88	HANOK 112	KUBICK 30	MURAL 118	SAL 114	SAONA SUPERFICIE 122	TORCH 116
-----------------	--------------	--------------	--------------	------------	-------------------------	--------------



ZERO E27  
120

## Colgante/Pendant

New

New

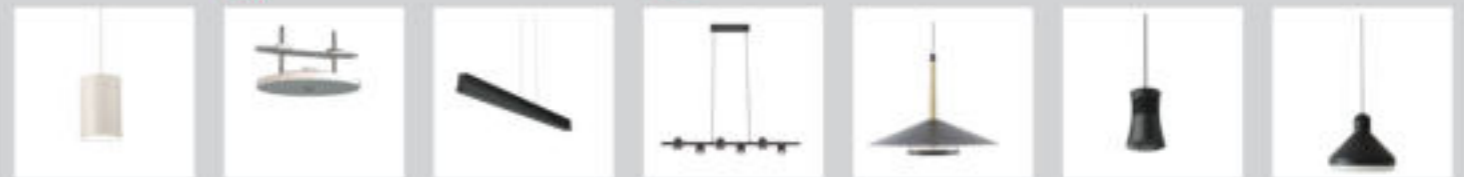

ARUBA 160	BASE COLGANTES 162	HANOK 128	IOS 126	ORION 140	PAGODA 136	SRIO 150
--------------	-----------------------	--------------	------------	--------------	---------------	-------------



TORCH  
158

## INTERIOR/INDOOR

### Sobremesa/Table lamp



EYES 166	MURAL 170	SAL 164	TORCH 168	ZANZIBAR 172
-------------	--------------	------------	--------------	-----------------

### Pie de salón/Floor lamp



EYES 176	MURAL 180	SAL 174	TORCH 178
-------------	--------------	------------	--------------

### Foco Superficie/Spotlight



ARUBA 190	BORACAY 198	COLUMBRETES 194	GLACIAR 182	GOWER 188	IOS 184	KALLUA 196
--------------	----------------	--------------------	----------------	--------------	------------	---------------



SAL  
186

## INTERIOR/INDOOR

### Foco carril trifásico/Triphasic rail spot



ARUBA 208	CARRILES-TRACKS 218	FUJI 212	EPSILON 200	PAGODA 204	SAL 210
--------------	------------------------	-------------	----------------	---------------	------------

### Empotrable/Recessed



ATLANTIS 258	BÁSICO GU10 244	BRANDON 250	CABRERA 234	CIES 256	COMFORT II 269	COMFORT GU10 248
-----------------	--------------------	----------------	----------------	-------------	-------------------	---------------------

New



FORMENTERA 230	GARDA 226	GUNCHO 222	GUNCHO GU10 224	GRACIOSA 242	LAMBORINI 259	MEDANO 236
-------------------	--------------	---------------	--------------------	-----------------	------------------	---------------

New



METACRILATO 254	NEPTUNO 228	SAONA 238
--------------------	----------------	--------------

### Campanas Led/Ufo bays Led



CAMPANAS 284	CAMPANAS 288
-----------------	-----------------

































### Tras Led/Strip Leds



DRIVERS 275	PERFILES 264	SISTEMAS 278	TRAS LED 260
----------------	-----------------	-----------------	-----------------

## EXTERIOR/OUTDOOR

### Aplique/Wall light

						
ALPINE 346	ANDES 292	ARC5 298	BERET 297	BORA 336	CHAMONIX 348	CERLER 357
						
CYCLE 300	DAVOS 324	DAVOS XL 328	DAVOS DOUBLE 330	EVEREST 322	IGUAZÚ 316	JACKSON 354
						
KANDANCHU 320	LEVI 352	LOTUS 294	MAYA 304	MERBEL 308	MERBEL 340	POLINESIA 302
						
RODAS 356	RUKA 306	SOCHI 334	SOLDEN 344	TACOS 350	TEJA 312	TIGNES 357
						
TRAX 332	UTAH 338	VERBER 364	VOLCANO 314	YETI 342		

## EXTERIOR/OUTDOOR

### Plafón exterior/Ceiling outdoor

						
BACHELOR 368	CHAMONIX 366	KANDANCHU 358	LEVI 370	MAYA 362	VERBER 364	VOLCANO 360

### Colgantes exterior/Pendant outdoor

			
AVDRAZ 384	KINKE 376	MAYA 382	POLINESIA 372

## EXTERIOR/OUTDOOR

### Sobremesa exterior portátil/Portable outdoor table lamp



### Lámpara de suelo exterior portátil/Portable outdoor floor lamp



### Sobremuro exterior/Over wall lamp



## EXTERIOR/OUTDOOR

### Balizas-Piquetas-Lámparas de suelo/Bollards-spike-ground lamps

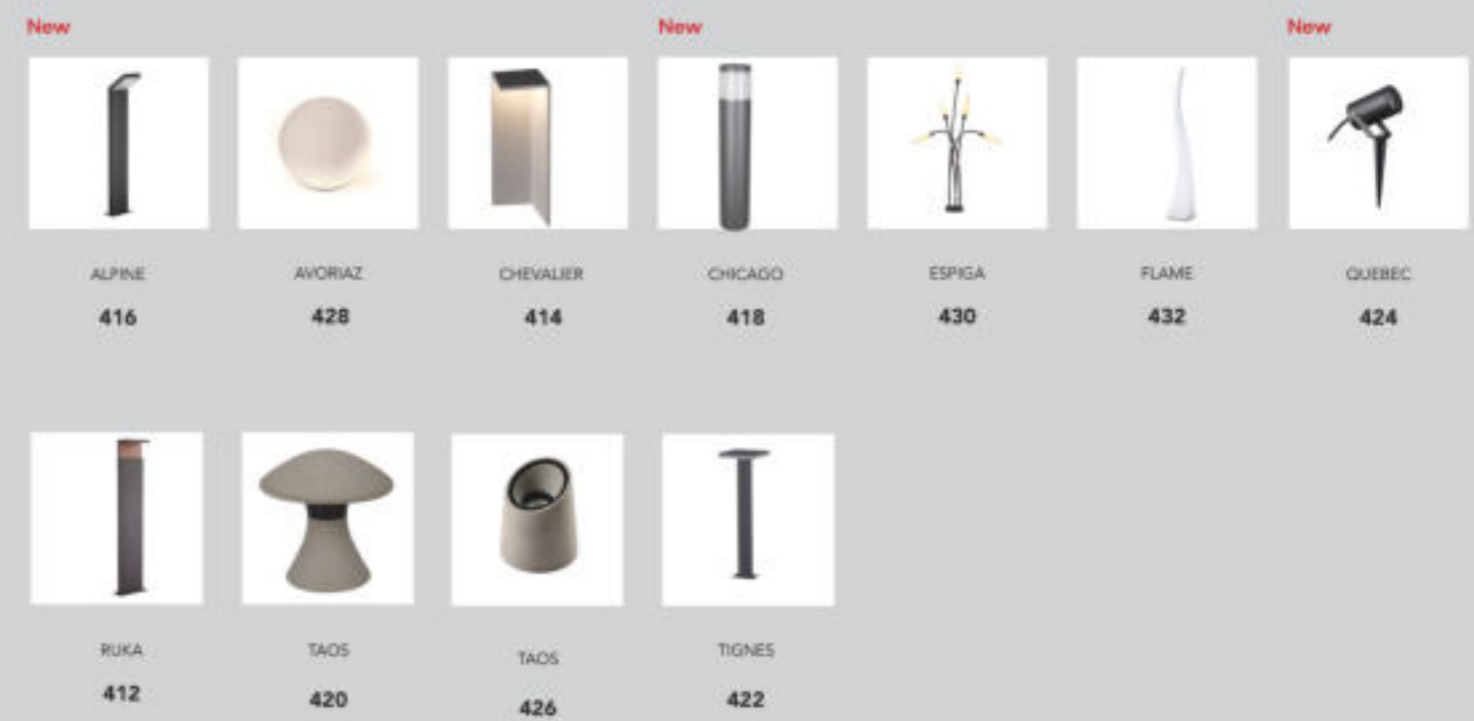

### Bañadores/Step lights



### Accesorios/Accessories



## BOMBILLAS/BULB

### Bombillas/Bulb



# FUJI

by José Ignacio Ballester

Apliques-Wall lights

Indoor



14W

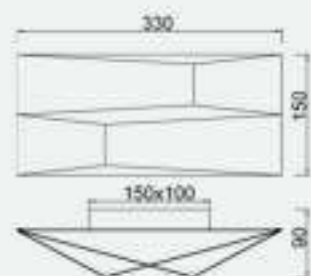

10W

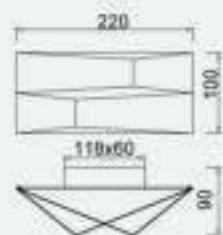

REFERENCE	K	LED WATT	LUMENS	FINISH
New 8156	3000K	10W	920lm	Blanco-White
New 8157	3000K	10W	920lm	Negra-Black
New 8158	3000K	14W	1250lm	Blanco-White
New 8159	3000K	14W	1250lm	Negra-Black
220-240V- 50/60Hz CRI: > 80				Metal-Metal





# ORION

by Hugo Tejada

Apliques-Wall lights

Indoor



REFERENCE	K	LED WATT	LUMENS	FINISH	SIZES
New 8122	3000K	8W	560lm	Negro+blanco-Black+white	ø250
New 8123	3000K	8W	560lm	Negro+Madera-Black+Wood	ø250
New 8124	3000K	8W	560lm	Negro+Pan oro-Black+Gold leaf	ø250
New 8125	3000K	20W	1400lm	Negro+blanco-Black+white	ø400
New 8126	3000K	20W	1400lm	Negro+Madera-Black+Wood	ø400
New 8127	3000K	20W	1400lm	Negro+Pan oro-Black+Gold leaf	ø400
New 8128	3000K	24W	1680lm	Negro+blanco-Black+white	ø500
New 8129	3000K	24W	1680lm	Negro+Madera-Black+Wood	ø500
New 8130	3000K	24W	1680lm	Negro+Pan oro-Black+Gold leaf	ø500

220-240V - 50/60Hz CRI ≥80

Hierro/Acrílico-Iron/Acrylic

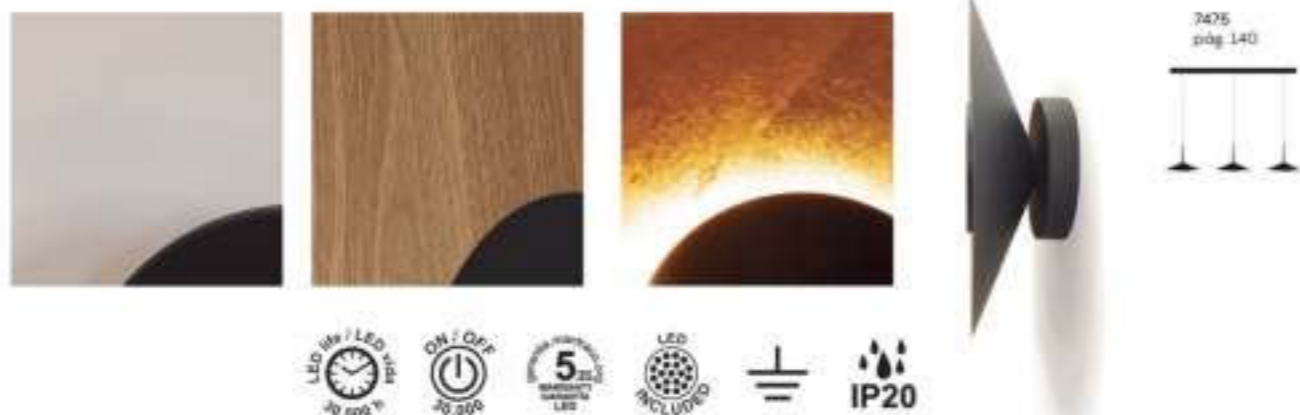

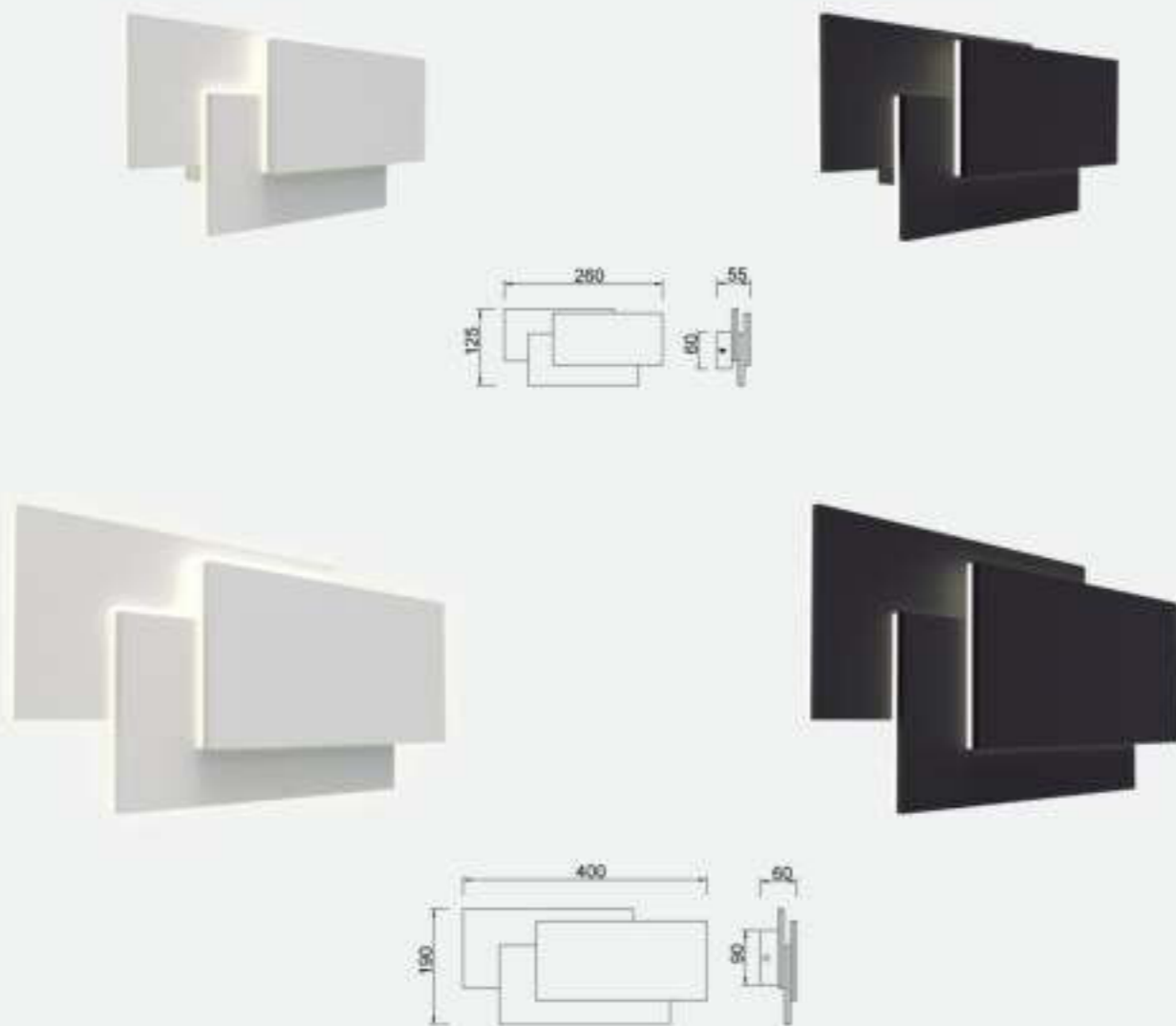

REFERENCE	K	LED WATT	LUMENS	FINISH
New 8089	3000K	12W	1080lm	Blanco-White
New 8090	3000K	12W	1080lm	Negro-Black
New 8087	3000K	36W	3240lm	Blanco-White
New 8086	3000K	36W	3240lm	Negro-Black

220-240V - 50/60Hz CRI: > 80    Aluminio/Acrílico - Aluminium/Acrylic



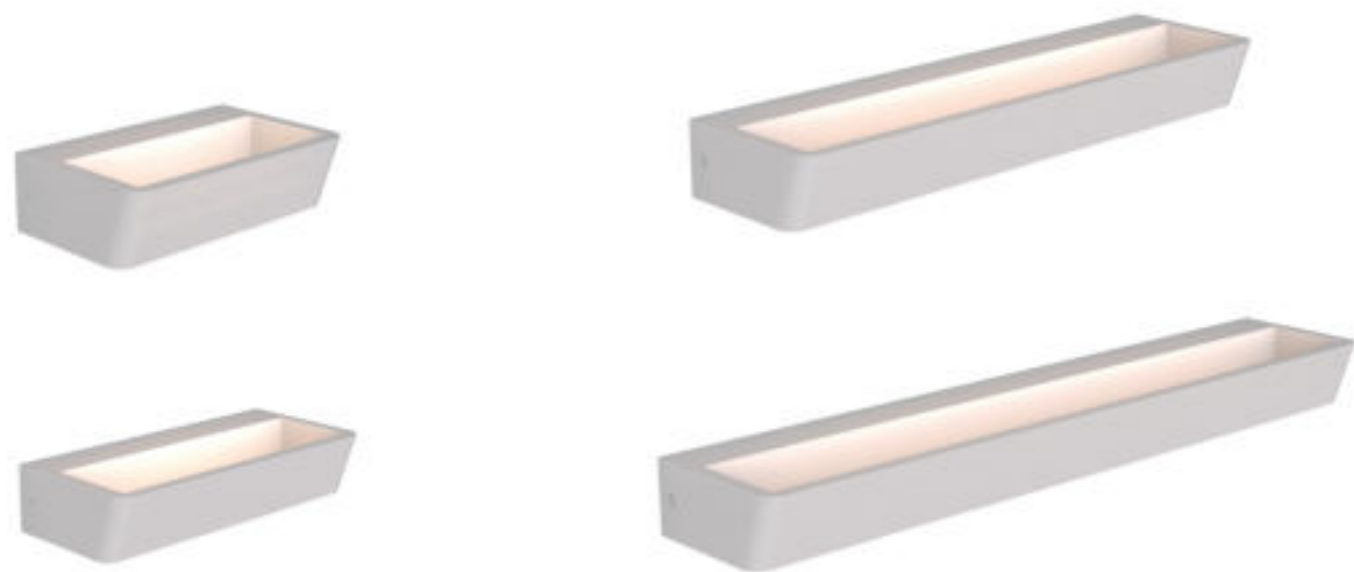

REFERENCE	K	LED WATT	LUMENS	FINISH
New 8094	3000K	15W	1200lm	Blanco arena-Sand white
New 8098	4000K	15W	1275lm	Blanco arena-Sand white
New 8093	3000K	21W	1680lm	Blanco arena-Sand white
New 8097	4000K	21W	1785lm	Blanco arena-Sand white
New 8092	3000K	30W	2400lm	Blanco arena-Sand white
New 8096	4000K	30W	2550lm	Blanco arena-Sand white
New 8091	3000K	40W	3200lm	Blanco arena-Sand white
New 8095	4000K	40W	3400lm	Blanco arena-Sand white

220-240V - 50/60Hz CRI: > 80 Aluminio/Acrílico - Aluminium/Acrylic



# TOBAGO

Apliques - Wall lights

Indoor



REFERENCE	K	LED WATT	LUMENS	FINISH
<b>New</b> 7910	3000K	7W	590lm	Blanco-White
<b>New</b> 7913	3000K	7W	590lm	Negro-Black
<b>New</b> 7911	3000K	9W	760lm	Blanco-White
<b>New</b> 7914	3000K	9W	760lm	Negro-Black
<b>New</b> 7912	3000K	12W	1010lm	Blanco-White
<b>New</b> 7915	3000K	12W	1010lm	Negro-Black
220-240V - 50/60Hz CRI: ≥ 90				Aluminio-Aluminium

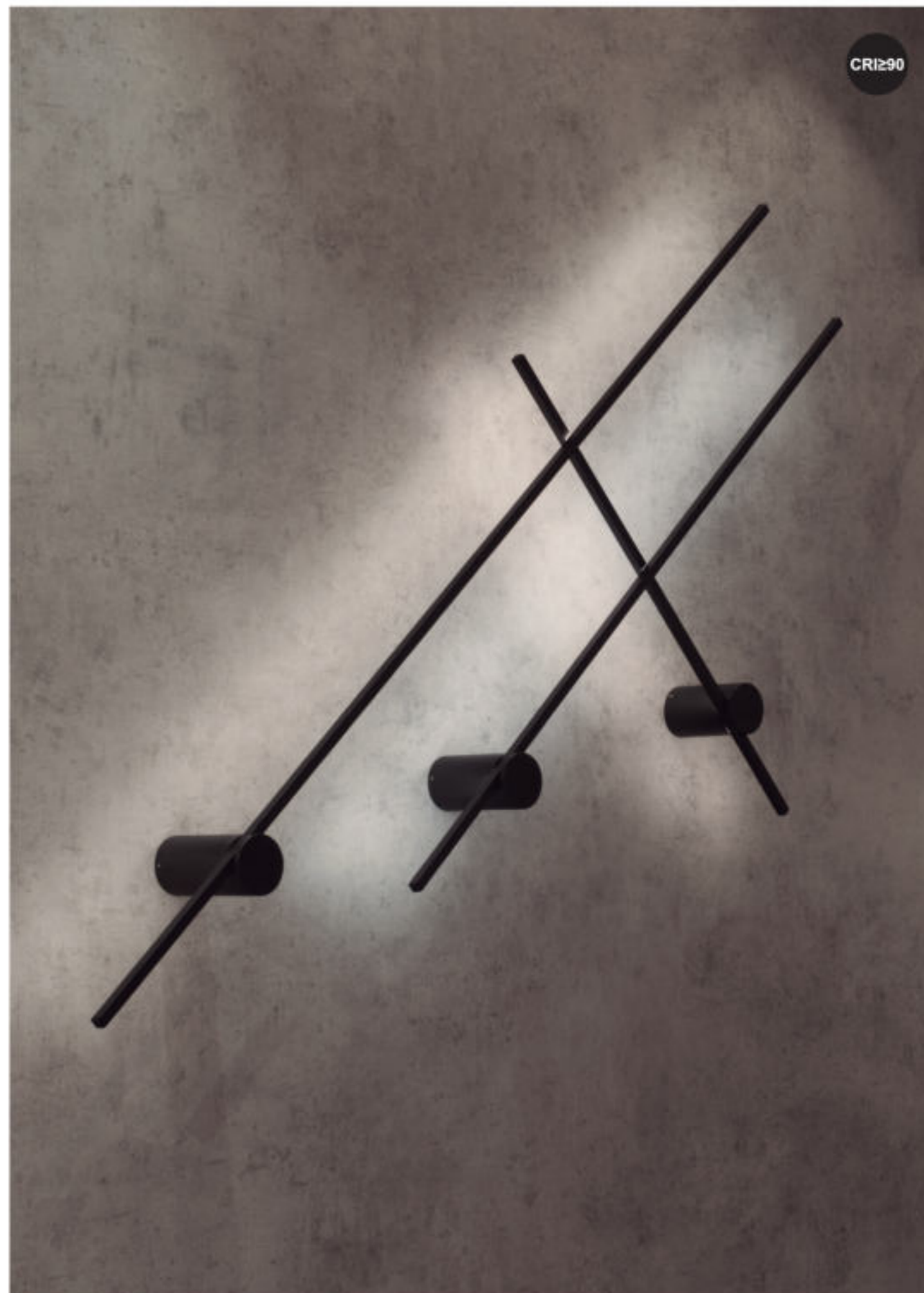
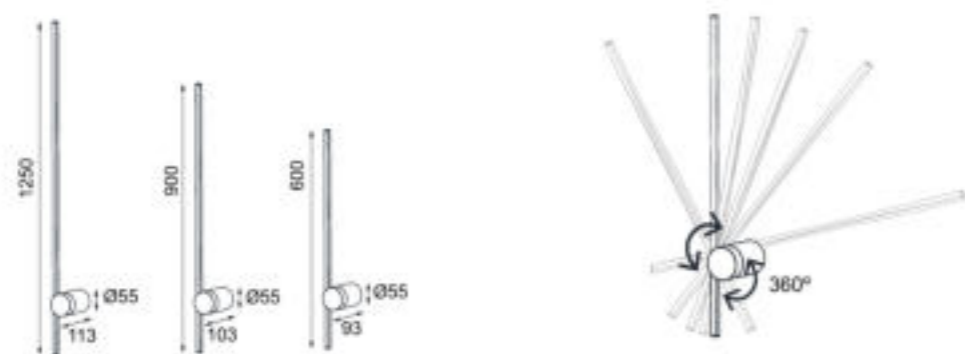



REFERENCE	K	LED WATT	LUMENS	FINISH
7774	3000K	14W	950lm	Bianco-White
7776	3000K	14W	950lm	Negro-Black
7778	3000K	14W	950lm	Arena-Sabbia
7775	4000K	14W	1000lm	Bianco-White
7777	4000K	14W	1000lm	Negro-Black
220-240V-50/60Hz CRi > 80				Aluminio-Aluminium

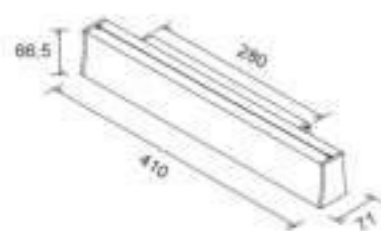

# HANOK

by David Villalba

Apliques - Wall lights

Indoor



REFERENCE	K	LED WATT	LUMENS	FINISH
7770	3000K	38 W	2850lm	Blanco-White
7772	3000K	38 W	2850lm	Negro-Black
7771	4000K	38 W	3000lm	Blanco-White
7773	4000K	38 W	3000lm	Negro-Black
220-240V - 50/60Hz CRI: ≥ 80				Aluminio-Aluminium

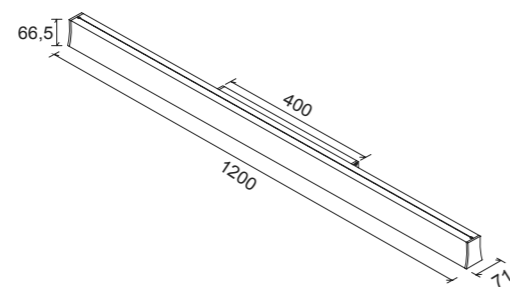

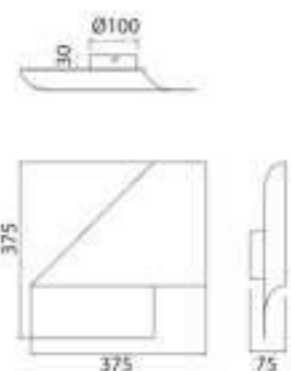

REFERENCE	BULB (No incl)	FINISH
7693	1L x GX53	Bianco-White
7694	1L x GX53	Negro-Black
7695	1L x GX53	Arena-Sabbia
máx. 15W LED (No incl)		100-240V - 50/60Hz Metal-Metal



Bombillas recomendadas-Suggested bulbs

REFERENCE	Wattos LED	K	Lumens	Ángulo luz
R09224	9W	3000K	730lm	120°
R09226	9W	4000K	740lm	120°
R09248	12W	3000K	930lm	120°
R09249	12W	4000K	960lm	120°



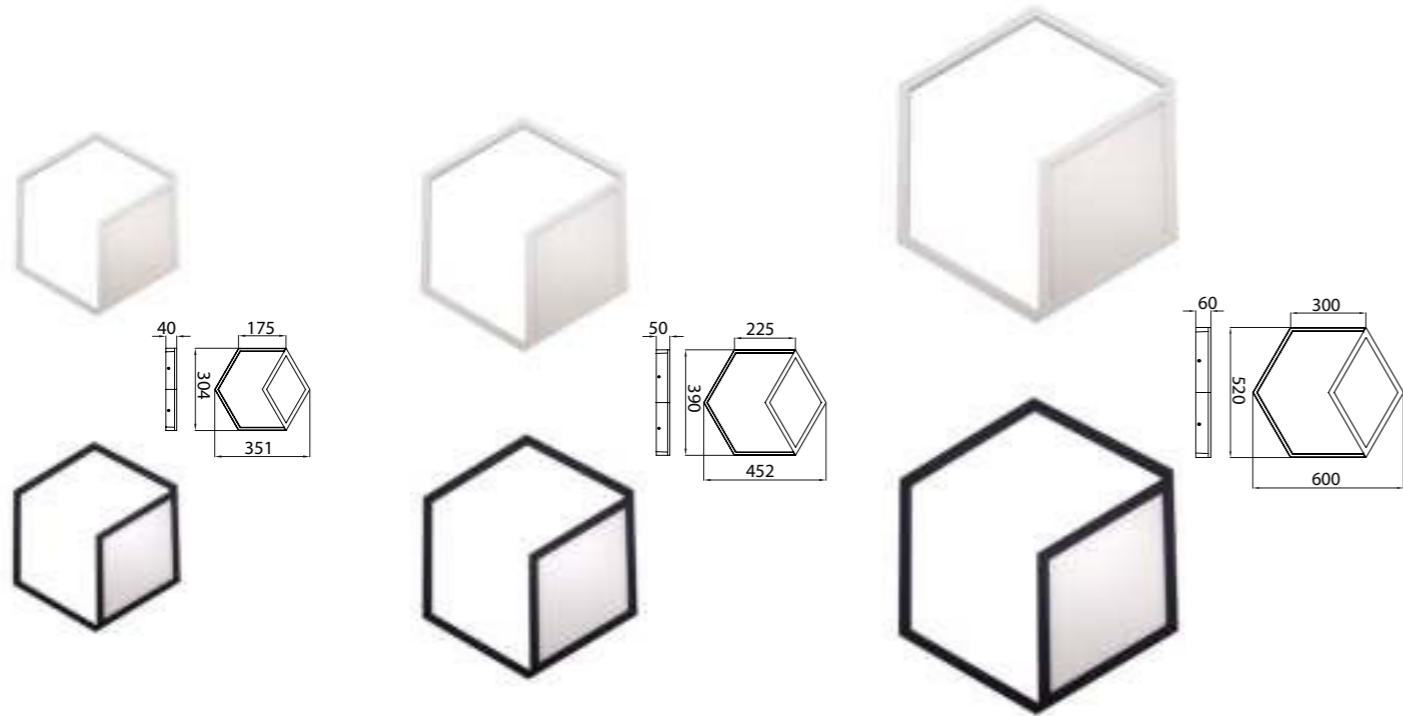

REFERENCE	K	LED WATT	LUMENS	FINISH	
7590	3000K	12W +14W	1630lm	Blanco mate-Matt white	On-off
7592	3000K	12W +14W	1630lm	Negro mate-Matt black	On-off
7591	3000K	12W +14W	1630lm	Blanco mate-Matt white	Dimmable
7593	3000K	12W +14W	1630lm	Negro mate-Matt black	Dimmable
7594	3000K	13,5W + 20W	1870lm	Blanco mate-Matt white	On-off
7596	3000K	13,5W + 20W	1870lm	Negro mate-Matt black	On-off
7595	3000K	13,5W + 20W	1870lm	Blanco mate-Matt white	Dimmable
7597	3000K	13,5W + 20W	1870lm	Negro mate-Matt black	Dimmable
7760	3000K	18W+30W	2700lm	Blanco mate-Matt white	On-off
7762	3000K	18W+30W	2700lm	Negro mate-Matt black	On-off
7761	3000K	18W+30W	2700lm	Blanco mate-Matt white	Dimmable
7763	3000K	18W+30W	2700lm	Negro mate-Matt black	Dimmable
				220-240V - 50/60Hz CRI: ≥ 80	Aluminio-Aluminium





# KUBICK

by José Ignacio Ballester

Apliques - Wall lights

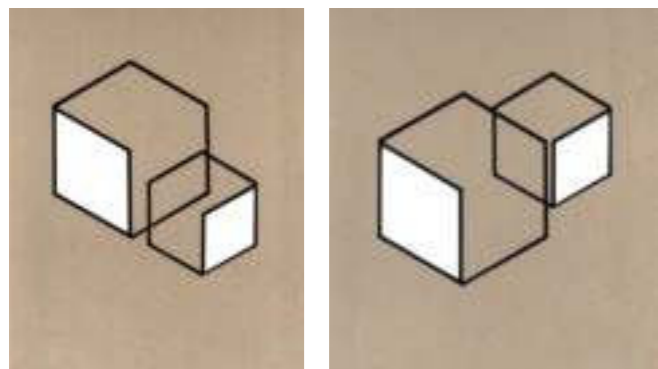
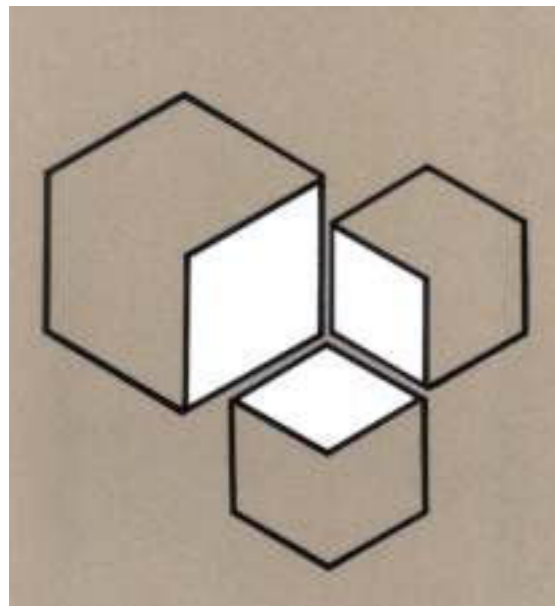
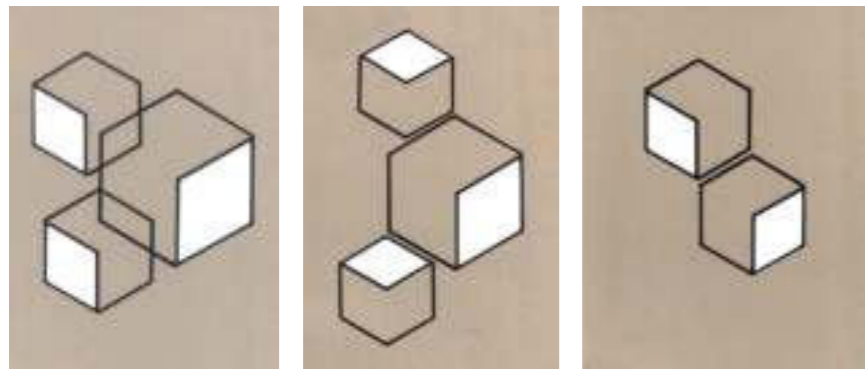
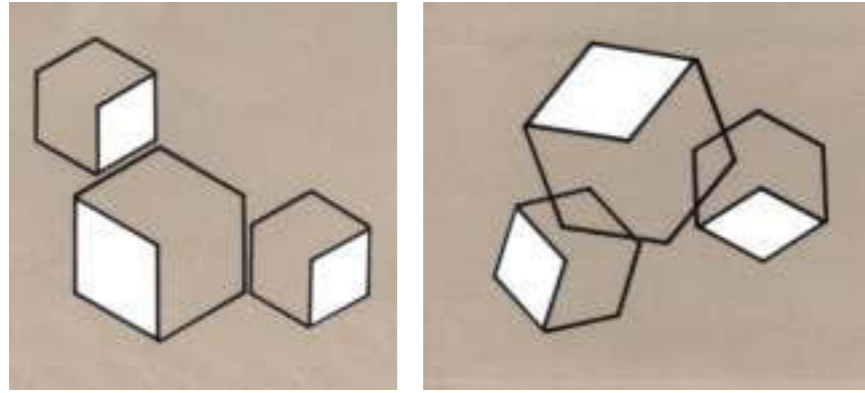

Indoor



# GOA

by José Ignacio Ballester

Apliques-Wall lights

Indoor



REFERENCE	K	LED WATT	LUMENS	FINISH	
7720	3000K	7.5W	660lm	Blanco mate-Matt white	Con interruptor With switch
7721	3000K	7.5W	660lm	Negro mate-Matt black	Con interruptor With switch
				Aluminio-Aluminium	

220-240V~50/60Hz CRI:≥ 80

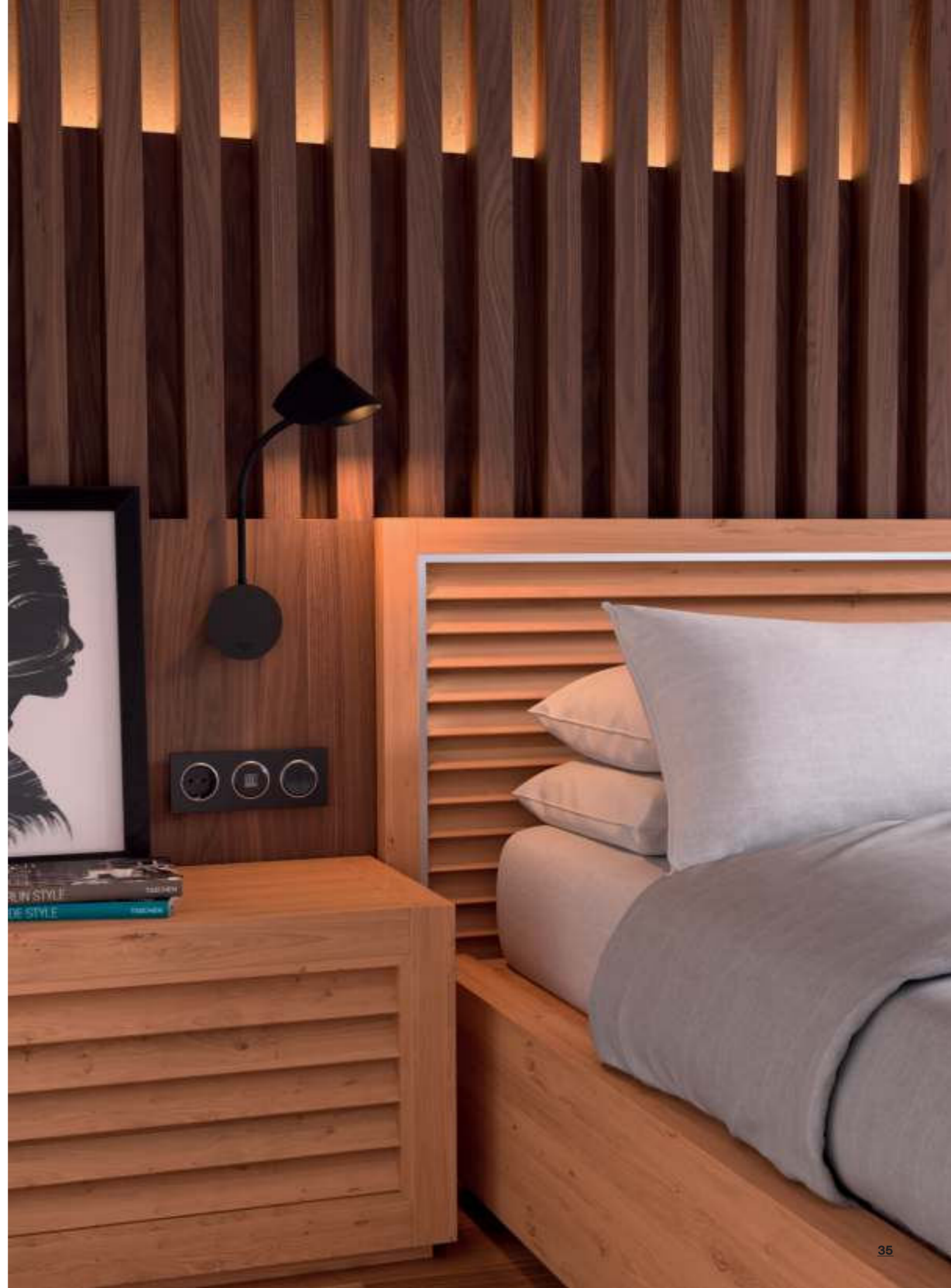
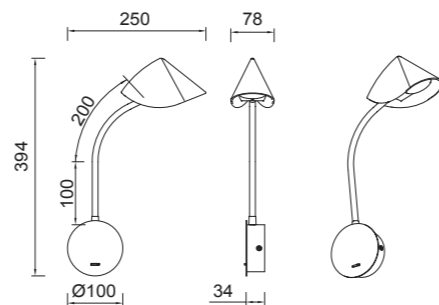



REFERENCE	K	LED WATT	LUMENS	FINISH	
7513	3000K	6W	390lm	Negro arena-Sand black	Sin interruptor No switch
7514	3000K	6W	390lm	Negro arena-Sand black	Con interruptor With switch
				220-240V - 50/60Hz CRI ≥ 80	Aluminio-Aluminium



# VENUS

by Hugo Tejada

Appliques - Wall lights

Indoor

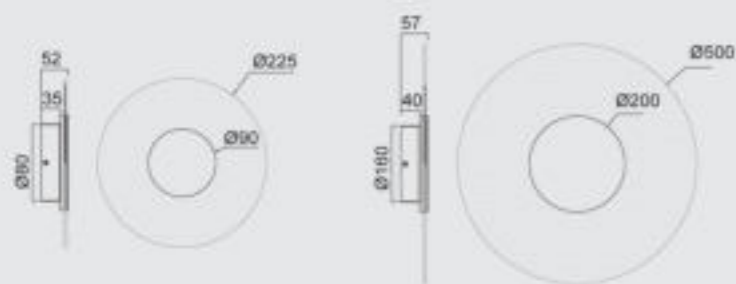
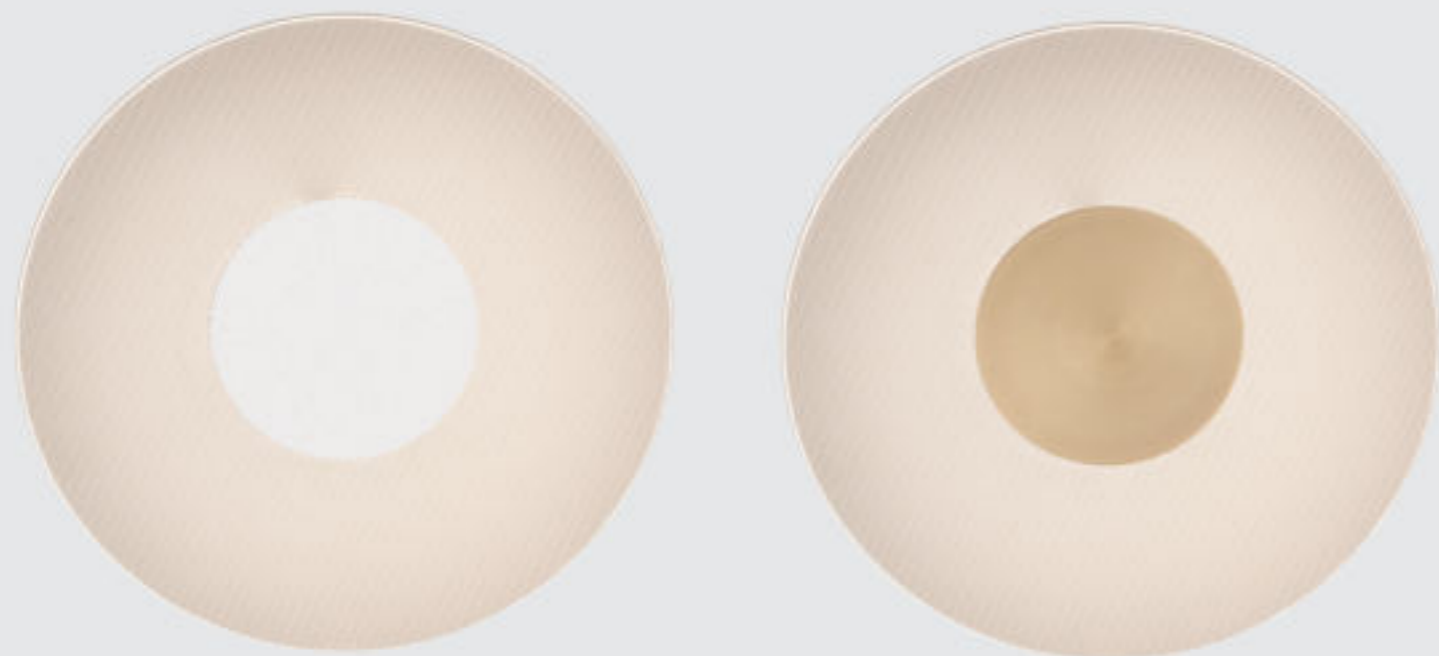

	REFERENCE	K	LED WATT	LUMENS	FINISH	SIZES
New	8010	3000K	9W	780lm	Blanco-White	Ø225
New	8011	3000K	9W	780lm	Negra-Black	Ø225
New	8034	3000K	9W	780lm	Oro-Gold	Ø225
New	8012	3000K	18W	1440lm	Blanco-White	Ø500
New	8013	3000K	18W	1440lm	Negra-Black	Ø500
New	8035	3000K	18W	1440lm	Oro-Gold	Ø500

220-240V - 50/60Hz CRI: 80

Aluminio/Acrílico - Aluminum/Acrylic

Registered N°007663331-0016

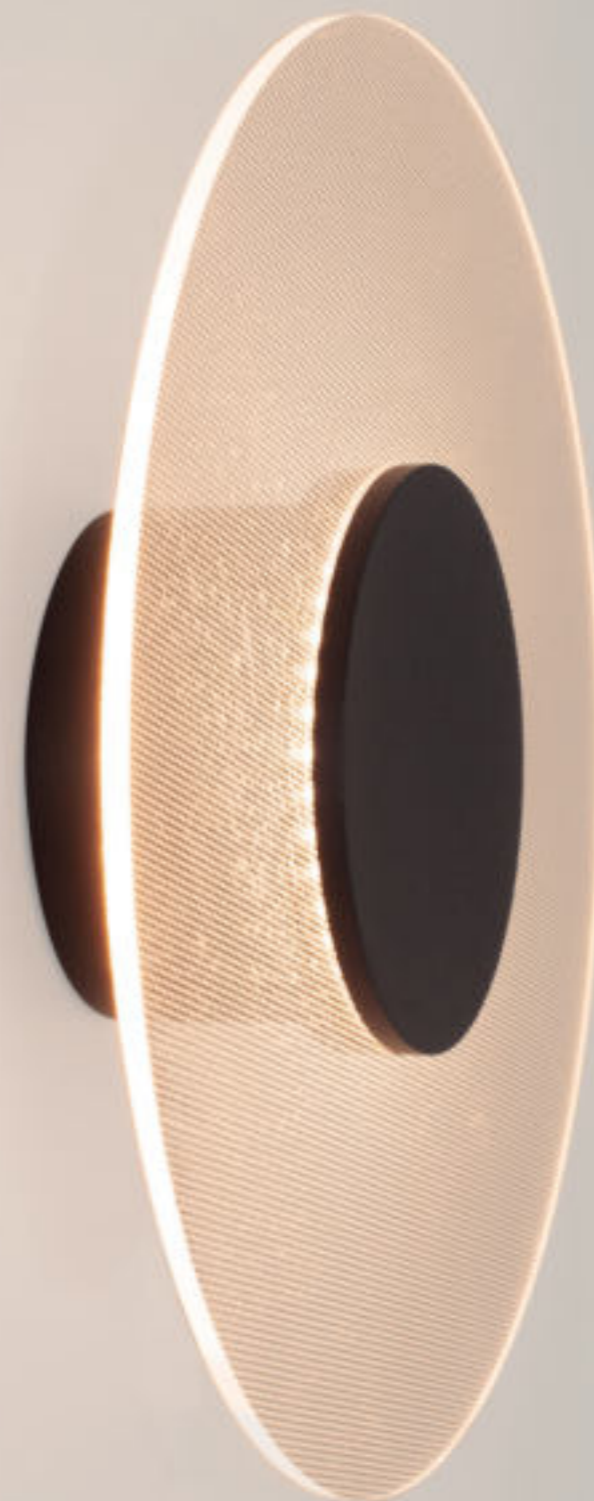

DRIVER  
TUV

# VENUS

by Hugo Tejada

Aplique/Perchero-Wall light/Coat Rack

Indoor



REFERENCE	K	LED WATT	LUMENS	FINISH
7293	3000K	6W	490lm	Negro-Black
7292	3000K	6W	490lm	Blanco-White

220-240V ~50/60Hz CRI≥ 80

Aluminio/acrílico-Aluminium/acrylic

Registered N°007663331-0016

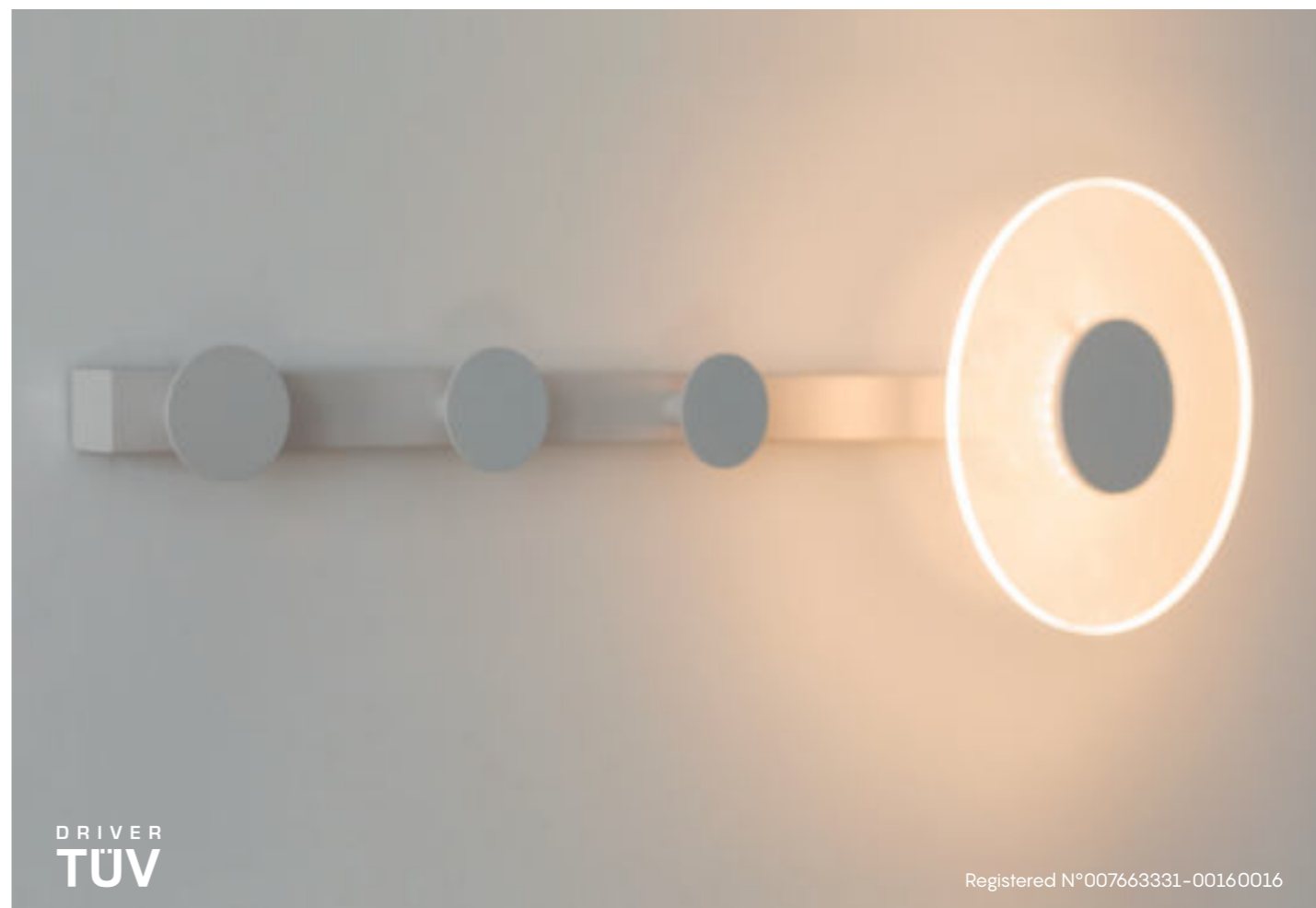
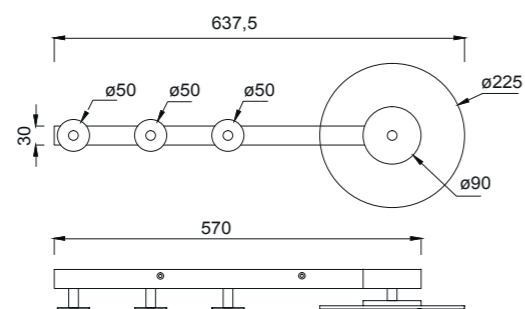

DRIVER  
TUV

Registered N°007663331-00160016

# ERIS

by Hugo Tejada



REFERENCE	K	LED WATT	LUMENS	FINISH
7296	3000K	8W	640lm	Blanco-White
7297	3000K	8W	640lm	Negro-Black
220-240V ~50/60Hz CRI ≥ 80				Aluminio-Aluminium

Registered N°007663331-0012

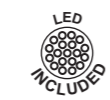
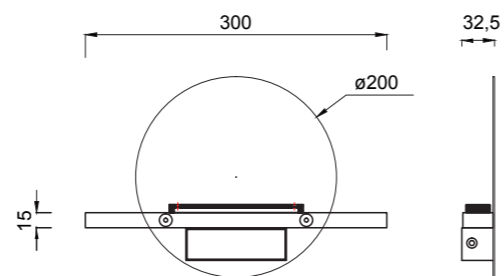

DRIVER  
TÜV

Registered N°007663331-0012

# ERIS

by Hugo Tejada

Apliques - Wall lights

Indoor

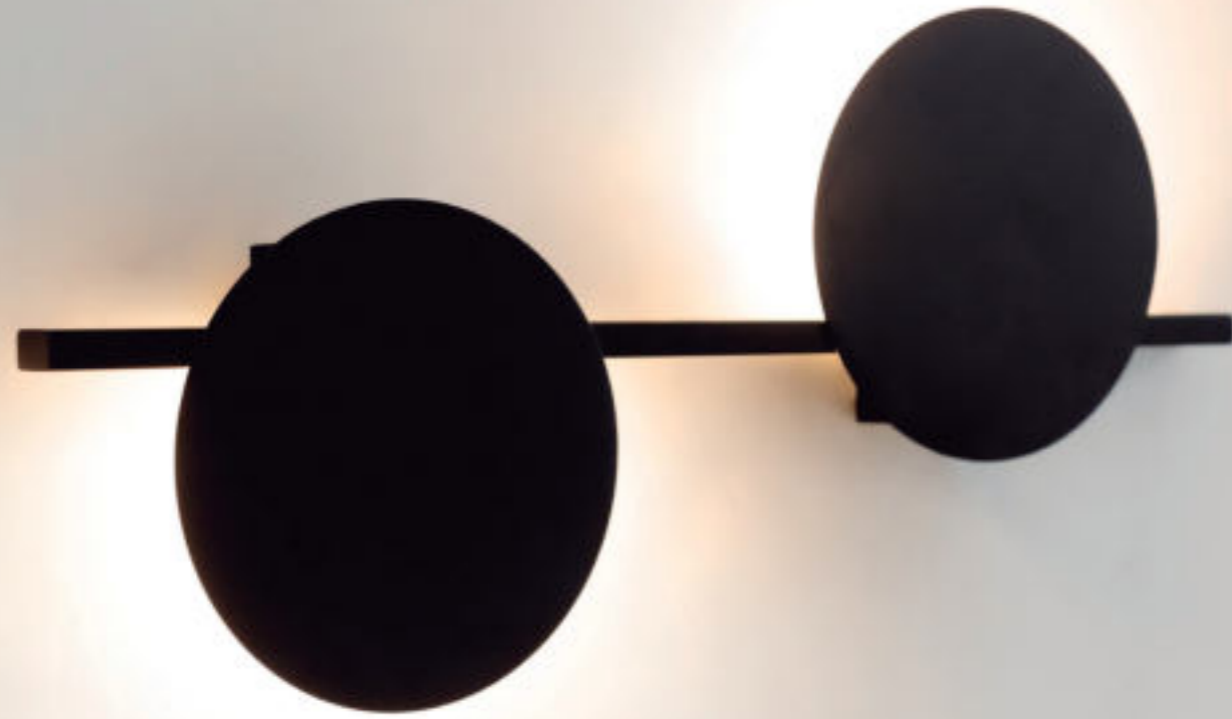

REFERENCE	K	LED WATT	LUMENS	FINISH
7298	3000K	16 W	1280lm	Blanco-White
7299	3000K	16 W	1280lm	Negro-Black
220-240V ~50/60Hz CRI ≥ 80				Aluminio-Aluminium

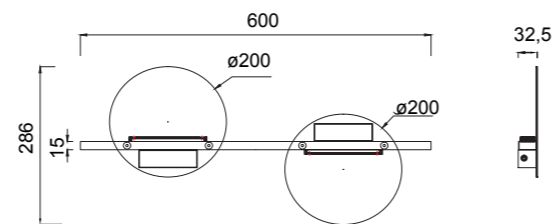
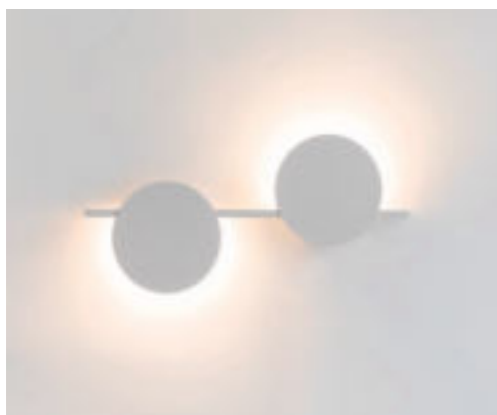

# ERIS

by Hugo Tejada



REFERENCE	K	LED WATT	LUMENS	FINISH
7300	3000K	24W	1920lm	Blanco-White
7301	3000K	24W	1920lm	Negro-Black
220-240V ~50/60Hz CRI ≥ 80				Aluminio-Aluminium

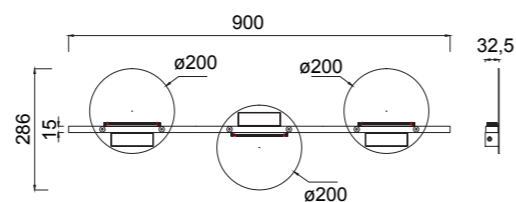
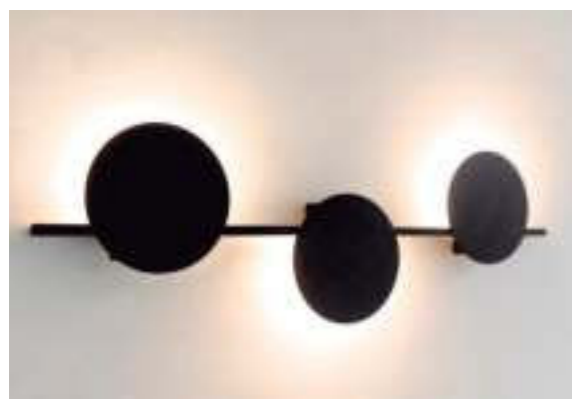

DRIVER TÜV

Registered N°007663331-0012



**POLAR**  
by Hugo Tejada

Aplique/Perchero-Wall light/Coat Rack

Indoor



REFERENCE	K	LED WATT	LUMENS	FINISH
7240	3000K	6W	540lm	Blanco-White
7241	3000K	6W	540lm	Negro-Black
220-240V~50/60Hz CRI≥ 80				Aluminio-Aluminium

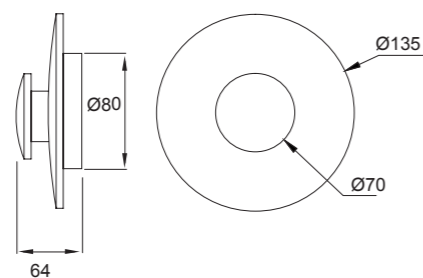

DRIVER  
TUV

Registered N° 007663331-0015

# DURBAN

Apliques-Wall lights

Indoor



REFERENCE	K	LED WATT	LUMENS	FINISH
7175	3000K	10W	780lm	Negro-Black
7176	3000K	20W	1550lm	Negro-Black
7177	3000K	30W	2300lm	Negro-Black
220-240V~50/60Hz CRi: 80				Aluminio-Aluminium

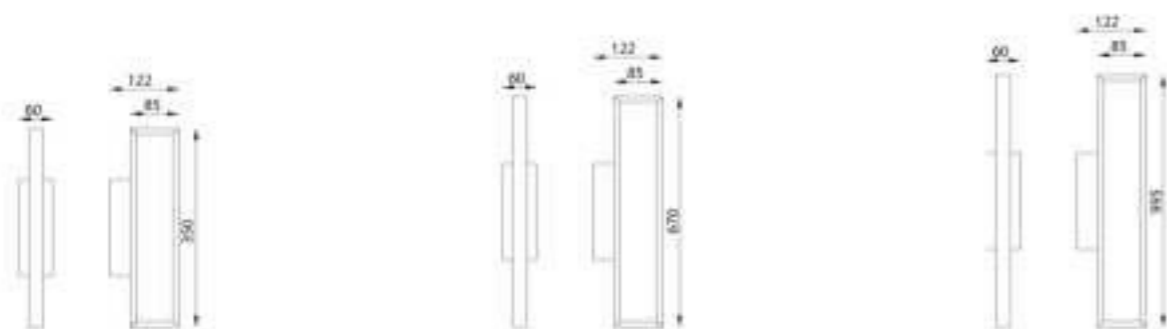

DRIVER  
TUV



REFERENCE	K	LED WATT	LUMENS	FINISH
7197	3000K	10W	780lm	Blanco-White
7198	3000K	20W	1550lm	Blanco-White
7199	3000K	30W	2300lm	Blanco-White
220-240V~50/60Hz CRi: 80				Aluminio-Aluminium

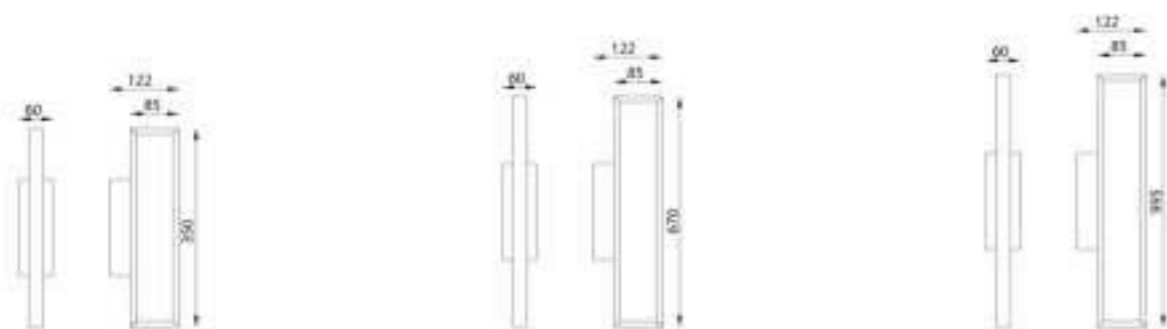



REFERENCE	K	LED WATT	LUMENS	FINISH
7482	4000K	12W	1080lm	Negra-Black
6760	4000K	12W	1080lm	Cromo-Chrome
6763	4000K	12W	1080lm	Blanca-White
7483	4000K	16W	1440lm	Negra-Black
6761	4000K	16W	1440lm	Cromo-Chrome
7480	4000K	16W	1440lm	Blanca-White
7484	4000K	20W	1800lm	Negra-Black
6762	4000K	20W	1800lm	Cromo-Chrome
7481	4000K	20W	1800lm	Blanca-White

220-240V-50/60Hz CRi ≥ 80      Aluminio/Pc-Aluminium

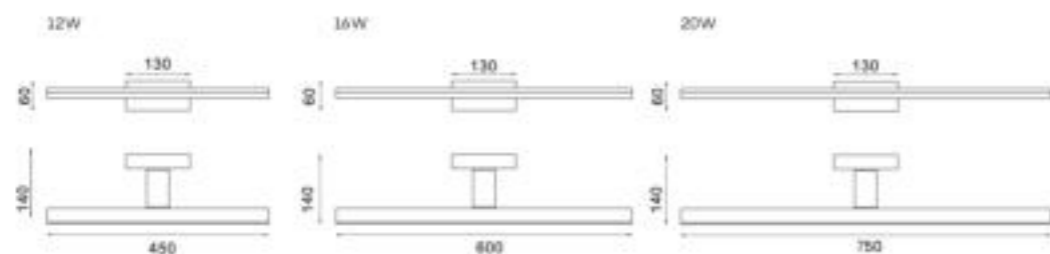

# ASIMETRIC

by Santolaria & Lluscà

Apliques-Wall lights

Indoor



Registered N° 004721413-026

REFERENCE	BU&B (No incl)	FINISH
6220	1L x GX53	Blanco-White
6221	1L x GX53	Blanco-White
6222	1L x GX53	Negro-Black
máx. 12W LED (No incl)		100-240V-50/60Hz Metal-Metal

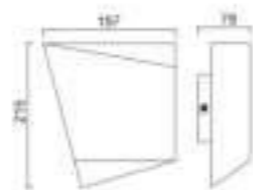

Bombillas recomendadas-Suggested bulbs

REFERENCE	Wattos LED	CCT	Lumens	Ángulo luz
R09224	9W	3000K	730lm	120°
R09225	9W	4000K	740lm	120°
R09248	12W	3000K	930lm	120°
R09249	12W	4000K	960lm	120°



6221



6220

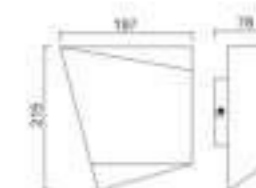
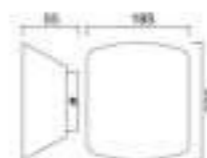



REFERENCE	K	LED WATT	LUMENS	FINISH
6750	3000K	3W	210lm	Blanco arena-Sand white
6752	3000K	3W	210lm	Negro arena-Sand black
		100-240V-50/60Hz CRI: 80		Aluminio/Metal-Aluminium/Metal

 \*Cargador Inalámbrico de inducción-Wireless Induction Charger

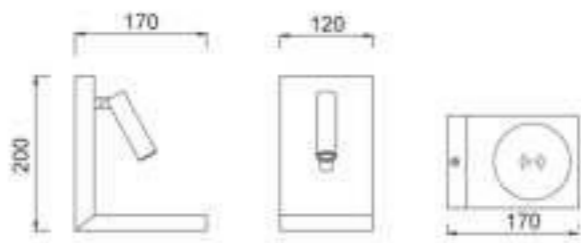



REFERENCE	K	LED WATT	LUMENS	FINISH
6754	3000K	3W	210lm	Blanco mate-Matt white
6755	3000K	3W	210lm	Negro mate-Matt black
		100-240V~50/60Hz	CRI≥ 80	Aluminio/Metal-Aluminium/Metal



\*Cargador Inalámbrico de inducción-Wireless Induction Charger

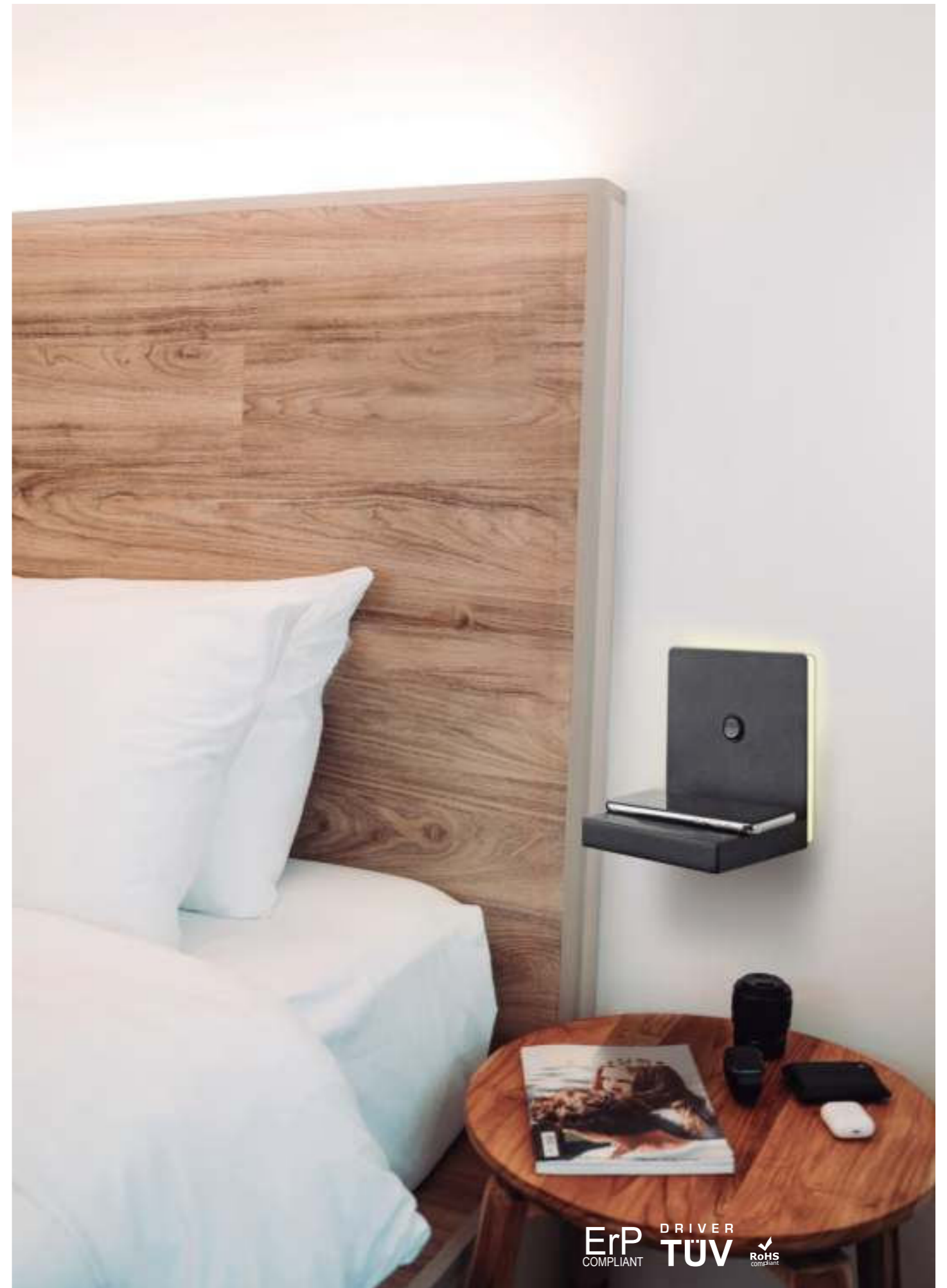
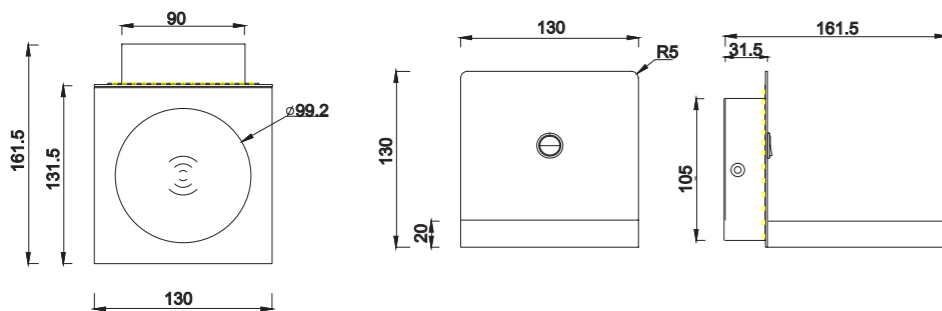

ErP COMPLIANT DRIVER TÜV RoHS COMPLIANT



REFERENCE	K	LED WATT	LUMENS	FINISH
6751	3000K	6W	470lm	Blanco mate-Matt white
6753	3000K	6W	470lm	Negro mate-Matt black
		220-240V-50/60Hz	CRI: 80	Aluminio/Metal-Aluminium/Metal

 \*Cargador Inalámbrico de inducción-Wireless Induction Charger

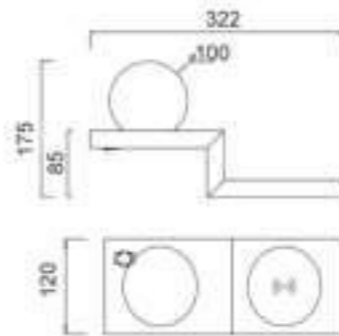





REFERENCE	K	LED WATT	LUMENS	FINISH
6865	3000K	9W	600lm	Blanco mate - Matt white
6866	3000K	9W	600lm	Negro mate - Matt black
100-250V ~ 50/60Hz CRI: ≥ 80				Acero/Acrílico - Steel/Acrylic

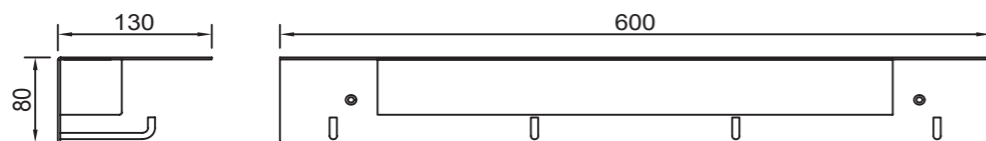



REFERENCE	K	LED WATT	LUMENS	FINISH
6700	3000K	6W	410lm	Bianco mate-Matt white
6701	3000K	6W	410lm	Negro mate-Matt black
220-240V-50/60Hz CRI≥ 80				Aluminio-Aluminium

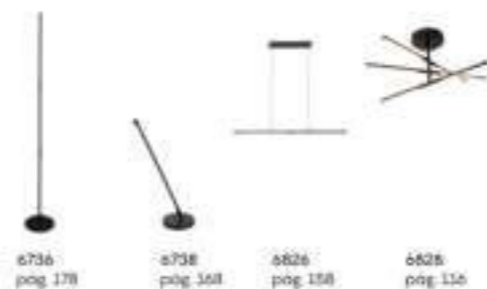



REFERENCE	K	LED WATT	LUMENS	FINISH
6702	3000K	6W+3W	410lm+210lm	Bianco mate-Matt white
6703	3000K	6W+3W	410lm+210lm	Negro mate-Matt black
220-240V-50/60Hz CRI> 80				Aluminio-Aluminum





REFERENCE	BULB (No incl)	FINISH	
7523	1L x GU10	Bianco mate-Matt white	Sin interruptor No switch
7518	1L x GU10	Negro mate-Matt black	Sin interruptor No switch
7524	1L x GU10	Bianco mate-Matt white	Con interruptor With switch
7519	1L x GU10	Negro mate-Matt black	Con interruptor With switch
	max. 10W LED (No incl)	100-240V - 50/60Hz Aluminio-Aluminium	



ErP COMPLIANT  
RoHS COMPLIANT



Bombillas recomendadas-Suggested bulbs

K	Wat LED	On/Off	Dimmable	Lumens
2700K	7W	R09254	R09257	510lm
3000K	7W	R09255	R09258	540lm
4000K	7W	R09256	R09259	570lm





REFERENCE	BULB (No incl)	FINISH	
6283	1L x GU10	Blanco mate-Matt white	Sin interruptor No switch
6713	1L x GU10	Negro mate-Matt black	Sin interruptor No switch
6284	1L x GU10	Blanco mate-Matt white	Con interruptor With switch
6714	1L x GU10	Negro mate-Matt black	Con interruptor With switch
máx. 10W LED (No incl)		100-240V - 50/60Hz Aluminio-Aluminium	



Bombillas recomendadas-Suggested bulbs

K	Wat LED	On/Off	Dimmable	Lumens
2700K	7W	R09254	R09257	510lm
3000K	7W	R09255	R09258	540lm
4000K	7W	R09256	R09259	570lm

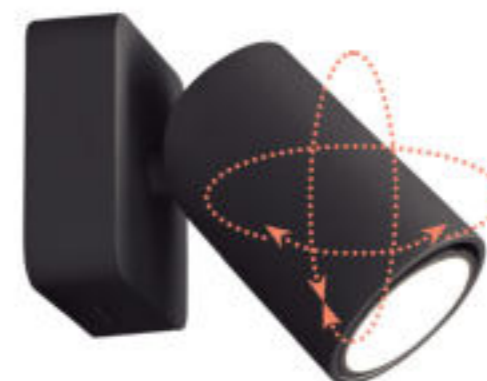

# CAYMAN

Apliques-Wall lights

Indoor



REFERENCE	K	LED WATT	LUMENS	FINISH
6080	3000K	3+6W	210+410lm	Blanco mate-Matt white
6081	3000K	3+6W	210+410lm	Niquel satinado-Satin nickel
6082	3000K	3+6W	210+410lm	Cuero-Antique brass
6083	3000K	3+6W	210+410lm	Negro mate-Matt black
<b>New</b> 7853	3000K	3+6W	210+410lm	Oro-Gold
				Aluminio-Aluminium

220-240V- 50/60Hz CRI ≥ 80



REFERENCE	K	LED WATT	LUMENS	FINISH
<b>New</b> 7823	3000K	3+6W	210+410lm	Blanco mate-Matt white
<b>New</b> 7824	3000K	3+6W	210+410lm	Niquel satinada-Satin nickel
<b>New</b> 7825	3000K	3+6W	210+410lm	Cuero-Antique brass
<b>New</b> 7826	3000K	3+6W	210+410lm	Negro mate-Matt black
<b>New</b> 7854	3000K	3+6W	210+410lm	Oro-Gold
				Aluminio-Aluminium

220-240V- 50/60Hz CRI ≥ 80



ErP COMPLIANT

RoHS COMPLIANT

# CABARETE

Apliques - Wall lights

Indoor

REFERENCE	K	LED WATT	LUMENS	FINISH
5715	3000K	3+3W	470lm	Blanco mate - Matt white
		220-240V - 50/60Hz CRI: ≥ 80		Aluminio - Aluminium

REFERENCE	K	LED WATT	LUMENS	FINISH
5714	3000K	3+3W	470lm	Negro mate - Matt black
		220-240V - 50/60Hz CRI: ≥ 80		Aluminio - Aluminium

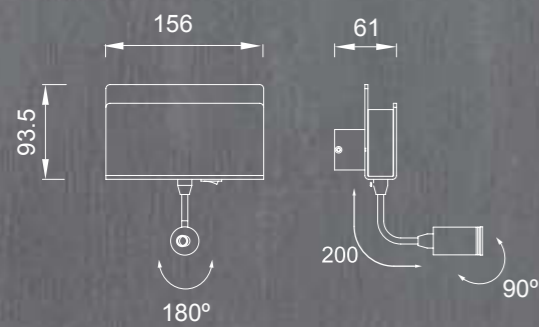

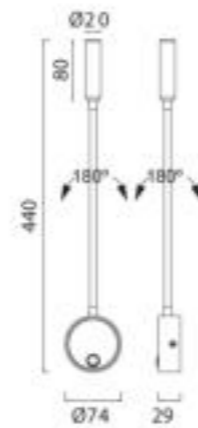

REFERENCE	K	LED WATT	LUMENS	FINISH
6046	3000K	3W	185lm	Blanco-White
6047	3000K	3W	185lm	Negro-Black
				Aluminio/acrílico - Aluminium/acrylic

220-240V - 50/60Hz CRI ≥ 80

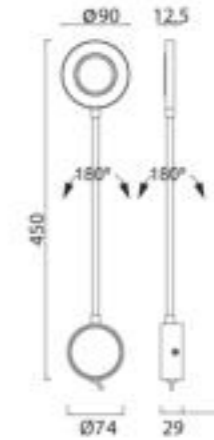

REFERENCE	K	LED WATT	LUMENS	FINISH
6050	3000K	5W	285lm	Blanco-White
6051	3000K	5W	285lm	Negro-Black
				Aluminio-Aluminium

220-240V - 50/60Hz CRI ≥ 80

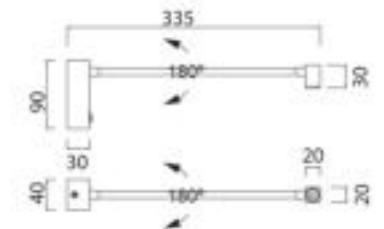

REFERENCE	K	LED WATT	LUMENS	FINISH
6048	3000K	3W	185lm	Blanco-White
6049	3000K	3W	185lm	Negro-Black
				Aluminio-Aluminium

220-240V - 50/60Hz CRI ≥ 80







REFERENCE	K	LED WATT	LUMENS	FINISH
6820	3000K	3W	210lm	Bianco arena-Sand white
6821	3000K	3W	210lm	Negro arena-Sand black
100-240V-50/60Hz CRt= 80				Aluminio-Aluminium

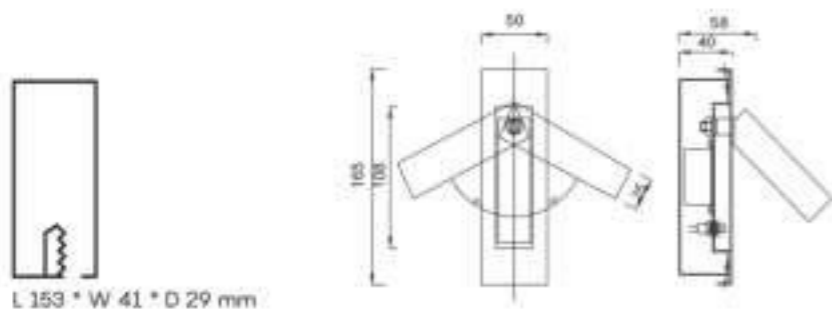

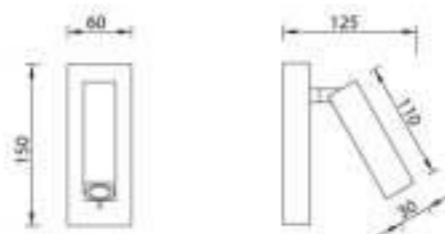

REFERENCE	K	LED WATT	LUMENS	FINISH
6070	3000K	3W	210lm	Blanco mate-Matt white
6071	3000K	3W	210lm	Niquel satinado-Satin nickel
6072	3000K	3W	210lm	Cuero-Antique brass
100-240V-50-60Hz CRt > 80				Aluminio-Aluminium





REFERENCE	K	LED WATT	LUMENS	FINISH
6075	3000K	3W	210lm	Blanco mate-Matt white
6076	3000K	3W	210lm	Niquel satinado-Satin nickel
6077	3000K	3W	210lm	Cuero-Antique brass
				Aluminio-Aluminium

100-240V-50/60Hz CRI ≥ 80

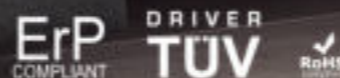
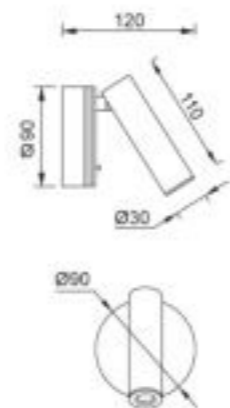



REFERENCE	BULB (No incl)	FINISH	LECTOR/READER	LUMENS
6091	1L x E27	Blanco mate - Matt white	3W	210lm
6092	1L x E27	Níquel Satinado - Satin Nickel	3W	210lm
6093	1L x E27	Cuero - Antique brass	3W	210lm
máx. 20W LED (No incl)		220-240V - 50/60Hz CRI: >= 80 Aluminio - Aluminium	Cargador USB /Charger USB	Pantalla blanca/White shade

**USB**  
Output

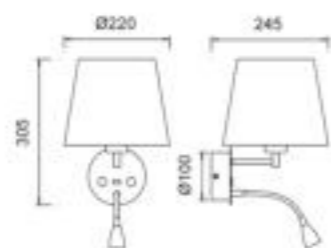

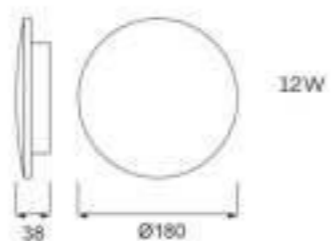
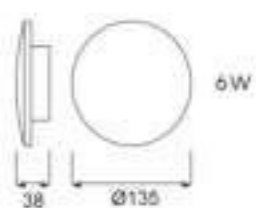
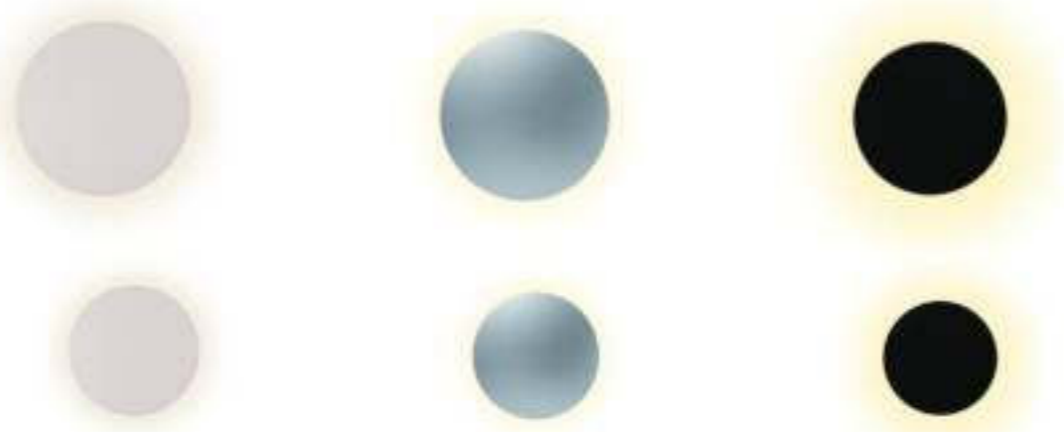

REFERENCE	K	LED WATT	LUMENS	FINISH
C0127	2700K	6W	420lm	Bianco-White
C0131	2700K	6W	420lm	Negro-Black
C0101	3000K	6W	540lm	Bianco-White
C0111	3000K	6W	540lm	Plata-Silver
C0119	3000K	6W	540lm	Negro-Black
C0128	2700K	12W	840lm	Bianco-White
C0132	2700K	12W	840lm	Negro-Black
C0102	3000K	12W	1080lm	Bianco-White
C0112	3000K	12W	1080lm	Plata-Silver
C0120	3000K	12W	1080lm	Negro-Black

220-240V-50/60Hz CRI ≥ 80      Aluminio-Aluminium

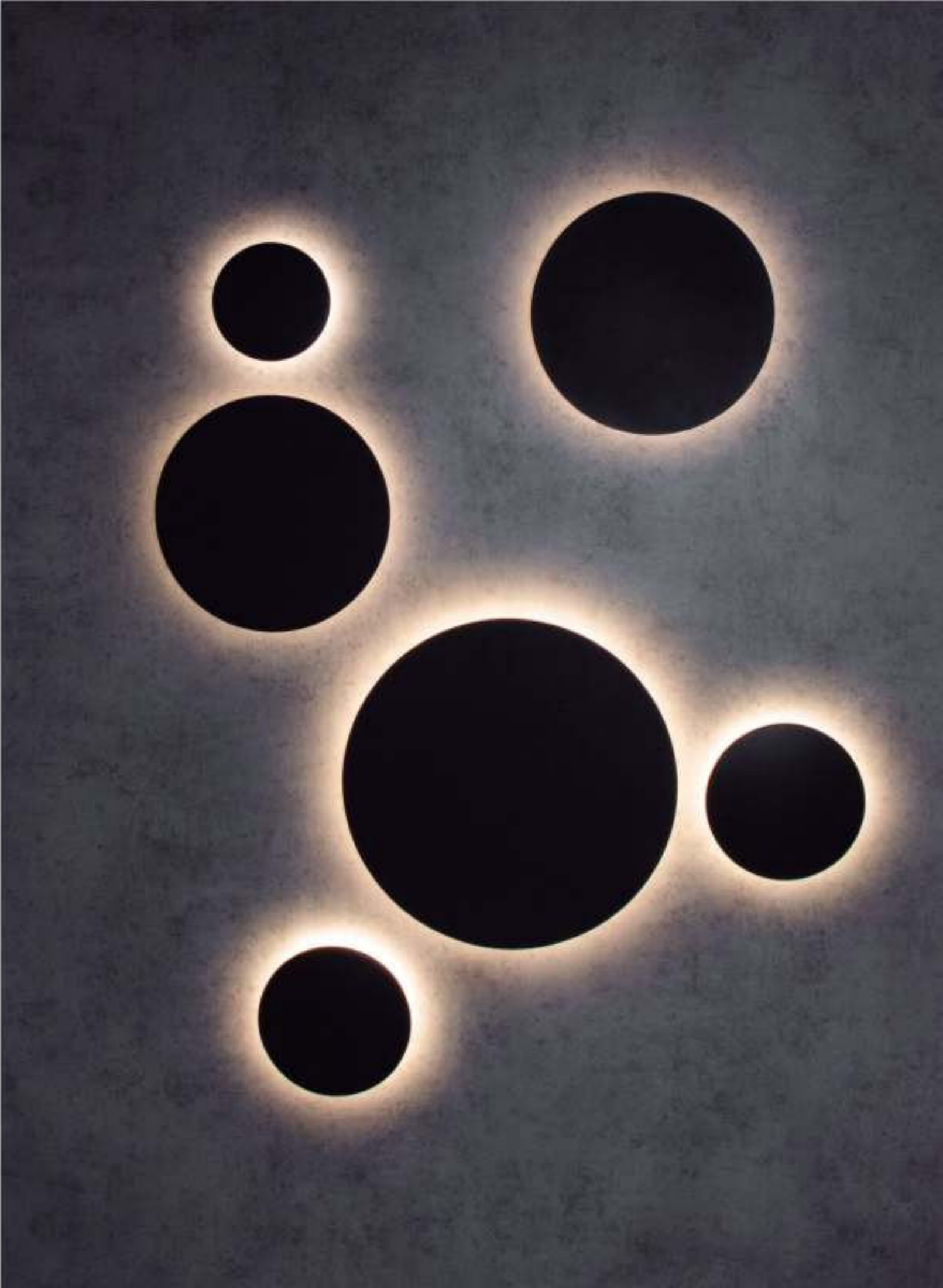

# BORA BORA

Apliques-Wall lights

Indoor

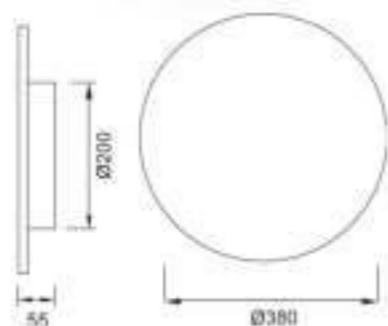
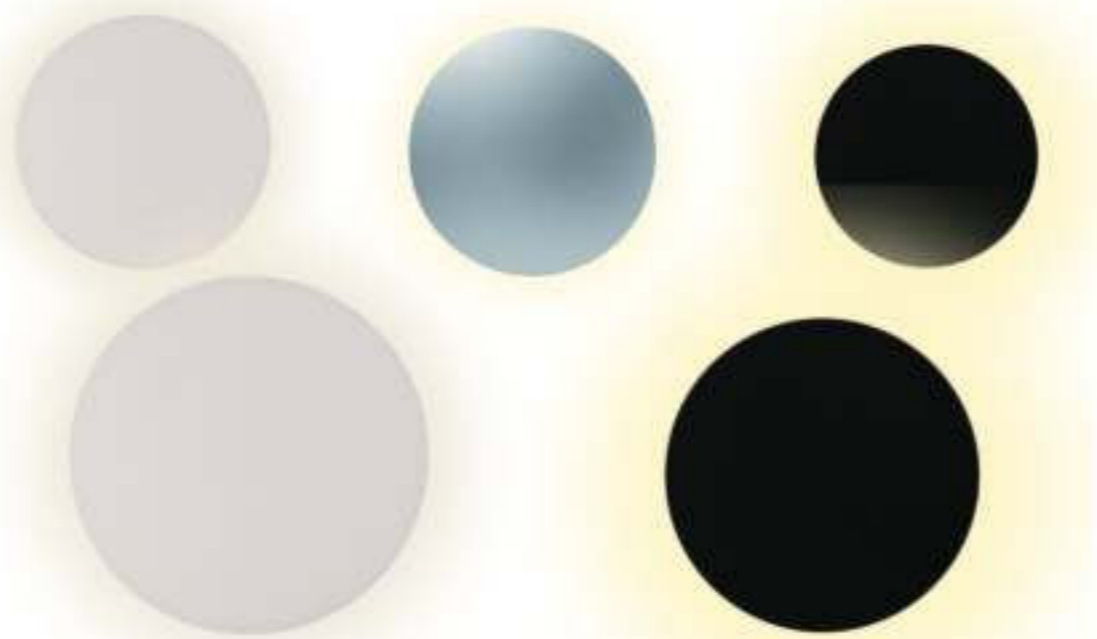

30W

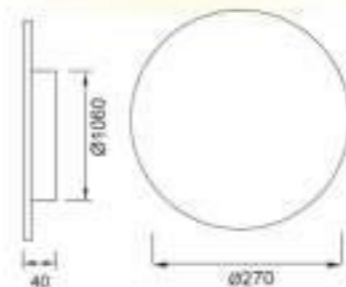

16W



REFERENCE	K	LED WATT	LUMENS	FINISH
C0129	2700K	16W	1120lm	Bianco-White
C0133	2700K	16W	1120lm	Negro-Black
C0117	3000K	16W	1350lm	Bianco-White
C0118	3000K	16W	1350lm	Plata-Silver
C0124	3000K	16W	1350lm	Negro-Black
C0130	2700K	30W	2100lm	Bianco-White
C0134	2700K	30W	2100lm	Negro-Black
C0125	3000K	30W	2400lm	Bianco-White
C0126	3000K	30W	2400lm	Negro-Black

220-240V-50/60Hz CRI: 80. Aluminium-Aluminium





C0103-C0113

C0104-C0114

C0115

C0116

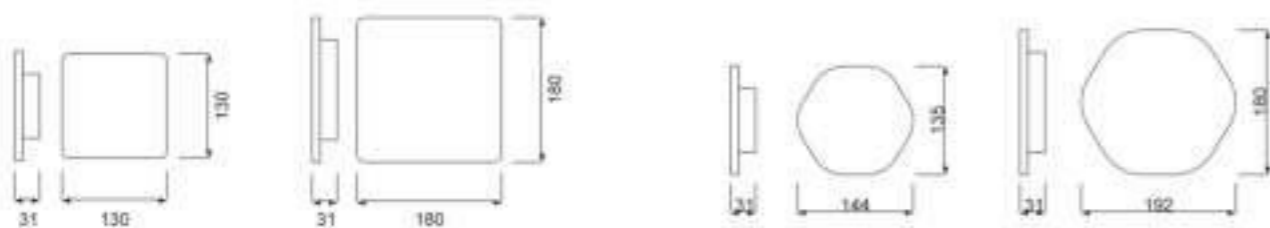

REFERENCE	K	LED WATT	LUMENS	FINISH	SIZES
C0103	3000K	6W	540lm	Bianco-White	130 x 130
C0113	3000K	6W	540lm	Plata-Silver	130 x 130
C0115	3000K	6W	540lm	Plata-Silver	144 x 135
C0104	3000K	12W	1080lm	Bianco-White	180 x 180
C0114	3000K	12W	1080lm	Plata-Silver	180 x 180
C0116	3000K	12W	1080lm	Plata-Silver	192 x 180

220-240V - 50/60Hz CRI: > 80      Aluminio-Aluminium





# MURAL

Apliques-Wall lights

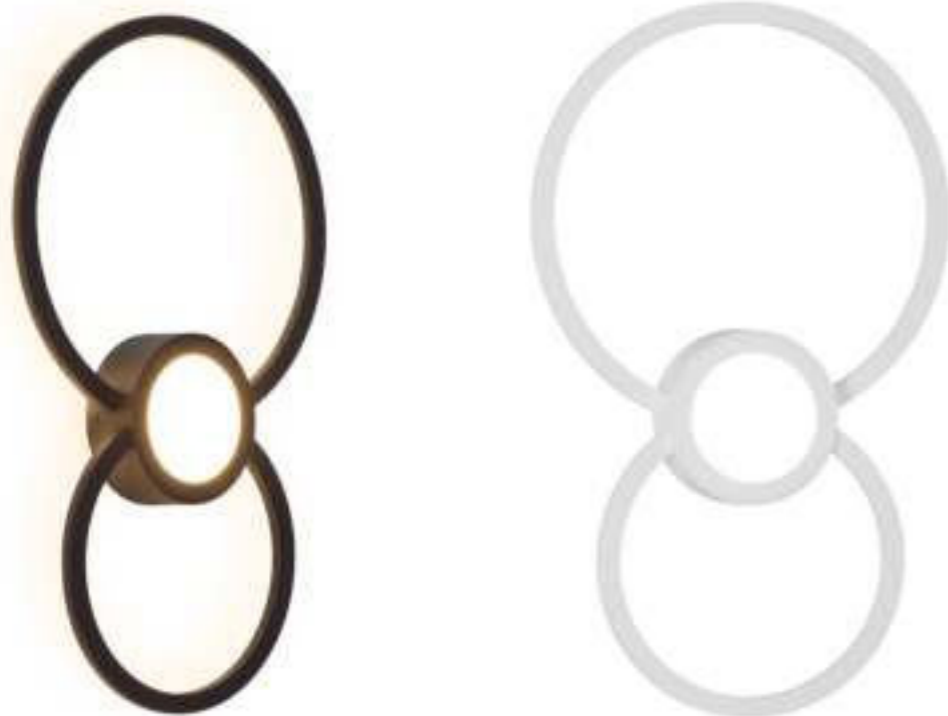
Indoor



REFERENCE	K	LED WATT	LUMENS	FINISH	INPUT	
6230	3000K	24W	1440lm	Blanco mate-Matt white	100-250V- 50/60Hz	On-off
7460	3000K	24W	1440lm	Negro mate-Matt black	100-250V- 50/60Hz	On-off
<b>New</b> 7540	3000K	24W	1440lm	Blanco mate-Matt white	220-240V- 50/60Hz	Dimmable 
<b>New</b> 7841	3000K	24W	1440lm	Negro mate-Matt black	220-240V- 50/60Hz	Dimmable 
					CRI ≥ 80	Aluminio-Aluminium

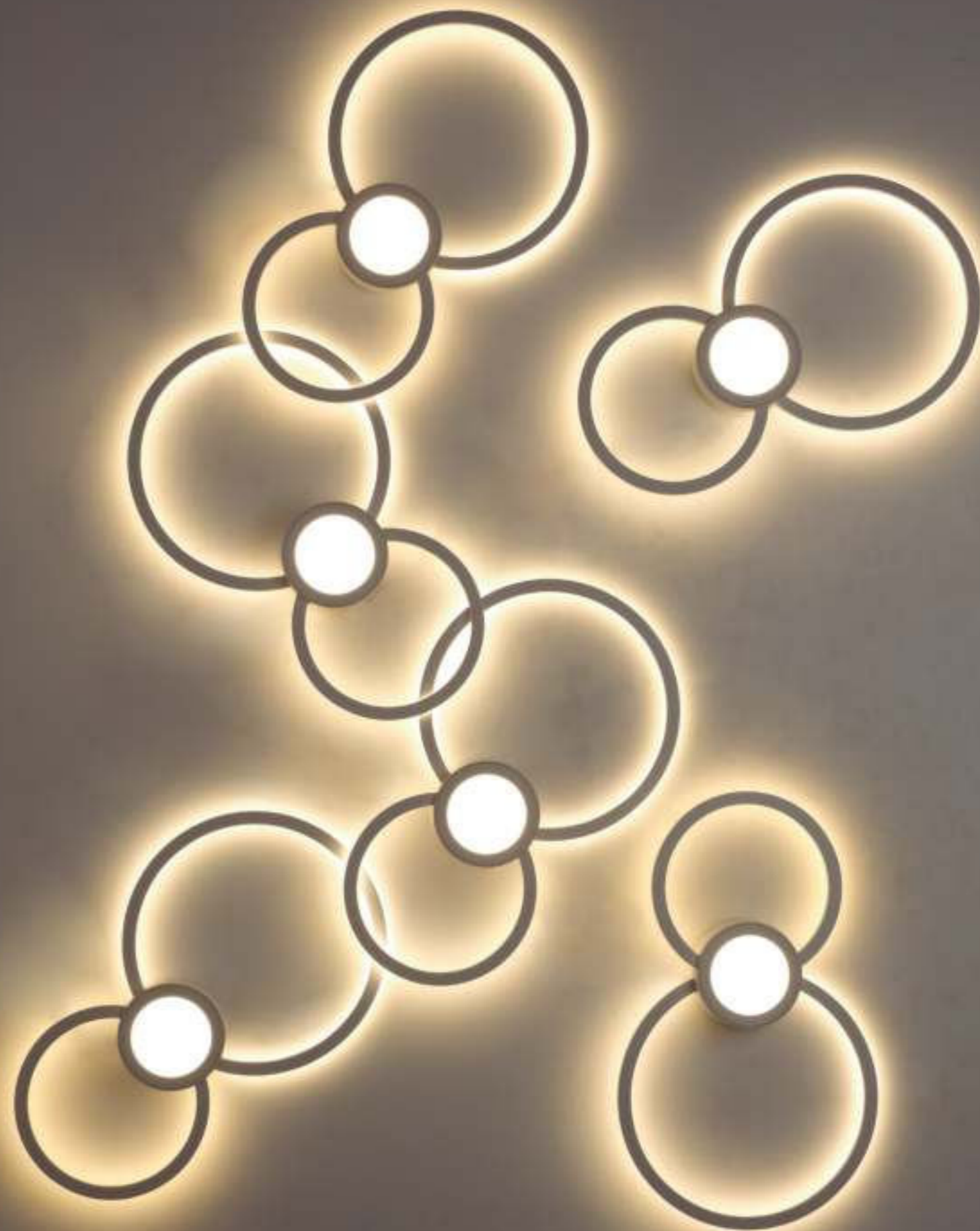
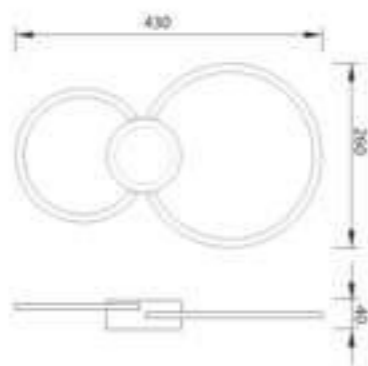





REFERENCE	K	LED WATT	LUMENS	FINISH
C0089	3000K	6W	215lm	Bianco mate-Matt white
		220-240V-50/60Hz	CRi > 80	Aluminio-Aluminium



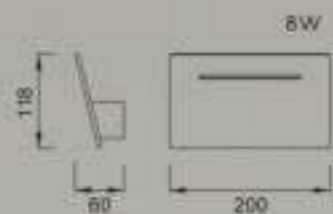
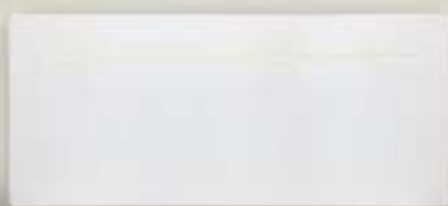

REFERENCE	K	LED WATT	LUMENS	FINISH
6253	3000K	8W	720lm	Blanco-White
5120	4000K	8W	720lm	Blanco-White
6254	3000K	16W	1410lm	Blanco-White
5121	4000K	16W	1410lm	Blanco-White
220-240V-50/60Hz CRI ≥ 80				Aluminio-Aluminium





REFERENCE	K	LED WATT	LUMENS	FINISH
6382	3000K	8W	619lm	Cuero-Antique brass
6380	3000K	8W	619lm	Cromo-Chrome
6383	3000K	12W	908lm	Cuero-Antique brass
6381	3000K	12W	908lm	Cromo-Chrome
6385	3000K	18W	1257lm	Cuero-Antique brass
6384	3000K	18W	1257lm	Cromo-Chrome
175-265V-50/60Hz CRI ≥ 80				Aluminio-Aluminium

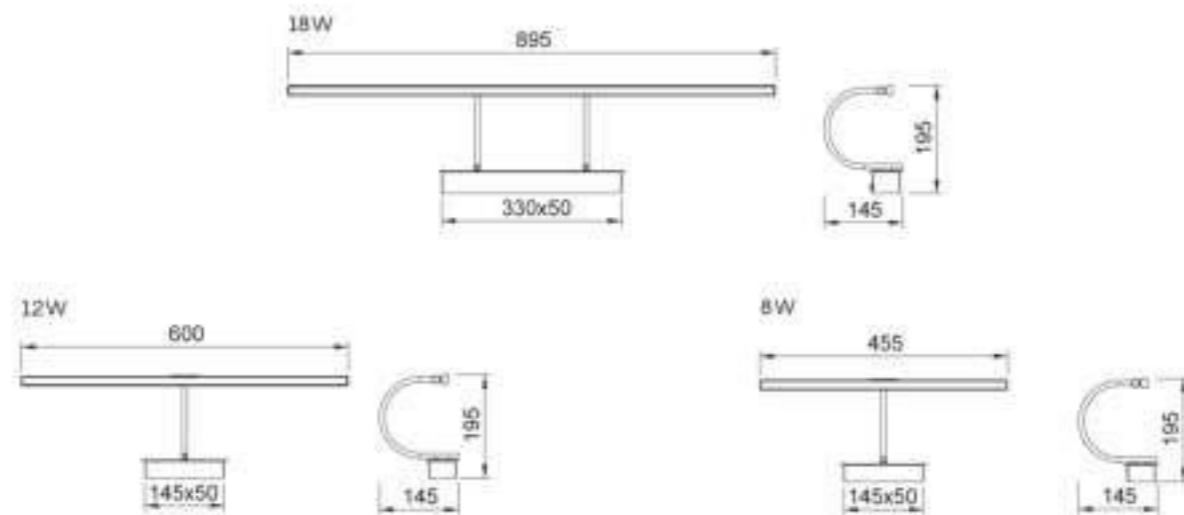

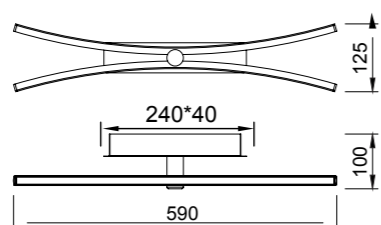
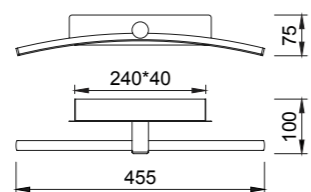

REFERENCE	K	LED WATT	LUMENS	FINISH
6370	3000K	8W	421lm	Cromo-Chrome
6374	3000K	24W	1497lm	Cromo-Chrome
175-265V ~50/60Hz CRI: ≥ 80				Aluminio-Aluminium



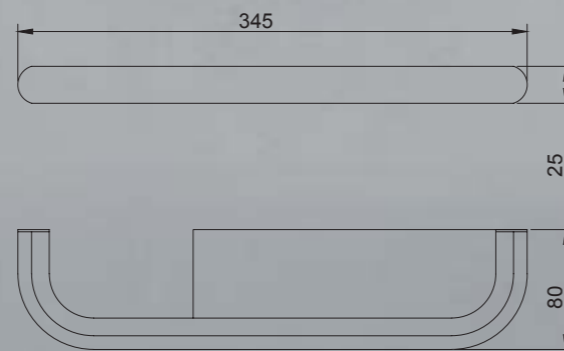

REFERENCE	K	LED WATT	LUMENS	FINISH
6870	3000K	8W	640lm	Blanco-White
6871	4000K	8W	680lm	Blanco-White
	+USB	100-250V~ 50/60Hz	CRi: ≥ 80	Acero/Silicona-Steel/Silicon





REFERENCE	K	LED WATT	LUMENS	FINISH
6875	3000K	18W	1400lm	Blanco-White
6876	3000K	18W	1400lm	Negro-Black
		+USB x 2	220-240V~ 50/60Hz CRI:≥ 80	Aluminio-Aluminium

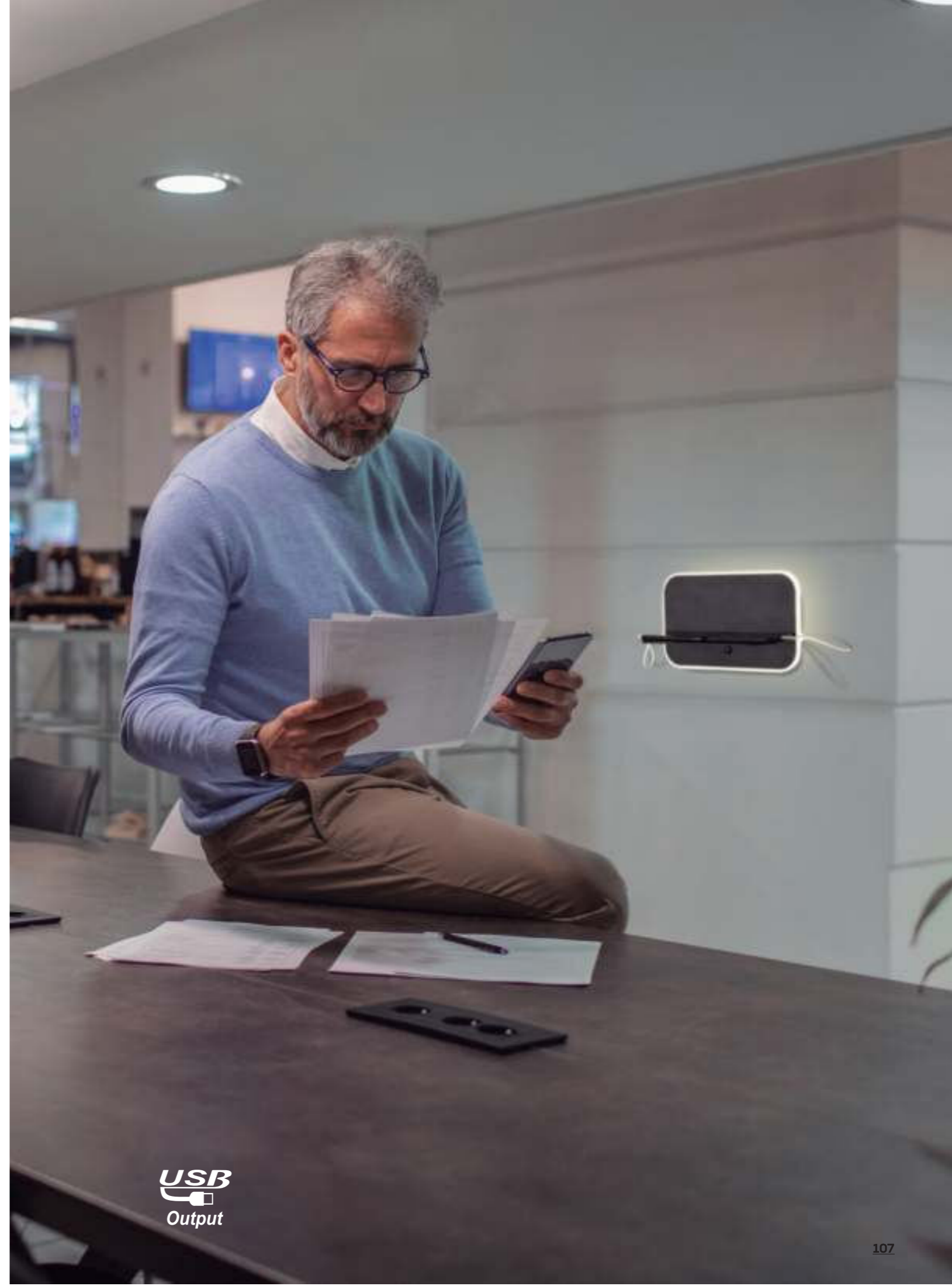
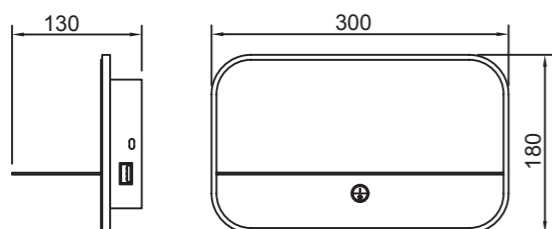

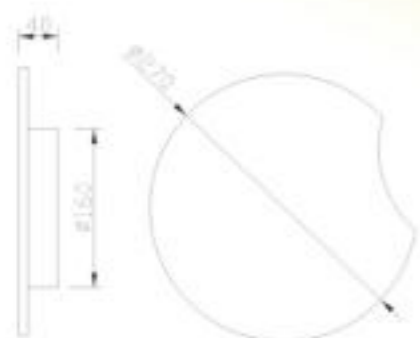
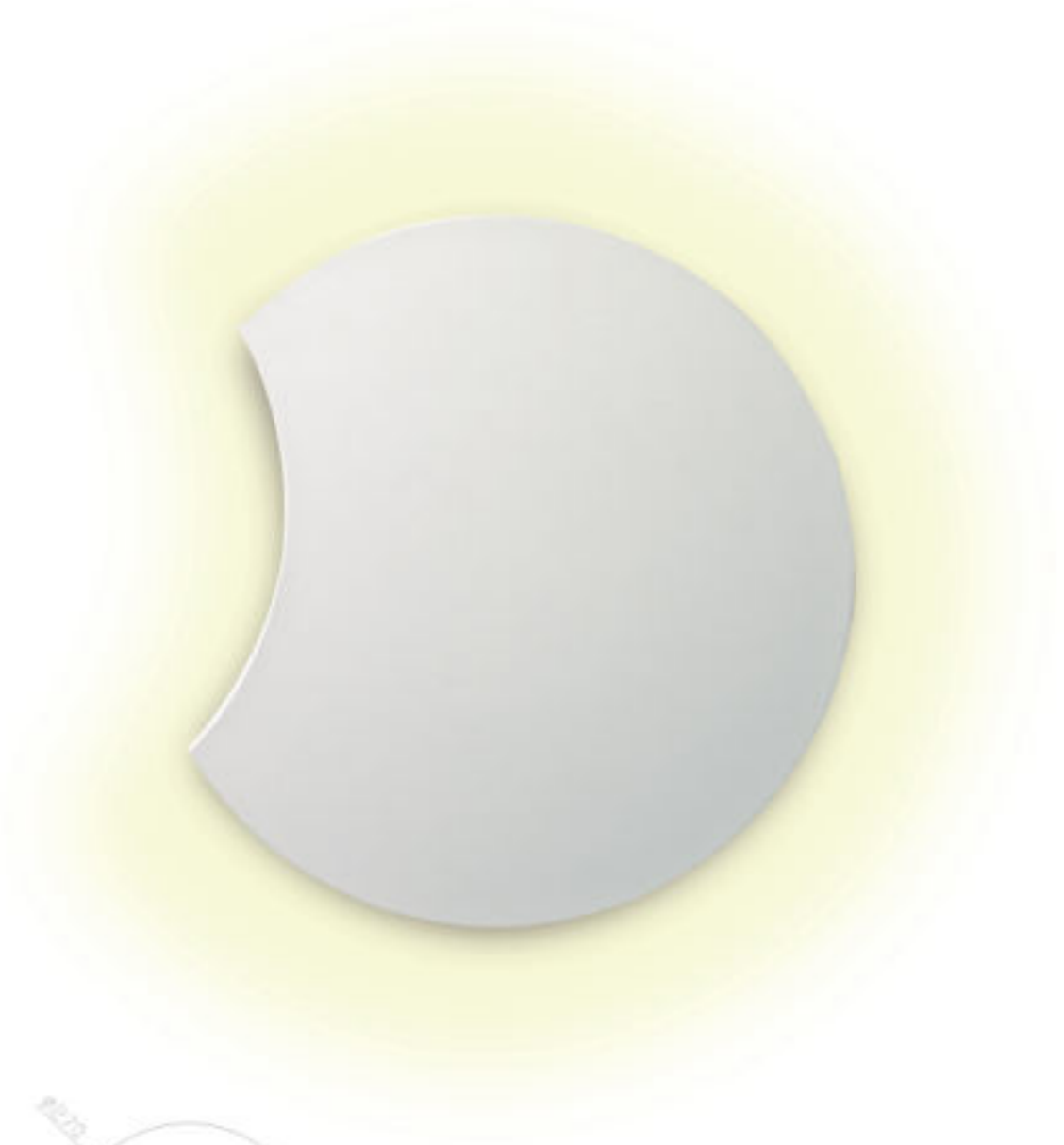

REFERENCE	K	LED WATT	LUMENS	FINISH
6043	3000K	16W	1350lm	Blanco mate - Matt white
220-240V - 50/60Hz CRI ≥ 80				Aluminio - Aluminium





7111



7110

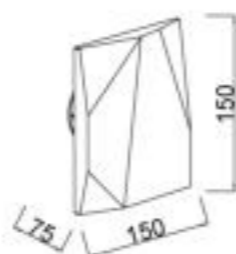
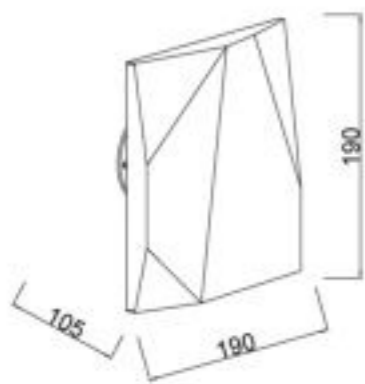

REFERENCE	K	LED WATT	LUMENS	FINISH
7110	3000K	10W	780lm	Blanco-White
7111	3000K	12,5W	975lm	Blanco-White
220-240V - 50/60Hz CRI: ≥ 80				Yeso-Gypsum

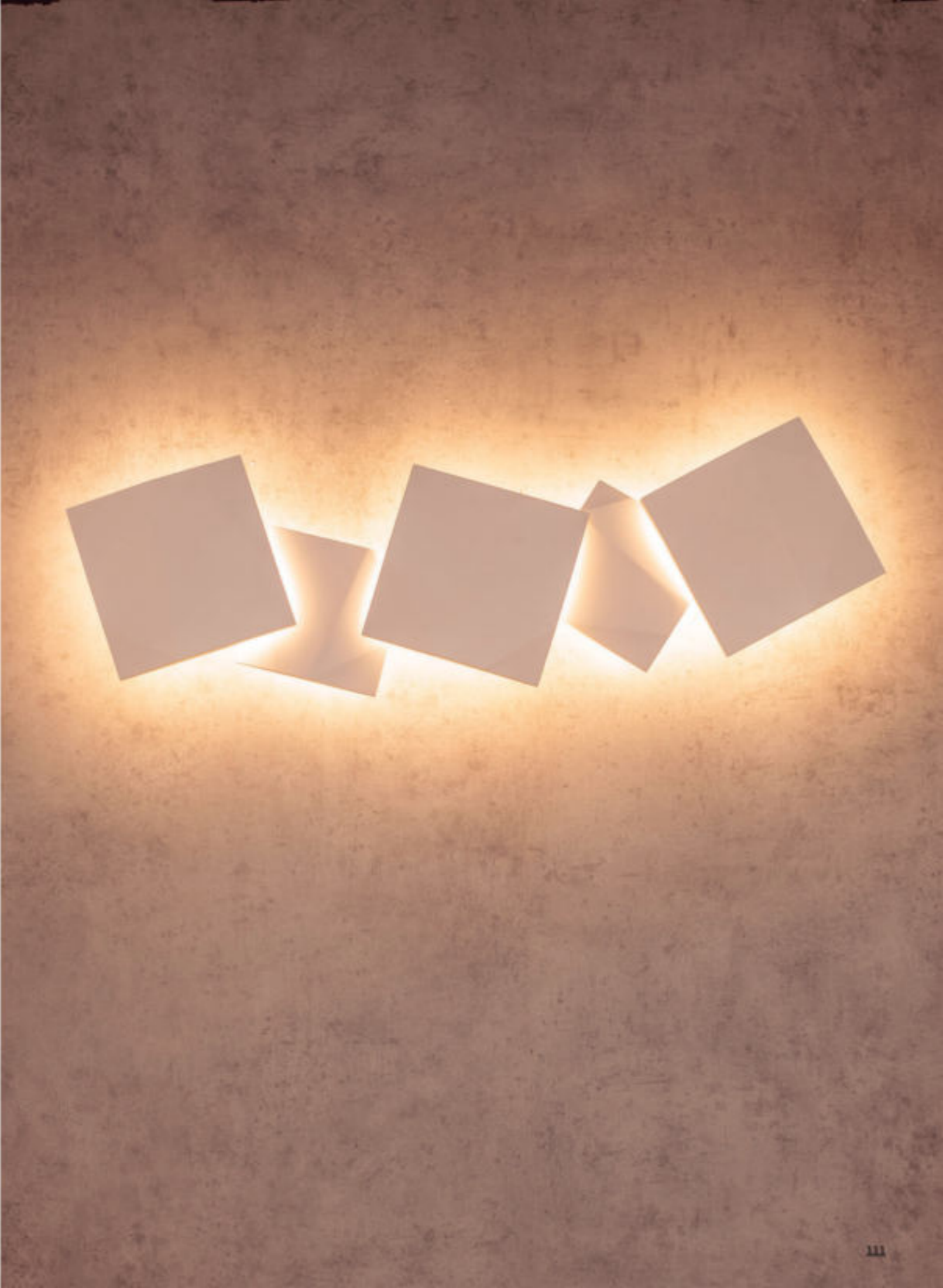



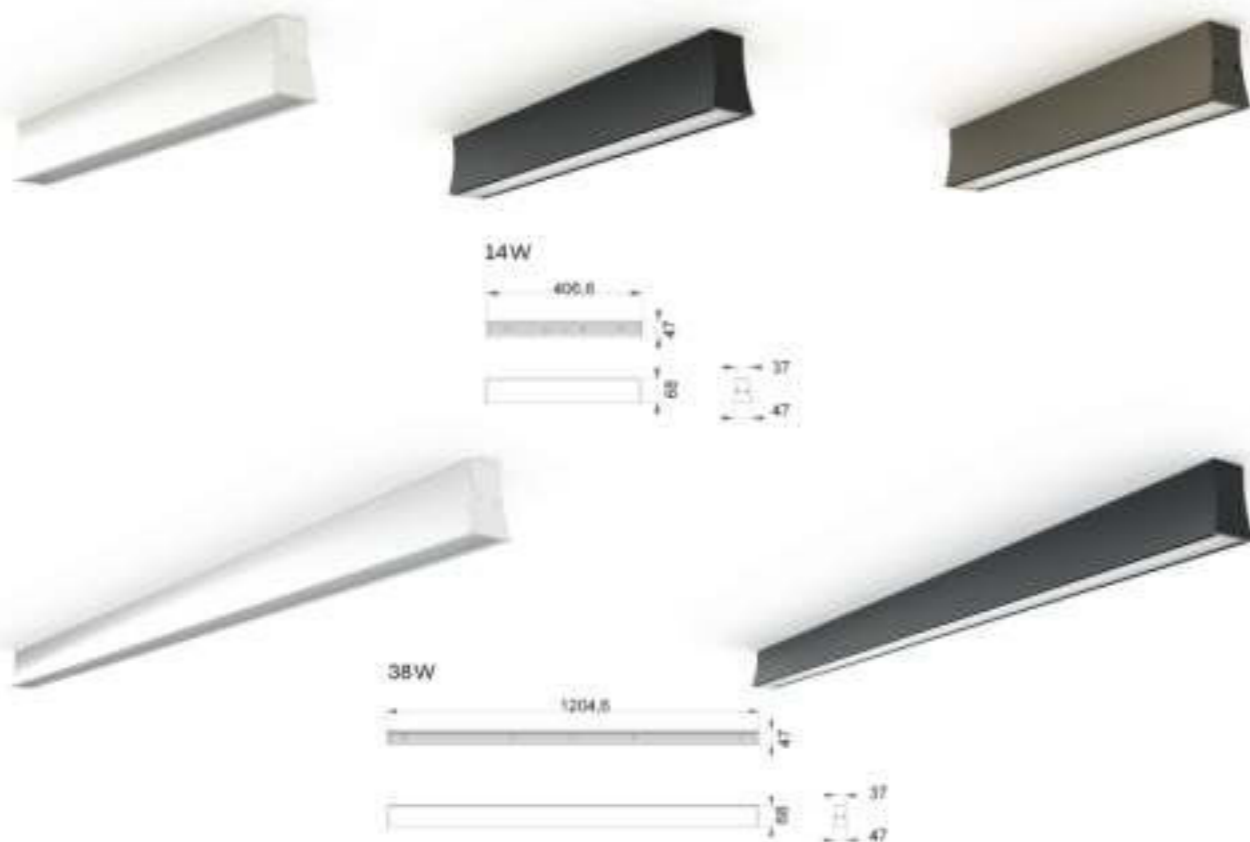

REFERENCE	K	LED WATT	LUMENS	FINISH
7949	3000K	14W	950lm	Blanco-White
7951	3000K	14W	950lm	Negro-Black
7953	3000K	14W	950lm	Arena-Sabbia
7950	4000K	14W	1000lm	Blanco-White
7952	4000K	14W	1000lm	Negro-Black
7945	3000K	38W	2850lm	Blanco-White
7947	3000K	38W	2850lm	Negro-Black
7946	4000K	38W	3000lm	Blanco-White
7948	4000K	38W	3000lm	Negro-Black

220-240V - 50/60Hz CRI: 80      Aluminio-Aluminium

7948 pág. 132    7953 pág. 24    7946 pág. 128



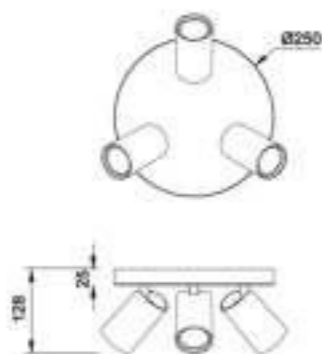

REFERENCE	BULB (No incl)	FINISH
7961	3L x GU10	Bianco mate-Matt white
7962	3L x GU10	Negra mate-Matt black
máx. 10W LED (No incl)		100-240V - 50/60Hz Aluminio-Aluminium



Bombillas recomendadas-Suggested bulbs

K	Wat LED	On/Off	Dimmable	Lumens
2700K	7W	R09254	R09257	510lm
3000K	7W	R09255	R09258	540lm
4000K	7W	R09256	R09259	570lm



# TORCH

Plafón-Ceiling lights

Indoor

360°

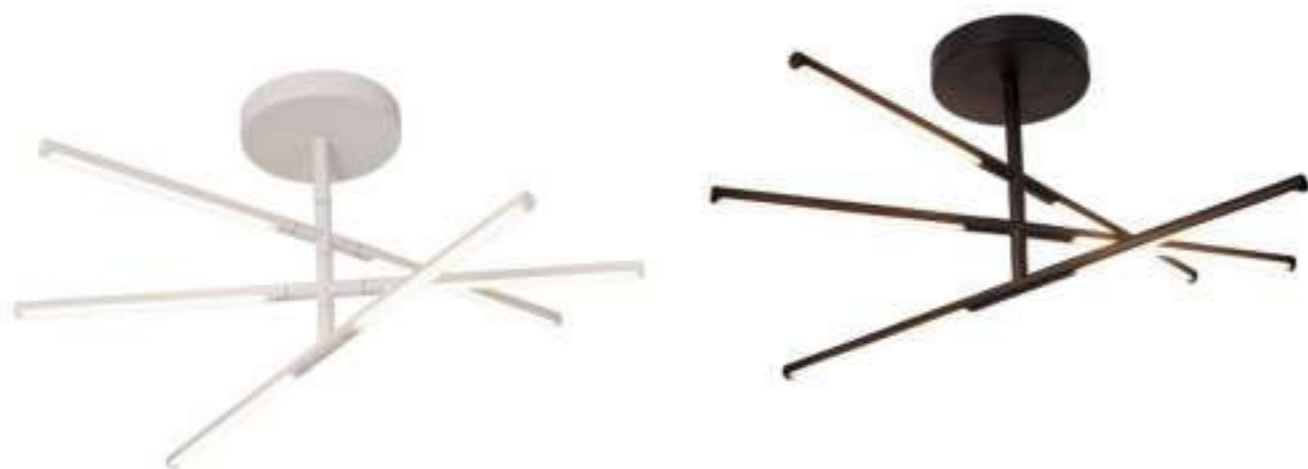

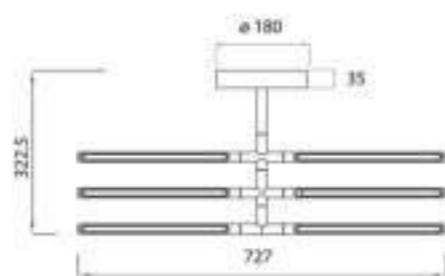

REFERENCE	K	LED WATT	LUMENS	FINISH
6827	3000K	36W	2850lm	Blanco arena-Sand white
6828	3000K	36W	2850lm	Negro arena-Sand black
		220-240V-50/60Hz	CRI: ≥ 80	Aluminio-Aluminium

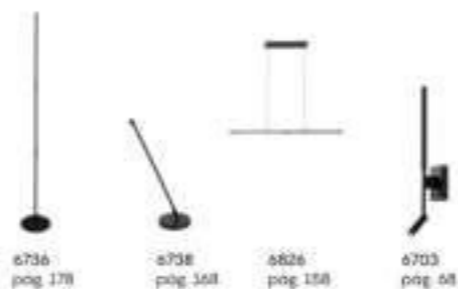

360°





REFERENCE	K	LED WATT	LUMENS	FINISH	
6560	3000K	48W	3840lm	Bianco mate-Matt white	On-off
6561	3000K	48W	3840lm	Bianco mate-Matt white	Dimmable 
7462	3000K	48W	3840lm	Negro-Black	On-off
7463	3000K	48W	3840lm	Negro-Black	Dimmable 
220-240V-50/60Hz CRI ≥ 80				Aluminio-Aluminum	

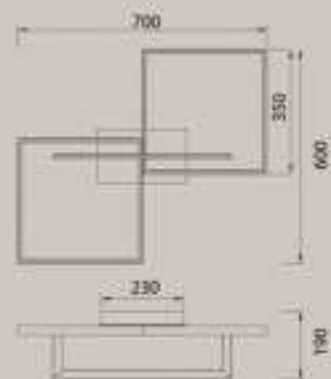

6230 pág 94



6562 pág 180



6562 pág 170





REFERENCE	BULB NO INCLUDED	FINISH
5410	5L • E27	Blanco-White
5411	3L • E27	Blanco-White
máx: 20W LED (No incl)		100-240V-50/60Hz Metal-Metal/Acrylic

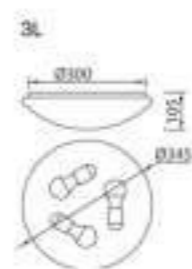
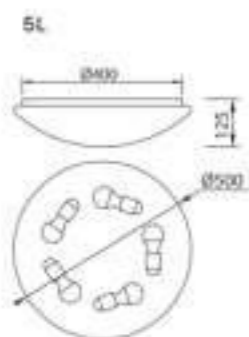



Downlight en superficie para paredes y soluciones sin falso techo.

REFERENCE	K	LED WATT	LUMENS	FINISH
6620	3000K	8W	680lm	Blanco mate-Matt white
6621	4000K	8W	720lm	Blanco mate-Matt white
6622	3000K	14W	1190lm	Blanco mate-Matt white
6623	4000K	14W	1260lm	Blanco mate-Matt white
6624	3000K	24W	2040lm	Blanco mate-Matt white
6625	4000K	24W	2160lm	Blanco mate-Matt white
6626	3000K	30W	2550lm	Blanco mate-Matt white
6627	4000K	30W	2700lm	Blanco mate-Matt white
220-240V~50/60Hz CRI≥ 80				Aluminio-Aluminium

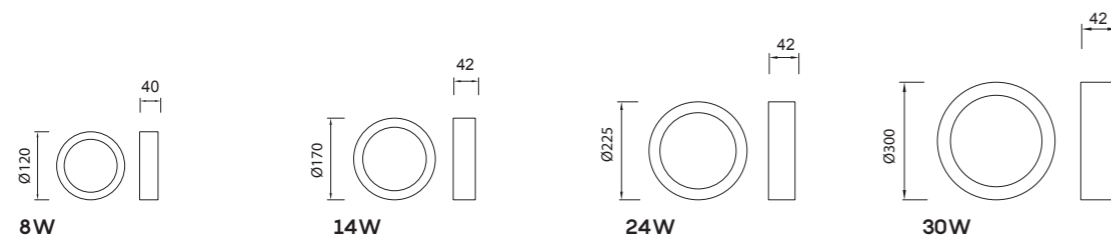

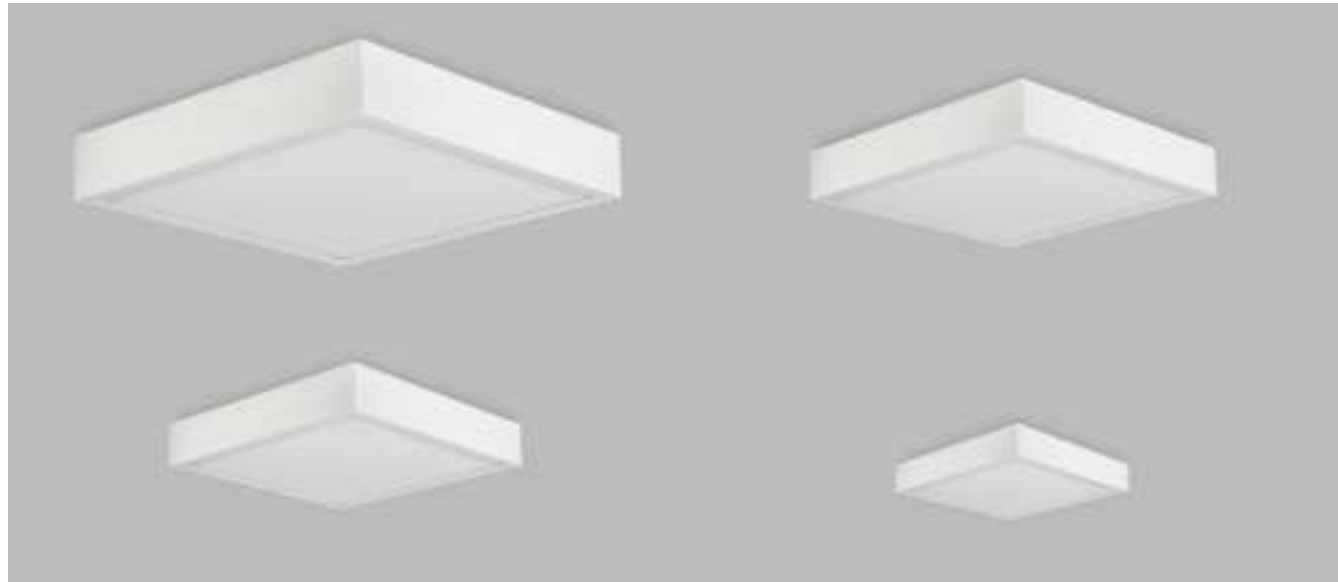

Downlight en superficie para paredes y soluciones sin falso techo.

REFERENCE	K	LED WATT	LUMENS	FINISH
6628	3000K	8W	680lm	Blanco mate-Matt white
6629	4000K	8W	720lm	Blanco mate-Matt white
6630	3000K	14W	1190lm	Blanco mate-Matt white
6631	4000K	14W	1260lm	Blanco mate-Matt white
6632	3000K	24W	2040lm	Blanco mate-Matt white
6633	4000K	24W	2160lm	Blanco mate-Matt white
6634	3000K	30W	2550lm	Blanco mate-Matt white
6635	4000K	30W	2700lm	Blanco mate-Matt white
220-240V~50/60Hz CRI≥ 80				Aluminio-Aluminium

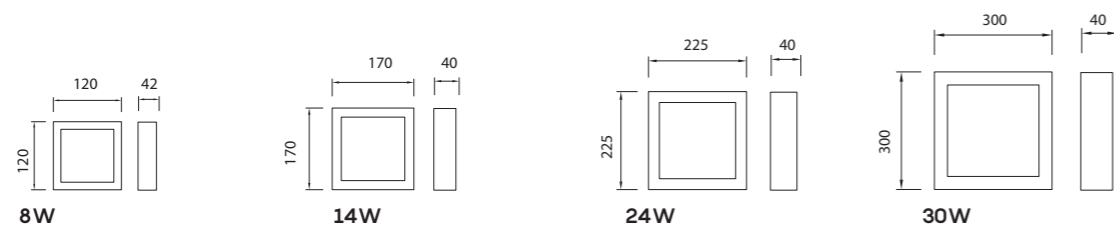

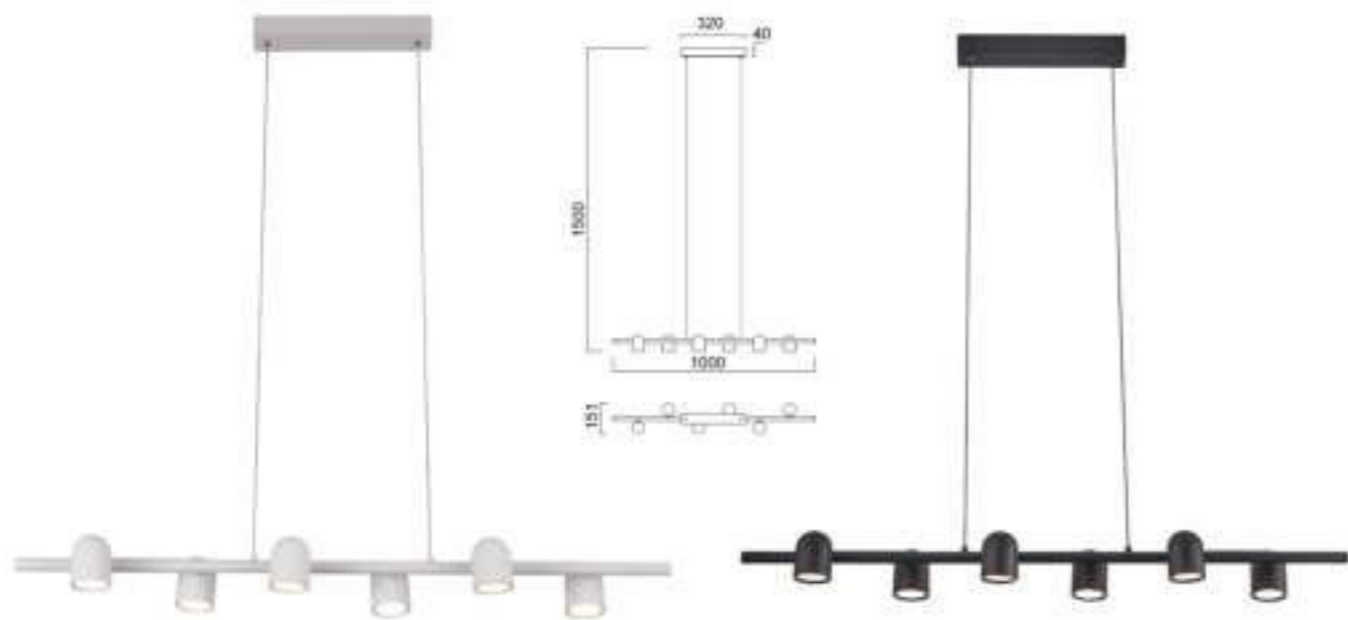

REFERENCE	BULB (No incl)	FINISH
7936	6L x GU10	Blanco-White
7937	6L x GU10	Negro-Black
máx. 12W LED (No incl)		100-240V - 50/60Hz Aluminio-Aluminium



7936 pag 184



Bombillas recomendadas-Suggested bulbs

K	Wat LED	On/Off	Dimmable	Lumens
2700K	7W	R09254	R09257	510lm
3000K	7W	R09255	R09258	540lm
4000K	7W	R09256	R09259	570lm





# HANOK

by David Vilalba

Lámpara lineal-Linear lamp

Indoor



REFERENCE	K	LED WATT	LUMENS	FINISH
7542	3000K	38W	2850lm	Blanca-White
7546	3000K	38W	2850lm	Negra-Black
7569	3000K	38W	2850lm	Arena-Sabbia
7543	4000K	38W	3000lm	Blanca-White
7547	4000K	38W	3000lm	Negra-Black
On-off		220-240V - 50/60Hz CRi: 80		Aluminio-Aluminium

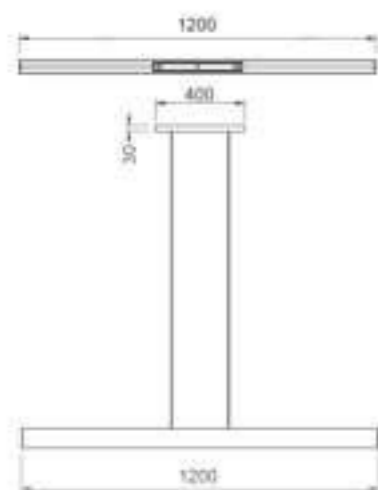

# HANOK

by David Villalba

Lámpara lineal-Linear lamp

Indoor



REFERENCE	K	LED WATT	LUMENS	FINISH
7540	3000K	38W	2650lm	Blanco-White
7544	3000K	38W	2650lm	Negro-Black
7541	4000K	38W	2600lm	Blanco-White
7545	4000K	38W	2600lm	Negro-Black
UGR<16		220-240V- 50/60Hz CRI: 90		Aluminio-Aluminium

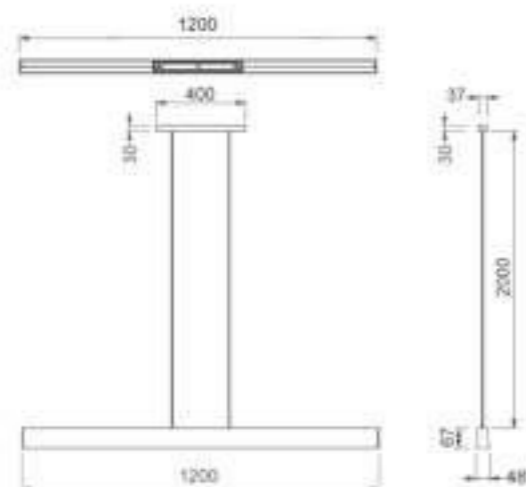

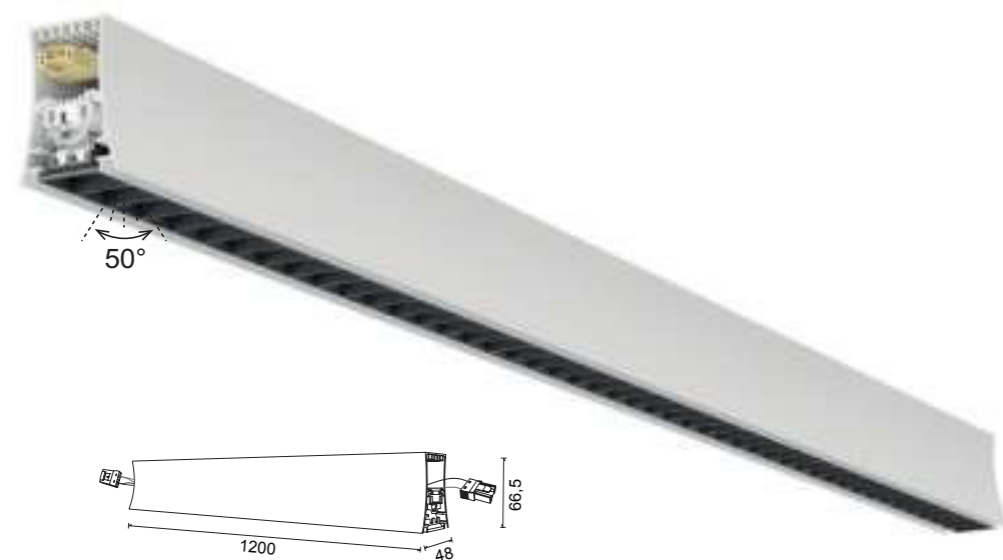

REFERENCE	K	LED WATT	LUMENS	FINISH
7548	3000K	38W	2650lm	Blanco-White
7549	4000K	38W	2800lm	Blanco-White
	UGR<16	220-240V~ 50/60Hz	CRI≥ 80	Aluminio-Aluminium

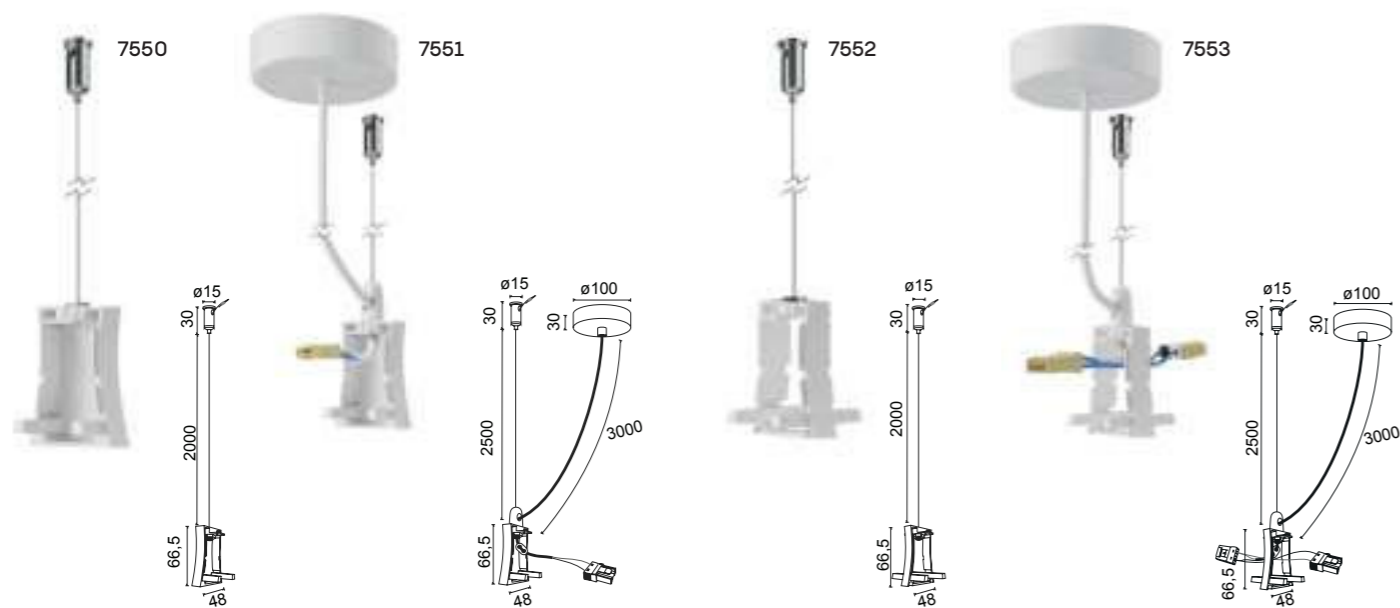

REFERENCE

7550	Tapa lateral con cable fijación-Side cover white with fixing wire
7551	Tapa lateral con cable alimentación y florón-Side cover white with ac wire & rosette
7552	Conexión intermedia con cable fijación-Middle connection white with fixing wire
7553	Conexión intermedia con cable alimentación y florón - Middle connection white with ac wire & rosette



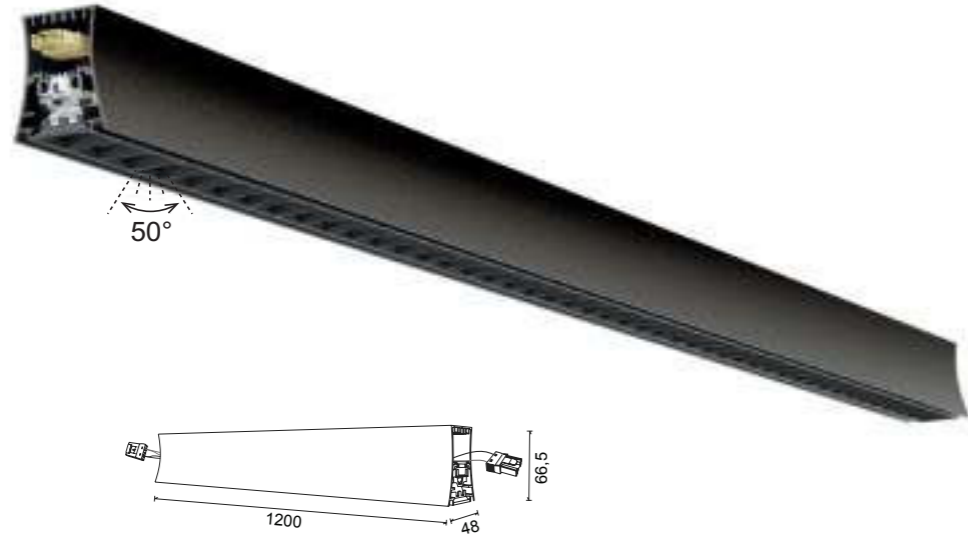

REFERENCE	K	LED WATT	LUMENS	FINISH
7554	3000K	38W	2650lm	Negro-Black
7555	4000K	38W	2800lm	Negro-Black
	UGR<16	220-240V~ 50/60Hz	CRI≥ 80	Aluminio-Aluminium

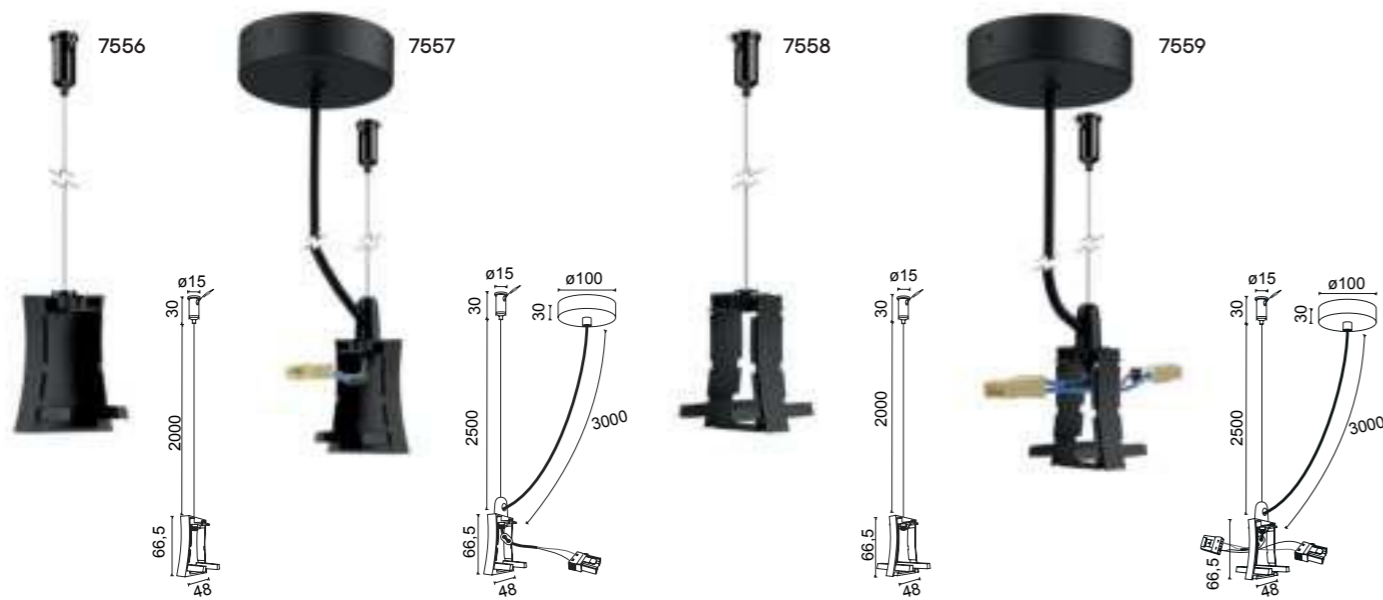

REFERENCE	DESCRIPTION
7556	Tapa lateral con cable fijación-Side cover white with fixing wire
7557	Tapa lateral con cable alimentación y florón-Side cover white with ac wire & rosette
7558	Conexión intermedia con cable fijación-Middle connection white with fixing wire
7559	Conexión intermedia con cable alimentación y florón - Middle connection white with ac wire & rosette



# PAGODA

by David Villalba

Colgante-Pendant lamp

Indoor  
UGR<16

CRI≥90

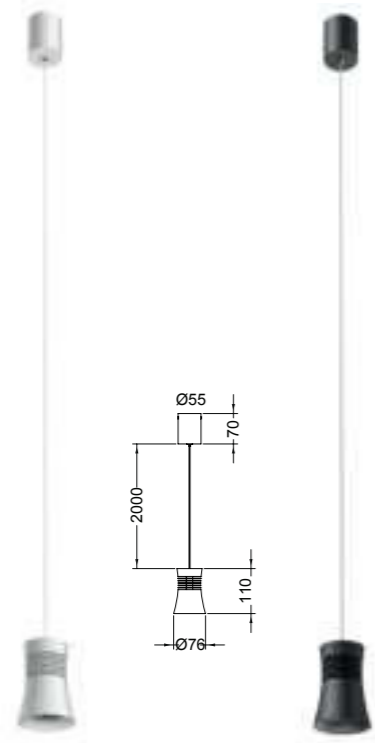

REFERENCE	K	LED WATT	LUMENS	FINISH
7784	3000K	12,5W	950lm	Blanco-White
7786	3000K	12,5W	950lm	Negro-Black
7785	4000K	12,5W	1050lm	Blanco-White
7787	4000K	12,5W	1050lm	Negro-Black
UGR<16		220-240V~ 50/60Hz	CRI:≥ 90	Aluminio-Aluminium



7788  
pág. 204



# PAGODA

by David Villalba

Colgante - Pendant lamp

Indoor



REFERENCE	BULB (No incl)	FINISH
7790	1L x GU10	Blanco-White
7791	1L x GU10	Negro-Black
máx. 12W LED (No incl)		100-240V - 50/60Hz Aluminio-Aluminium



Bombillas recomendadas - Suggested bulbs

K	Watt LED	On/Off	Dimmable	Lumens
2700K	7W	R09254	R09257	510lm
3000K	7W	R09255	R09258	540lm
4000K	7W	R09256	R09259	570lm



# ORION

by Hugo Tejada

Lámpara de techo - Pendant lamp

Indoor



REFERENCE	K	LED WATT	LUMENS	FINISH
7475	3000K	24W	1770 lm	Negro/cuero-Black/antique brass
		220-240V - 50/60Hz CR> 80		Aluminio/Acrílico-Aluminium/Acrylic

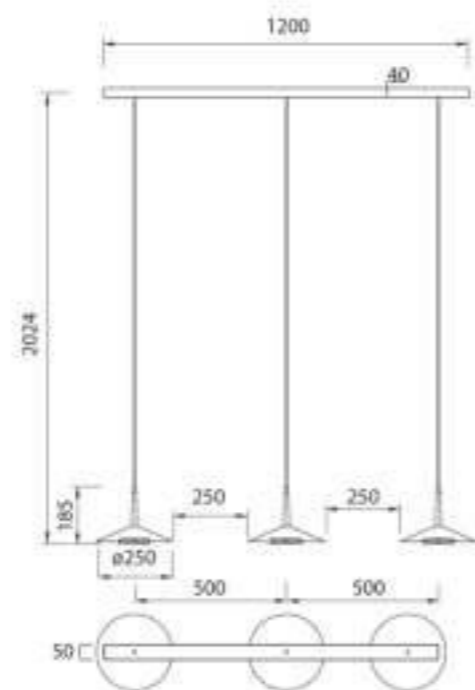

**ORION**  
by Hugo Tejada

Lámpara de techo-Pendant lamp

Indoor

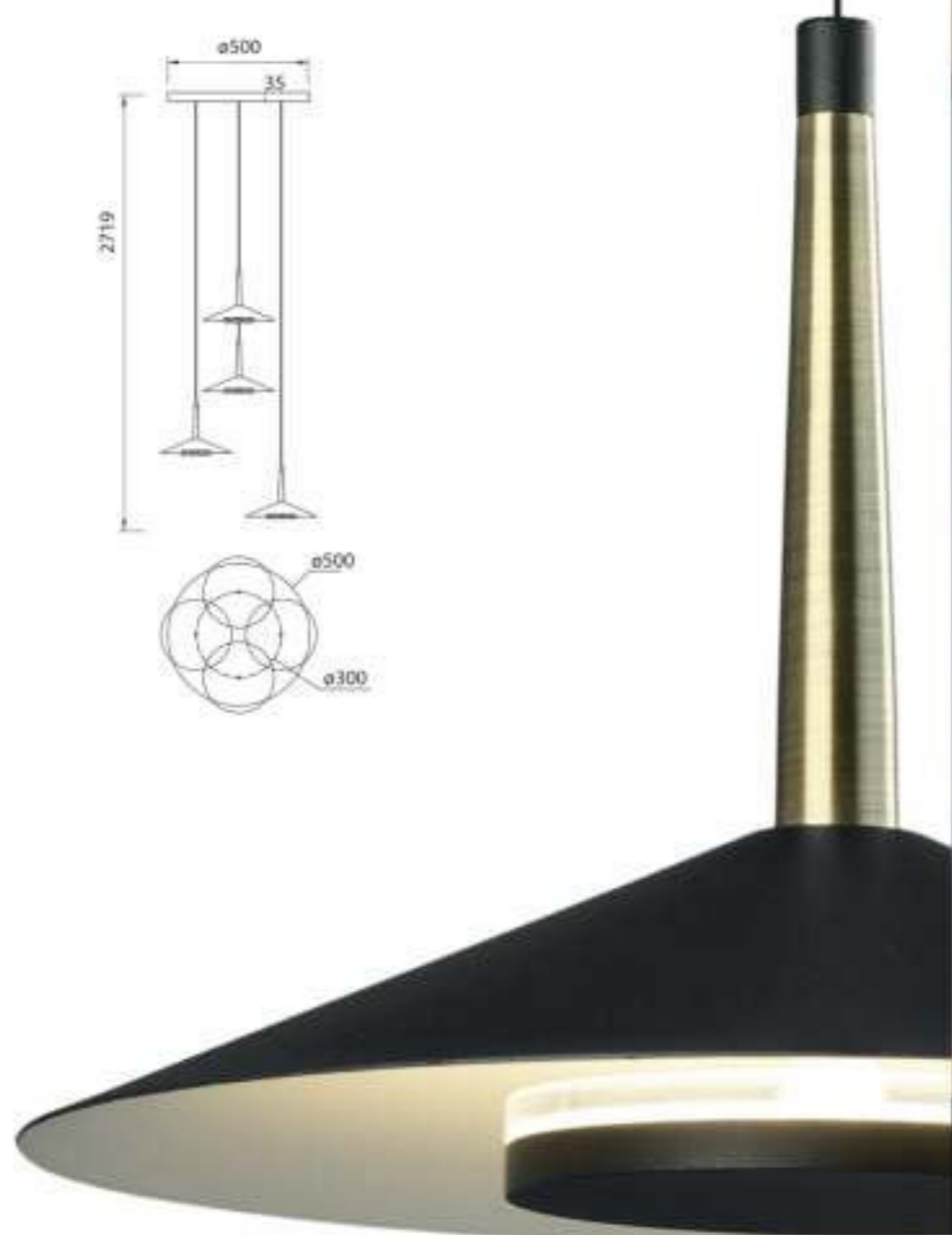
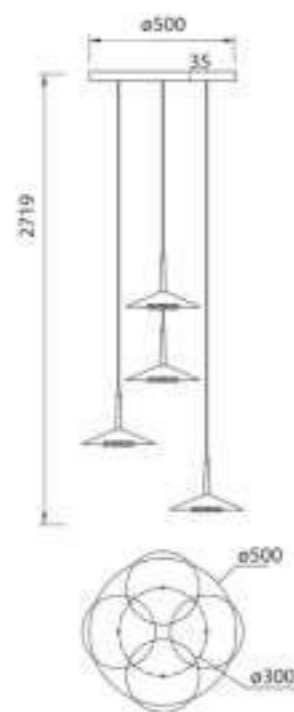

REFERENCE	K	LED WATT	LUMENS	FINISH
7476	3000K	32W	2360lm	Negro/cuero-Black/antique brass
		220-240V - 50/60Hz CRI: 80 Aluminio/Acrílico-Aluminium/Acrylic		



8128  
pág 16





**ORION**  
by Hugo Tejada

Lámparas de techo - Pendant lamp

Indoor

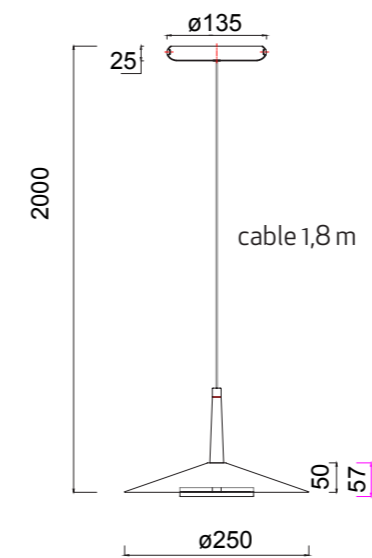

REFERENCE	K	LED WATT	LUMENS	FINISH
7305	3000K	8W	590lm	Negro/cuero-Black/antique brass
		220-240V ~ 50/60Hz	CRI ≥ 80	Aluminio/Acrílico-Aluminium/Acrylic



Registered N° 007663331-0014

DRIVER  
**TÜV**

**ORION**  
by Hugo Tejada

Lámparas de techo-Pendant lamp

Indoor



REFERENCE	K	LED WATT	LUMENS	FINISH
7306	3000K	16W	1180lm	Negro/cuero-Black/antique brass
	6 und	reference 7308	included	Blocacables-WireLocker
		220-240V - 50/60Hz CRI: 80		Aluminio/Acrílico-Aluminium/Acrylic

7308 Blocacables-WireLocker 1 und

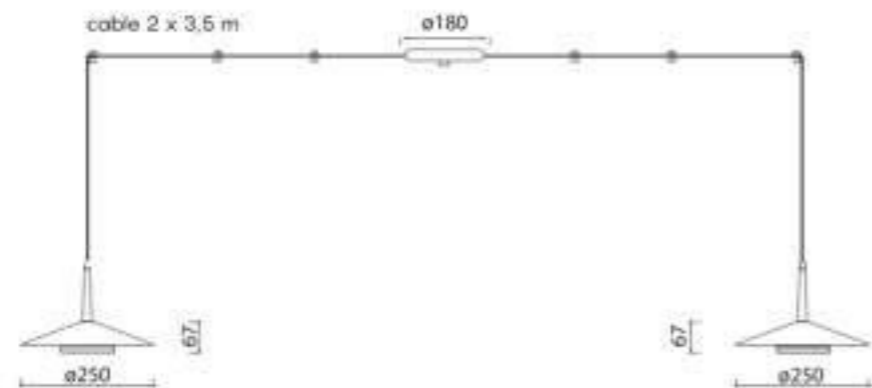

# ORION

by Hugo Tejada

Lámparas de techo-Pendant lamp

Indoor



REFERENCE	K	LED WATT	LUMENS	FINISH
7307	3000K	32W	2360lm	Negro/cuero-Black/antique brass
	12 und	reference 7308	included	Blocacables-WireLocker
		220-240V~ 50/60Hz CRI≥ 80		Aluminio/Acrílico-Aluminium/Acrylic

7308 Blocacables-WireLocker 1 und

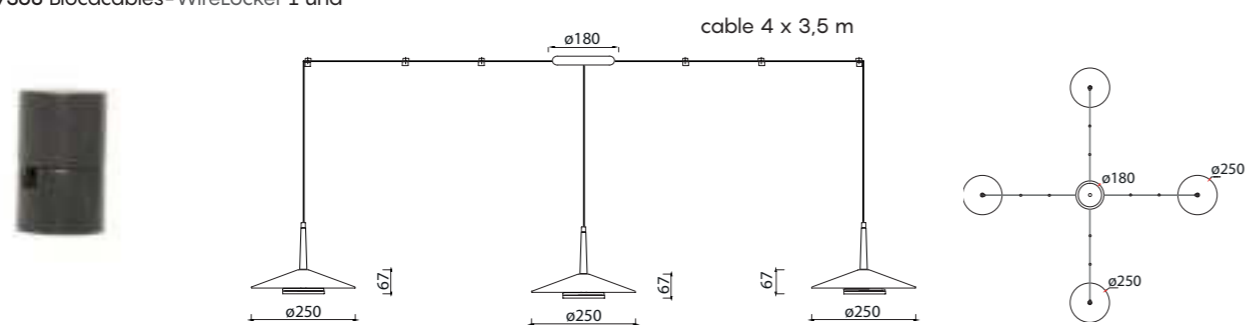

DRIVER  
TÜV

Registered N° 007663331-0014

**SIRIO**  
by Hugo Tejada

Lámparas de techo-Pendant lamp

Indoor

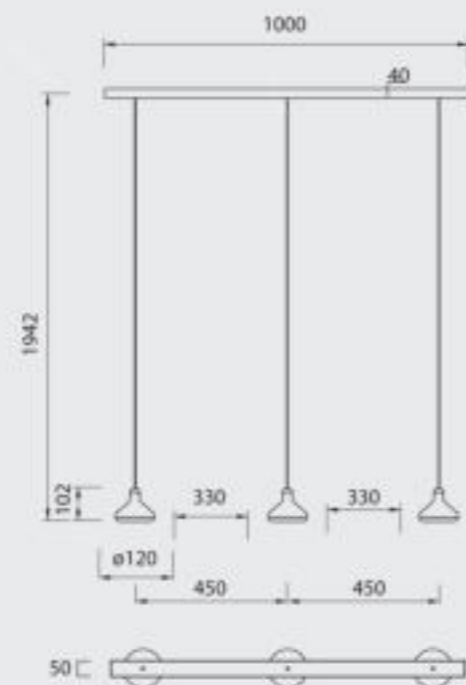

REFERENCE	K	LED WATT	LUMENS	FINISH
7312	3000K	24W	1770lm	Negra-Black
220-240V - 50/60Hz CRI: 80 Aluminio/Acrílico - Aluminium/Acrylic				



**SIRIO**  
by Hugo Tejada

Indoor



Lámparas de techo-Pendant lamp



REFERENCE	K	LED WATT	LUMENS	FINISH
7313	3000K	32W	2360lm	Negro-Black
		220-240V - 50/60Hz	CRi > 80	Aluminio/Acrílico-Aluminium/Acrylic

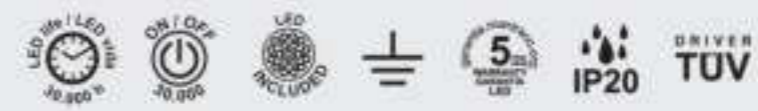

# SIRIO

by Hugo Tejada

Lámparas de techo-Pendant lamp

Indoor



cable 1,8 m



REFERENCE	K	LED WATT	LUMENS	FINISH
7310	3000K	8W	590lm	Negro-Black
		220-240V~ 50/60Hz CRI≥ 80 Aluminio/Acrílico-Aluminium/Acrylic		



DRIVER  
TUV

Registered N° 007663331-0010

**SIRIO**  
by Hugo Tejada

Lámparas de techo - Pendant lamp

Indoor



REFERENCE	K	LED WATT	LUMENS	FINISH
7311	3000K	24W	1770lm	Negro-Black
220-240V - 50/60Hz CRI: 80 Aluminio/Acrílico - Aluminium/Acrylic				



cables 6 x 1,8 m

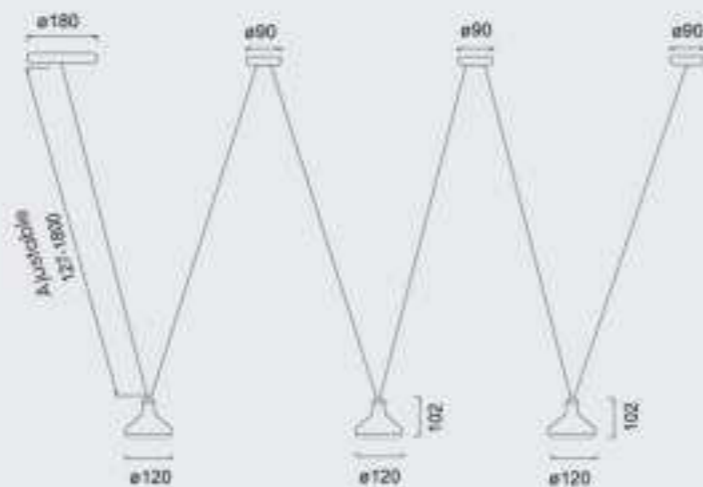



REFERENCE	K	LED WATT	LUMENS	FINISH
6825	3000K	21W	1475lm	Blanco Mate-Matt white
6826	3000K	21W	1475lm	Negro Mate-Matt black
220-240V- 50/60Hz CRI: 80				Aluminio-Aluminium

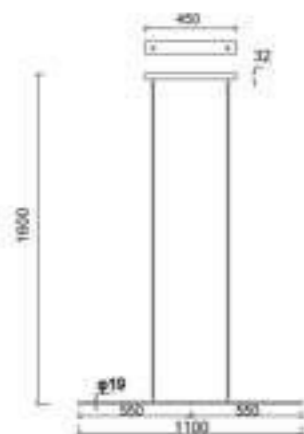



REFERENCE	BULB NO INCLUDED	FINISH	DIAMETER (ø):
5622	1L • E27	Blanco mate-Matt White	ø 120
5624	1L • E27	Plata-Silver	ø 120
5623	1L • E27	Blanco mate-Matt White	ø 95
5625	1L • E27	Plata-Silver	ø 95
máx. 20W LED (No incl)		100-240V-50/60Hz Metal-Metal	

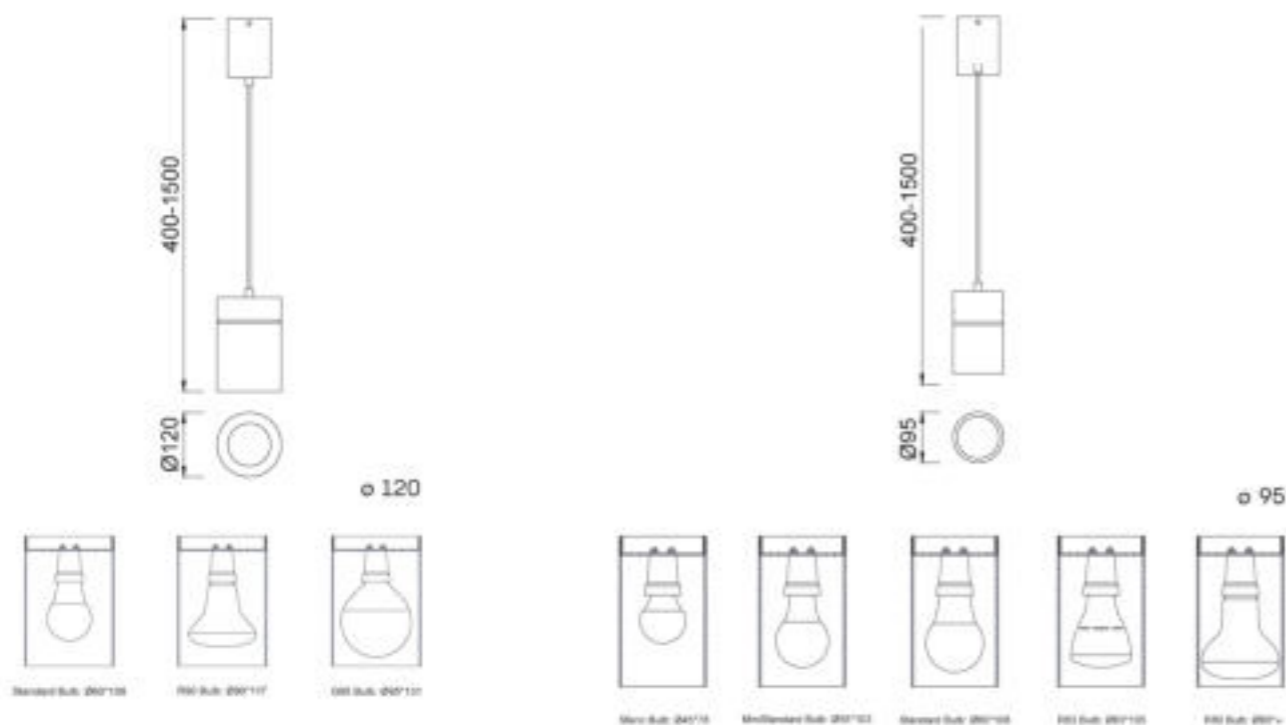

6044  
pág. 208

6015  
pág. 190



# FLORÓN empotrable

Base empotrada para colgantes - Recessed base for pendants

Indoor



REFERENCE	FINISH
New 7855	Blanca-White
New 7856	Negra-Black
New 7857	Plata-Silver
New 7858	Oro-Gold
New 7859	Cuero-Antique Brass
	Hierro-Iron

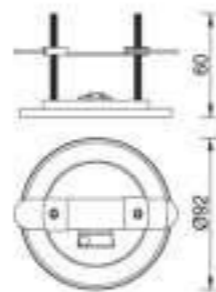



REFERENCE	BULB (No incl)	FINISH
7520	1L x GU10	Bianco arena-Sand white
7521	1L x GU10	Bianco arena-Sand white
7515	1L x GU10	Negro mate-Matt black
7516	1L x GU10	Negro mate-Matt black

max. 10W LED (No incl) 100-240V - 50/60Hz Aluminio-Aluminium

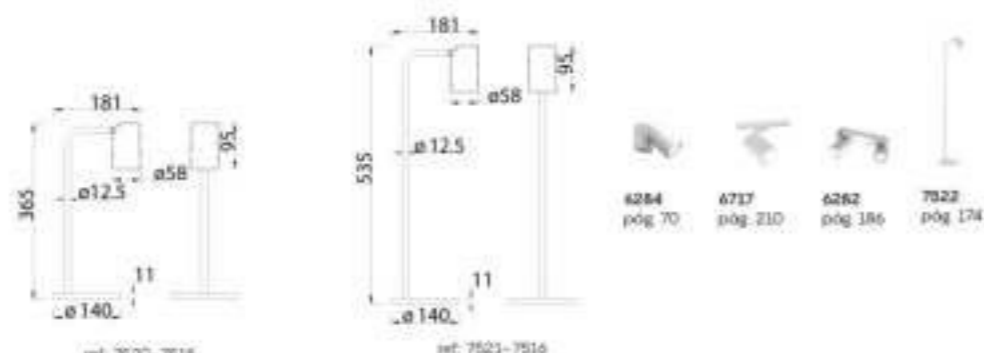

Bombillas recomendadas-Suggested bulbs

K	Wat LED	On/Off	Dimmable	Lumens
2700K	7W	R09254	R09257	510lm
3000K	7W	R09255	R09258	540lm
4000K	7W	R09256	R09259	570lm





7511



7510

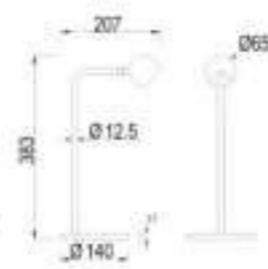

REFERENCE	K	LED WATT	LUMENS	FINISH
7510	3000K	6W	390lm	Negro arena-Sand black
7511	3000K	6W	390lm	Negro arena-Sand black
220-240V- 50/60Hz CRI: > 80				Aluminio-Aluminium



7512  
pág 176

7513  
pág 94



# TORCH

Sobremesa-Table lamp

Indoor

360°



REFERENCE	K	LED WATT	LUMENS	FINISH
6737	3000K	11W	900lm	Bianco mate-Matt white
6738	3000K	11W	900lm	Negro mate-Matt black
220-240V- 50/60Hz CRt≥ 80				Aluminio-Aluminium

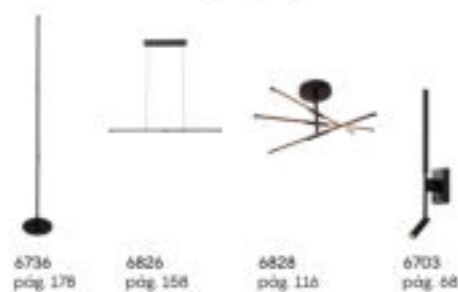

6736 pág. 178  
6826 pág. 158  
6828 pág. 116  
6703 pág. 58



ErP COMPLIANT DRIVER TÜV RoHS



REFERENCE	K	LED WATT	LUMENS	FINISH
7464	3000K	18W	1380lm	Negro-Black
100-240V-50/60Hz CRI > 80 Aluminium/Iron/Acrílico-Aluminium/Iron/Acrylic				



REFERENCE	K	LED WATT	LUMENS	FINISH
6562	3000K	18W	1380lm	Blanco-White
100-240V-50/60Hz CRI > 80 Aluminium/Iron/Acrílico-Aluminium/Iron/Acrylic				

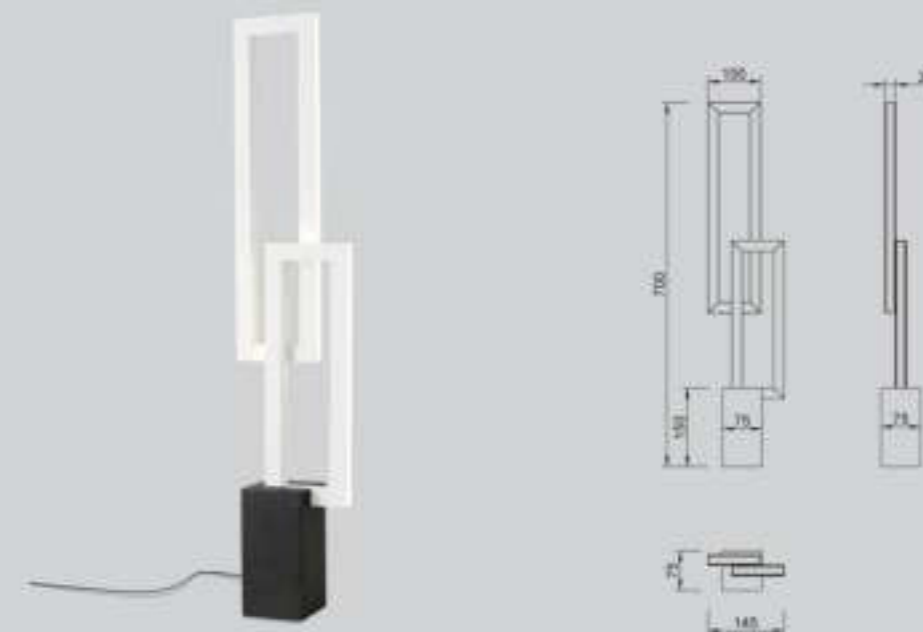

6560/0561  
pág. 118





Touch  
switch  
3 Step-Dim



\* Cargador De Inducción Teléfono-Cell Phone Induction Charger

REFERENCE	K	LED WATT	LUMENS	FINISH
6715	3000K	6W	450lm	Blanco-White
6716	3000K	6W	450lm	Negra-Black
		220-240V - 50/60Hz	CRI: ≥ 80	Aluminio/Metal-Aluminium/Metal



6754  
pág 58



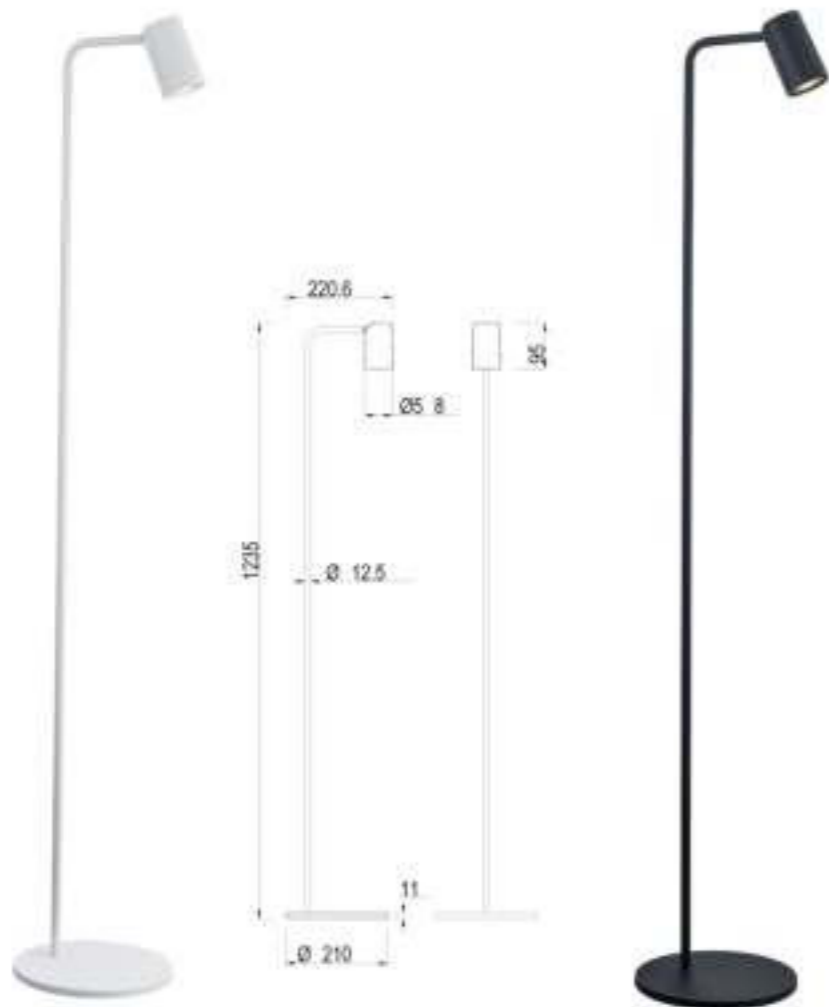

REFERENCE	BULB (No incl)	FINISH
7522	1L x GU10	Blanco arena-Sand white
7517	1L x GU10	Negro mate-Matt black
máx. 10W LED (No incl)		100-240V-50/60Hz Acrílico-Acrylic



6281  
pág 185



6284  
pág 70



6717  
pág 210



7520  
pág 164



Bombillas recomendadas-Suggested bulbs

K	Watt LED	On/Off	Dimmable	Lumens
2700K	7W	R09254	R09257	510lm
3000K	7W	R09255	R09258	540lm
4000K	7W	R09256	R09259	570lm







REFERENCE	K	LED WATT	LUMENS	FINISH
7512	3000K	6W	390lm	Negro arena-Sand black
		220-240V ~ 50/60Hz CRI:≥ 80		Aluminio-Aluminium



# TORCH

Pie de Solón-Floor lamp

360°

Indoor



REFERENCE	K	LED WATT	LUMENS	FINISH
6735	3000K	25W	1950lm	Bianco mate-Matt white
6736	3000K	25W	1950lm	Negro mate-Matt black
220-240V - 50/60Hz CRI ≥ 80				Aluminio-Aluminium

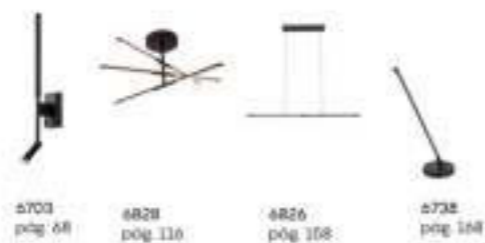

# MURAL

Pie de Salón-Floor lamp

Indoor

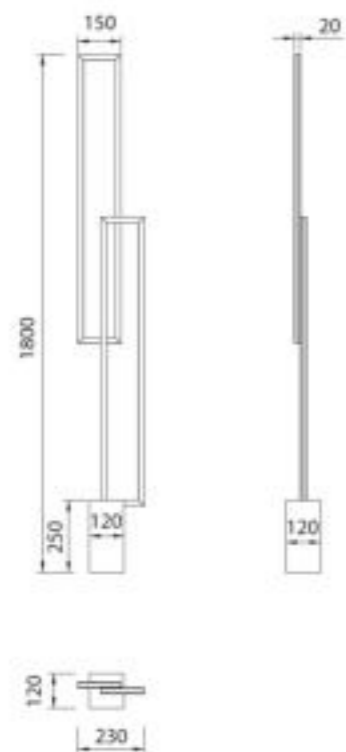

REFERENCE	K	LED WATT	LUMENS	FINISH
7465	3000K	48W	3800lm	Negro-Black
220-240V-50/60Hz CRI: ≥ 80 Aluminium/Iron/Acrílico-Aluminium/Iron/Acrylic				

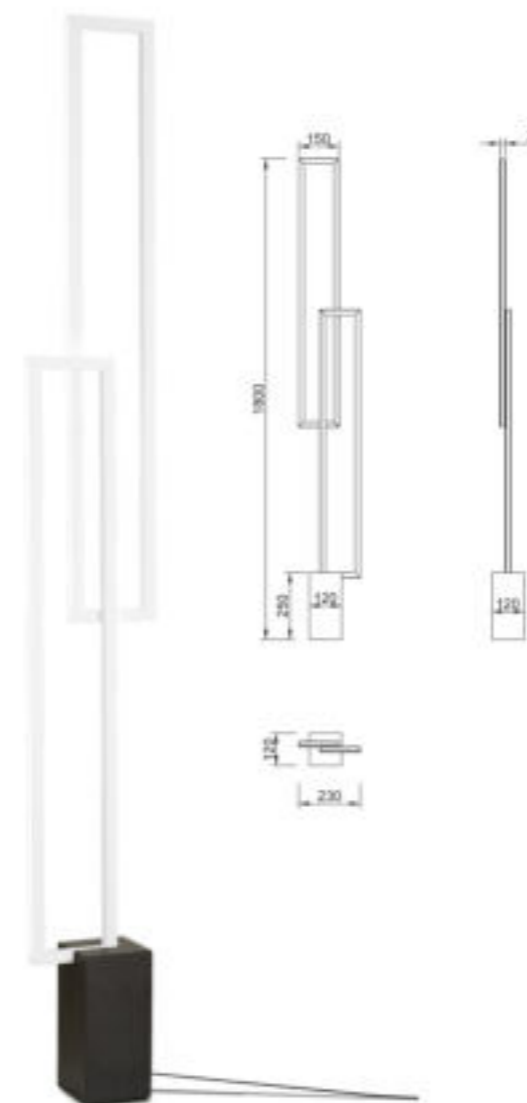

REFERENCE	K	LED WATT	LUMENS	FINISH
6563	3000K	48W	3800lm	Bianco-White
220-240V-50/60Hz CRI: ≥ 80 Aluminium/Iron/Acrílico-Aluminium/Iron/Acrylic				



# GLACIAR

by Santiago Sevillano

Indoor



REFERENCE	K	LED WATT	LUMENS	FINISH	SIZES
7730	3000K	9W	700lm	Blanco-White	100
7731	4000K	9W	700lm	Blanco-White	100
7732	3000K	9W	700lm	Blanco-White	170
7733	4000K	9W	700lm	Blanco-White	170
7734	3000K	9W	700lm	Blanco-White	240
7735	4000K	9W	700lm	Blanco-White	240
				220-240V ~ 50/60Hz CRI ≥ 80	Acrílico-Arcylic

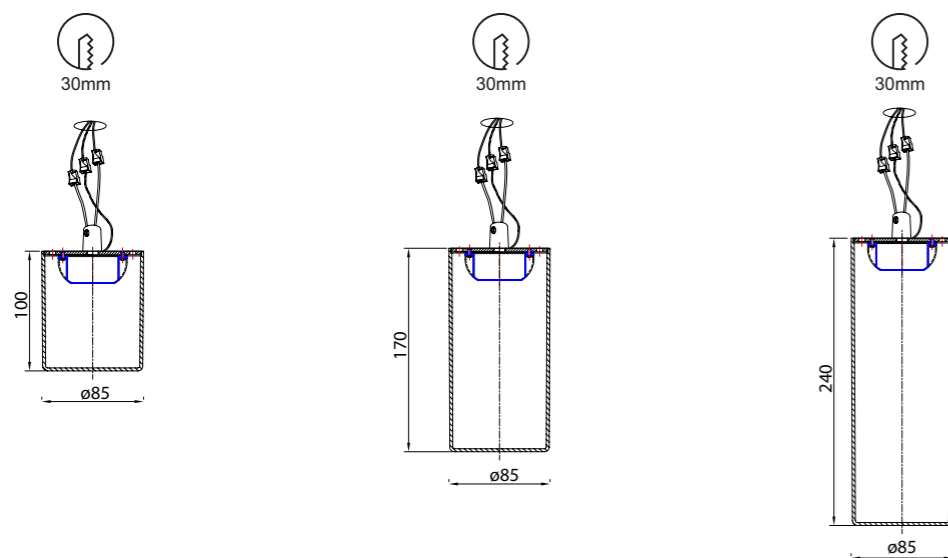

# IOS

by Hugo Tejada

Indoor

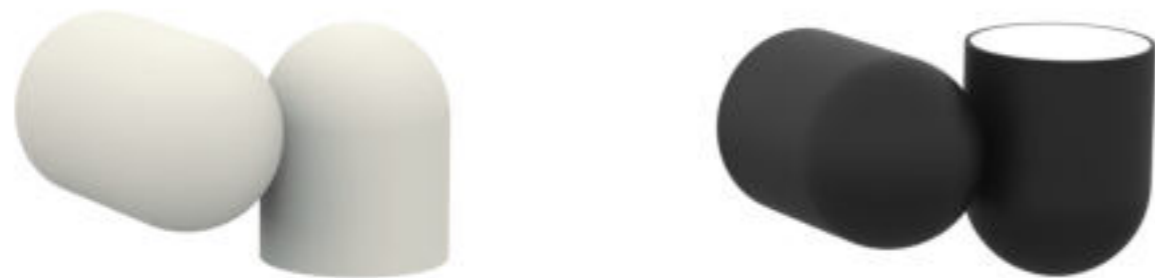

REFERENCE	BULB (No incl)	FINISH
7294	1L x GU10	Blanco-White
7295	1L x GU10	Negro-Black
máx. 12W LED (No incl) 100-240V-50/60Hz Aluminio-Aluminium		



Bombillas recomendadas - Suggested bulbs

K	Watt LED	On/Off	Dimmable	Lumens
2700K	7W	R09254	R09257	510lm
3000K	7W	R09255	R09258	540lm
4000K	7W	R09256	R09259	570lm



Registered N° 007663331-0013



7937  
pág. 126

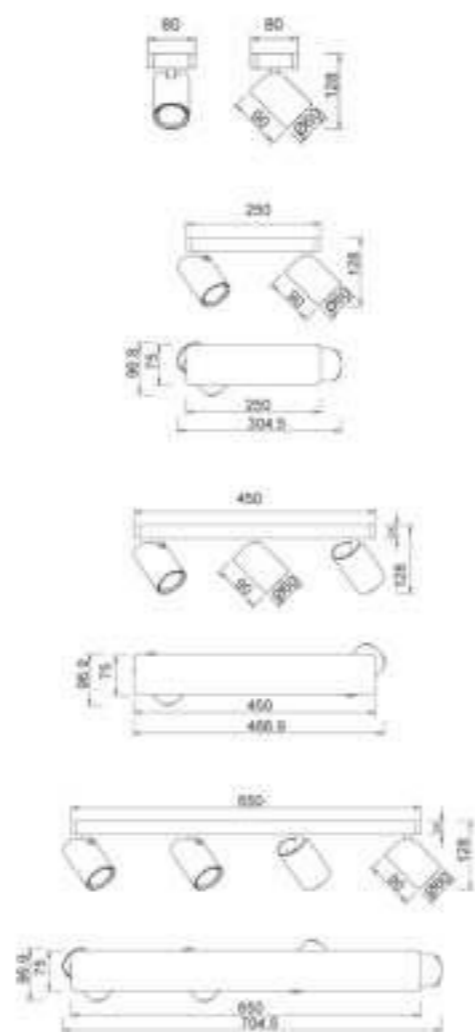

REFERENCE	BULB (No incl)	FINISH
6283	1L x GU10	Bianco mate-Matt white
6713	1L x GU10	Negro mate-Matt black
6282	2L x GU10	Bianco mate-Matt white
6712	2L x GU10	Negro mate-Matt black
6281	3L x GU10	Bianco mate-Matt white
6711	3L x GU10	Negro mate-Matt black
6280	4L x GU10	Bianco mate-Matt white
6710	4L x GU10	Negro mate-Matt black

máx. 10W LED (No incl) 100-240V - 50/60Hz Aluminio-Aluminium



# GOWER

Indoor



REFERENCE	K	LED WATT	LUMENS	FINISH
6830	3000K	7W	520lm	Bianco arena-Sand white
6833	3000K	7W	520lm	Negro arena-Sand black
6832	4000K	7W	560lm	Bianco arena-Sand white
6831	4000K	7W	560lm	Negro arena-Sand black
220-240V - 50/60Hz CRI: > 80				Aluminio-Aluminum

C Plane Distribution Diagram

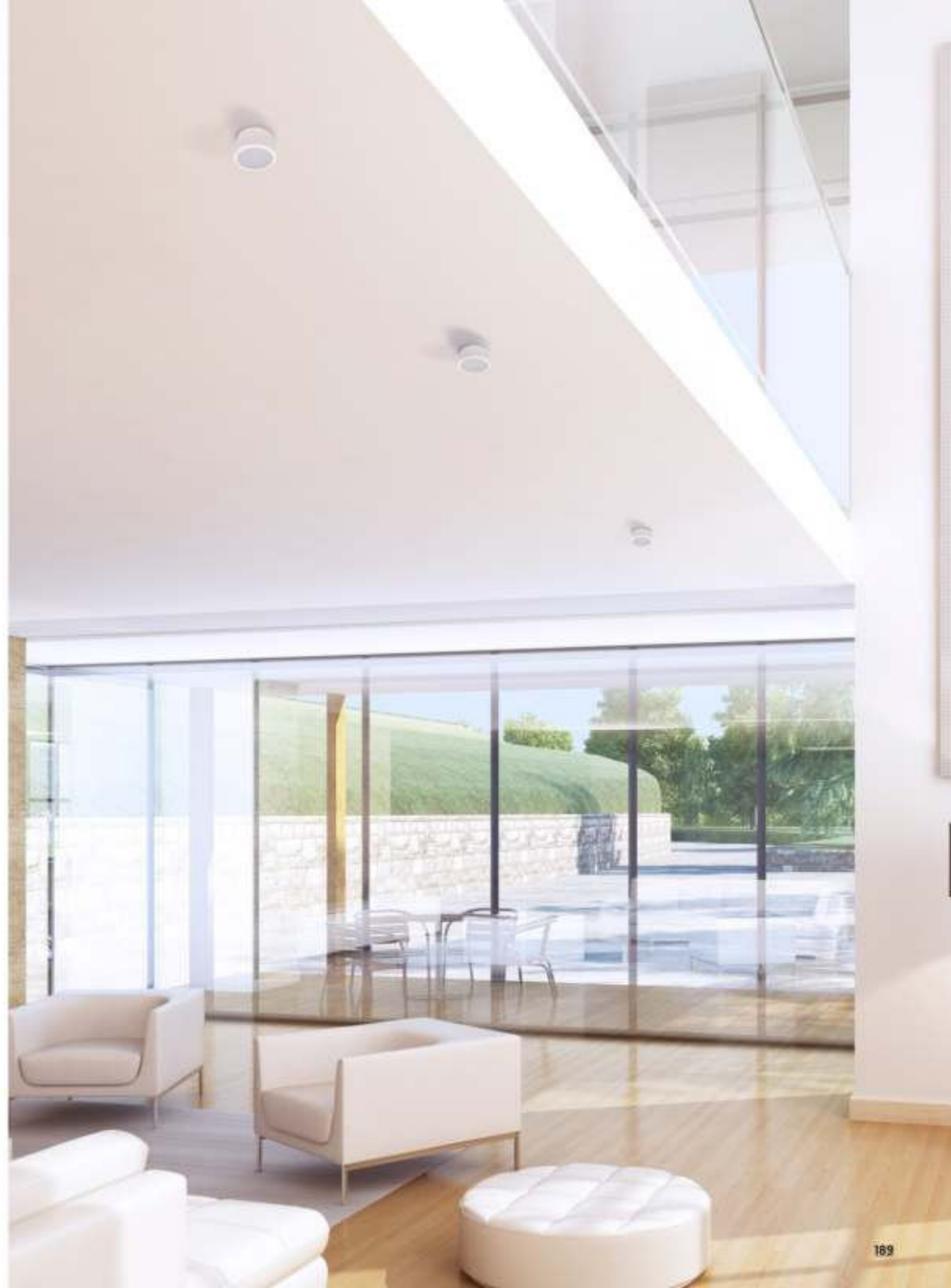
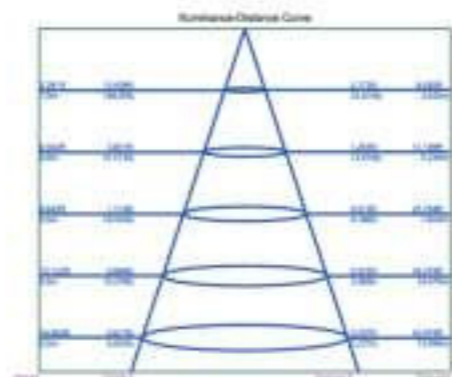
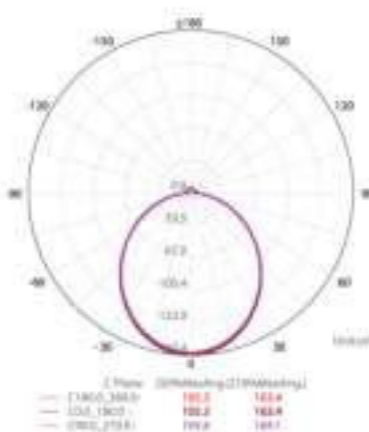

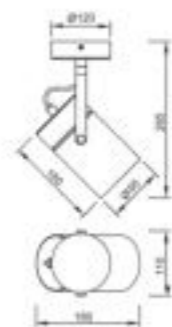

REFERENCE	BULB NO INCLUDED	FINISH
6015	1L • E27	Bianco-White
6016	1L • E27	Plata-Silver
máx. 20W LED (No incl)		100-240V-50/60Hz Metal-Metal



Mini Bulb E27



Multitask Bulb E27



Standard Bulb E27



R63 Bulb E27



R80 Bulb E27



6044  
pág 210

6022  
pág 160







REFERENCE	BULB NO INCLUDED	FINISH	DIAMETER (ø):
5626	1L • E27	Bianco-White	ø 120
5628	1L • E27	Plata-Silver	ø 120
5627	1L • E27	Bianco-White	ø 90
5629	1L • E27	Plata-Silver	ø 90
máx. 20W LED (No incl)		100-240V-50/60Hz Metal-Metal	

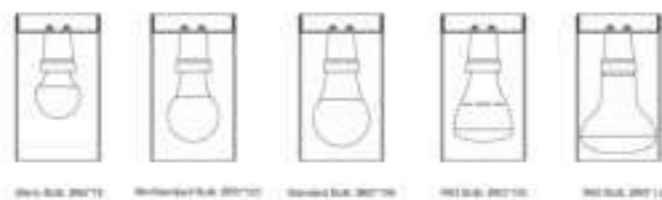
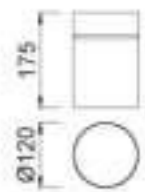

# COLUMBRETES

Indoor



ErP COMPLIANT DRIVER TUV RoHS COMPLIANT

REFERENCE	K	LED WATT	LUMENS	FINISH
C0087	3000K	12W	1040lm	Blanco mate-Matt white
		220-240V-50/60Hz CRI: ≥ 80		Aluminio-Aluminium

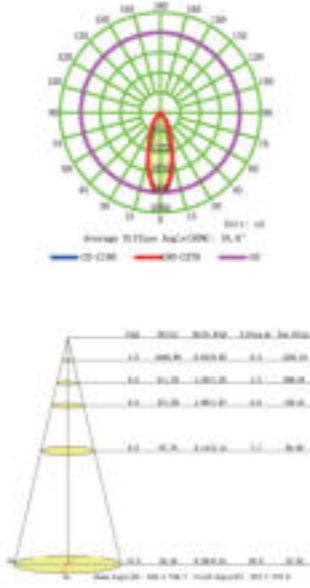
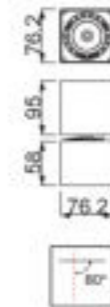
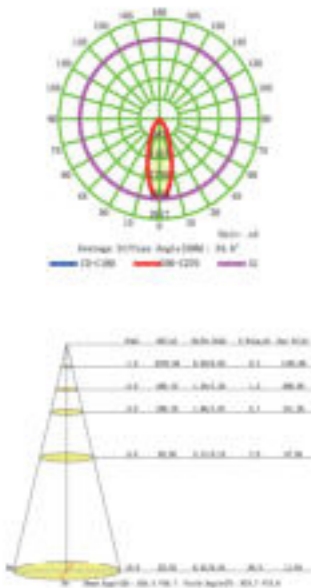

ErP COMPLIANT DRIVER TUV RoHS COMPLIANT

REFERENCE	K	LED WATT	LUMENS	FINISH
C0085	3000K	12W	1040lm	Blanco mate-Matt white
C0086	4000K	12W	1090lm	Blanco mate-Matt white
		220-240V-50/60Hz CRI: ≥ 80		Aluminio-Aluminium

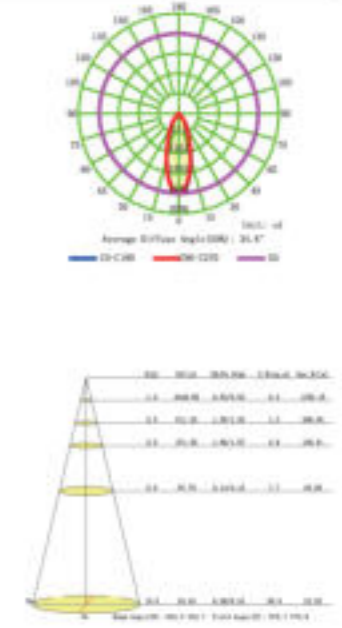
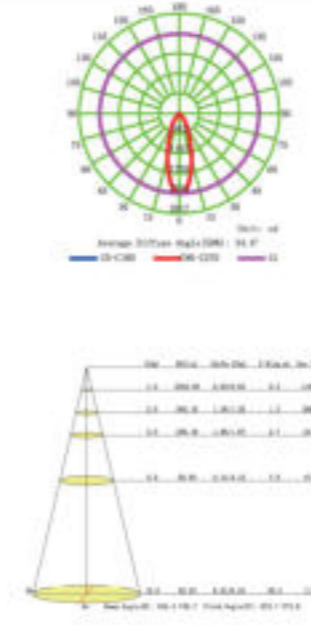

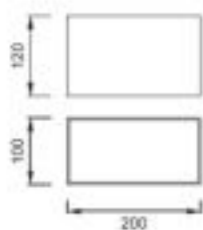

REFERENCE	BULB (No incl)	FINISH
5633	1L x GU10	Blanco mate-Matt white
5632	2L x GU10	Blanco mate-Matt white
máx. 12W LED (No incl)		100-240V-50/60Hz Aluminio-Aluminium



Bombillas recomendadas-Suggested bulbs

K	Wat LED	On/Off	Dimmable	Lumens
2700K	7W	R09254	R09257	510lm
3000K	7W	R09255	R09258	540lm
4000K	7W	R09256	R09259	570lm



# BORACAY

Aplicque/Foco superficie-Wall Lamp/Spotlight

Indoor

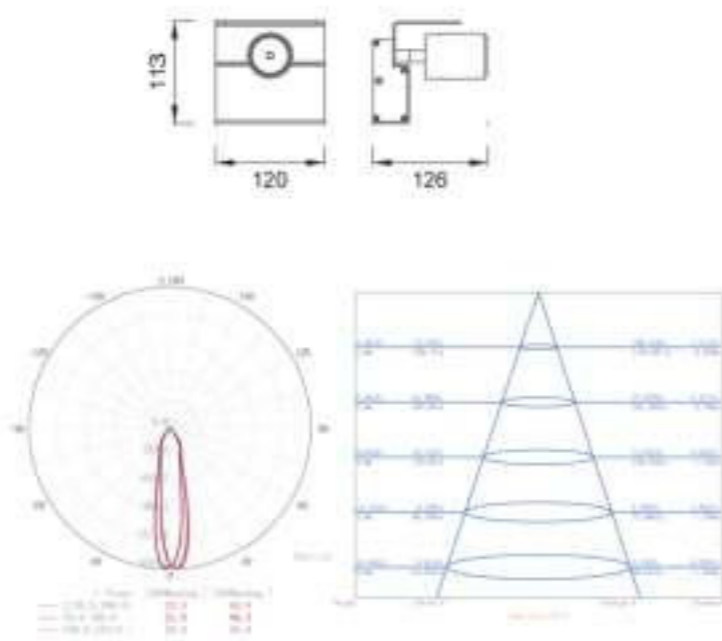

REFERENCE	K	LED WATT	LUMENS	FINISH
5717	3000K	7W	500lm	Bianco mate-Matt white
5718	4000K	7W	560lm	Bianco mate-Matt white
220-240V - 50/60Hz CRI > 80				Aluminio-Aluminium

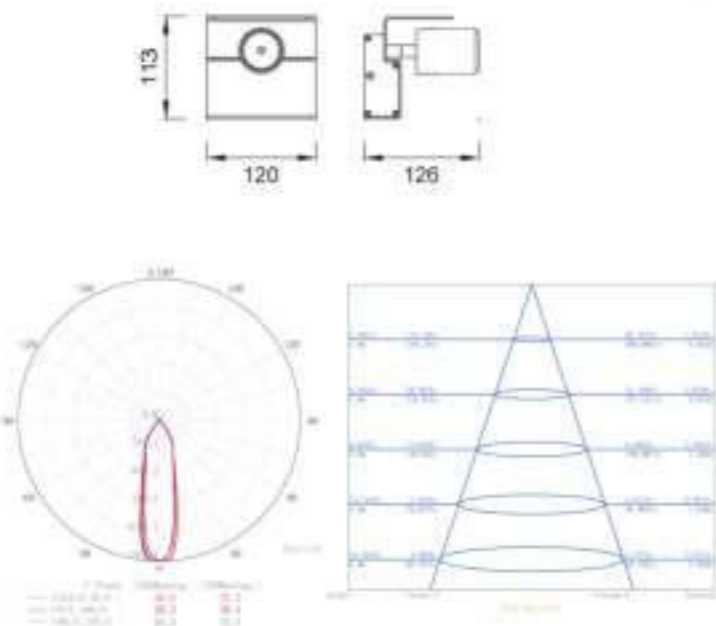



REFERENCE	K	LED WATT	LUMENS	FINISH
7315	3000K	35 W	3500lm	Bianco-White
7316	4000K	35 W	3850lm	Bianco-White
220-240V- 50/60Hz CRI≥90				Aluminio-Aluminium

LENTES-LENS

ref 7319 _13°	NOT INCLUDED
ref 7320 _24°	NOT INCLUDED
ref 7321 _38°	Included*

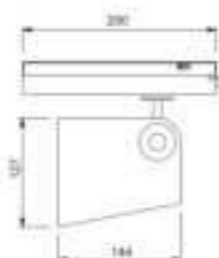

PANAL DE ABEJA-HONEYCOMB

ref 7322	NOT INCLUDED
----------	--------------

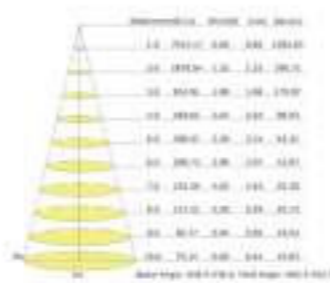

TIR LENS





REFERENCE	K	LED WATT	LUMENS	FINISH
7317	3000K	35 W	3500lm	Negro-Black
7318	4000K	35 W	3850lm	Negro-Black
220-240V- 50/60Hz CRI≥90				Aluminio-Aluminium

LENTES-LENS

ref 7319 _13°	NOT INCLUDED
ref 7320 _24°	NOT INCLUDED
ref 7321 _38°	included*

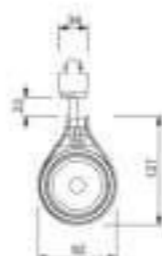
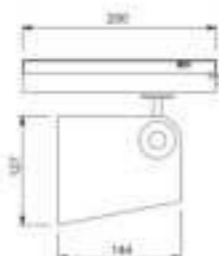

PANAL DE ABEJA-HONEYCOMB

ref 7322	NOT INCLUDED
----------	--------------

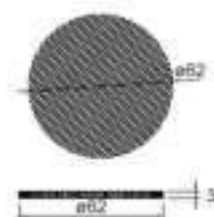

TIR LENS



**PAGODA**  
by David Villalba

Indoor



REFERENCE	BULB (No incl)	FINISH
7788	1L x GU10	Blanco mate-Matt white
7789	1L x GU10	Negro mate-Matt black
	máx. 12W LED (No incl)	100-240V ~ 50/60Hz Metal-Metal

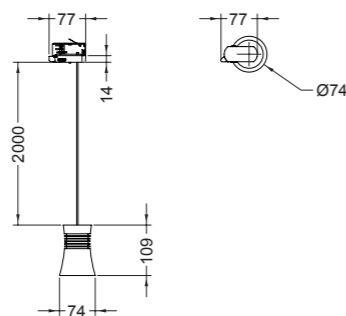

7787  
pág. 136



# PAGODA

by David Villalba

Indoor

UGR<16 CRi≥90



REFERENCE	K	LED WATT	LUMENS	FINISH
7780	3000K	12,5W	950lm	Blanco-White
7782	3000K	12,5W	950lm	Negro-Black
7781	4000K	12,5W	1050lm	Blanco-White
7783	4000K	12,5W	1050lm	Negro-Black
220-240V - 50/60Hz CRi≥90				Aluminio-Aluminium



TIR LENS

UGR<16





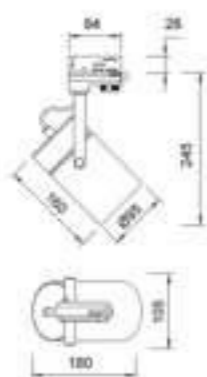

REFERENCE	BULB (No incl)	FINISH
6044	1L x E27	Blanco-White
6045	1L x E27	Negro-Black
máx. 20W LED (No incl)		100-240V-50/60Hz Metal-Metal



6015  
pág 190



5622  
pág 160



Classic Bulb: Ø40\*78

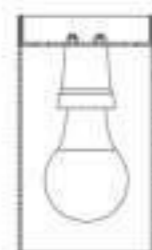

MiniStandard Bulb: Ø55\*103



Standard Bulb: Ø60\*108



R53 Bulb: Ø63\*108



R80 Bulb: Ø67\*114

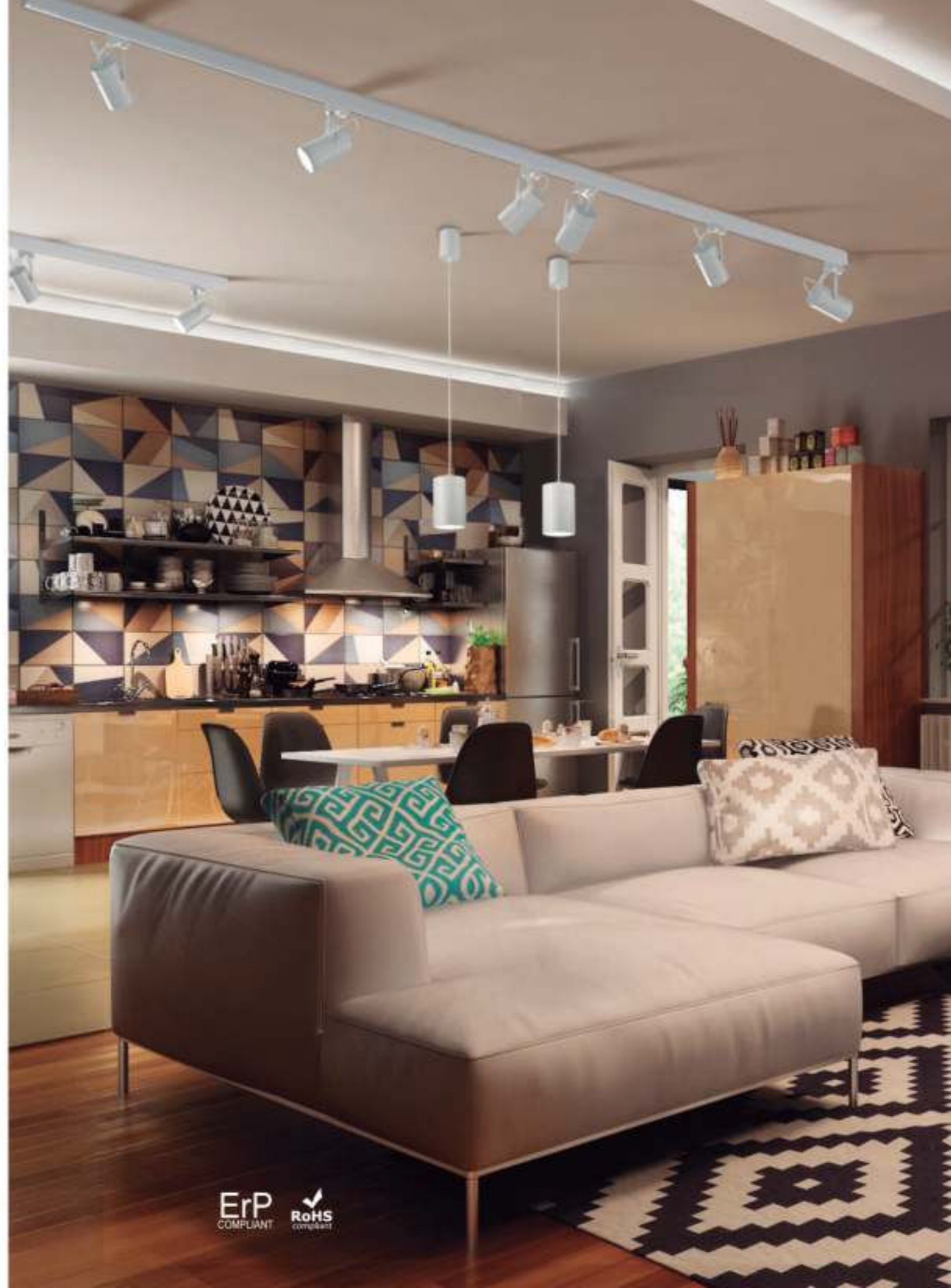

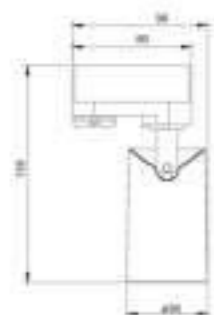

REFERENCE	BULB NOT INCLUDED	FINISH
6717	1L x GU10	Blanco-White
6718	1L x GU10	Negro-Black
máx. 10W LED (No incl) 100-240V - 50/60Hz Aluminio-Aluminium		



Bombillas recomendadas-Suggested bulbs

K	Wat LED	On/Off	Dimmable	Lumens
2700K	7W	R09254	R09257	510lm
3000K	7W	R09255	R09258	540lm
4000K	7W	R09256	R09259	570lm



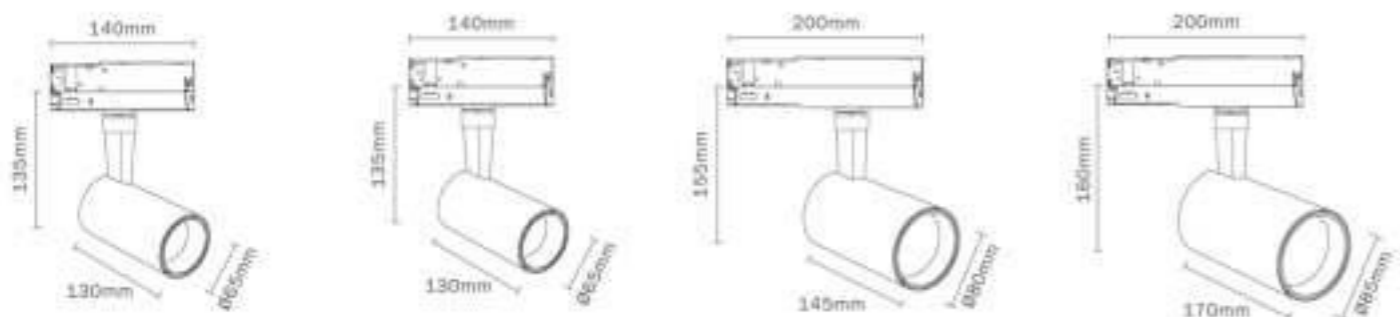

REFERENCE	K	LED WATT	LUMENS	FINISH	OPTICAL included*	ANGLE
7200	3000K	15W	1500lm	Blanca-White	7216	38°
7204	4000K	15W	1650lm	Blanca-White	7218	38°
7201	3000K	20W	2000lm	Blanca-White	7216	38°
7205	4000K	20W	2200lm	Blanca-White	7218	38°
7202	3000K	30W	3000lm	Blanca-White	7221	38°
7206	4000K	30W	3300lm	Blanca-White	7221	38°
7203	3000K	40W	4000lm	Blanca-White	7224	38°
7207	4000K	40W	4400lm	Blanca-White	7224	38°

220-240V - 50/60Hz CRI≥ 90    Aluminio-Aluminium

\* Reflector-Optic

REFERENCE 15/20W	REFERENCE 30W	REFERENCE 40W	BEAM ANGLE	INCLUDED
7216	7219	7222	15°	not included
7217	7220	7223	24°	not included
*7218	*7221	*7224	38°	Included*



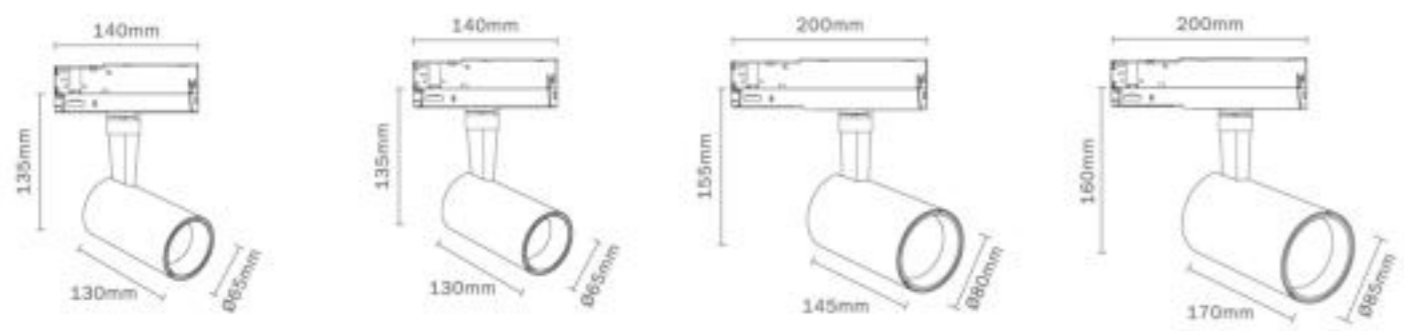

REFERENCE	K	LED WATT	LUMENS	FINISH	OPTICAL included*	ANGLE
7208	3000K	15W	1500lm	Negro-Black	7218	38°
7212	4000K	15W	1650lm	Negro-Black	7218	38°
7209	3000K	20W	2000lm	Negro-Black	7218	38°
7213	4000K	20W	2200lm	Negro-Black	7218	38°
7210	3000K	30W	3000lm	Negro-Black	7221	38°
7214	4000K	30W	3300lm	Negro-Black	7221	38°
7211	3000K	40W	4000lm	Negro-Black	7224	38°
7215	4000K	40W	4400lm	Negro-Black	7224	38°

220-240V- 50/60HzCRI≥ 90 Aluminio-Aluminium

\* Reflector-Optic

REFERENCE 15/20W	REFERENCE 30W	REFERENCE 40W	BEAM ANGLE	INCLUDED
7216	7219	7222	15°	not included
7217	7220	7223	24°	not included
*7218	*7221	*7224	38°	Included*



NEW COLLECTION

LED 15W 3000K 38°

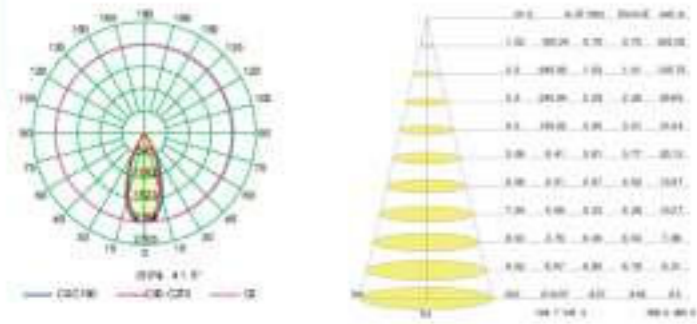

LED 15W 4000K 38°

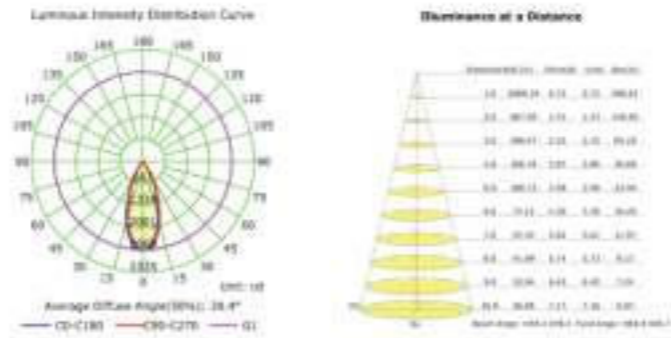

LED 20W 3000K 38°

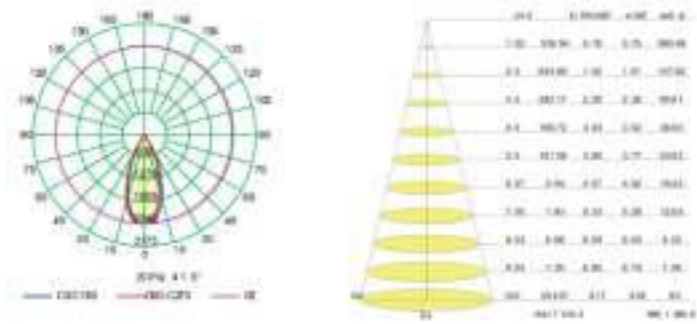

LED 20W 4000K 38°

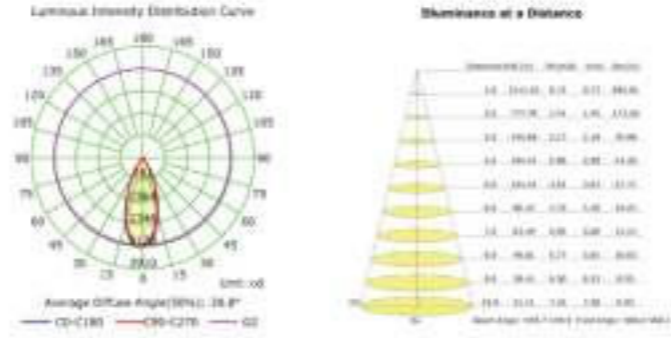

LED 30W 3000K 38°

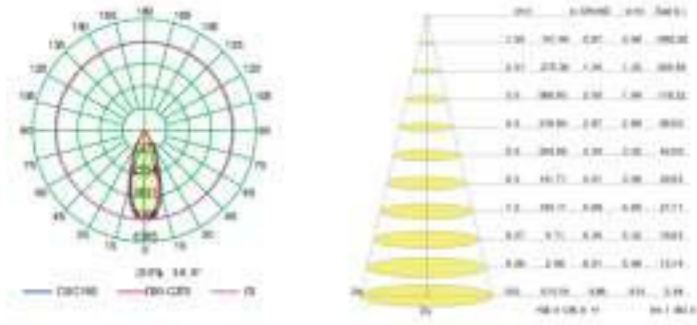

LED 30W 4000K 38°

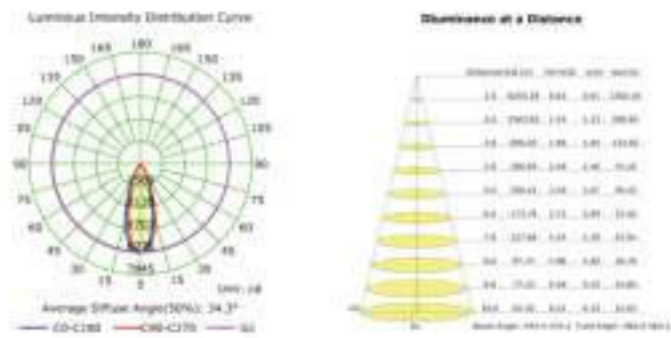

LED 40W 3000K 38°

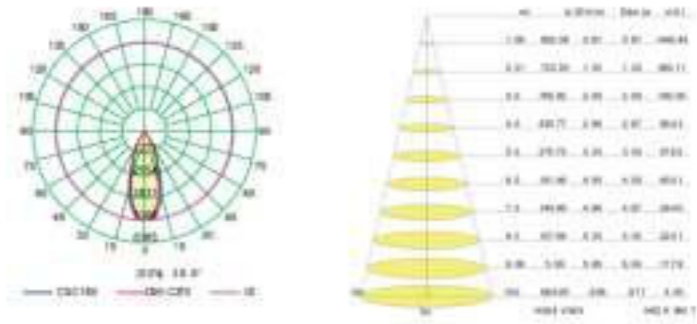

LED 40W 4000K 38°

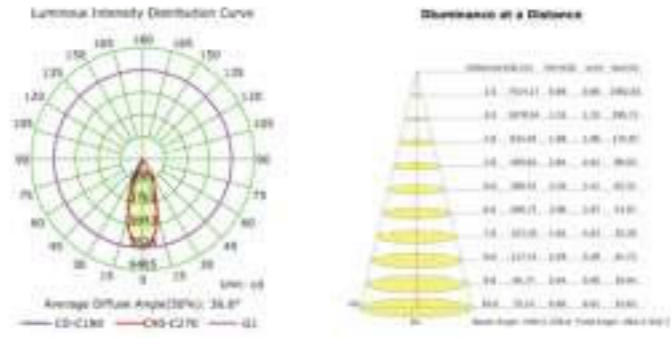

## CARRIL DE SUPERFICIE-SURFACE MOUNTED TRACK

XTS 41002 Negro-Black

XTS 41003 Blanco-White

Track length 1000 mm

XTS 42002 Negro-Black

XTS 42003 Blanco-White

Track length 2000 mm

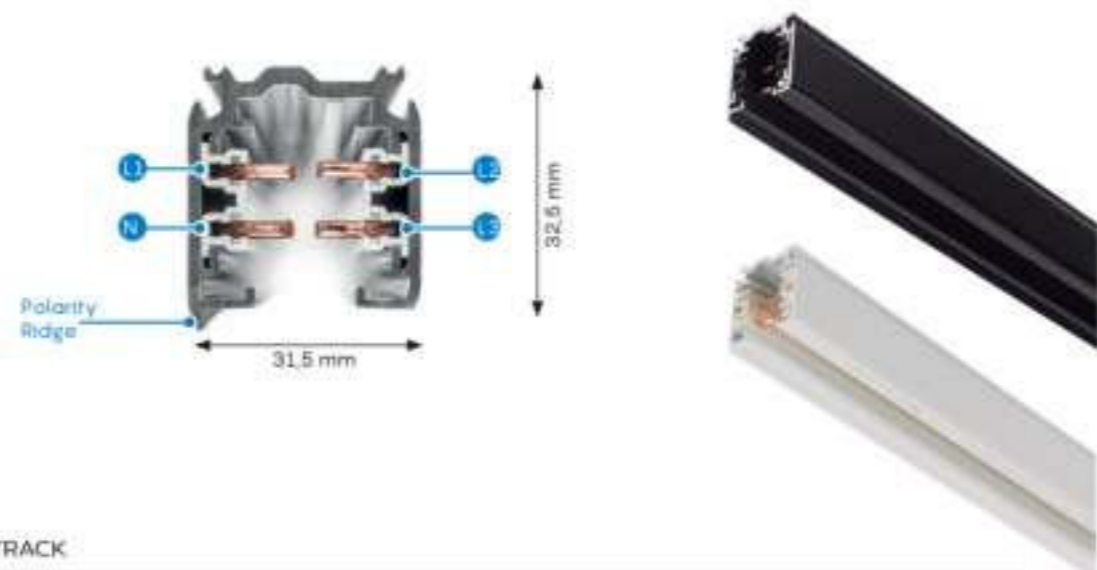

## CARRIL DE EMPOTRAR-RECESSED TRACK

XTSF41002 Negro-Black

XTSF41003 Blanco-White

Track length 1000 mm

XTSF42002 Negro-Black

XTSF 42003 Blanco-White

Track length 2000 mm

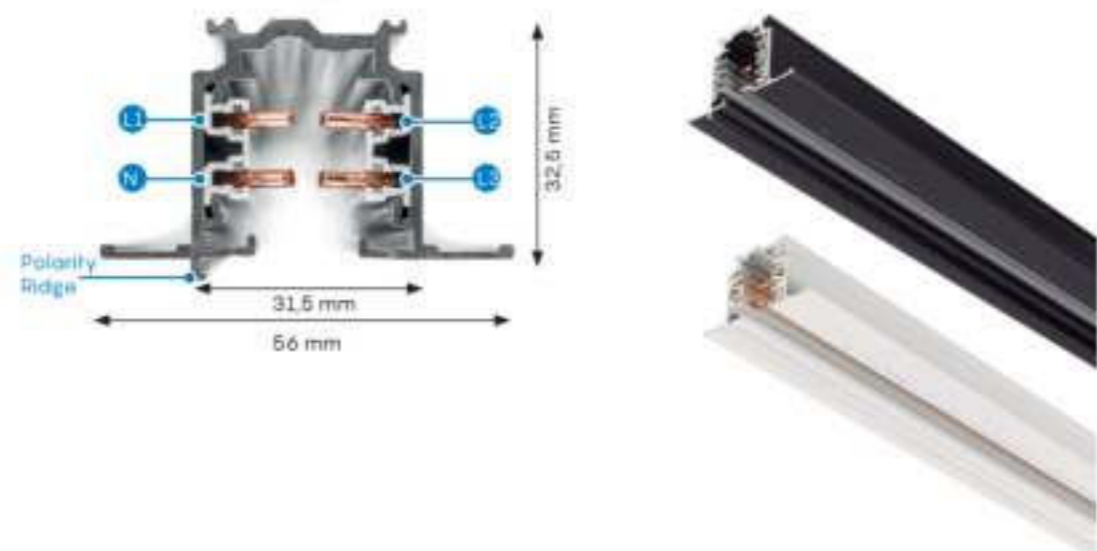

## FINAL ALIMENTADOR POLARIDAD DERECHA-END FEED POLARITY RIGHT

XTS 112 Negro-Black

XTS 113 Blanco-White



## FINAL ALIMENTADOR POLARIDAD IZQUIERDA-END FEED POLARITY LEFT

XTS 122 Negro-Black

XTS 123 Blanco-White



## TAPA FINAL-END CAP

XTS 412 Negro-Black

XTS 413 Blanco-White



## PLACA PARA CUBRIR EN CARRILES EMPOTRADOS -PLATE TO COVER IN RECESSED TRACKS

XTSF 102 Negro-Black XTS112/XTS122/XTS142

XTSF 103 Blanco-White XTS113/XTS123/XTS143



XTSF 302 Negro-Black XTS342/XTS352

XTSF 303 Blanco-White XTS343/XTS353



## LEVA FIJACIÓN TECHO FUNDICIÓN PARA CARRILES SUPERFICIE-STANDARD CLAMP DIE CAST FOR SURFACE TRACK

SKB 122 Negro-Black

SKB 123 Blanco-White



Power Conductor Cross-Section: 4,0mm<sup>2</sup>

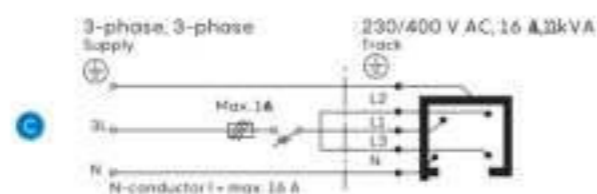
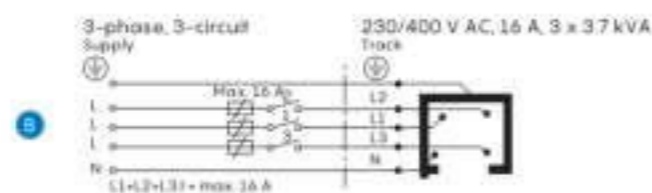
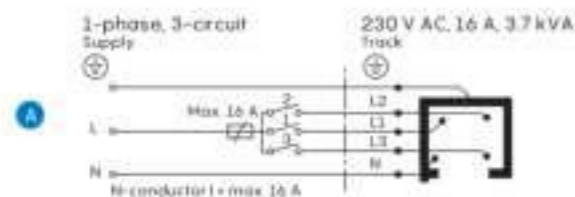

## ALIMENTADOR INTERMEDIO RECTO-MIDDLE FEED STRAIGHT

XTS 142 Negro-Black

XTS 143 Blanco-White



## CONECTOR INTERMEDIO RECTO-MIDDLE STRAIGHT CONNECTOR

XTS 212 Negro-Black

XTS 213 Blanco-White



## CONECTOR ESQUINA AJUSTABLE-ADJUSTABLE CORNER CONNECTOR

XTS 242 Negro-Black

XTS 243 Blanco-White



## CONEXIÓN ALIMENTADOR EN L POLARIDAD INTERNA - L FEED POLARITY INTERNAL

XTS 342 Negro-Black

XTS 343 Blanco-White



## CONEXIÓN ALIMENTADOR EN L POLARIDAD EXTERNA - L FEED POLARITY EXTERNAL

XTS 352 Negro-Black

XTS 353 Blanco-White



## CONEXIÓN ALIMENTADOR EN X - X FEED

XTS 382 Negro-Black

XTS 383 Blanco-White

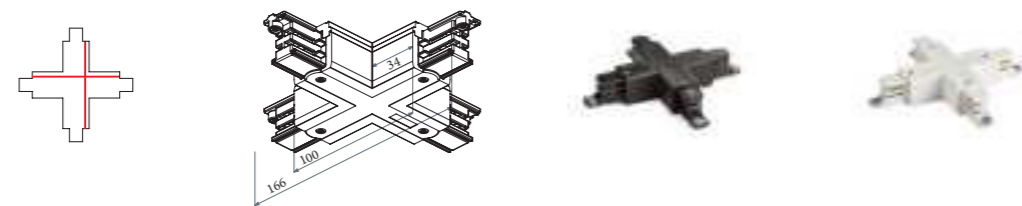

## CONEXIÓN ALIMENTADOR EN T- T FEED

XTS 362 Negro-Black

XTS 363 Blanco-White



XTS 372 Negro-Black

XTS 373 Blanco-White

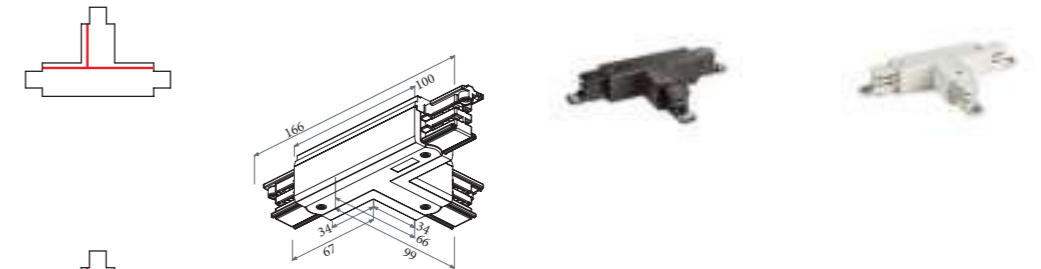

XTS 392 Negro-Black

XTS 393 Blanco-White



XTS 402 Negro-Black

XTS 403 Blanco-White

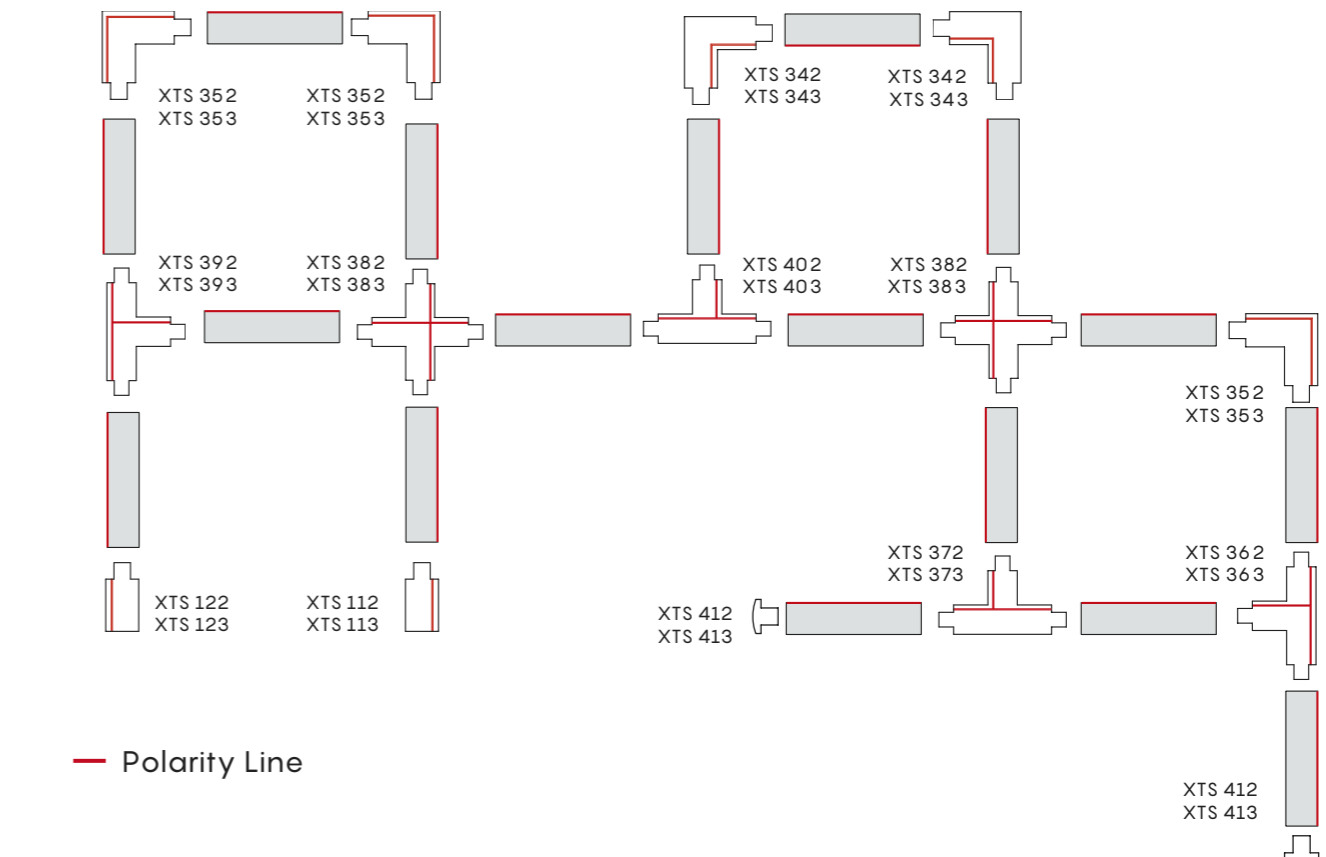

— Polarity Line

# GUINCHO

Empotrable-Recessed

Indoor  
IP54

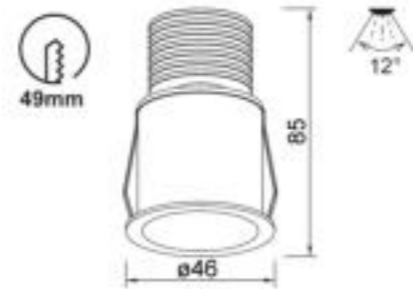
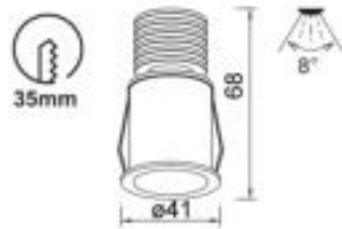

REFERENCE	K	LED WATT	LUMENS	FINISH
7080	2700K	3W	210lm	Bianco arena-Sand white
7081	2700K	3W	210lm	Negro arena-Sans black
6855	3000K	3W	210lm	Bianco arena-Sand white
6856	3000K	3W	210lm	Negro arena-Sans black
6859	4000k	3W	210lm	Bianco arena-Sand white
6860	4000k	3W	210lm	Negro arena-Sans black
7082	2700K	5W	410lm	Bianco arena-Sand white
7083	2700K	5W	410lm	Negro arena-Sans black
6857	3000K	5W	410lm	Bianco arena-Sand white
6858	3000K	5W	410lm	Negro arena-Sans black
6861	4000k	5W	410lm	Bianco arena-Sand white
6862	4000k	5W	410lm	Negro arena-Sans black
200-240V- 50/60Hz CRI:≥ 80				Aluminio-Aluminium

6855-6856

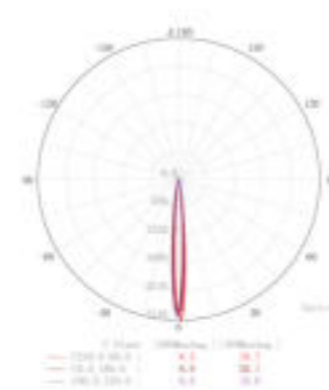

6857-6858

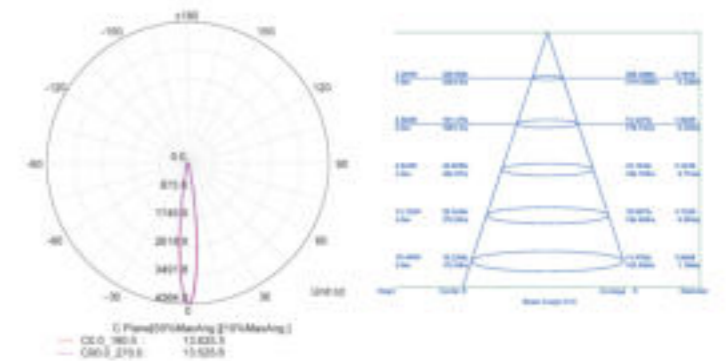

7080-7081

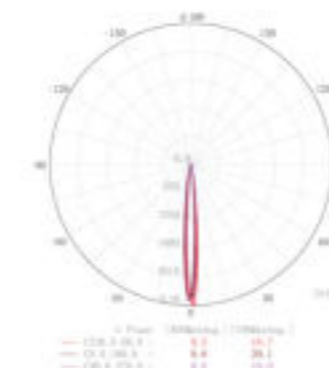

7082-7083

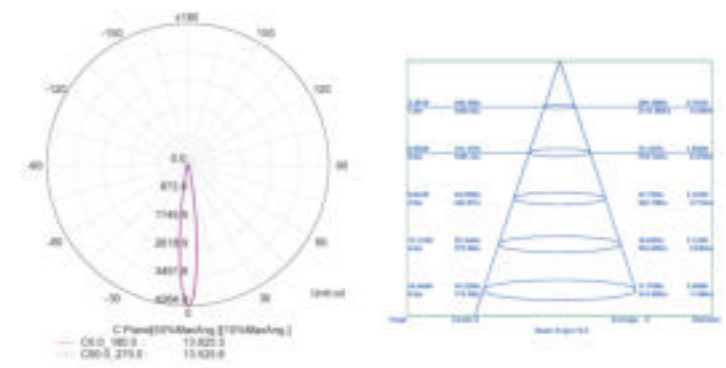



# GUINCHO GU10

Empotrable - Recessed

Indoor

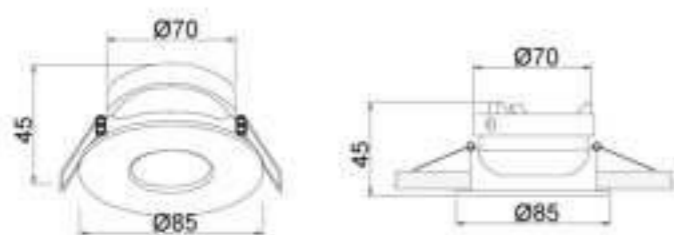

REFERENCE	BULB NO INCLUDED	FINISH
7535	1 x GU10	Blanco arena - Sand white
7536	1 x GU10	Negro arena - Sand black
GU10 max 10W Led		100-240V - 50/60Hz Aluminio - Aluminium



K	Wat LED	On/Off	Dimmable	Lumens
2700K	7W	R09254	R09257	510lm
3000K	7W	R09255	R09258	540lm
4000K	7W	R09256	R09259	570lm



# GARDA

Empotrabile - Recessed

Indoor



	REFERENCE	K	LED WATT	LUMENS	FINISH
New	7829	2700K	7W	610lm	Bianco-White
New	7831	2700K	7W	610lm	Negro-Black
	6400	3000K	7W	610lm	Bianco-White
New	7833	3000K	7W	610lm	Negro-Black
	6401	4000K	7W	630lm	Bianco-White
New	7830	2700K	12W	1020lm	Bianco-White
New	7832	2700K	12W	1020lm	Negro-Black
	6402	3000K	12W	1020lm	Bianco-White
New	7834	3000K	12W	1020lm	Negro-Black
	6403	4000K	12W	1080lm	Bianco-White

220-240V - 50/60Hz CRi ≥ 80

Aluminio ABS - Aluminium

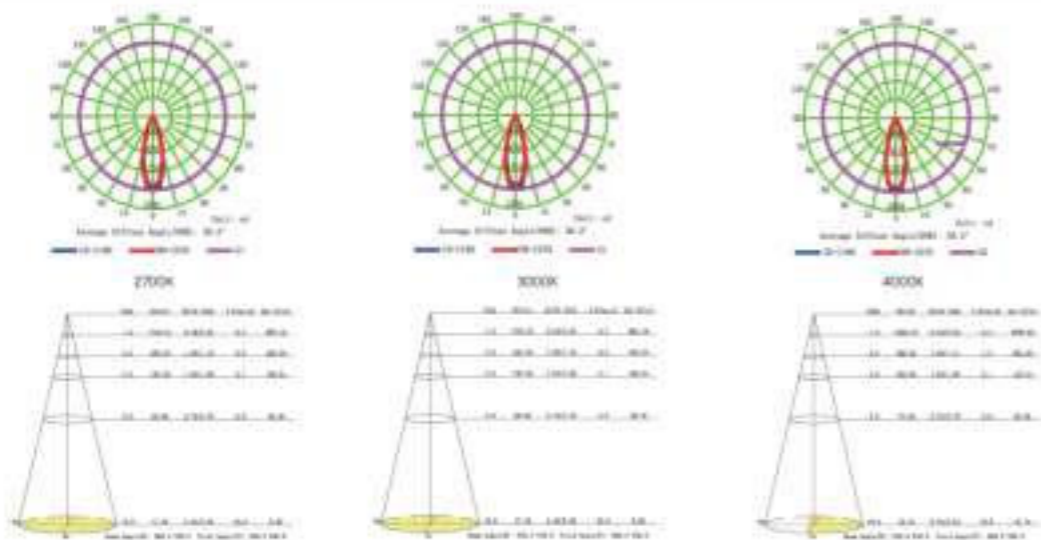

# NEPTUNO

Empotrable - Recessed

Indoor

CRi>90

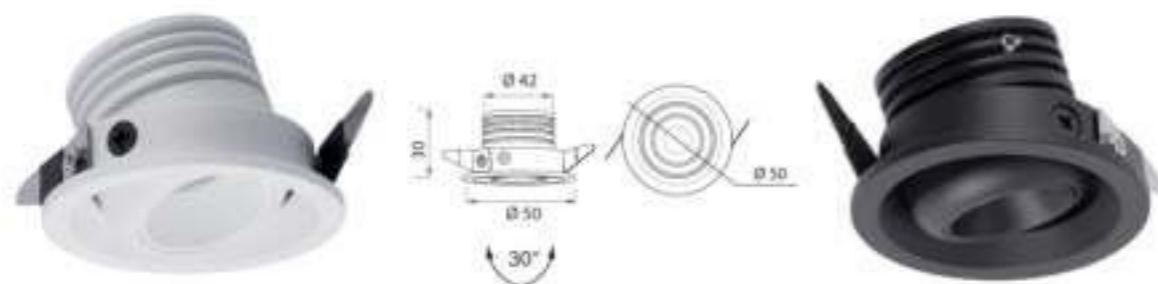

REFERENCE	K	LED WATT	LUMENS	FINISH
New 7827	2700K	3W	210lm	Blanco-White
New 7828	2700K	3W	210lm	Negro-Black
7451	3000K	3W	210lm	Blanco-White
7453	3000K	3W	210lm	Negro-Black
7452	4000K	3W	220lm	Blanco-White
7454	4000K	3W	220lm	Negro-Black

100-240V - 50/60Hz CRi > 90      Aluminio - Aluminium

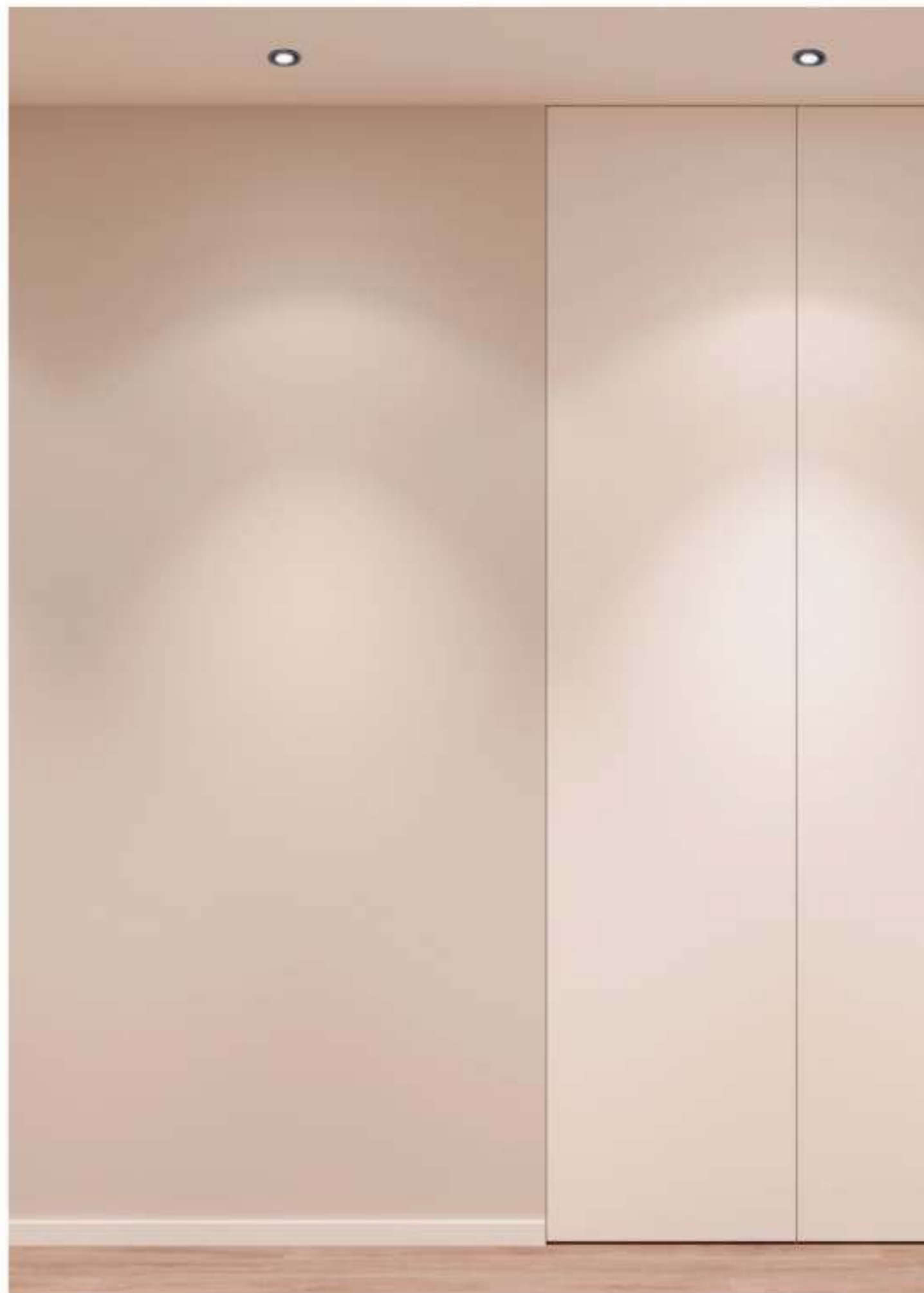
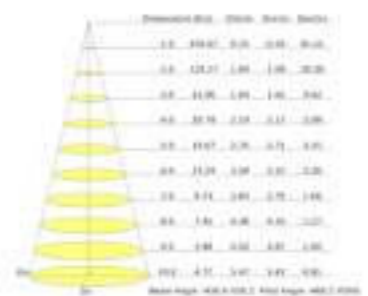
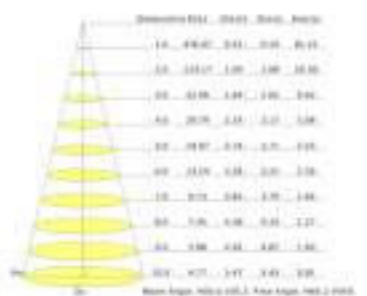
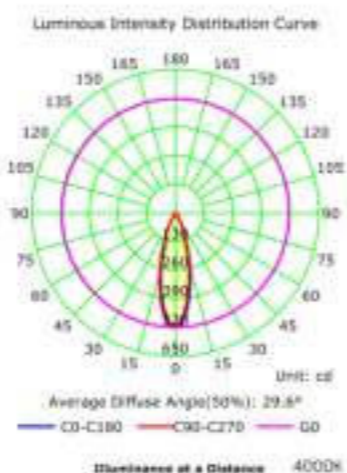
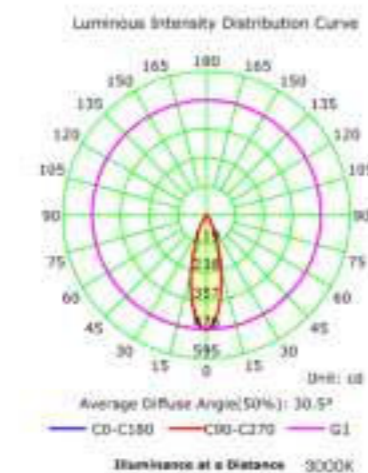
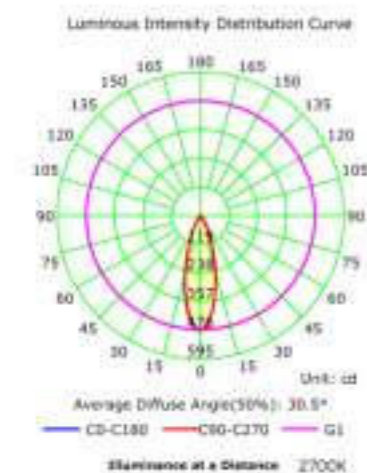



C0073-C0074



C0071-C0072



C0077-C0078



C0079-C0080



C0075-C0076

REFERENCE	K	LED WATT	LUMENS	FINISH
C0071	3000K	7W	610lm	Bianco mate-Matt white
C0072	4000K	7W	650lm	Bianco mate-Matt white
C0073	3000K	12W	1040lm	Bianco mate-Matt white
C0074	4000K	12W	1080lm	Bianco mate-Matt white
				Aluminio-Aluminium
220-240V - 50/60Hz CRI: 80				

REFERENCE	K	LED WATT	LUMENS	FINISH
C0075	3000K	7W	610lm	Bianco mate-Matt white
C0076	4000K	7W	650lm	Bianco mate-Matt white
C0079	3000K	7W	610lm	Bianco mate-Matt white
C0080	4000K	7W	650lm	Bianco mate-Matt white
C0077	3000K	12W	1040lm	Bianco mate-Matt white
C0078	4000K	12W	1080lm	Bianco mate-Matt white
				Aluminio-Aluminium
220-240V - 50/60Hz CRI: 80				

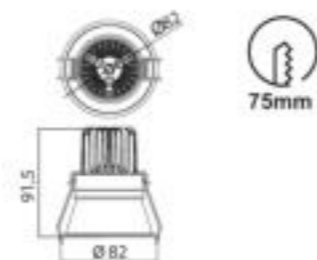
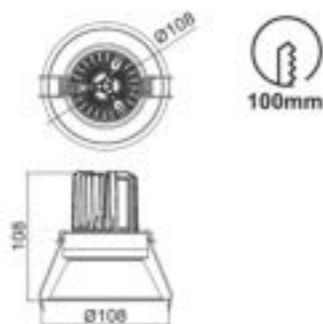

C0077-C0078

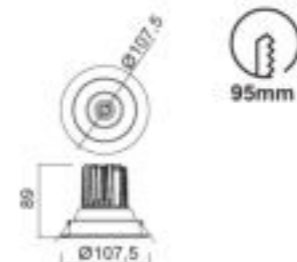

C0079

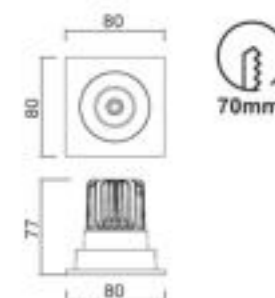

C0075-C0076

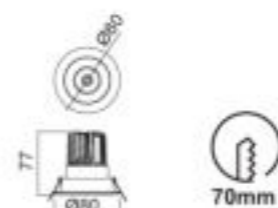

C0080



# FORMENTERA

# Indoor

C0073

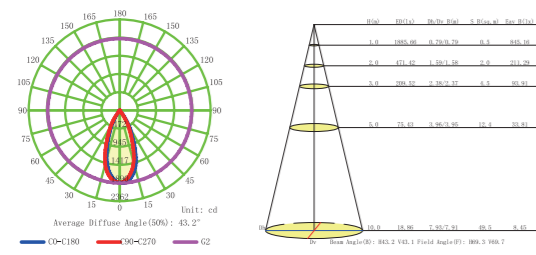

C0077

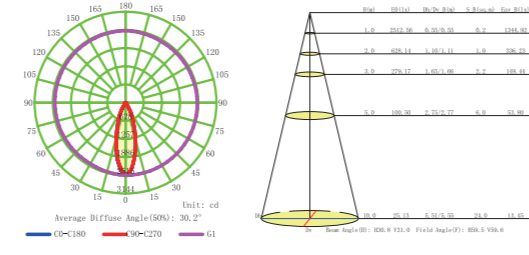

C0074

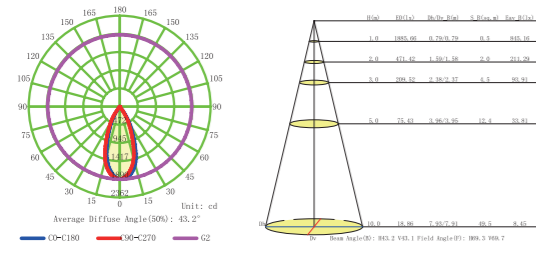

C0078

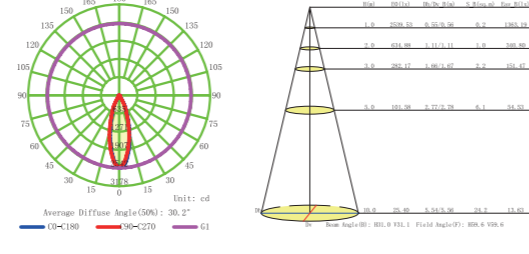

C0071

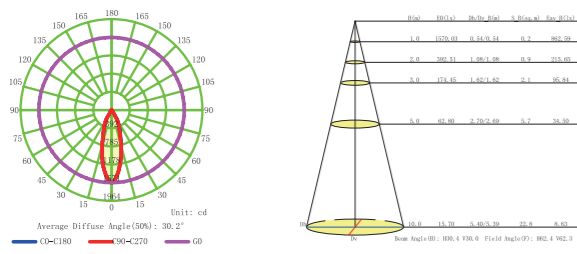

C0075

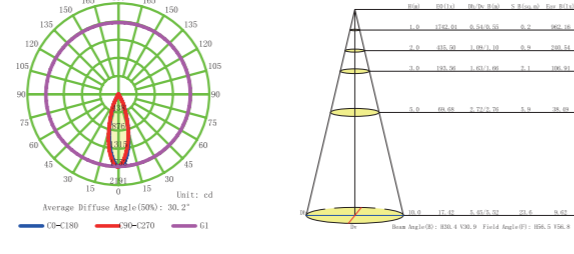

C0072

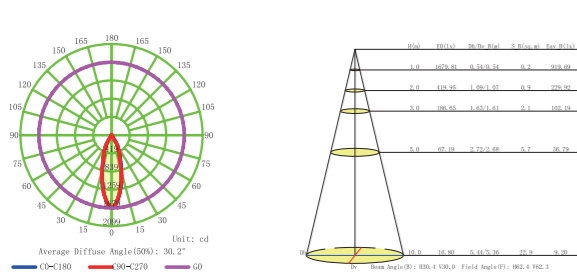

C0076

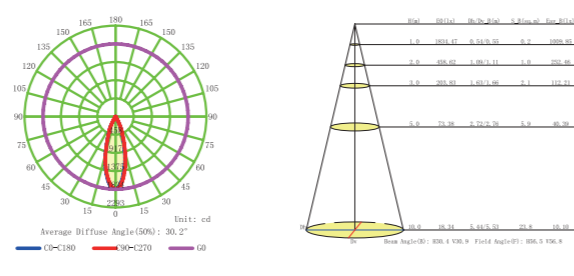

C0079

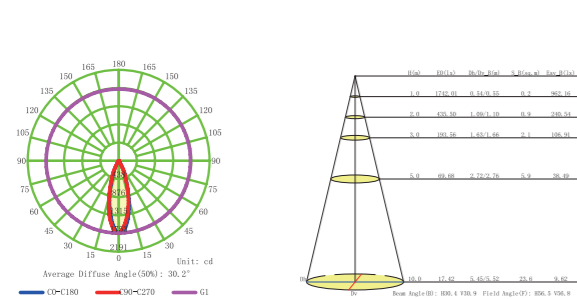

C0080

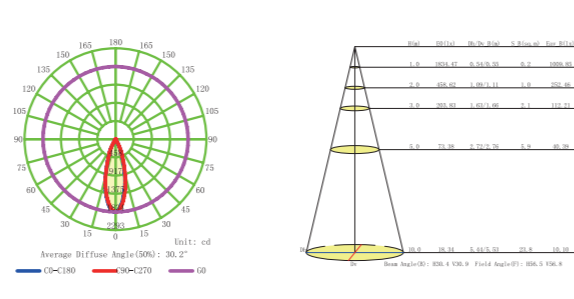

# CABRERA

Empotrable - Recessed

Indoor

C0044

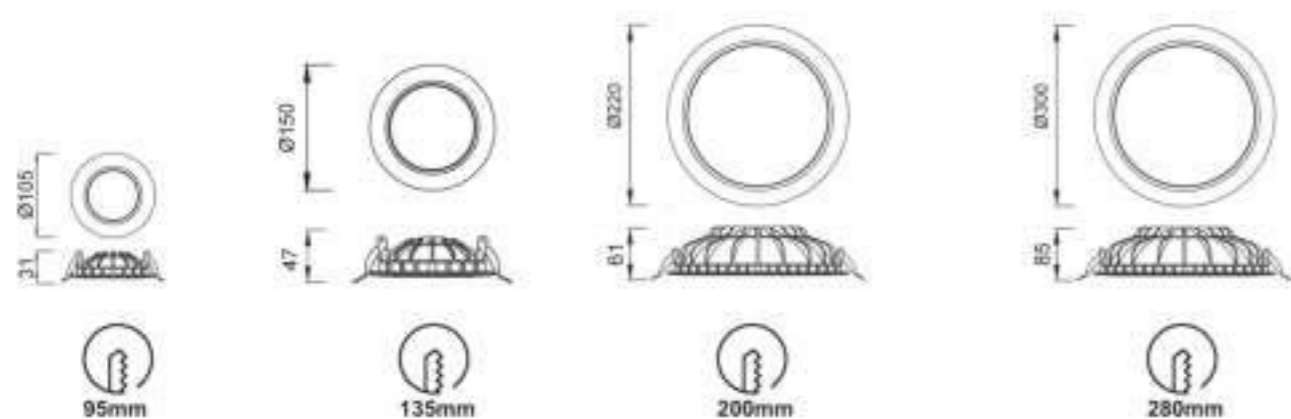

REFERENCE	K	LED WATT	LUMENS	FINISH
C0041	3000K	7W	540lm	Bianco mate-Matt white
C0042	4000K	7W	540lm	Bianco mate-Matt white
C0047	3000K	12W	1080lm	Bianco mate-Matt white
C0048	4000K	12W	1080lm	Bianco mate-Matt white
C0043	3000K	24W	2160lm	Bianco mate-Matt white
C0044	4000K	24W	2160lm	Bianco mate-Matt white
C0049	3000K	30W	2550lm	Bianco mate-Matt white
C0050	4000K	30W	2600lm	Bianco mate-Matt white
220-240V - 50/60Hz CRI > 80				Aluminio-Aluminium

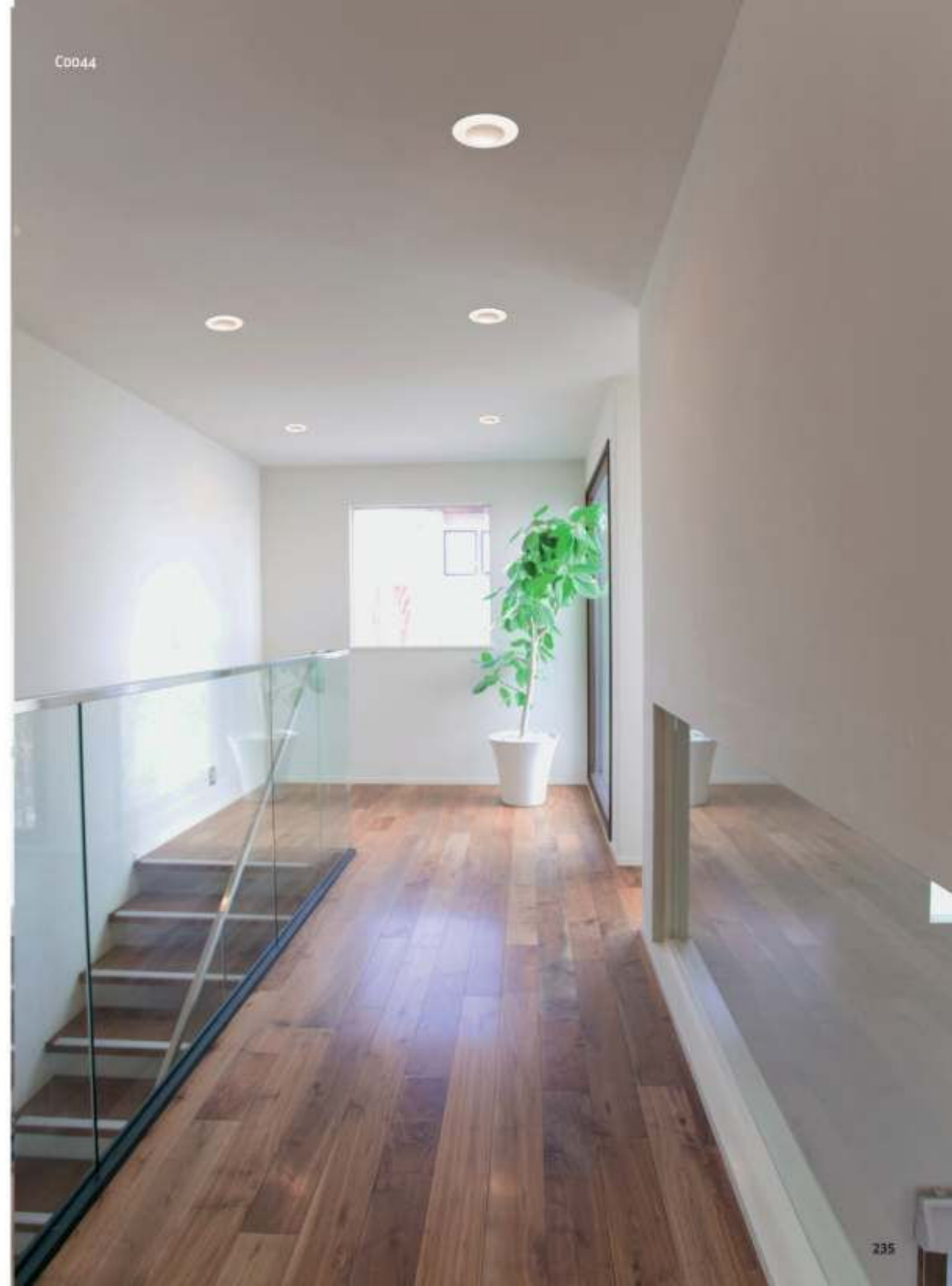

# MEDANO

Empotrabile - Recessed

Indoor

UGR<19

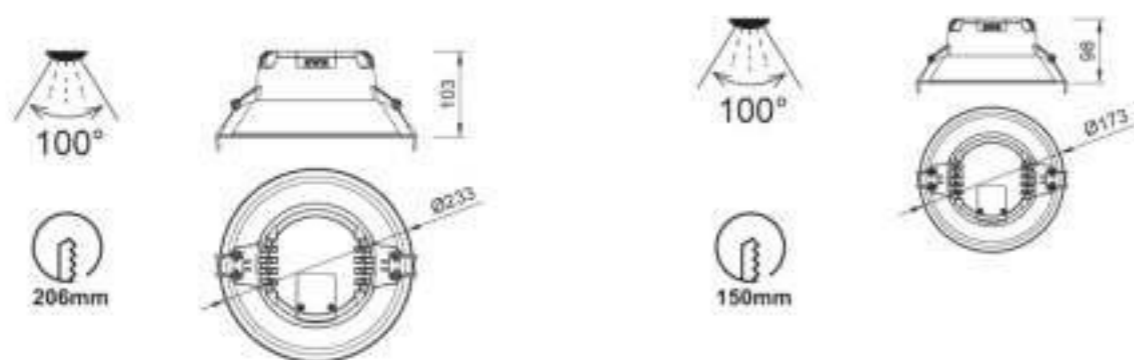

REFERENCE	K	LED WATT	LUMENS	FINISH
6398	3000K	12W	1100lm	Bianco mate-Matt white
6399	4000K	12W	1200lm	Bianco mate-Matt white
6395	3000K	21W	1900lm	Bianco mate-Matt white
6396	4000K	21W	2100lm	Bianco mate-Matt white
SPCC-PBT/PC		220-240V- 50/60Hz CRI ≥ 80		Aluminio-Aluminium

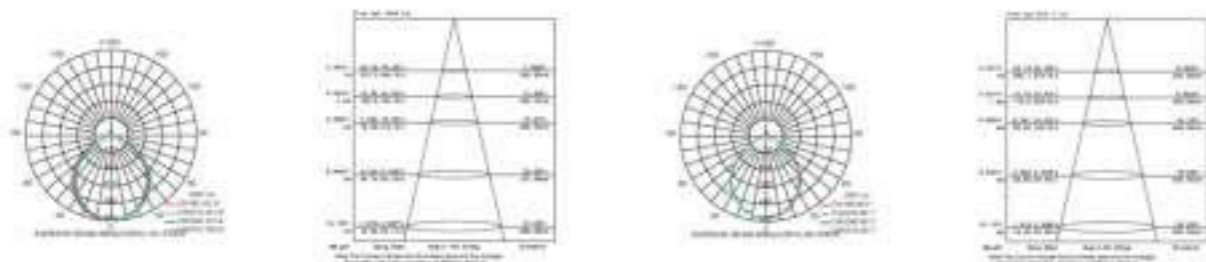

Empotrable-Recessed

Indoor



REFERENCE	K	LED WATT	LUMENS	FINISH
C0184	3000K	6W	520lm	Blanco mate-Matt white
C0180	4000K	6W	540lm	Blanco mate-Matt white
C0185	3000K	12W	990lm	Blanco mate-Matt white
C0181	4000K	12W	1080lm	Blanco mate-Matt white
SPCC-PBT/PC		220-240V - 50/60Hz CRI: ≥ 80		Aluminio-Aluminium

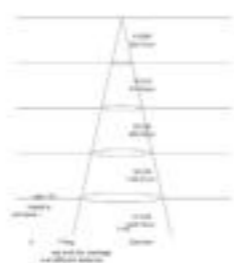
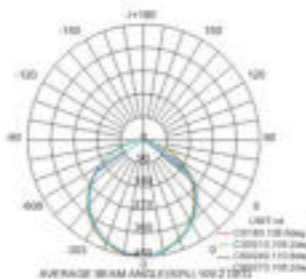
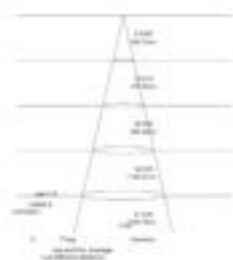
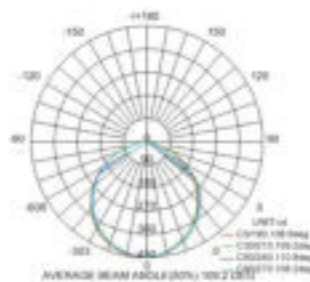

REFERENCE	K	LED WATT	LUMENS	FINISH
C0186	3000K	18W	1580lm	Blanco mate-Matt white
C0182	4000K	18W	1620lm	Blanco mate-Matt white
C0187	3000K	24W	2090lm	Blanco mate-Matt white
C0183	4000K	24W	2200lm	Blanco mate-Matt white
SPCC-PBT/PC		220-240V - 50/60Hz CRI: ≥ 80		Aluminio-Aluminium

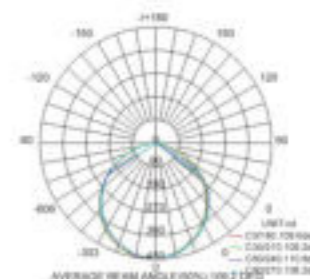
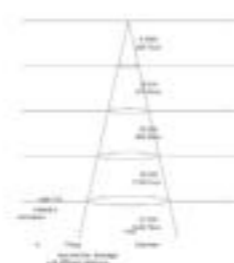
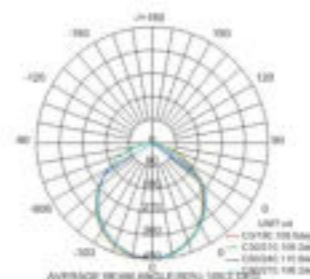





REFERENCE	K	LED WATT	LUMENS	FINISH
C0194	3000K	6W	520lm	Blanco mate - Matt white
C0190	4000K	6W	540lm	Blanco mate - Matt white
C0195	3000K	12W	990lm	Blanco mate - Matt white
C0191	4000K	12W	1080lm	Blanco mate - Matt white
SPCC - PBT/PC 220-240V - 50/60Hz CRI: 80				Aluminio - Aluminium

REFERENCE	K	LED WATT	LUMENS	FINISH
C0196	3000K	18W	1580lm	Blanco mate - Matt white
C0192	4000K	18W	1620lm	Blanco mate - Matt white
C0197	3000K	24W	2090lm	Blanco mate - Matt white
C0193	4000K	24W	2200lm	Blanco mate - Matt white
SPCC - PBT/PC 220-240V - 50/60Hz CRI: 80				Aluminio - Aluminium

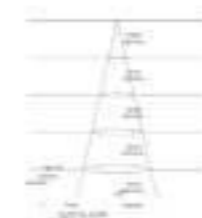
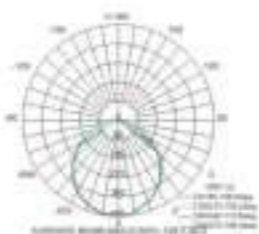
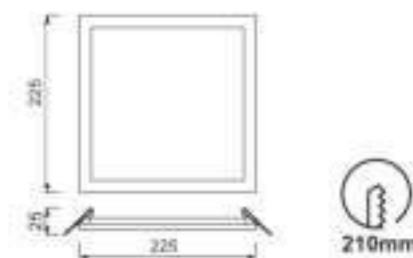
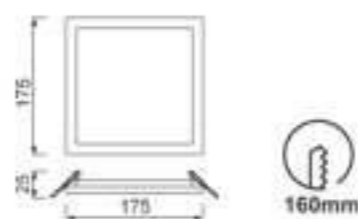
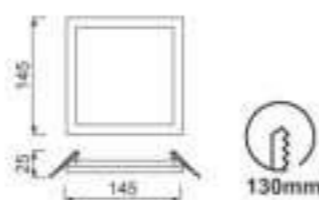
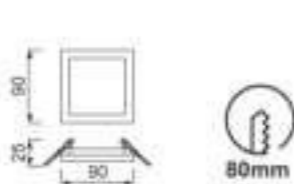

# GRACIOSA

Empotrable-Recessed

Indoor



REFERENCE	K	LED WATT	LUMENS	FINISH	SIZES
6392	3000K	15,3W	1100lm	Blanco mate-Matt white	Ø180
6397	4000K	10,8W	850lm	Blanco mate-Matt white	Ø146
				220-240V - 50/60Hz CRi: ≥ 80	Aluminio-Aluminium

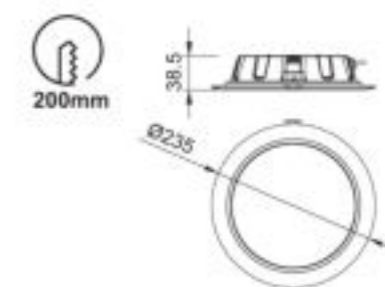
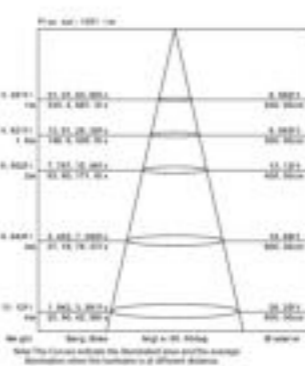
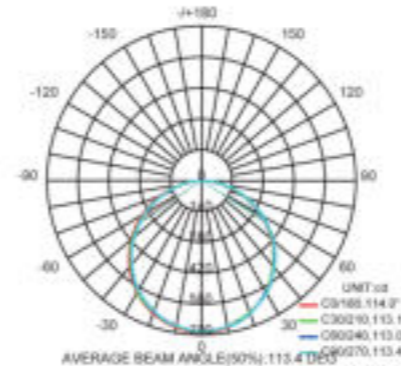
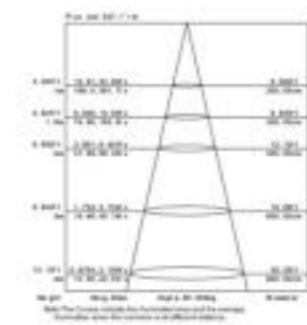
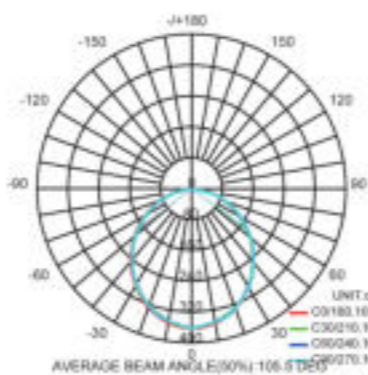
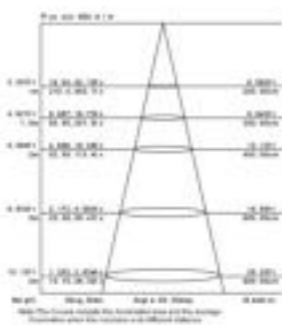
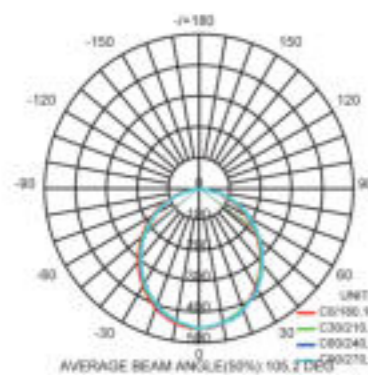
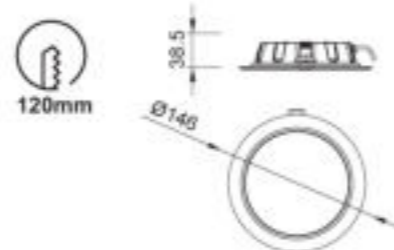
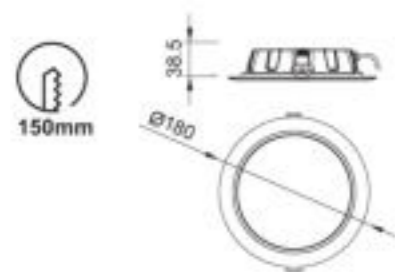

REFERENCE	K	LED WATT	LUMENS	FINISH	SIZES
6390	3000K	24,5W	1900lm	Blanco mate-Matt white	Ø235
				220-240V - 50/60Hz CRi: ≥ 80	Aluminio-Aluminium

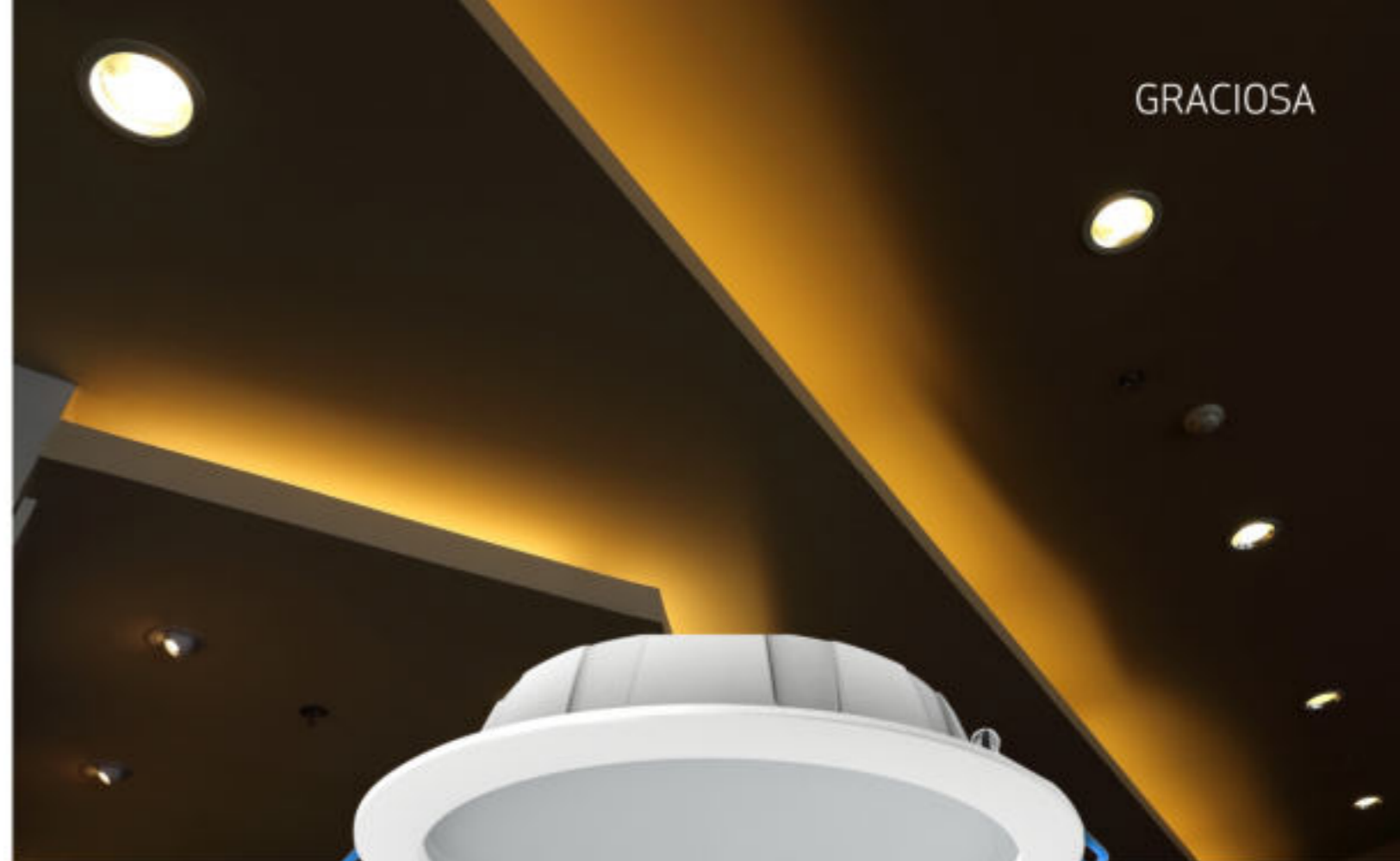

# GRACIOSA



# BÁSICO GU10

Empotrable-Recessed

Indoor

C0002

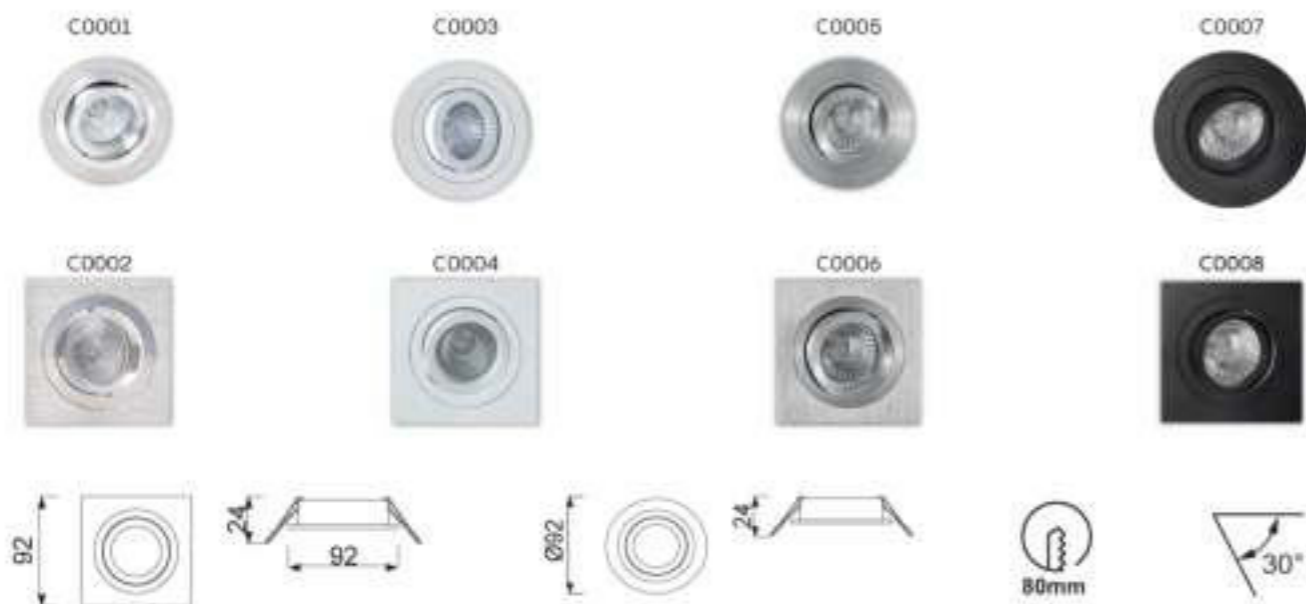

REFERENCE	BULB NO INCLUDED	FINISH
C0001	1 x GU10	Nickel Satinado/Cromo-Satin Nickel/Chrome
C0002	1 x GU10	Nickel Satinado/Cromo-Satin Nickel/Chrome
C0003	1 x GU10	Blanco mate-Matt white
C0004	1 x GU10	Blanco mate-Matt white
C0005	1 x GU10	Aluminio Pulido-Polished Aluminium
C0006	1 x GU10	Aluminio Pulido-Polished Aluminium
C0007	1 x GU10	Negro mate-Matt black
C0008	1 x GU10	Negro mate-Matt black
GU10 máx 12W Led		100-240V- 50/60Hz Aluminio-Aluminium



Bombillas recomendadas-Suggested bulbs

K	Wat LED	On/Off	Dimmable	Lumens
2700K	7W	R09254	R09257	510lm
3000K	7W	R09255	R09258	540lm
4000K	7W	R09256	R09259	570lm



# BÁSICO GU10

Empotrable-Recessed

Indoor



REFERENCE	BULB NO INCLUDED	FINISH
7740	1 x GU10	Nickel Satinado/Cromo-Satin Nickel/Chrome
7741	1 x GU10	Blanco mate-Matt white
7742	1 x GU10	Aluminio Pulido-Polished Aluminium
7743	1 x GU10	Negro mate-Matt black
GU10 máx 12W Led		100-240V - 50/60Hz Aluminio-Aluminium



Bombillas recomendadas-Suggested bulbs

K	Wat LED	On/Off	Dimmable	Lumens
2700K	7W	R09254	R09257	510lm
3000K	7W	R09255	R09258	540lm
4000K	7W	R09256	R09259	570lm



# COMFORT GU10

Empotrable-Recessed

Indoor

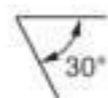

REFERENCE	BULB NO INCLUDED	FINISH
C0160	1 x GU10	Bianco mate-Matt white
C0161	1 x GU10	Plata mate-Matt silver
C0164	1 x GU10	Negro mate-Matt black
GU10 máx 12W Led		100-240V- 50/60Hz Aluminio-Aluminium

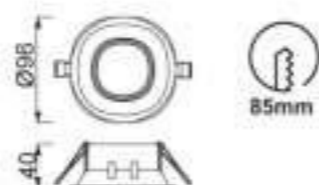

REFERENCE	BULB NO INCLUDED	FINISH
C0162	1 x GU10	Bianco mate-Matt white
C0163	1 x GU10	Plata mate-Matt silver
C0166	1 x GU10	Negro mate-Matt black
GU10 máx 12W Led		100-240V- 50/60Hz Aluminio-Aluminium

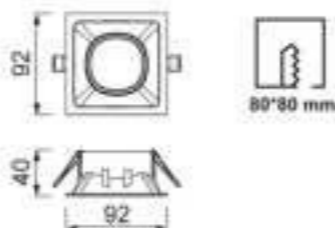

C0160



ErP  
COMPLIANT

RoHS  
COMPLIANT

# BRANDON

Empotrable-Recessed

Indoor

6902



6903

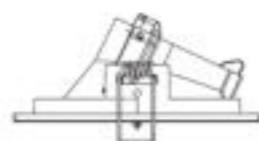
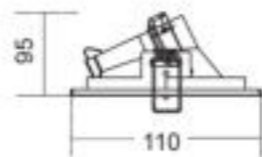

6903



REFERENCE	BULB NO INCLUDED	FINISH
6902	1 x GU10	Blanco mate-Matt white
6903	1 x GU10	Negro Mate-Matt Black
6900	1 x GU10	Blanco mate-Matt white
6901	1 x GU10	Negro Mate-Matt Black

GU10 máx 12W Led 100-240V- 50/60Hz Aluminio-Aluminium



Bombillas recomendadas-Suggested bulbs

K	Wat LED	On/Off	Dimmable	Lumens
2700K	7W	R09254	R09257	510lm
3000K	7W	R09255	R09258	540lm
4000K	7W	R09256	R09259	570lm



6900

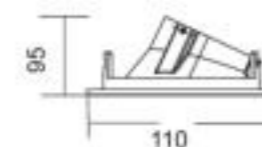

6901

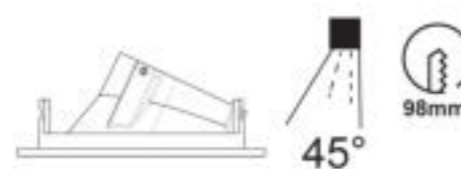



REFERENCE	BULB NO INCLUDED	FINISH
6839	1 x GU10	Blanco mate-Matt white
6840	1 x GU10	Negro mate-Matt black
6843	1 x GU10	Blanco mate-Matt white
6844	1 x GU10	Negro mate-Matt black
6841	1 x GU10	Blanco mate-Matt white
6842	1 x GU10	Negro mate-Matt black
6845	1 x GU10	Blanco mate-Matt white
6846	1 x GU10	Negro mate-Matt black
GU10 máx 12W Led		100-240V- 50/60Hz PCB by samsung



REFERENCE	BULB NO INCLUDED	FINISH
6835	1 x GU10	Blanco mate-Matt white
6837	1 x GU10	Blanco mate-Matt white
6838	1 x GU10	Negro mate-Matt black
GU10 máx 12W Led		100-240V- 50/60Hz PCB by samsung





REFERENCE	K	LED WATT	LUMENS	FINISH
C0083	3000K	7W	490lm	Blanco mate-Matt white
C0084	4000K	7W	520lm	Blanco mate-Matt white
			220-240V~ 50/60Hz CRI:≥ 80	Aluminio-Aluminium

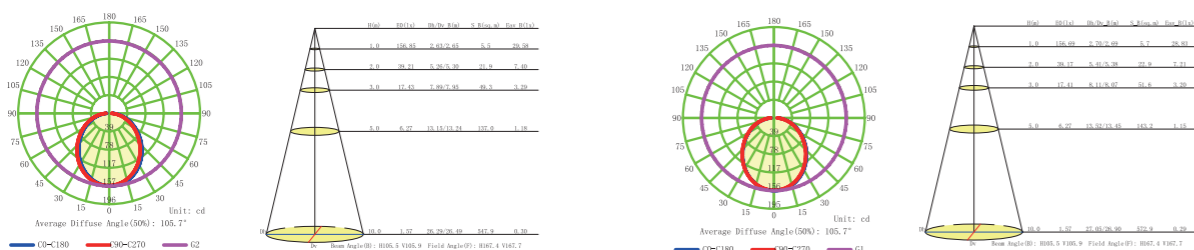
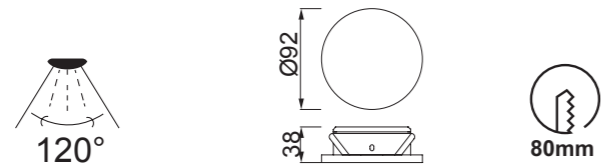





REFERENCE	K	LED WATT	LUMENS	FINISH
C0081	3000K	7W	610lm	Blanco mate - Matt white
C0082	4000K	7W	640lm	Blanco mate - Matt white
220-240V - 50/60Hz CRI > 80				Aluminio - Aluminium

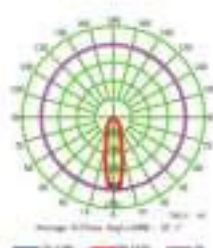
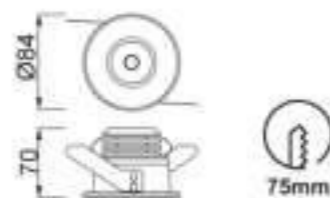

3000K

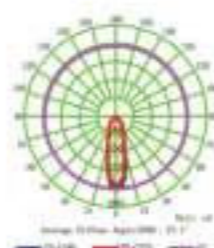
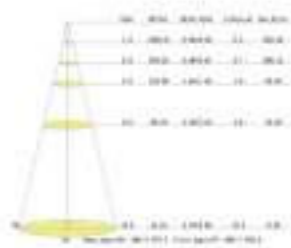

4000K

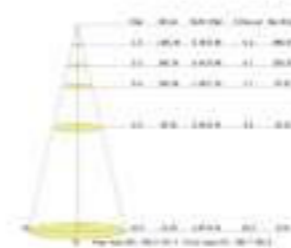



REFERENCE	BULB NO INCLUDED	FINISH
6405	1 x GU10	Blanco mate-Matt white
6406	1 x GU10	Aluminio Plata-Silver Aluminium
GU10 máx 12W Led 100-240V- 50/60Hz		Aluminio-Aluminium



Bombillas recomendadas-Suggested bulbs

K	Wat LED	On/Off	Dimmable	Lumens
2700K	7W	R09254	R09257	510lm
3000K	7W	R09255	R09258	540lm
4000K	7W	R09256	R09259	570lm



6810

6811

6812

6813

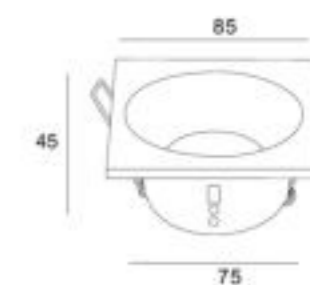
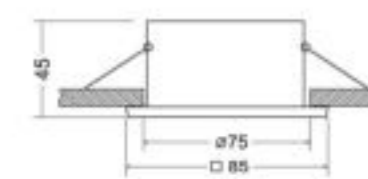
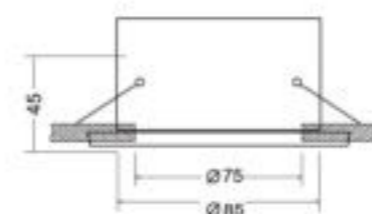

REFERENCE	BULB NO INCLUDED	FINISH	SIZES
6810	1 x GU10	Blanco mate-Matt white	ø 8.5x4.5cm
6811	1 x GU10	Negro mate-Matt black	ø 8.5x4.5cm
6812	1 x GU10	Blanco mate-Matt white	4.5x8.5x8.5cm
6813	1 x GU10	Negro mate-Matt black	4.5x8.5x8.5cm
GU10 máx 12W Led 100-240V- 50/60Hz		Aluminio-Aluminium	



## TIRAS-STRIPS

Tira LED flexible para uso interior IP20  
IP20 Flexible LED strip for indoor lighting

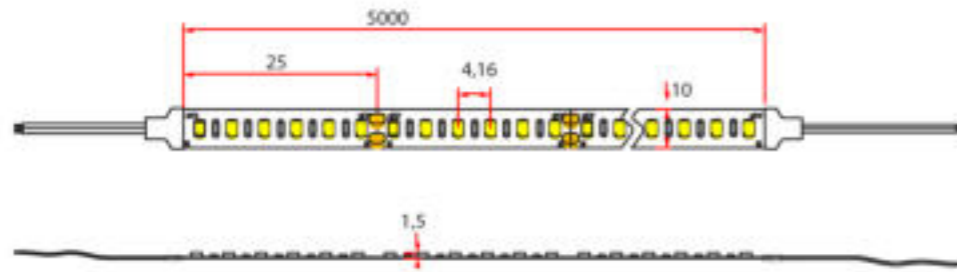

### Características técnicas / Technical characteristics

Ref.	Color Colour	Color temp. Colour T°	Tensión DC voltage DC	Ud. LED metro LED units meter	Potencia por metro Power meter	Eficiencia luminosa metro Luminous efficacy meter	Eficiencia luminosa vatio Luminous efficacy watt	CRI	SDCM	Ancho Wide	Corte Cut	Ud. LED corte LED units cut	Metros rollo Meters reel	Protección Protection
	K	V		W/m	lm/m*	lm/W			mm	mm	pcs	m	IP	
7366	●	2700	24	240	19,2	1400	73	≥ 90	< 3	10	25	6	5	20
7367	●	3000	24	240	19,2	1470	77	≥ 90	< 3	10	25	6	5	20
7368	○	4000	24	240	19,2	1540	80	≥ 90	< 3	10	25	6	5	20



24V CRI: ≥ 90 tc < 65°

## TIRAS-STRIPS

Tira LED flexible para uso interior. IP20  
IP20 Flexible LED strip for indoor use

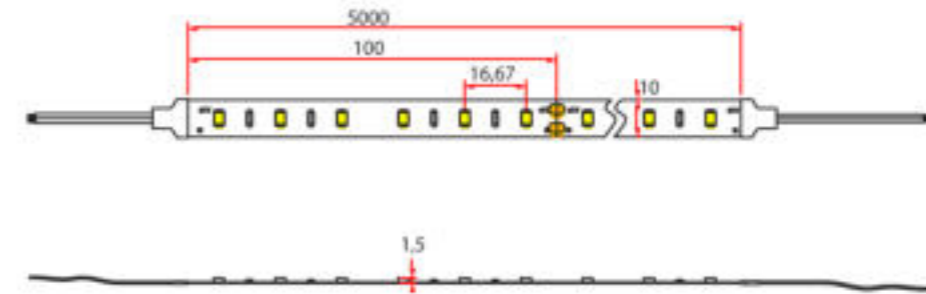
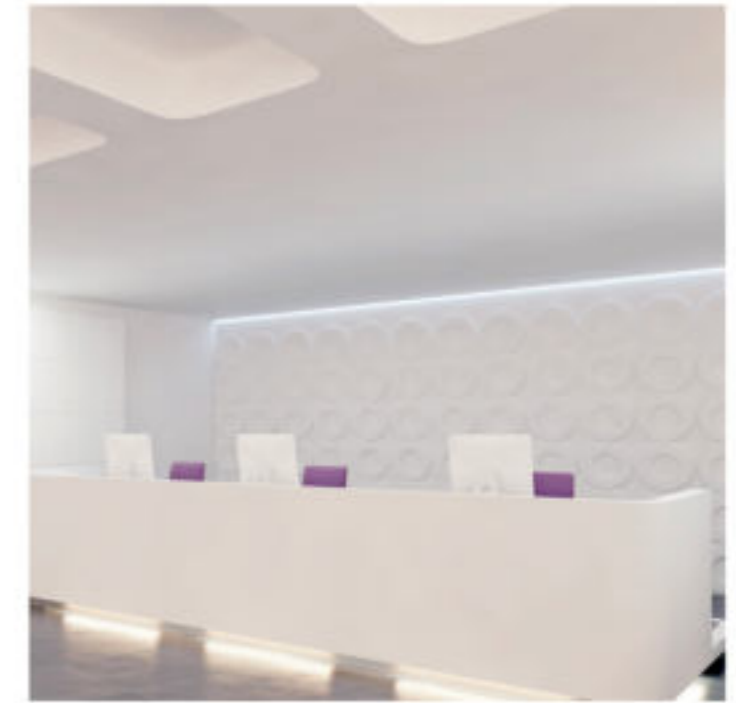

### Características técnicas / Technical characteristics

Ref.	Color Colour	Color temp. Colour T°	Tensión DC voltage DC	Ud. LED metro LED units meter	Potencia por metro Power meter	Eficiencia luminosa metro Luminous efficacy meter	Eficiencia luminosa vatio Luminous efficacy watt	CRI	SDCM	Ancho Wide	Corte Cut	Ud. LED corte LED units cut	Metros rollo Meters reel	Protección Protection
	K	V		W/m	lm/m*	lm/W			mm	mm	pcs	m	IP	
7360	●	2700	24	60	9,6	650	68	≥ 90	< 3	10	100	6	5	20
7361	●	3000	24	60	9,6	685	71	≥ 90	< 3	10	100	6	5	20
7362	○	4000	24	60	9,6	715	74	≥ 90	< 3	10	100	6	5	20



24V CRI: ≥ 90 tc < 65°

## TIRAS-STRIPS

Tira LED flexible para uso interior. IP20  
IP20 Flexible LED strip for indoor use

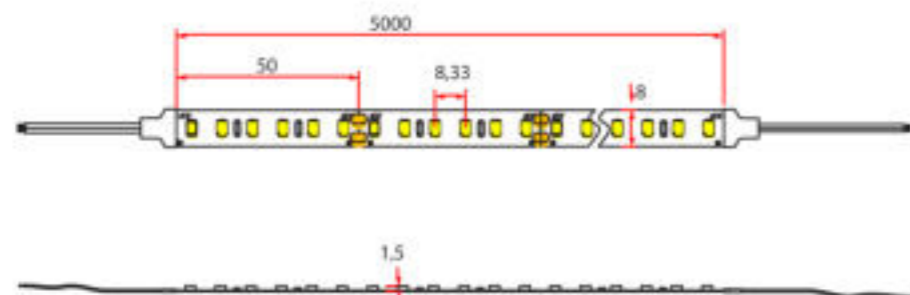

### Características técnicas / Technical characteristics

Ref.	Color Colour	Color temp. Colour T*	Tensión DC voltage DC	Ud. LED metro LED units meter	Potencia por metro Power meter	Eficiencia luminosa metro Luminous efficacy meter	Eficiencia luminosa vatio Luminous efficacy watt	CRI	SDCM	Ancho Wide	Corte Cut	Ud. LED corte LED units cut	Metros rollo Meters reel	Protección Protection
	K	V			W/m	lm/m*	lm/W			mm	mm	pcs	m	IP
7363	●	2700	24	120	14,4	1010	70	≥ 90	< 3	8	50	6	5	20
7364	●	3000	24	120	14,4	1060	74	≥ 90	< 3	8	50	6	5	20
7365	○	4000	24	120	14,4	1110	77	≥ 90	< 3	8	50	6	5	20



24V CRI ≥ 90 tc < 65°

## TIRAS-STRIPS

Tira LED flexible para uso exterior IP65  
IP65 Flexible LED strip for outdoor lighting

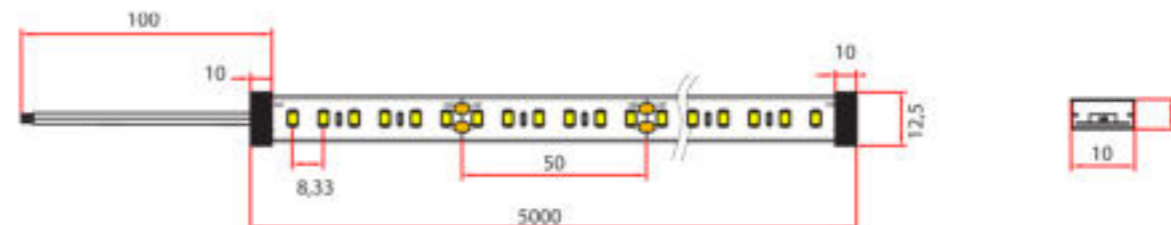
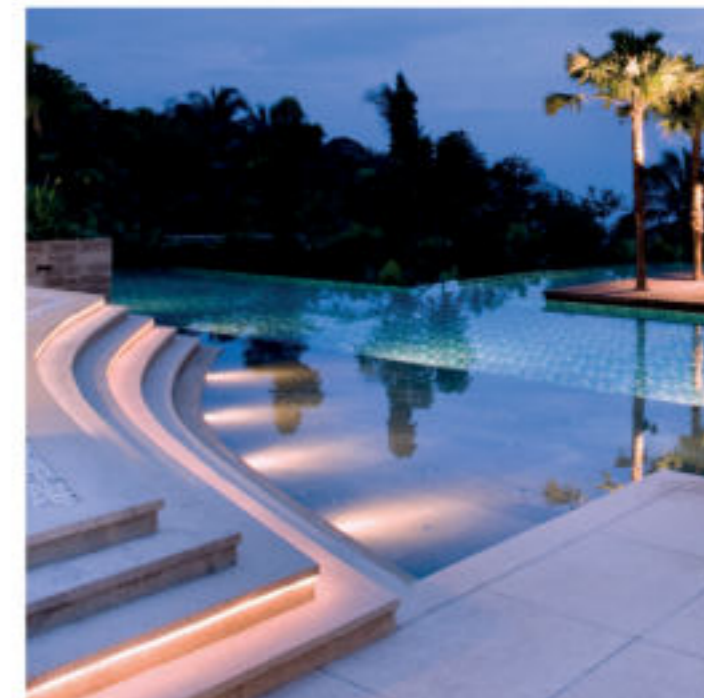

### Características técnicas / Technical characteristics

Ref.	Color Colour	Color temp. Colour T*	Tensión DC voltage DC	Ud. LED metro LED units meter	Potencia por metro Power meter	Eficiencia luminosa metro Luminous efficacy meter	Eficiencia luminosa vatio Luminous efficacy watt	CRI	SDCM	Ancho Wide	Corte Cut	Ud. LED corte LED units cut	Metros rollo Meters reel	Protección Protection
	K	V			W/m	lm/m*	lm/W			mm	mm	pcs	m	IP
7369	●	3000	24	120	14,4	950	66	≥ 90	< 3	10	50	6	5	65
7370	○	4000	24	120	14,4	995	69	≥ 90	< 3	10	50	6	5	65

### Accesorios de corte IP no incluidos / IP Cutting accessories not included



7406 Conexión estanca DC/Waterproof connection



7404 Pegamento silicona/Silicone glue



7403 Final silicona con agujeros  
Silicone end cap w/holes

7405 Final silicona/Silicone End cap



24V CRI ≥ 90 tc < 65°

## PERFILES - PROFILES

Perfil para tiras LED  
Profile for LED strips

Indoor



7381 Blanco-White

7382 Negro-Black

7383 Aluminio-Aluminium

Piezas incluidas/Included pieces

Piezas incluidas/Included pieces

Piezas incluidas/Included pieces



Perfil+difusor/Profile+diffuser

Perfil+difusor/Profile+diffuser

Perfil+difusor/Profile+diffuser



Tapa/End cap



Clip PC transparent



Clip aluminium



Aluminio+PCB/Aluminium+PCB

## PERFILES - PROFILES

Perfil para tiras LED  
Profile for LED strips



7392 Blanco-White

7393 Negro-Black

7394 Aluminio-Aluminium

Piezas incluidas/Included pieces

Piezas incluidas/Included pieces

Piezas incluidas/Included pieces



Perfil+difusor/Profile+diffuser

Perfil+difusor/Profile+diffuser

Perfil+difusor/Profile+diffuser

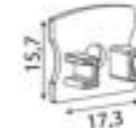

Tapa/End cap



Clip PC transparent



Clip aluminium

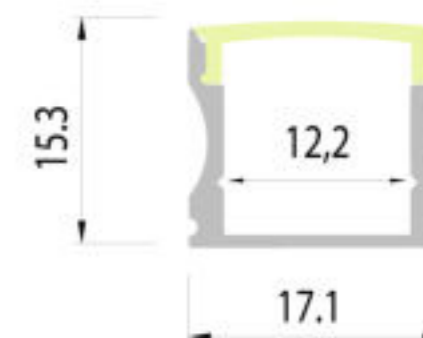

Aluminio+PCB/Aluminium+PCB

## PERFILES - PROFILES

Perfil empotrado para suelo  
LED Strip Profile recessed in ground



8064 Aluminio-Aluminium

Piezas incluidas/Included pieces

2 m



Perfil+difusor/Profile+diffuser

2 x 8065



2 x 8066

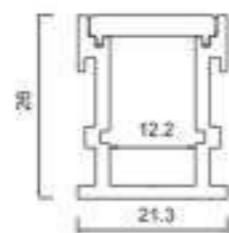

Indoor



Aluminio+PCB/Aluminium+PCB

# PERFILES - PROFILES

Perfil para esquinas  
Profiles for corners

Indoor



7417 Blanco-White

7418 Negro-Black

Piezas incluidas/Included pieces

Piezas incluidas/Included pieces

2 m



2 m



Perfil+difusor/Profile+diffuser

Perfil+difusor/Profile+diffuser

2 x 8060



2 x 8061



2 x 8062



2 x 8063



4 x 7419



4 x 7419

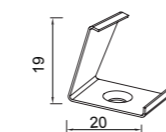
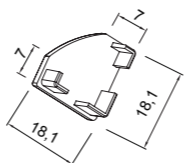
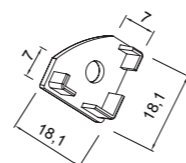
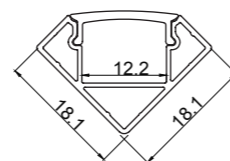

Aluminio+PCB/Aluminium+PCB

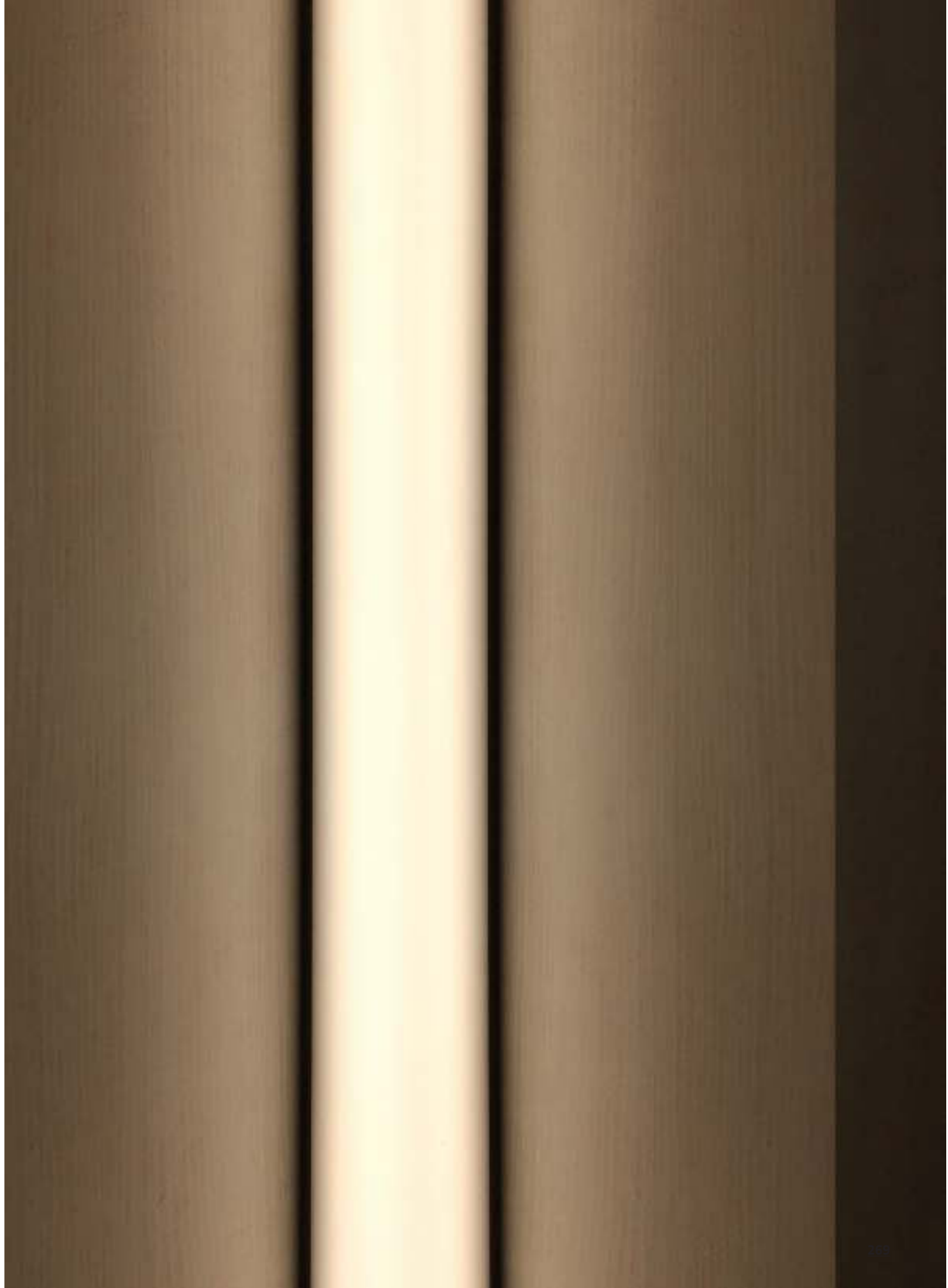

## PERFILES - PROFILES

Perfil empotrable para tiras led  
Recessed profile for led strips



8070 Aluminio-Aluminium

Piezas incluidas/Included pieces:

2 m



Perfil+difusor/Profile+diffuser

2 x 8071



2 x 8072

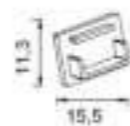
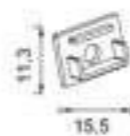
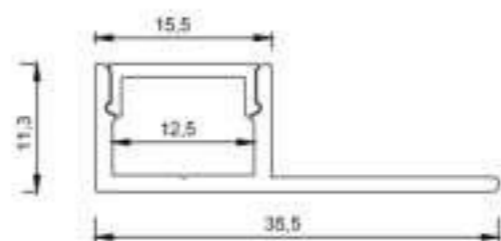

Indoor



Aluminio+PCB/Aluminium+PCB



# PERFILES - PROFILES

Perfil empotrable para tiras led  
Recessed profile for led strips

Indoor



8067 Aluminio-Aluminium

Piezas incluidas/Included pieces

2 m



Perfil+difusor/Profile+diffuser

2 x 8068



2 x 8069

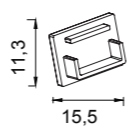
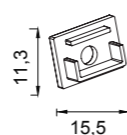
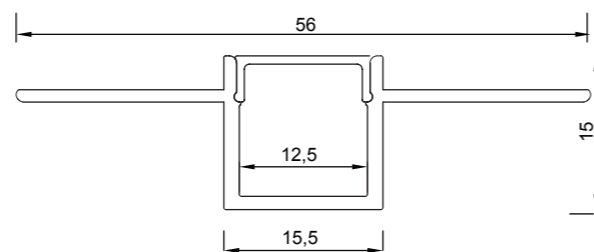

Aluminio+PCB/Aluminium+PCB



## PERFILES-PROFILES

Perfiles Empotrables para tiras LED  
Recessed Profile for LED strips

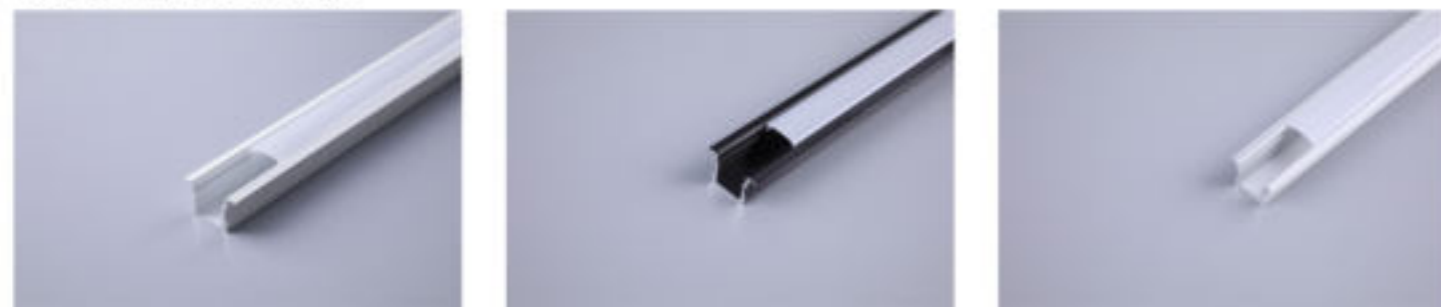

7407 Blanco-White

7408 Negro-Black

7409 Aluminio-Aluminium

Piezas incluidas/Included pieces

Piezas incluidas/Included pieces

Piezas incluidas/Included pieces

2 m



2 m



2 m



Perfil+difusor/Profile+diffuser

Perfil+difusor/Profile+diffuser

Perfil+difusor/Profile+diffuser

2 x 7410



2 x 7411



2 x 7412



2 x 7413



2 x 7414



2 x 7415



4 x 7416



4 x 7416



4 x 7416



Tapa/End cap

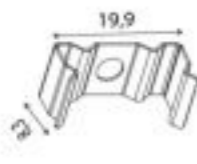

Clip aluminium

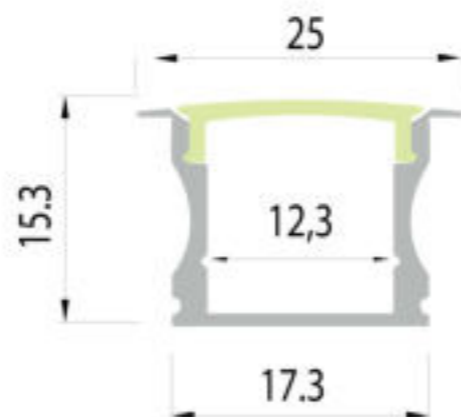

Aluminio+PCB/Aluminium+PCB

Indoor

## ALIMENTADORES-DRIVERS

Tension constante 24v IP67  
IP67 24v Constant voltage

7378



7379



7380

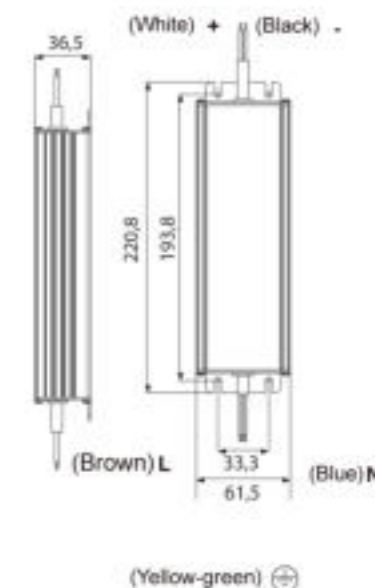
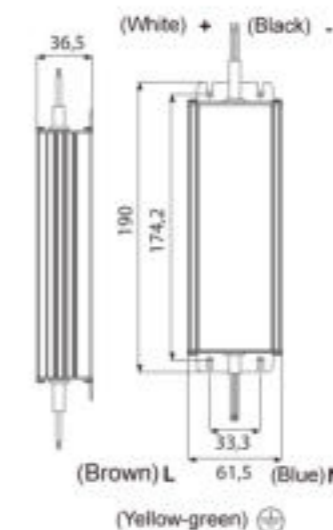

Características técnicas / Technical characteristics

Ref.	Art.-No	Tensión nominal de entrada Nominal input voltage	Rango de potencia en módulo Output power range	Tensión de salida DC Output voltage DC	Corriente de salida máxima Maximum output current	Factor de potencia Power factor	Frecuencia Frequency	Temp. máx. envolvente Max temp.at tc point	Temp. funcionamiento Operating temp.	Protección Protection
		Vac	W	Vdc	A	λ	Hz	tc (°C)	ta (°C)	IP
7378	SPE100-24VLP	200-240V	0-100	24	4.17	≥ 0,95	50/60	90°	-20...+60°	67
7379	SPE150-24VLP	200-240V	0-150	24	6.25	≥ 0,95	50/60	90°	-20...+60°	67
7380	SPE200-24VLP	200-240V	0-200	24	8.33	≥ 0,95	50/60	90°	-20...+60°	67



## ALIMENTADORES-DRIVERS

Tension constante 24v  
24v Constant voltage



Indoor

## ALIMENTADORES-DRIVERS

Tension constante 24v finos  
24v Constant voltage slim



7371

7372

7373

7374

7375

7376

7377

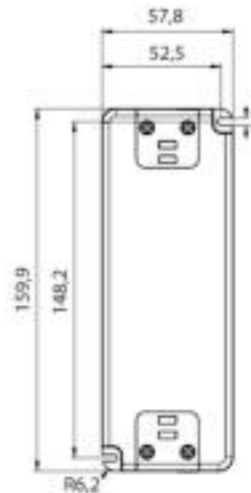
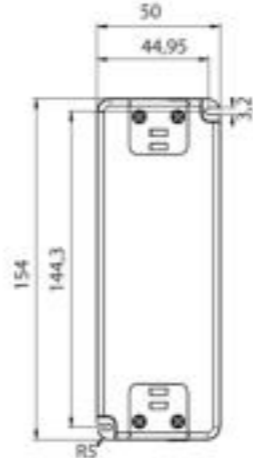
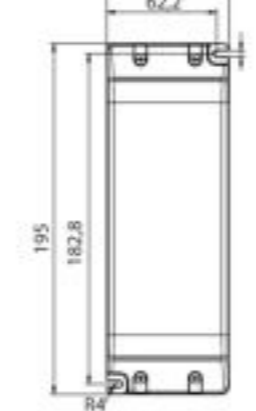
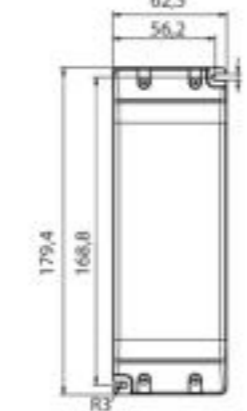
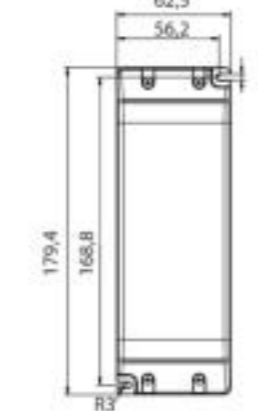
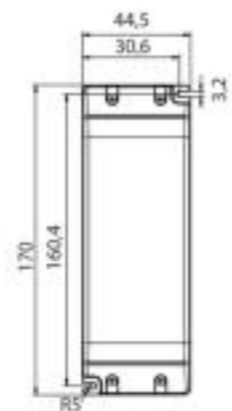
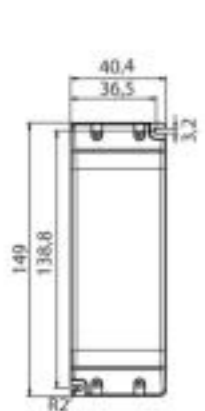
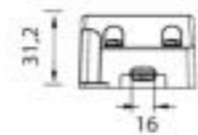

### Características técnicas / Technical characteristics

Ref.	Art.-No	Tensión nominal de entrada Nominal input voltage	Rango de potencia en módulo Output power range	Tensión de salida DC Output voltage DC	Corriente de salida máxima Maximum output current	Factor de potencia Power factor	Frecuencia Frequency	Temp. máx. envolvente Max temp. at tc point	Temp. funcionamiento Operating temp.	Protección Protection
		Vac	W	Vdc	A	$\lambda$	Hz	tc (°C)	ta (°C)	IP
7371	SE30-24VL	200-240V	0-30	24	1.25	$\geq 0,9$	50/60	80°	-20...+45°	20
7372	SE60-24VL	200-240V	0-60	24	2.5	$\geq 0,95$	50/60	90°	-20...+45°	20
7373	SE100-24VL	220-240V	0-100	24	4.17	$\geq 0,95$	50/60	90°	-20...+45°	20
7374	SE150-24VL	220-240V	0-150	24	6.25	$\geq 0,9$	50/60	90°	-20...+45°	20
7375	SNP250-24VL	200-240V	0-250	24	10.4	$\geq 0,95$	50/60	90°	-20...+45°	20

### Características técnicas / Technical characteristics

Ref.	Art.-No	Tensión nominal de entrada Nominal input voltage	Rango de potencia en módulo Output power range	Tensión de salida DC Output voltage DC	Corriente de salida máxima Maximum output current	Factor de potencia Power factor	Frecuencia Frequency	Temp. máx. envolvente Max temp. at tc point	Temp. funcionamiento Operating temp.	Protección Protection
		Vac	W	Vdc	A	$\lambda$	Hz	tc (°C)	ta (°C)	IP
7376	SS30-24VF	220-240V	0-30	24	1.25	$\geq 0,95$	50/60	85°	-20...+45°	20
7377	SS60-24VF	200-240V	0-60	24	2.5	$\geq 0,9$	50/60	80°	-20...+50°	20



# SISTEMAS CONTROL-CONTROL SYSTEMS

Controlador LED DIM-TW  
DIM-TW LED Controller



El controlador PRO-DIMTW-C01 permite controlar la iluminación de una tira LED monocolor o de Blanco Dinámico (TW) desde un mando a distancia.

El controlador puede ser sincronizado con hasta 8 mandos a distancia simultáneamente. Cada mando a distancia puede controlar hasta 4 controladores diferentes de manera autónoma

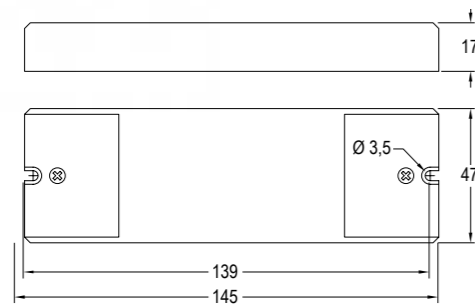

# PRO-DIMTW-C01

PRO-DIMTW-C01 can control single colour (1CH) or Tunable White (2CH) LED Strips from an RF remote control.

The controller could be linked with up to 8 remotes at the same time. Each remote can control 4 controllers independently.

## Accesorios / Accessories

Ref 9955911 PRO-DIM-R01



## Esquema de conexión / Connection diagram

Ref.	Tensiones de entrada y salida Input-output Voltage	Tipo de regulación Control signal	Intensidad máx. de salida Max output current	Potencia máx. de salida Max output power	Tipo tira Led Led strip type	Control a través de Tipo Control made by
	V	mA	A	12V 24V		Mando a distancia RF
9955912	12-24	PWM	3 x 5A DIM 2x 5A TW	60W CH 120 W CH	Monocolor (1CH-DIM) TW (2CH)	RF Remote control

## Modos de control y funcionamiento / Functions and control modes

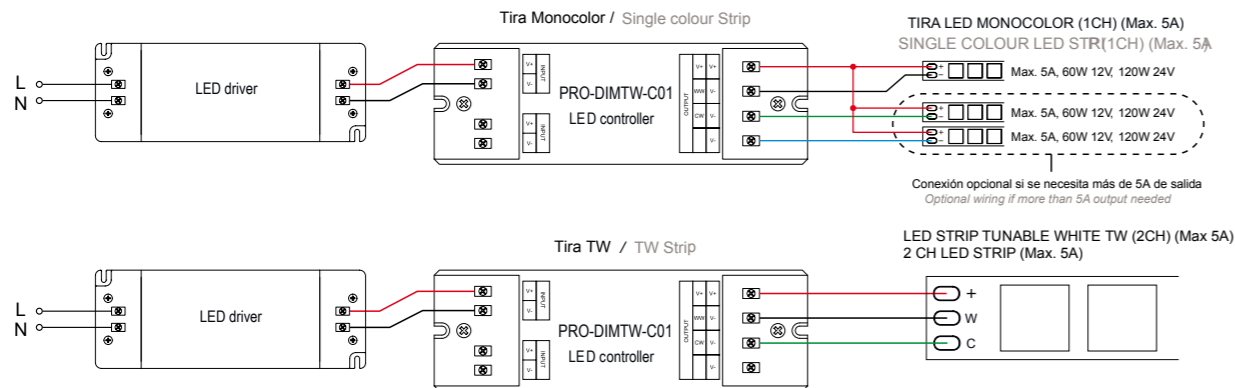

# SISTEMAS CONTROL-CONTROL SYSTEMS

Mando a distancia DIM Monocolor  
DIM Single Colour remote control



El mando PRO-DIM-R01 puede controlar hasta un máximo de 20 receptores.

Permite regular la intensidad de la luz.

Permite controlar hasta 4 zonas independientes.

Cada zona puede ser de uno o más controladores

Permite programar 2 escenas en memoria.

The PRO-DIM-R01 remote control can control a maximum of 20 receivers.

Allows regulation of lighting intensity.

Can control up to 4 independent zones.

Each zone can be with one or more controllers.

Can program 2 saving scenes.

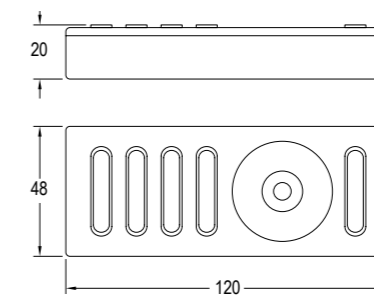

## Accesorios / Accessories

Ref 9955912 PRO-DIMTW-C01



## Características técnicas / Technical characteristics

Ref.	Alimentación Power	Frecuencia de operación Operation frequency	Tipo de tira LED LED strip type	Alcance máx. interior (Sin paredes) Max. Range (Without walls)	Compatible con Compatible with
		Mhz		m	
9955911	3xAAA/LR03 1,5V batteries/ pilas	434/869	TW (2CH) DIM / monocolor (1CH)	20	SPU-DIM-C01

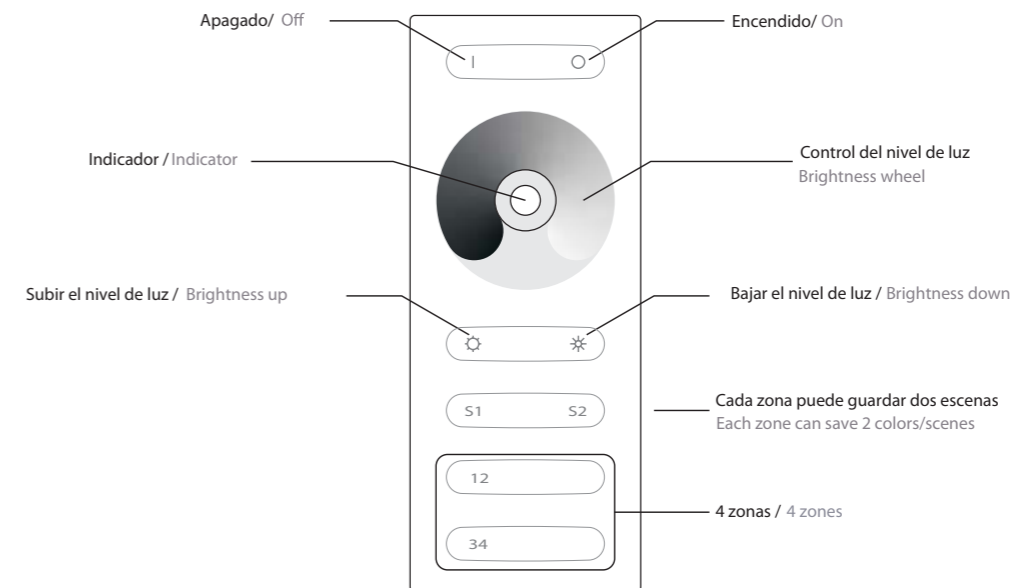

# SISTEMAS CONTROL-CONTROL SYSTEMS

## SPU-DIM-C01

Controlador LED para pulsadores estándar y/o mando a distancia  
LED Controller for standard push switch and/or remote control

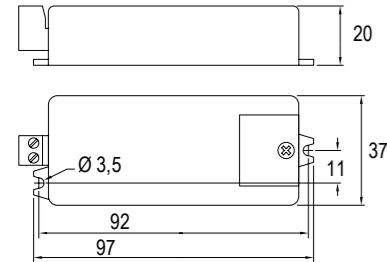

El controlador SPU-DIM-C01 permite controlar la iluminación de una tira LED monocolor desde un pulsador estándar de cualquier fabricante. Pueden controlarse las tiras LED manteniendo la misma familia de mecanismos que en el resto de la instalación en la que se integre.

También puede controlarse con los mecanismos RF SPU. Son mecanismos sin cables de instalación muy sencilla, pegar o atornillar y que funcionan con pila de 3 años de duración. Permite controlar los LEDs fijando el mecanismo en cualquier superficie.

El controlador puede ser gobernado por varios pulsadores (ver esquema de conexión) y hasta 8 mecanismos RF SPU a la vez. Puede funcionar con los dos sistemas de control de manera simultánea (pulsador conectado por cable y mecanismos RF) o sólo con uno de ellos.

STO-DIM-C01 can control single colour LED strips from a standard push switch from any manufacturer. LED strips can be controlled keeping the same kind of switches as the rest of the installation.

It can also be controlled with the RF SPU switches. These switches are wireless, work with a 3-year-life battery and are very easy to install: just screw or stick in any surface.

Controller can be managed by several push switches (see wiring diagram) and up to 8 RF SPU switches at the same time. It can work with two control systems (standard switches or RF switches) simultaneously or only with one of them.

### Características técnicas / Technical characteristics

Ref.	Tensiones de entrada y salida Input-output Voltage	Tipo de regulación Control signal	Intensidad máx. de salida Max output current	Potencia máx. de salida Max output power	Tipo tira Led Led strip type	Control a través de Tipo Control made by
	V	mA	A	12V 24V 36V		Pulsador standard y/o mecanismo RF
9955901	12-24-36	PWM	1x8	96 W 192 W 288 W	MONOC. DIM (1CH)	Standard push switch and/or RF Switch

### Modos de control y funcionamiento / Functions and control modes

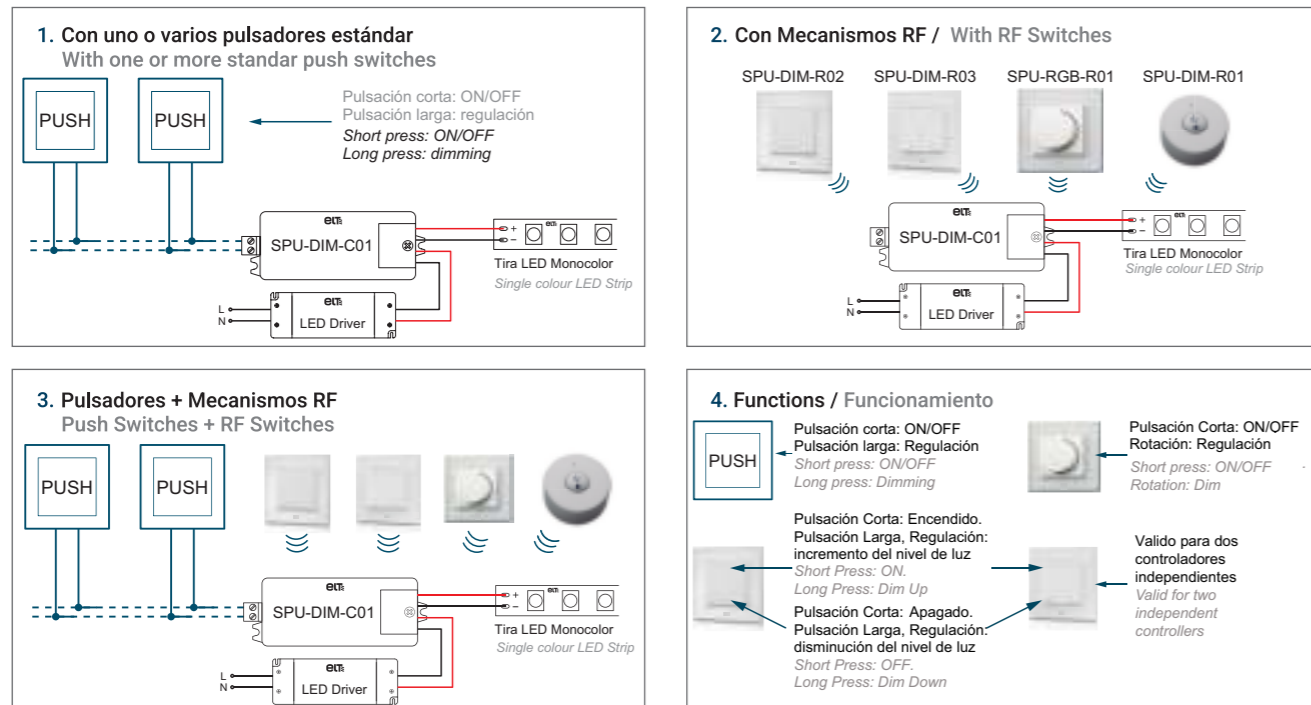

# SISTEMAS CONTROL-CONTROL SYSTEMS

## SPU-DIM-R01

Mecanismo RF  
RF Switch PUSH SYSTEM



Mecanismo RF pequeño y versátil que permite encender, apagar y regular una instalación de tira LED monocolor.

Puede ser fijado a una pared mediante tornillos o pegado (cinta de doble cara incluida). También lleva un imán para fijarse con facilidad en superficies metálicas.

Su reducido tamaño permite que pueda ser llevado en un bolsillo como mando a distancia. Está alimentado por una pila de tipo CR2025 de larga duración.

Fijación: Tornillos / iman.

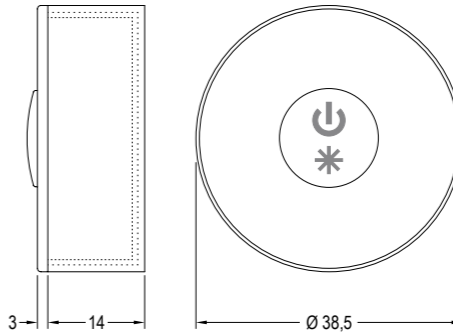

Small and versatile RF switch which allows to swithc ON/OFF and dim a single colour LED strip.

Can be easily fixed to a wall with screws or sticked (double side tape included). Also comes with a small magnet to be fixed easily on metallic surfaces.

Its small size allows to take it in a pocket as a remote control. It 's powered with a long life CR2025 battery.

Fixing: Screw / magnet.

Controlador compatible /  
Controller compatible with

Ref 9955901 SPU-DIM-C01



### Características técnicas / Technical characteristics

Ref.	Alimentación Power	Frecuencia de operación Operation frequency	Tipo de tira LED LED strip type	Alcance máx. interior (Sin paredes) Max. Range (Without walls)	Compatible con Compatible with
		Mhz		m	
9955905	CR2025 3V battery / pila	434/869	DIM (1CH)	30	SPU-DIM-C01

### Características técnicas / Technical characteristics

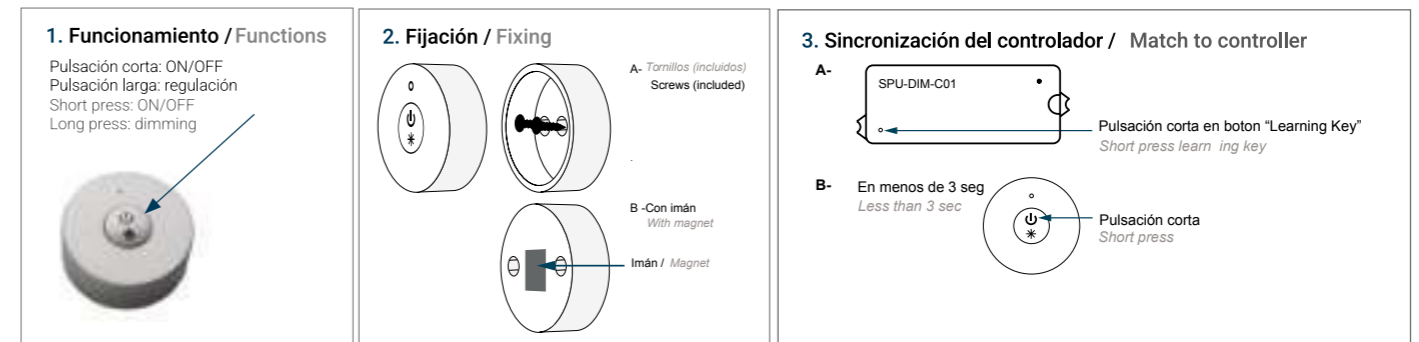

## SISTEMAS CONTROL-CONTROL SYSTEMS

Digital dimmer, 1 dirección digital, 4 canales  
Digital dimmer, 1 digital address, 4 channels

## DAL-MULTI-C02

12-36V DC

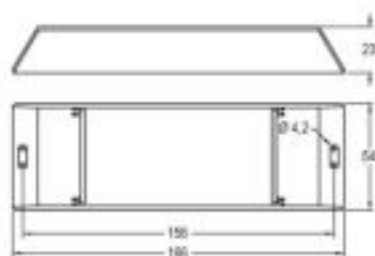

Permite la regulación de tiras LED desde cualquier sistema de control compatible con protocolo DALI. Sólo necesita conexión al bus DALI y asignar al controlador la dirección DALI desde la que se hará el control de las tiras.

Control de tiras LED monocolor.

Incluye pantalla y botones para ver y asignar fácilmente la dirección DALI.

El mismo modelo es válido para pilotar de 1 a 4 canales de forma sincronizada. Cada canal de salida tiene una capacidad de 5A.

0-100% rango de regulación según curva.

This device allows to control LED strips from any control system compatible with DALI protocol. Only needs a connexion to the DALI bus and assign the device the DALI address to control the strips.

Control of LED single colour strips.

Includes screen and buttons to see and assign easily the DALI address.

The same model works from 1 to 4 channel synchronously. Each channel has a current output of 5A

0-100% dimming range via logarithmic curve.

### Características técnicas / Technical characteristics

Ref.	Tensiones de entrada y salida Input-output Voltage	Tipo de regulación Control signal	Intensidad máx. de salida Max output current	Potencia máx. de salida Max output power	Tipo tira Led Led strip type	Control a través de Tipo Control made by
	Vdc	mA	A	12V 24V 36V		
9955921	12-24-36	PWM	4 ch x 5A	240 W 480 W 720 W (4 x 60) (4 x 120) (4 x 180)	DIM	DALI

### Esquema de conexión / Connection diagram

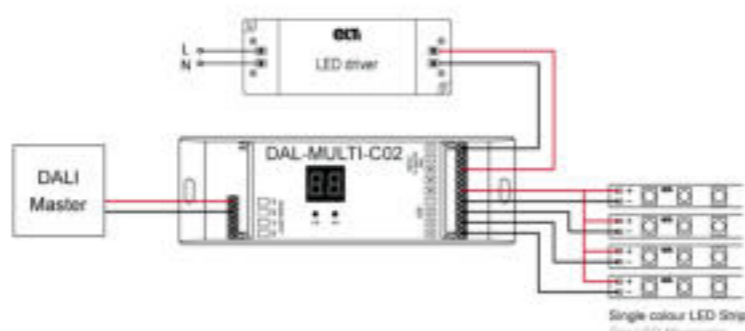

## SISTEMAS CONTROL-CONTROL SYSTEMS

Controlador LED para pulsadores estándar y/o mando a distancia  
LED Controller for standard push switch and/or remote control

## EBLUE MULTI4

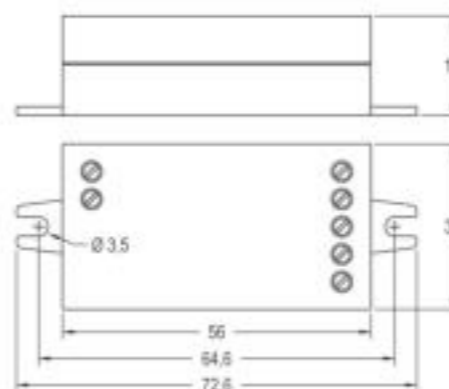

eBLUE MULTI4 es un regulador PWM de cuatro canales controlable por Bluetooth para cargas LED de tensión constante, tales como tiras y módulos LED de tensión constante.

eBLUE MULTI4 puede controlar hasta cuatro canales. La corriente de salida máxima es 6A, la cual puede ser dividida libremente entre 1-4 canales.

Dimensiones muy reducidas para su instalación.

Protegido contra sobrevoltajes, sobre corriente y cortocircuitos.

Controlable de forma inalámbrica a través de un dispositivo inteligente (smartphones / tablets.) Visual e intuitiva app para smartphones / tablets. Disponible gratuitamente en Apple Store / Google Play. app CASAMBI

Forma automáticamente una rápida y segura red inalámbrica de malla con otras unidades eBLUE (hasta 127 unidades / red).

Permite una programación horaria de escenas. Servicio en la nube.

El firmware del dispositivo puede ser actualizado en funcionamiento de manera inalámbrica. Sección máxima en diemas 0,75-1,5 mm<sup>2</sup>.

BLUE MULTI4 is a Bluetooth controllable four channel PWM dimmer for constant voltage LED loads, such as LED strips and constant voltage LED modules.

eBLUE MULTI4 can control up to four channels. The maximum combined output current 6A which can be freely divided between 1-4 CH.

Very small size for easy installation.

Protected against overvoltage, overcurrent and short circuit situations.

Wirelessly controllable with a smart device (smartphone, tablet.) Intuitive and visual app for smartphones / tablets. Available for free on Apple Store / Google Play. CASAMBI

Forms automatically a fast and secure wireless mesh network with other eBLUE devices (up to 127 units / network).

Use timers to turn on and off scene at predefined times.

Cloud service that enhances user experience. Device firmware can be updated over the air. Max terminal section 0.75-1.5 mm<sup>2</sup>

### Características técnicas / Technical characteristics

Ref.	Tensiones de entrada y salida Input-output Voltage	Tipo de regulación Control signal	Intensidad máx. de salida Max output current	Potencia máx. de salida Max output power	Temp. máx. envoltorio Max. temp at tc point	Temp. funcionamiento Operatin temp.	Control a través de Tipo Control made by
	Vdc	mA	A	12V 24V	tc (°)	ta (°)	
9953074	12-24	PWM	6	72 W 144 W	+75	-20...+45	DIM, TW, RGB, RGBW

### Esquema de conexión / Connection diagram

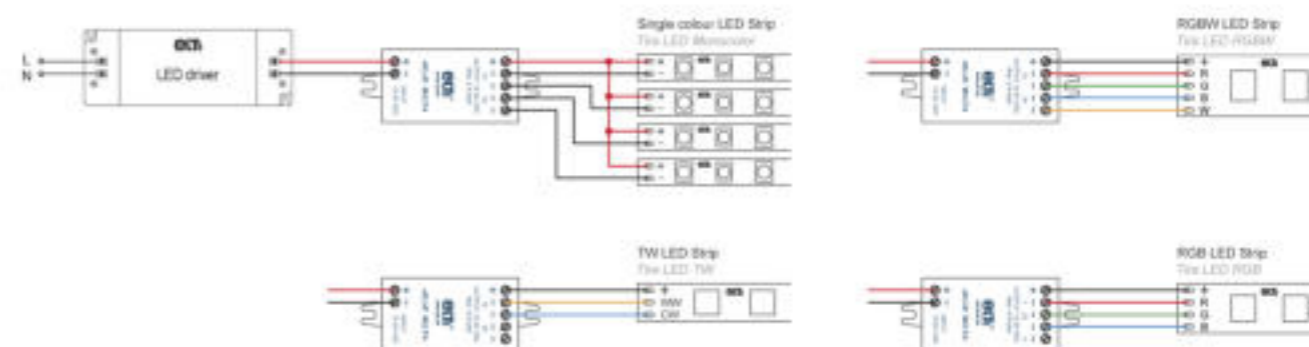

# URANO 150W 4000K

Campanas Led  
Ufo boys Led

Indoor



7420 60°



7421 90°



7422 120°

Luminous Intensity Distribution Curve

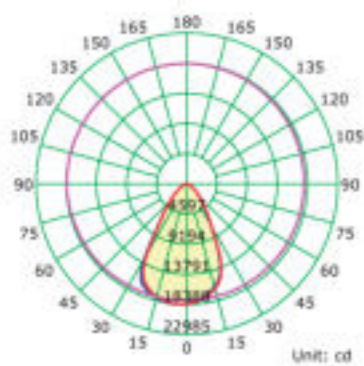

Average Diffuse Angle(50%): 60.4°  
— C0-C180 — C90-C270 — G6

Illuminance at a Distance



Luminous Intensity Distribution Curve

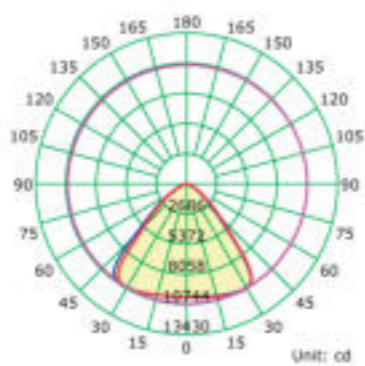

Average Diffuse Angle(50%): 88.4°  
— C0-C180 — C90-C270 — G28

Illuminance at a Distance



Luminous Intensity Distribution Curve

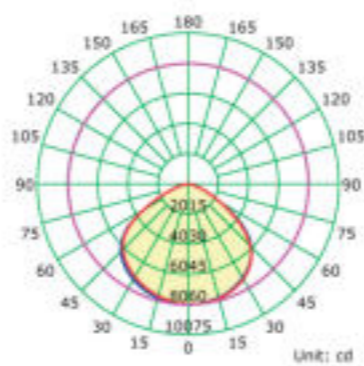

Average Diffuse Angle(50%): 112.0°  
— C0-C180 — C90-C270 — G0

Illuminance at a Distance

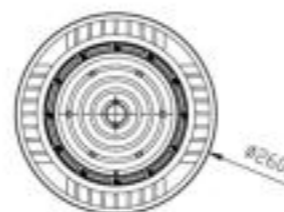
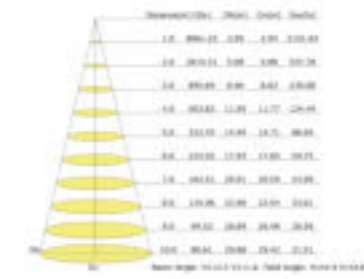

REFERENCE	K	LED WATT	BEAM ANGLE	LUMENS	FINISH
7420	4000K	150W	60°	21000lm	Negro-Black
7421	4000K	150W	90°	21000lm	Negro-Black
7422	4000K	150W	120°	21000lm	Negro-Black
180-260V~ 50/60Hz CRI≥ 80					Aluminio-Aluminium



# URANO 150W 5000K

Campanas Led  
Ufo boys Led

Indoor



7423 60°



7424 90°



7425 120°

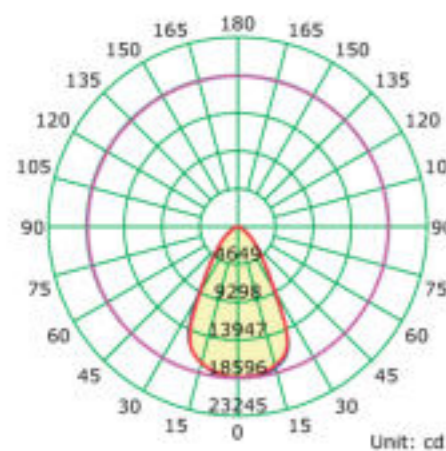

Illuminance at a Distance

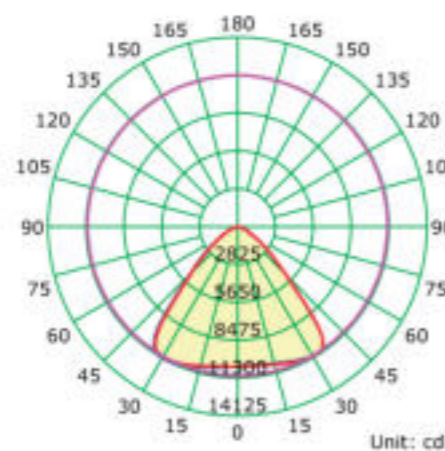
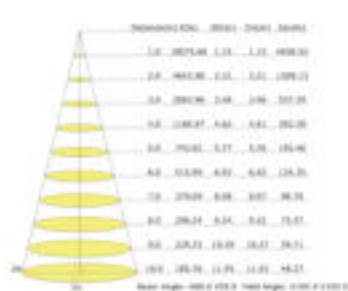

Illuminance at a Distance

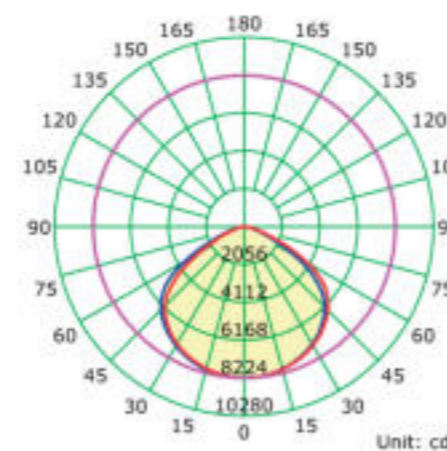

Illuminance at a Distance

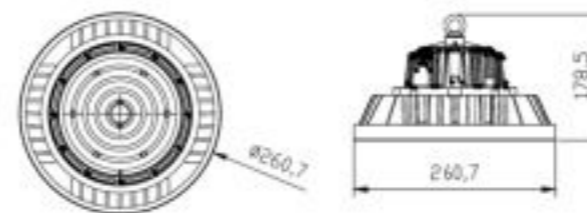
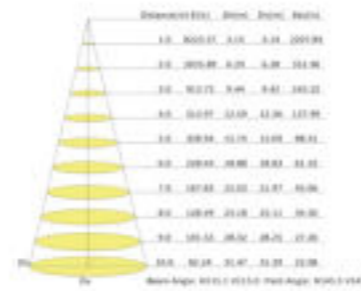

REFERENCE	K	LED WATT	BEAM ANGLE	LUMENS	FINISH
7423	5000K	150W	60°	22500lm	Negro-Black
7424	5000K	150W	90°	22500lm	Negro-Black
7425	5000K	150W	120°	22500lm	Negro-Black
180-260V - 50/60Hz CRI: 80					Aluminio-Aluminium





# URANO 200W 4000K

Campanas Led  
Ufo bays Led

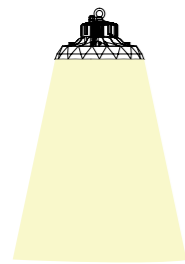

7426 60°

Luminous Intensity Distribution Curve

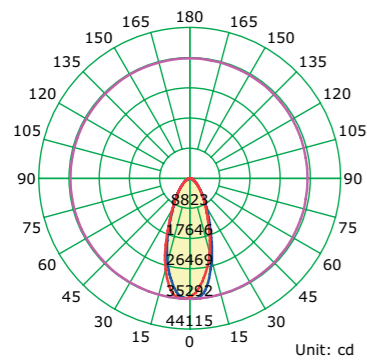

Unit: cd  
Average Diffuse Angle(50%): 42.0°  
— C0-C180 — C90-C270 — G1

Iluminance at a Distance

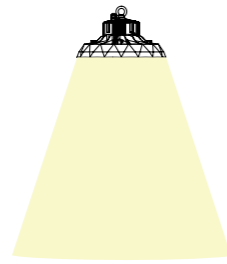
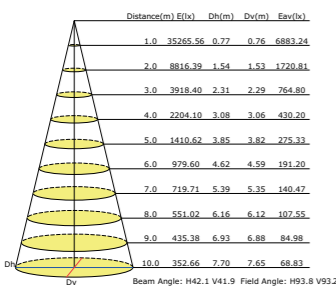

7427 90°

Luminous Intensity Distribution Curve

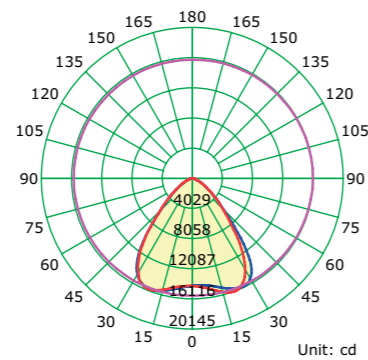

Unit: cd  
Average Diffuse Angle(50%): 82.8°  
— C0-C180 — C90-C270 — G20

Iluminance at a Distance

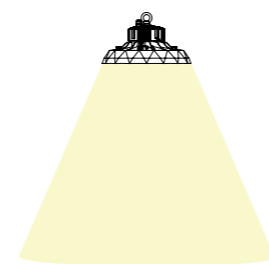
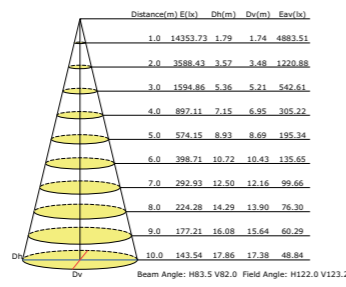

7428 120°

Luminous Intensity Distribution Curve

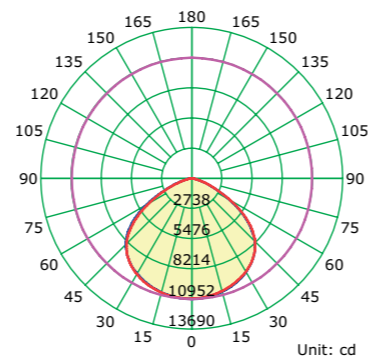

Unit: cd  
Average Diffuse Angle(50%): 112.9°  
— C0-C180 — C90-C270 — G0

Iluminance at a Distance

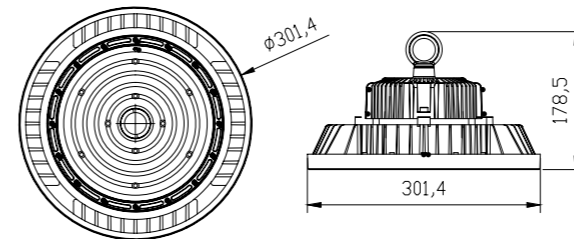
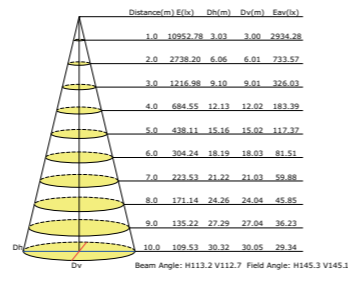

REFERENCE	K	LED WATT	BEAM ANGLE	LUMENS	FINISH
7426	4000K	200W	60°	28000lm	Negro-Black
7427	4000K	200W	90°	28000lm	Negro-Black
7428	4000K	200W	120°	28000lm	Negro-Black
180-260V~ 50/60Hz CRI≥ 80					Aluminio-Aluminium



# URANO 200W 5000K

Campanas Led  
Ufo bays Led

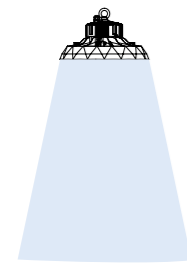

7429 60°

Luminous Intensity Distribution Curve

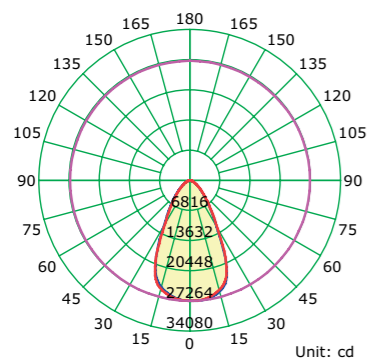

Unit: cd

Average Diffuse Angle(50%): 56.8°

— C0-C180 — C90-C270 — G5

Illuminance at a Distance

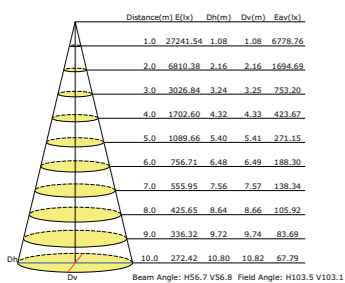

Beam Angle: H56.7 V56.8 Field Angle: H103.5 V103.1

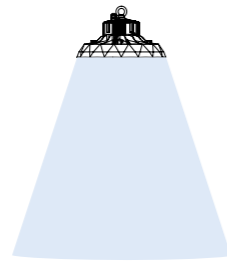

7430 90°

Luminous Intensity Distribution Curve

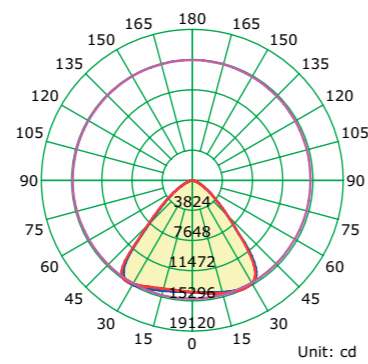

Unit: cd

Average Diffuse Angle(50%): 88.1°

— C0-C180 — C90-C270 — G31

Illuminance at a Distance

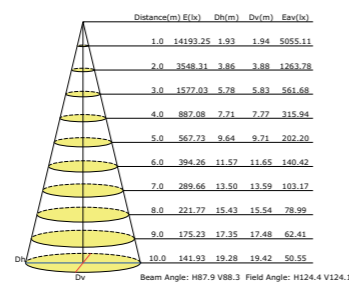

Beam Angle: H87.9 V88.3 Field Angle: H124.4 V124.1

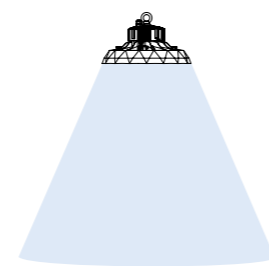

7431 120°

Luminous Intensity Distribution Curve

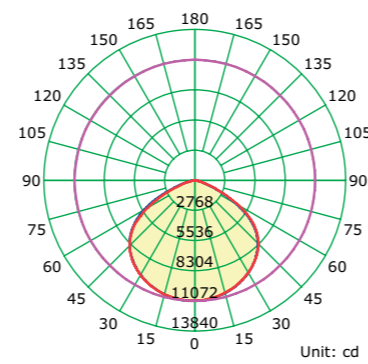

Unit: cd

Average Diffuse Angle(50%): 116.1°

— C0-C180 — C90-C270 — G1

Illuminance at a Distance

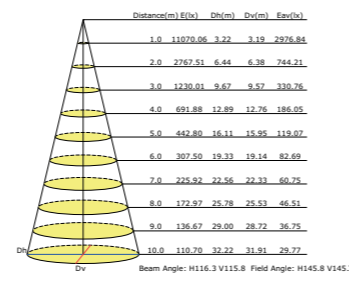

Beam Angle: H116.3 V115.8 Field Angle: H145.8 V145.7

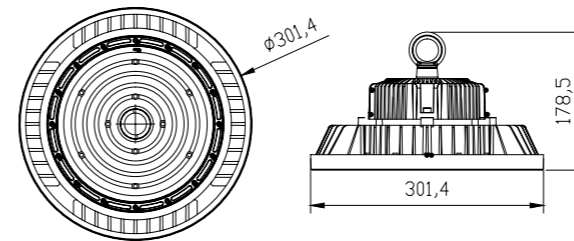

REFERENCE	K	LED WATT	BEAM ANGLE	LUMENS	FINISH
7429	5000K	200W	60°	30000lm	Negro-Black
7430	5000K	200W	90°	30000lm	Negro-Black
7431	5000K	200W	120°	30000lm	Negro-Black
					180-260V~ 50/60Hz CRI≥ 80
					Aluminio-Aluminium





REFERENCE	K	LED WATT	LUMENS	FINISH
New 8152	3000K	6W	550lm	Blanco-White
New 8153	3000K	6W	550lm	Gris Oscuro-Dark grey
New 8154	3000K	6W	550lm	Negro-Black
220-240V~ 50/60Hz CRI ≥80				Aluminio-Aluminium

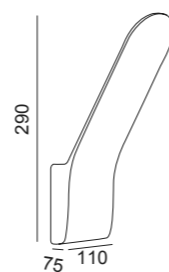
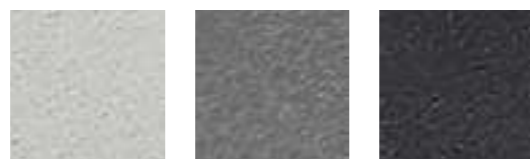

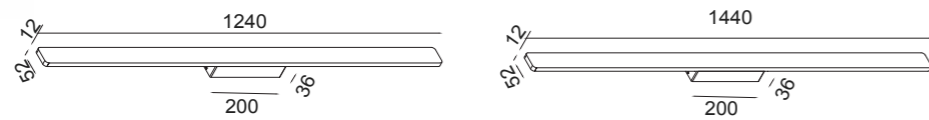

REFERENCE	K	LED WATT	LUMENS	FINISH
New 7990	3000K	20W	1900lm	Blanco-White
New 7991	3000K	20W	1900lm	Gris Oscuro-Dark grey
New 7992	3000K	20W	1900lm	Negro-Black
New 7993	3000K	20W	1900lm	Corten-Corten
New 7994	3000K	24W	2300lm	Blanco-White
New 7995	3000K	24W	2300lm	Gris Oscuro-Dark grey
New 7996	3000K	24W	2300lm	Negro-Black
New 7997	3000K	24W	2300lm	Corten-Corten
220-240V ~ 50/60Hz CRI ≥80				Aluminio-Aluminium

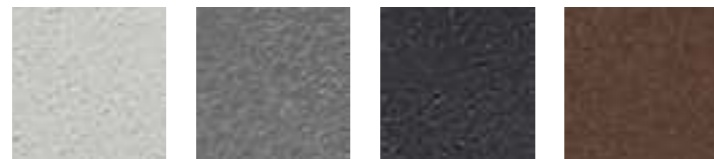

# BERET

Apliques exterior-Outdoor wall lights

Outdoor

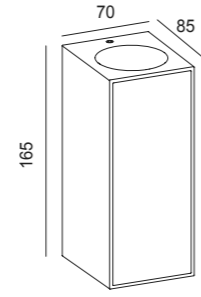

REFERENCE	BULB (No incl)	FINISH
New 7929	2L x GU10	Gris Oscuro/madera-Dark Grey/wood
máx. 10W LED (No incl)	100-240V~ 50/60Hz	Aluminio/Cristal/Madera-Aluminium/Glass/SPC Wood



REFERENCE	BULB NO INCLUDED	FINISH
New 7928	1L x E27	Gris Oscuro/madera-Dark Grey/wood
máx. 15W LED (No incl)	100-240V~ 50/60Hz	Aluminio/PC/Madera-Aluminium/Opal PC/SPC Wood

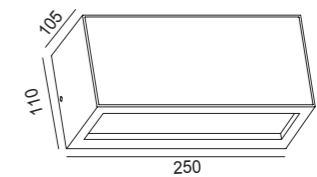



REFERENCE	K	LED WATT	LUMENS	FINISH
6540	3000K	6W	620lm	Gris oscuro-Dark grey
6541	3000K	6W	620lm	Arena blanco-Sand white
New 7813	3000K	8W	830lm	Gris oscuro-Dark grey
New 7814	3000K	8W	830lm	Arena blanco-Sand white
220-240V~ 50/60Hz				Aluminio cristal-Aluminium glass





REFERENCE	K	LED WATT	LUMENS	FINISH
6850	3000K	10W	800lm	Gris + madera-Grey + wood
6851	3000K	12W	960lm	Gris + madera-Grey + wood
110-240V~ 50/60Hz CRI ≥80				Aluminio-Aluminium

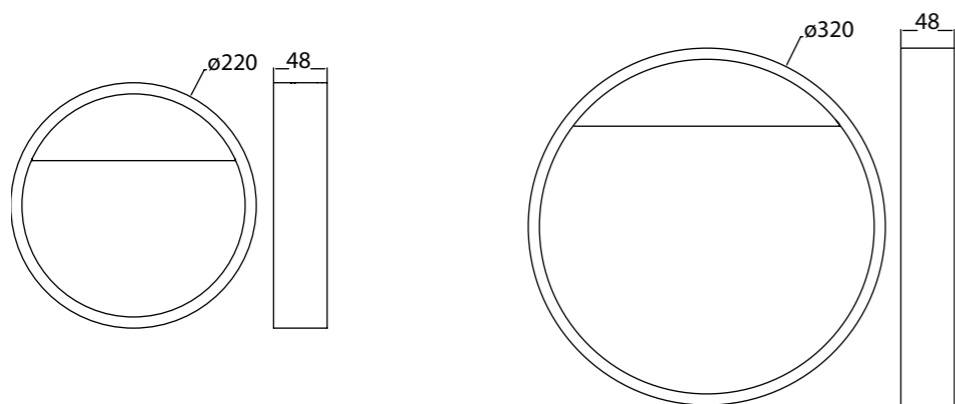



REFERENCE	BULB NO INCLUDED	FINISH
7133	1L + E27	Beige oscuro-Dark beige
	máx. 20W LED (No incl)	100-240V - 50-60Hz
Aluminio/fibra textil sintética-Aluminium/synthetic textile fibre		

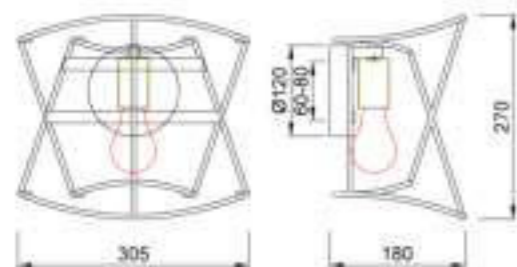

7133  
pág. 372

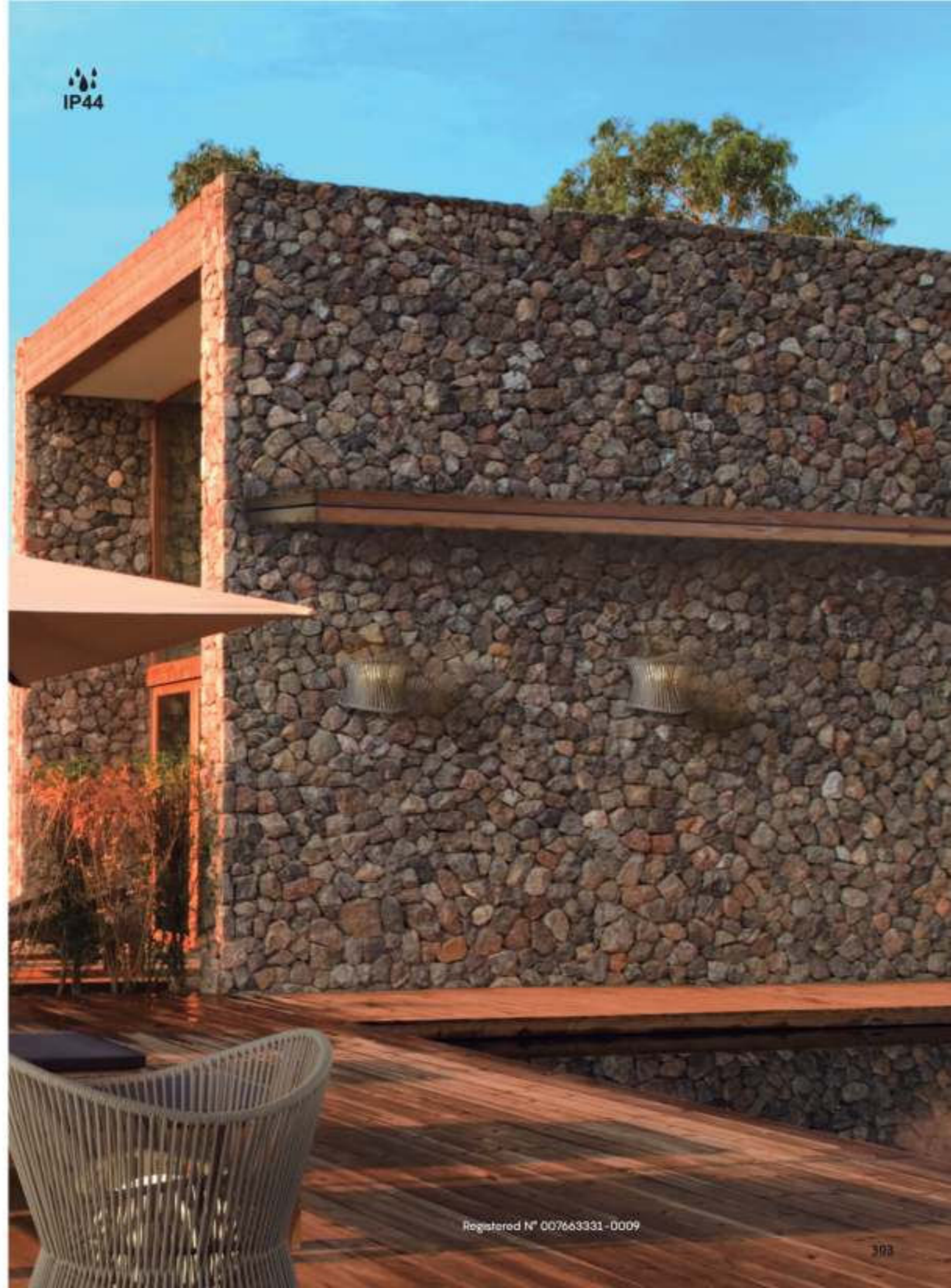



# MAYA

by José Ignacio Ballester

Appliques exterior-Outdoor wall lights

Outdoor

OAMI 005818614-0005



REFERENCE	BULB NO INCLUDED	FINISH
6551	1L - E27	Gris oscuro-Dark grey
6552	1L - E27	Gris oscuro-Dark grey
máx. 20W LED (No incl)		100-240V- 50/60Hz Aluminio/cristal-Aluminium/glass

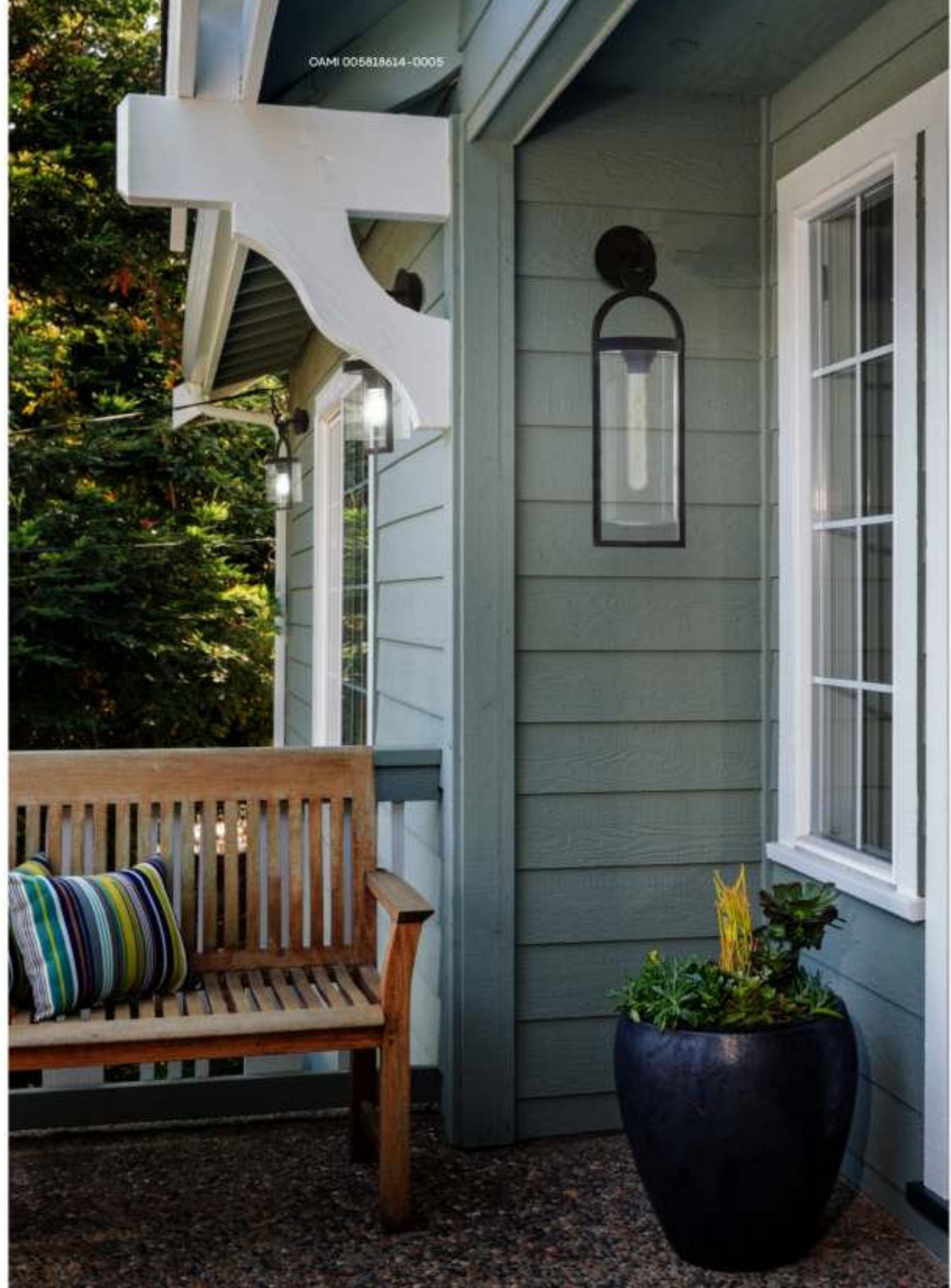



IP54



IP65

REFERENCE	K	LED WATT	LUMENS	FINISH	SENSOR	IP
6774	3000K	15W	1120lm	Gris Oscuro/Madera-Dark Grey/Wood	*	54
6770	3000K	13W	980lm	Gris Oscuro/Madera-Dark Grey/Wood		65
		100-240V~ 50/60Hz CRI:≥ 80		Aluminio/PC-Aluminium/PC		

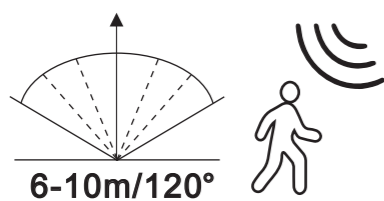
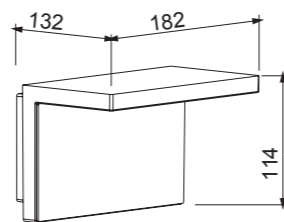
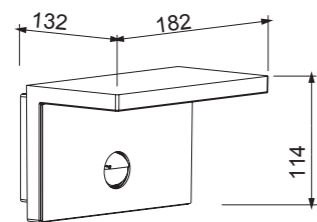

6771  
pág. 412





6495



6494



REFERENCE	BULB NO INCLUDED	FINISH
6495	1L • E27	Grafita-Graphite
6494	1L • E27	Grafita-Graphite
máx. 20W LED (No incl)		100-240V - 50/60Hz Aluminio/cristal-Aluminium/glass



7066  
pág. 340



7085  
pág. 406



6490  
pág. 406



6495



6492



6493



REFERENCE	BULB NO INCLUDED	FINISH
6492	2L • E27	Grafita-Graphite
6493	2L • E27	Grafita-Graphite
máx. 20W LED (No incl)		100-240V - 50/60Hz Aluminio/cristal-Aluminium/glass

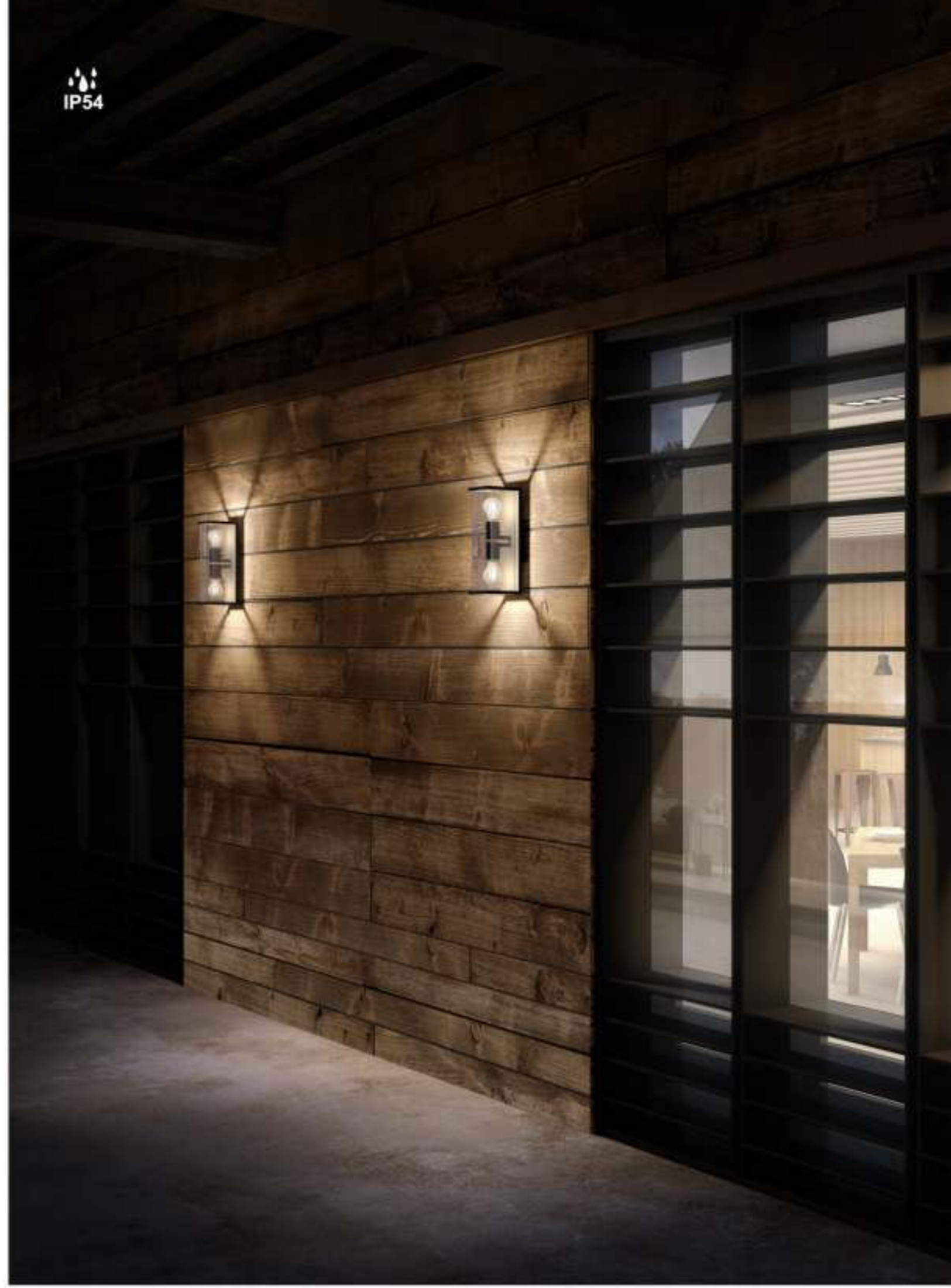

# TEJA

by Santolaria & Lluscà

Apliques exterior-Outdoor wall lights

Outdoor



OAMI 005818614-0007

REFERENCE	BULB NO INCLUDED	FINISH
6508	1L x E27	Blanco-White
	máx. 20W LED (No incl)	100-240V ~ 50/60Hz Polietileno-Polyethylene

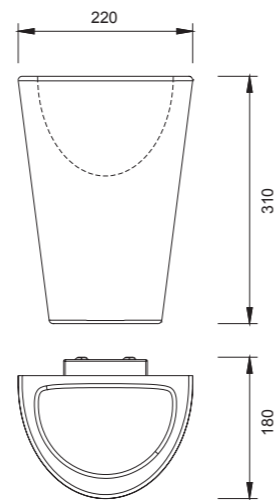

# VOLCANO

Apliques exterior-Outdoor wall lights

Outdoor

IP65

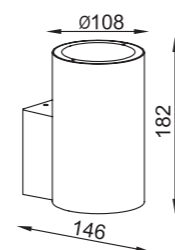
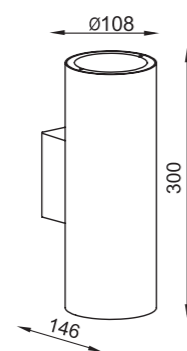

REFERENCE	BULB NO INCLUDED	FINISH
6482	2L x E27	Grafito-Graphite
6483	1L x E27	Grafito-Graphite
máx. 20W LED (No incl)		100-240V - 50/60Hz Aluminio/cristal-Aluminium/glass



7908  
pág. 360



# IGUAZÚ

by José Ignacio Ballester

Appliques exterior-Outdoor wall lights



Outdoor

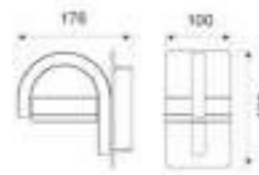

REFERENCE	BULB (No incl)	FINISH
6558	1L x GX53	Gris oscura-Dark grey
6559	1L x GX53	Blanca-White
máx. 10W LED (No incl)		100-240V - 50/60Hz Aluminio-Aluminum



Bombillas recomendadas-Suggested bulbs

REFERENCE	Wattios LED	CCT	Lumens	Ángulo luz
 R09224	9W	3000K	730lm	120°
 R09225	9W	4000K	740lm	120°

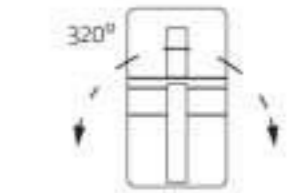

Luz orientable-Orientable light



# IGUAZÚ

by José Ignacio Ballester

Appliques exterior-Outdoor wall lights

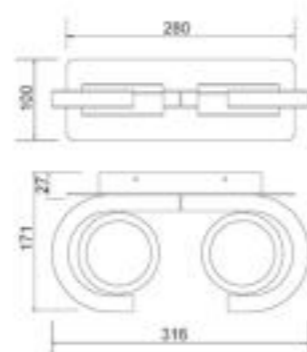
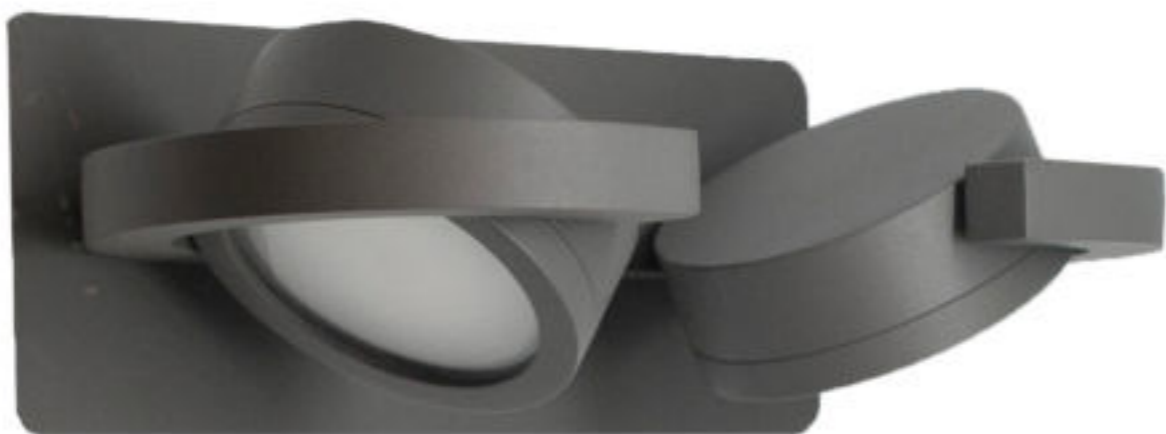

Outdoor



REFERENCE	BULB (No incl)	FINISH
6769	2L x GX53	Gris oscuro-Dark grey
6768	2L x GX53	Blanco-White
máx. 10W LED (No incl)		100-240V-50/60Hz Aluminio-Aluminium



Bombillas recomendadas-Suggested bulbs

REFERENCE	Wattios LED	CCT	Lumens	Ángulo luz
 R09224	9W	3000K	730lm	120°
 R09225	9W	4000K	740lm	120°







7470



7471



7472



7473

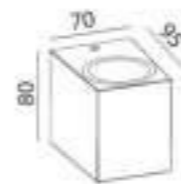

REFERENCE	BULB (No incl)	FINISH
7470	2L x GU10	Corten-Corten
7471	2L x GU10	Corten-Corten
7472	1L x GU10	Corten-Corten
7473	1L x GU10	Corten-Corten
máx. 10W LED (No incl)		100-240V - 50/60Hz Aluminio/Cristal- Aluminium/Glass



Bombillas recomendadas-Suggested bulbs

K	Wat LED	On/Off	Dimmable	Lumens
2700K	7W	R09254	R09257	510lm
3000K	7W	R09255	R09258	540lm
4000K	7W	R09256	R09259	570lm





6610



6611



7037



6614



6615



7038



7039



6613



6612



7040



6617



6616

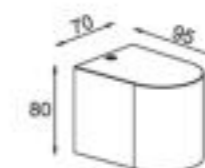

REFERENCE	BULB (No incl)	FINISH
6610	2L x GU10	Gris oscuro-Dark grey
6611	2L x GU10	Blanco-White
7037	2L x GU10	Negro-Black
6614	2L x GU10	Gris oscuro-Dark grey
6615	2L x GU10	Blanco-White
7038	2L x GU10	Negro-Black

máx. 10W LED (No incl) 100-240V-50/60Hz Aluminio/Cristal-Aluminium/Glass



Bombillas recomendadas-Suggested bulbs

K	Wat LED	On/Off	Dimmable	Lumens
2700K	7W	R09254	R09257	510lm
3000K	7W	R09255	R09258	540lm
4000K	7W	R09256	R09259	570lm

REFERENCE	BULB (No incl)	FINISH
6612	1L x GU10	Gris oscuro-Dark grey
6613	1L x GU10	Blanco-White
7039	1L x GU10	Negro-Black
6616	1L x GU10	Gris oscuro-Dark grey
6617	1L x GU10	Blanco-White
7040	1L x GU10	Negro-Black

máx. 10W LED (No incl) 100-240V-50/60Hz Aluminio/Cristal-Aluminium/Glass



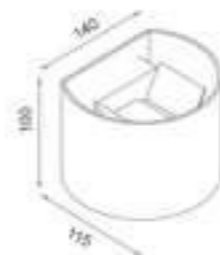
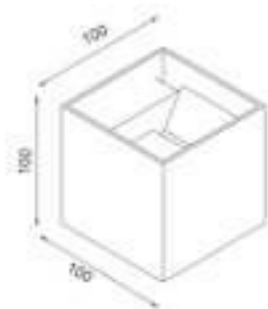

REFERENCE	K	LED WATT	LUMENS	FINISH
6520	3000K	12W	1100lm	Gris oscuro-Dark grey
6521	3000K	12W	1100lm	Bianco arena-Sand white
6524	3000K	12W	1100lm	Negro arena-Sand black
6527	3000K	12W	1100lm	Corten-Corten
6522	3000K	12W	1100lm	Gris oscuro-Dark grey
6523	3000K	12W	1100lm	Bianco arena-Sand white
110-240V - 50/60Hz CRI >80				Aluminio-Aluminium

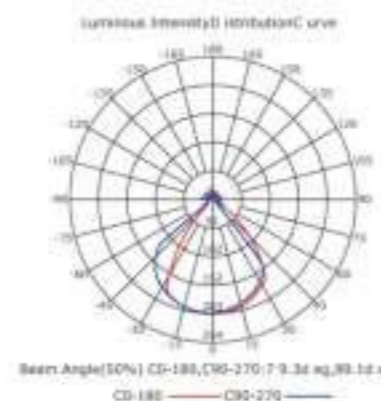
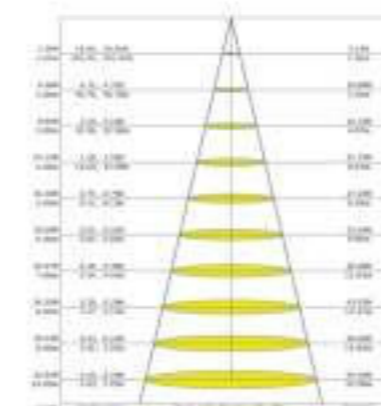
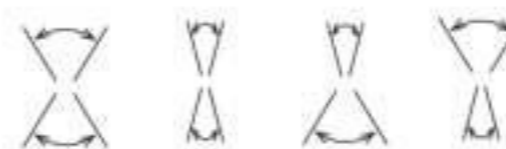

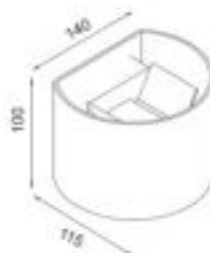
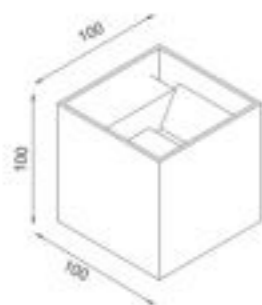
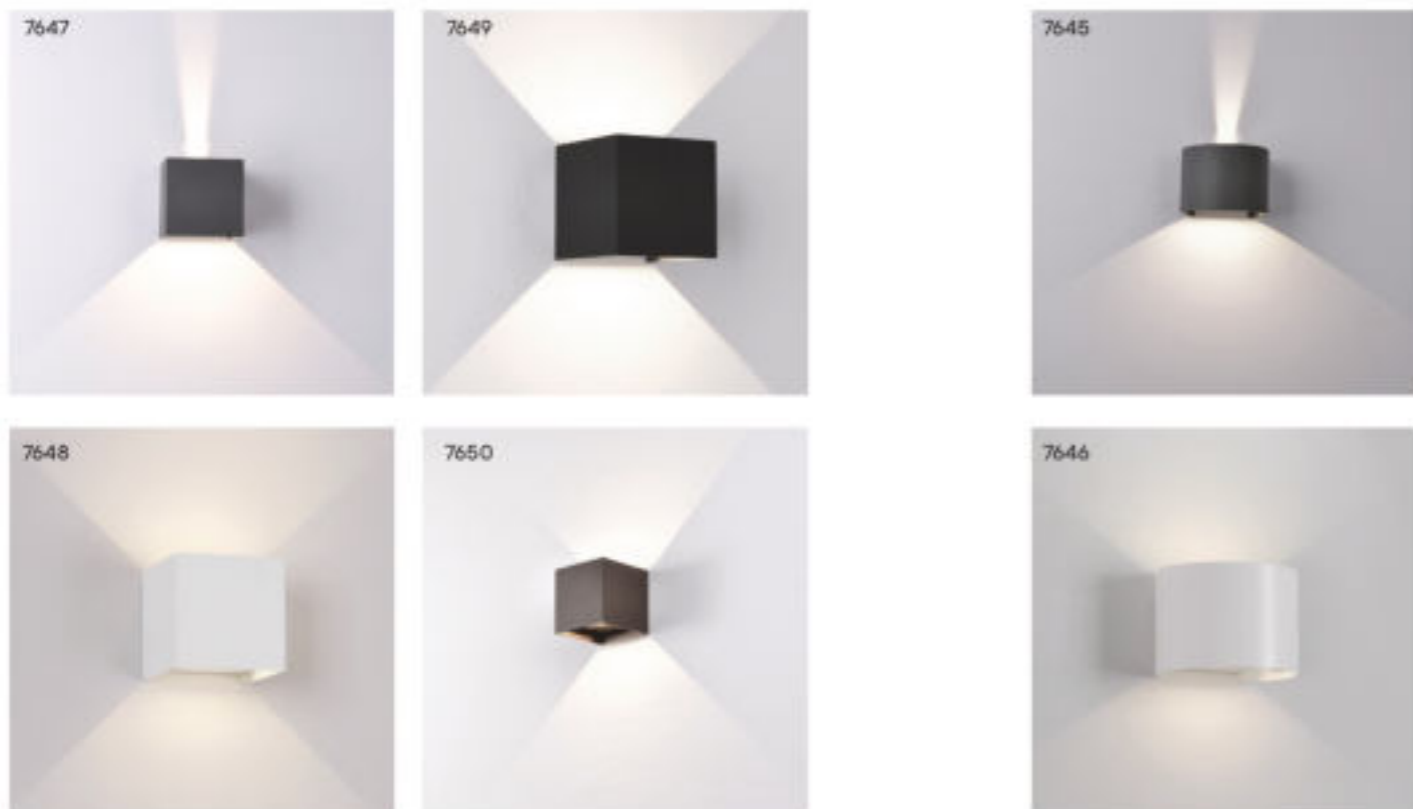

REFERENCE	K	LED WATT	LUMENS	FINISH
7647	4000K	12W	1100lm	Gris oscuro-Dark grey
7648	4000K	12W	1100lm	Blanco arena-Sand white
7649	4000K	12W	1100lm	Negro arena-Sand black
7650	4000K	12W	1100lm	Corten-Corten
7645	4000K	12W	1100lm	Gris oscuro-Dark grey
7646	4000K	12W	1100lm	Blanco arena-Sand white
				Aluminio-Aluminium

220-240V - 50/60Hz CRI >80

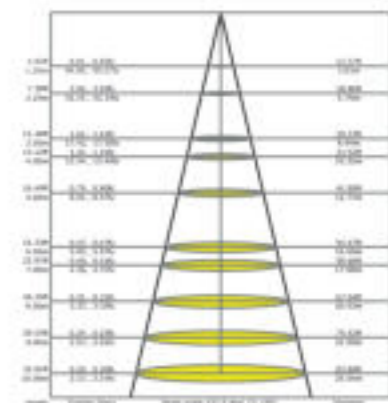
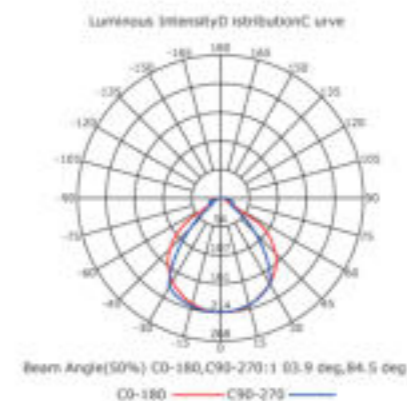
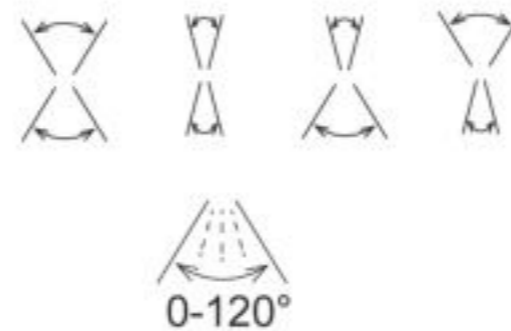



REFERENCE	K	LED WATT	LUMENS	FINISH
7435	3000K	20W	1830lm	Gris oscuro-Dark grey
7436	3000K	20W	1830lm	Blanco arena-Sand white
7437	3000K	20W	1830lm	Negro arena-Sand black
7438	3000K	20W	1830lm	Corten-Corten
7651	4000K	20W	1830lm	Gris oscuro-Dark grey
7652	4000K	20W	1830lm	Blanco arena-Sand white
7653	4000K	20W	1830lm	Negro arena-Sand black
7654	4000K	20W	1830lm	Corten-Corten
220-240V ~ 50/60Hz CRI ≥ 80				Aluminio-Aluminium

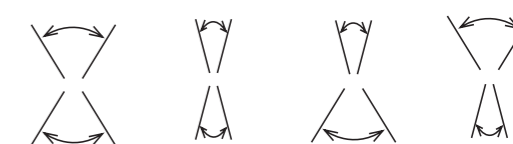
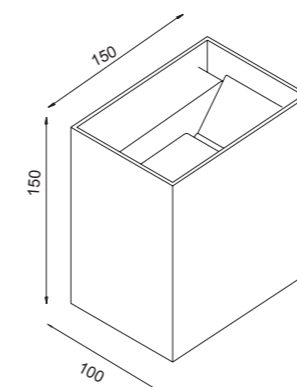

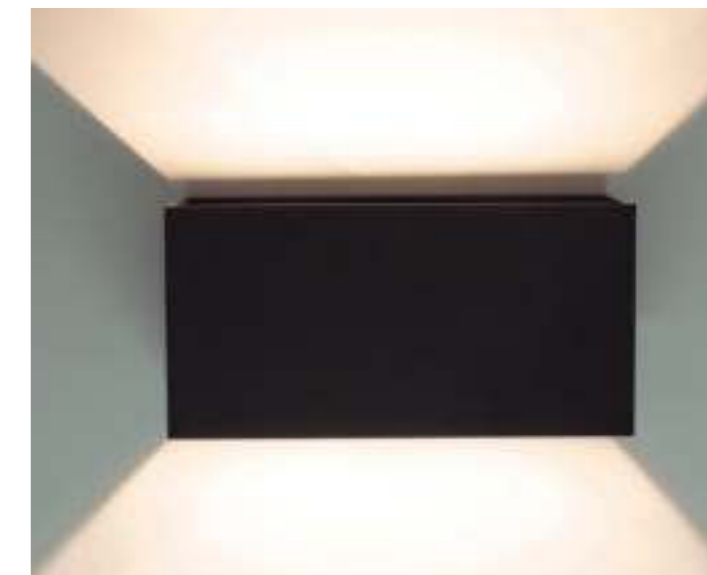
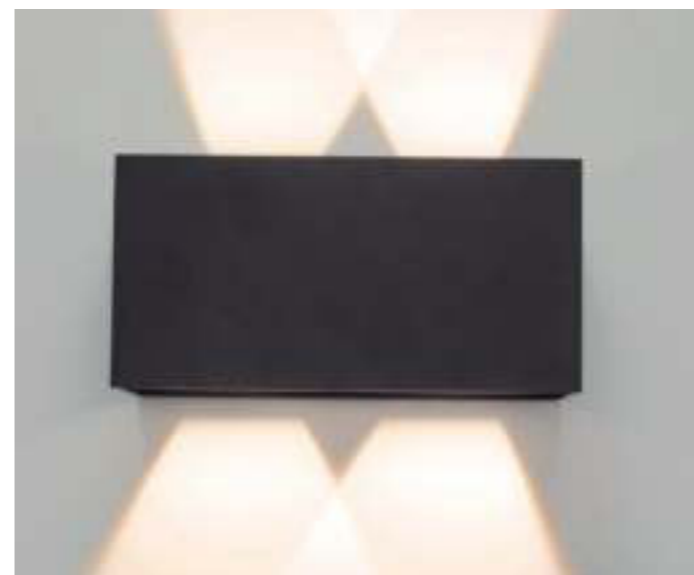
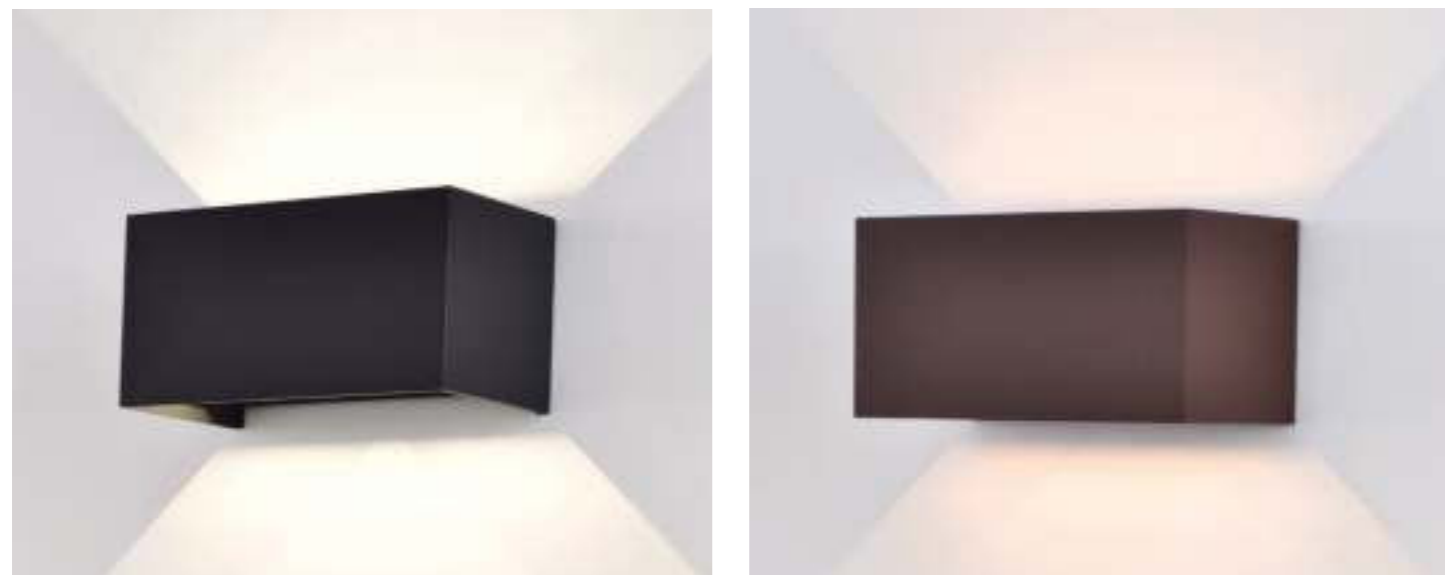

REFERENCE	K	LED WATT	LUMENS	FINISH
New 7815	3000K	4x6W	2200lm	Gris oscuro-Dark grey
New 7816	3000K	4x6W	2200lm	Blanco arena-Sand white
New 7817	3000K	4x6W	2200lm	Negro arena-Sand black
New 7818	3000K	4x6W	2200lm	Corten-Corten
New 7819	4000K	4x6W	2200lm	Gris oscuro-Dark grey
New 7820	4000K	4x6W	2200lm	Blanco arena-Sand white
New 7821	4000K	4x6W	2200lm	Negro arena-Sand black
New 7822	4000K	4x6W	2200lm	Corten-Corten
220-240V~ 50/60Hz				Aluminio-Aluminium

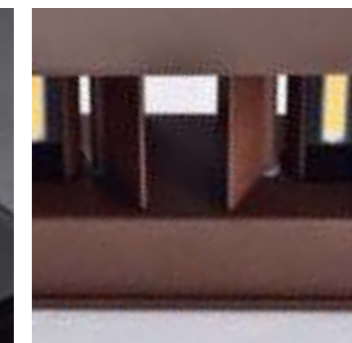
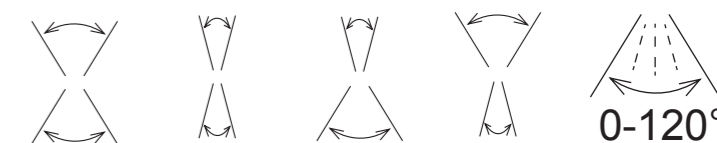
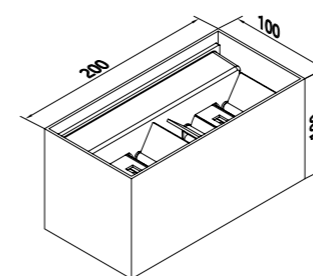

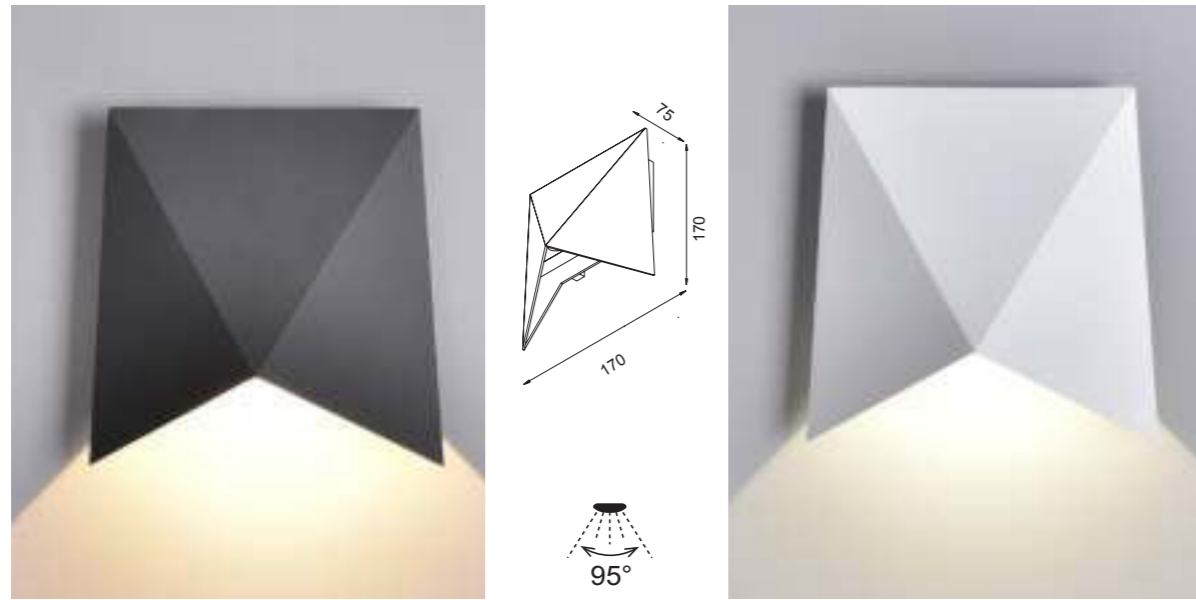

REFERENCE	K	LED WATT	LUMENS	FINISH
6525	3000K	8W	750lm	Gris oscuro-Dark grey
6526	3000K	8W	750lm	Blanco arena-Sand white
220-240V ~ 5 0/60Hz CRI ≥80				Aluminio-Aluminium



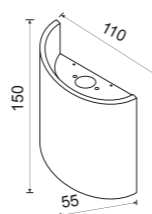
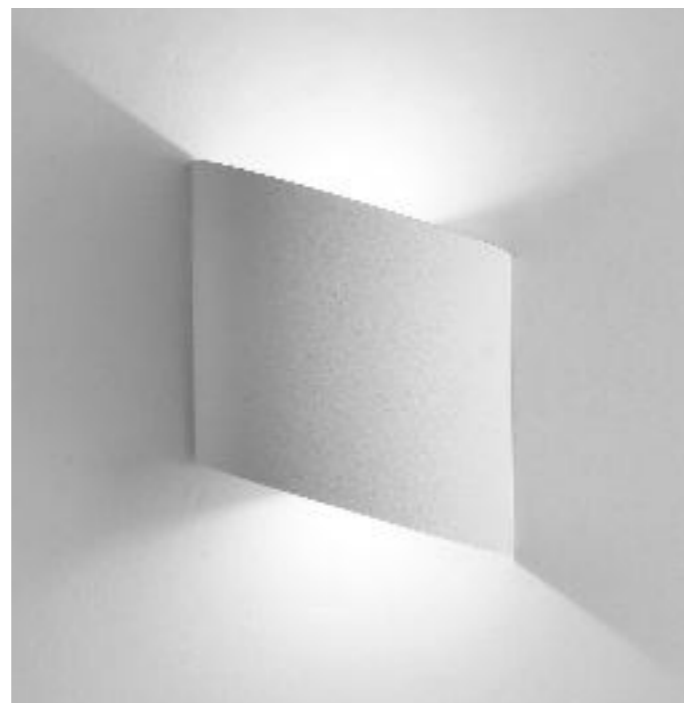
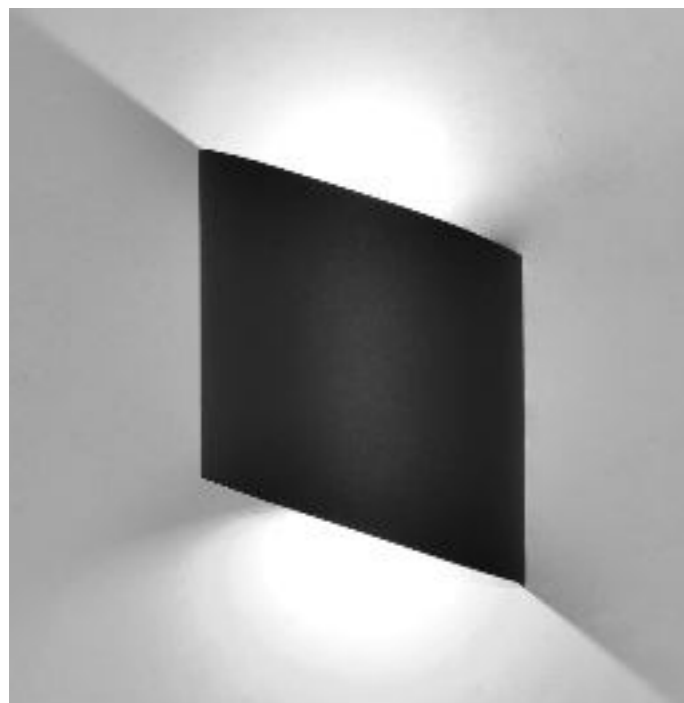

REFERENCE	K	LED WATT	LUMENS	FINISH
6530	3000K	6W	660lm	Gris oscuro-Dark grey
6531	3000K	6W	660lm	Blanco arena-Sand white
220-240V - 5 0/60Hz CRI ≥80				Aluminio-Aluminium

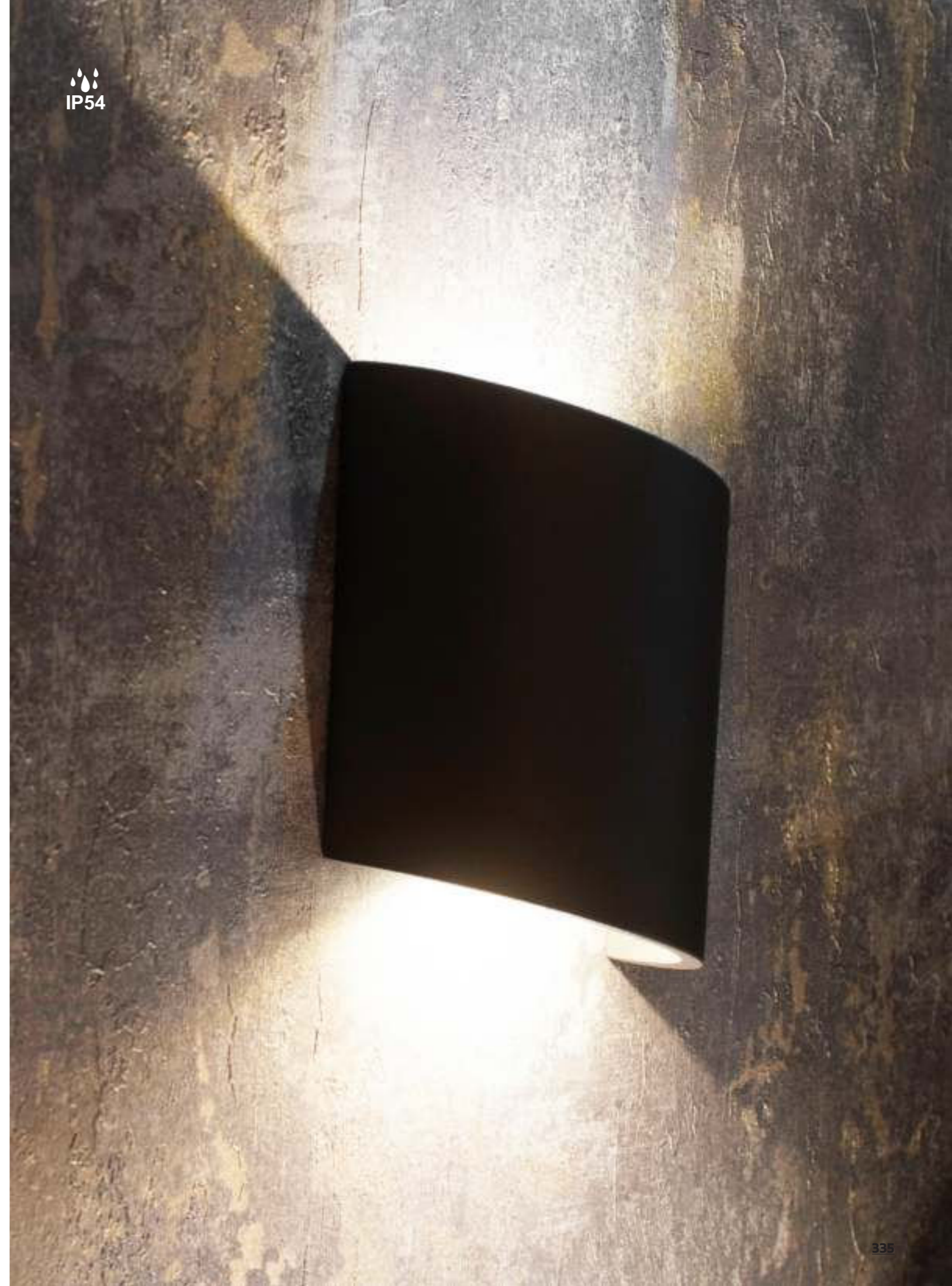



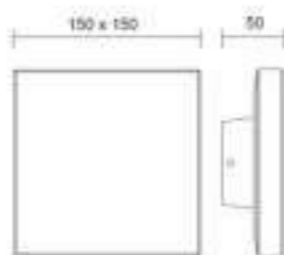
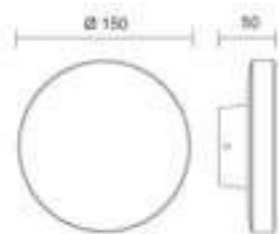

IP54

REFERENCE	K	LED WATT	LUMENS	FINISH	
6534	3000K	9.6W	720lm	Gris oscura-Dark grey	ø 150
6535	3000K	9.6W	720lm	Blanco-White	ø 150
6538	3000K	9.6W	720lm	Corten-Corten	ø 150
6536	3000K	9.6W	720lm	Gris oscura-Dark grey	150 x 150
6537	3000K	9.6W	720lm	Blanco-White	150 x 150
6539	3000K	9.6W	720lm	Corten-Corten	150 x 150
				Aluminio-Aluminium	

220-240V - 50/60Hz





REFERENCE	BULB NO INCLUDED	FINISH
7050	1L • E27	Gris Oscuro-Dark Grey
7051	1L • E27	Blanco-White
7052	1L • E27	Corten-Corten
máx. 20W LED (No incl)		100-240V - 50/60Hz Aluminio-Aluminium



Outdoor



PIR sensor  
A: 120°  
D: ≤6m

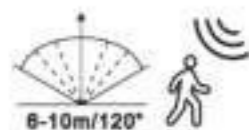
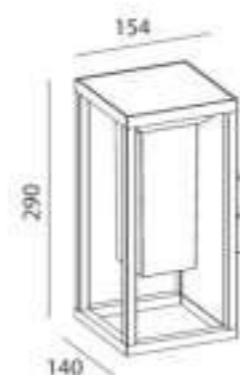

Charge: 6-8h (Sunshine)  
Work time: Full light 3h / Micro light 25h



REFERENCE	K	LED WATT	LUMENS	FINISH
7086	3000K	2,2W	188lm	Grafito-Graphite
			DC 3.7V CRI≥ 80	Aluminio-Aluminium



IP54

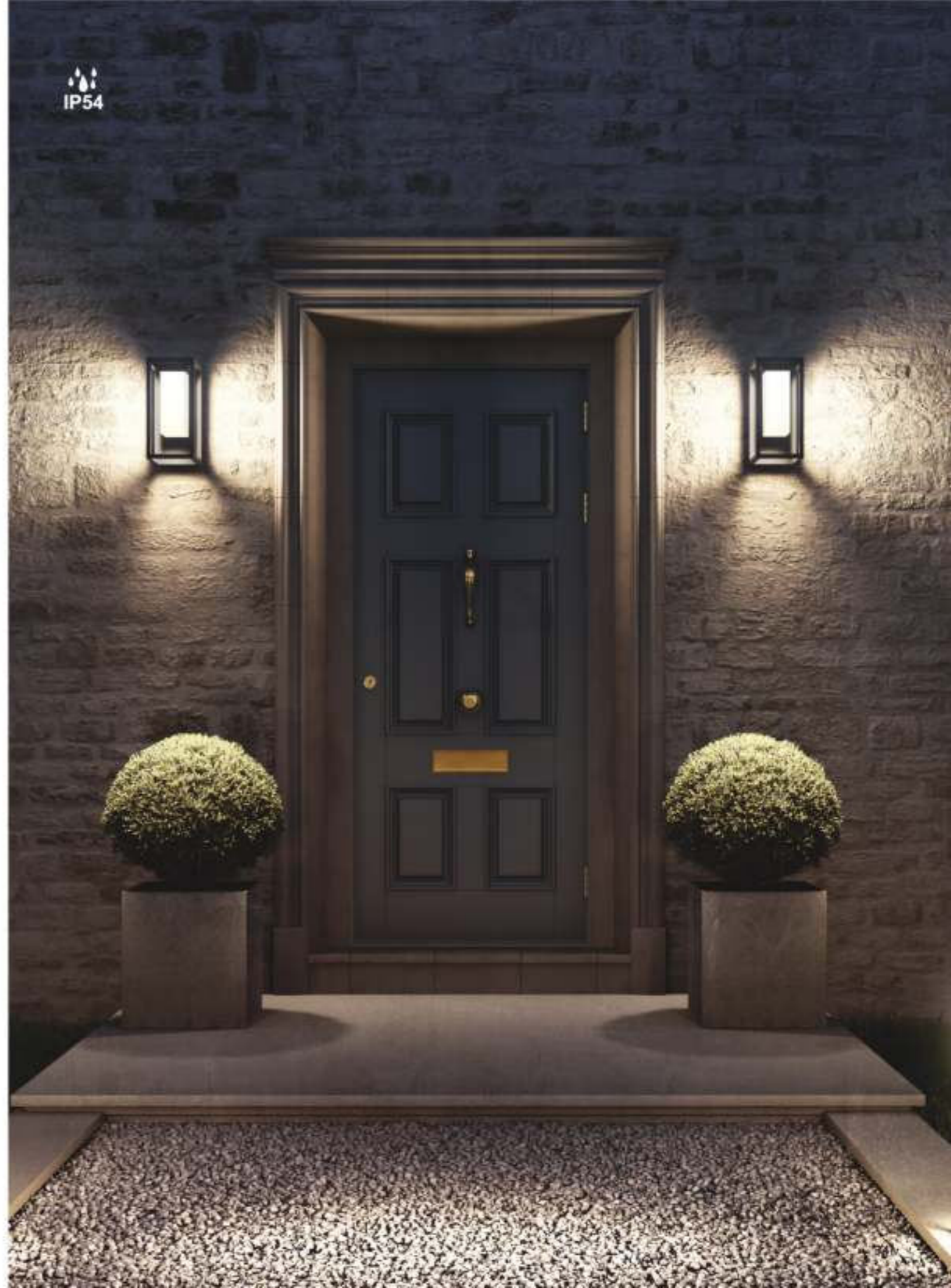



PIR sensor  
A:180°  
D:≤6m

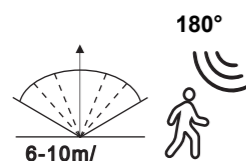

Charge: 6-8h (Sunshine)  
Work time :Full light 3h / Micro light 25h

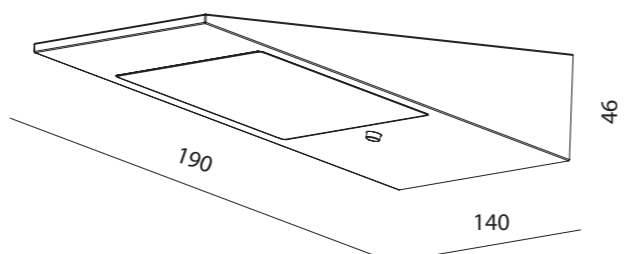

REFERENCE	K	LED WATT	LUMENS	FINISH
7098	3000K	2,2W	188lm	Grafito-Graphite
			DC 3.7V CRI≥ 80	Aluminio-Aluminium



# SOLDEN

Appliques exterior-Outdoor wall lights

Outdoor

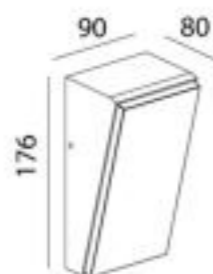

REFERENCE	K	LED WATT	LUMENS	FINISH
7072	3000K	9W	762lm	Gris oscuro-Dark grey
7073	3000K	9W	762lm	Blanco-White
		100-240V - 50/60Hz CRi: 80		Aluminio/PC-Aluminium/PC

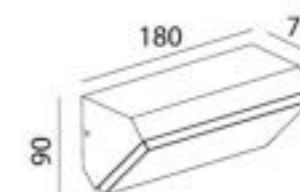

REFERENCE	K	LED WATT	LUMENS	FINISH
7070	3000K	9W	773lm	Gris oscuro-Dark grey
7071	3000K	9W	773lm	Blanco-White
		100-240V - 50/60Hz CRi: 80		Aluminio/PC-Aluminium/PC



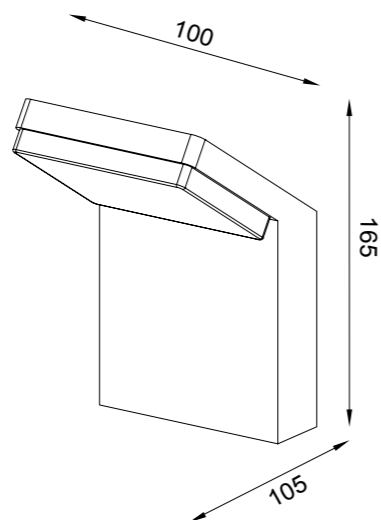

REFERENCE	K	LED WATT	LUMENS	FINISH
7045	3000K	6W	510lm	Gris oscuro-Dark grey
7046	3000K	6W	510lm	Blanco-White
		220-240V~ 50/60Hz CRI≥ 80		Aluminio/PC-Aluminium/PC



8151  
pág. 416

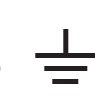
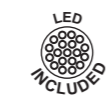

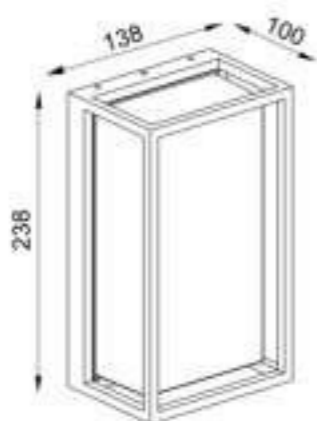

REFERENCE	K	LED WATT	LUMENS	FINISH
7062	3000K	9W	725lm	Gris oscuro-Dark grey
7063	3000K	9W	725lm	Blanco-White
				Aluminio/PC-Aluminium/PC

220-240V - 50/60Hz CRI: 80



7060  
pág. 366



IP65



DRIVER  
TUV

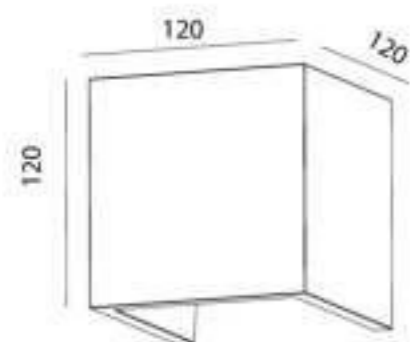

REFERENCE	K	LED WATT	LUMENS	FINISH
7108	3000K	12W	1100lm	Gris Piedra-Stone Grey
7109	3000K	12W	1100lm	Blanco-White
		220-240V - 50/60Hz	Cemento liso-Smooth cement	

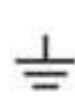

7501  
pág 420



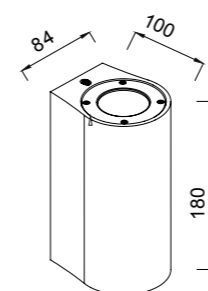
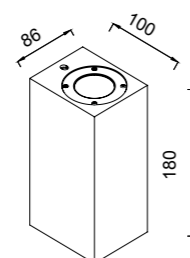

REFERENCE	BULB NO INCLUDED	FINISH
7182	2L x GU10	Blanco-White
7183	2L x GU10	Gris oscuro-Dark grey
	máx. 12W LED (No incl)	100-240V~ 50/60Hz Hormigón-Concrete

REFERENCE	BULB NO INCLUDED	FINISH
7180	2L x GU10	Blanco-White
7181	2L x GU10	Gris oscuro-Dark grey
	máx. 12W LED (No incl)	100-240V~ 50/60Hz Hormigón-Concrete



7187  
pág. 370



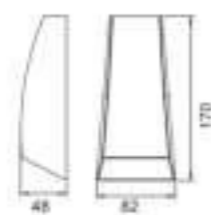

REFERENCE	K	LED WATT	LUMENS	FINISH
6542	3000K	6W	420lm	Gris oscuro-Dark grey
6543	3000K	6W	420lm	Blanco arenado-Sand white
220-240V~ 50/60Hz				Aluminio-Aluminium



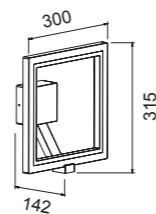

REFERENCE	K	LED WATT	LUMENS	FINISH
6470	3000K	10W	700lm	Gris oscuro-Dark grey
		100-240V ~ 50/60Hz		Aluminio /PC- Aluminium/PC

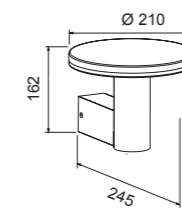

6496

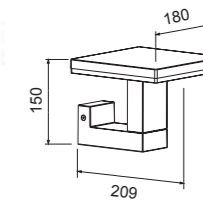

6497

REFERENCE	K	LED WATT	LUMENS	FINISH
6496	3000K	10W	700lm	Gris oscuro-Dark grey
6497	3000K	10W	700lm	Gris oscuro-Dark grey
		100-240V ~ 50/60Hz		Aluminio /PC- Aluminium/PC



6498  
pág. 422

# KANDANCHÚ

Plafón exterior-Outdoor ceiling lamp

Outdoor

Plafón exterior-Ceiling lamp outdoor



REFERENCE	BULB NO INCLUDED	FINISH
New 7900	GU10	Blanco-White
New 7901	GU10	Gris oscuro-Dark grey
New 7902	GU10	Negro-Black
New 7903	GU10	Corten-Corten
1x GU10 máx.10W    100-240V - 50/60Hz    Aluminio/Cristal-Aluminium/Glass		



REFERENCE	BULB NO INCLUDED	FINISH
New 7904	GU10	Blanco-White
New 7905	GU10	Gris oscuro-Dark grey
New 7906	GU10	Negro-Black
New 7907	GU10	Corten-Corten
1x GU10 máx.10W    100-240V - 50/60Hz    Aluminio/Cristal-Aluminium/Glass		



Bombillas recomendadas-Suggested bulbs

K	Wat LED	On/Off	Dimmable	Lumens
2700K	7W	R09254	R09257	510lm
3000K	7W	R09255	R09258	540lm
4000K	7W	R09256	R09259	570lm



# VOLCANO

Plafón exterior-Outdoor ceiling lamp

Outdoor



REFERENCE	BULB NO INCLUDED	FINISH
<b>New</b> 7908	E27	Gris Oscuro-Dark Grey
	1x E27 máx.20W	100-240V - 50/60Hz Aluminio/Cristal-Aluminium/Glass



Bombillas recomendadas-Suggested bulbs

REFERENCE	Wattios LED	CCT	Lumens	Ángulo luz
R09133	10W	3000K	1050lm	320°
R09215	10W	4000K	1080lm	320°
R09134	10W	5000K	1100lm	320°
R09139	14W	3000K	1460lm	240°
R09140	14W	4000K	1510lm	240°





6553

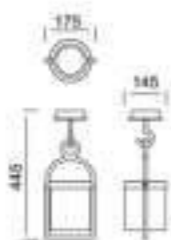

6554

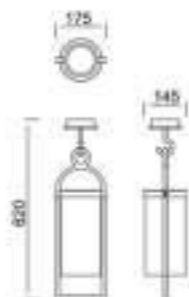

REFERENCE	BULB NO INCLUDED	FINISH
6553	1L • E27	Gris oscuro-Dark grey
6554	1L • E27	Gris oscuro-Dark grey
máx. 20W LED (No incl)		100-240V- 50/60Hz Aluminio/cristal-Aluminum/glass





7065



7066

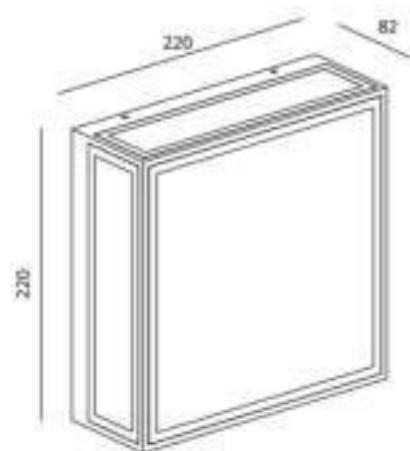

REFERENCE	BULB NO INCLUDED	FINISH
7065	2L • E27	Gris oscuro-Dark grey
7066	2L • E27	Gris oscuro-Dark grey
máx. 20W LED (No incl)		100-240V - 50/60Hz Aluminio/cristal-Aluminium/glass



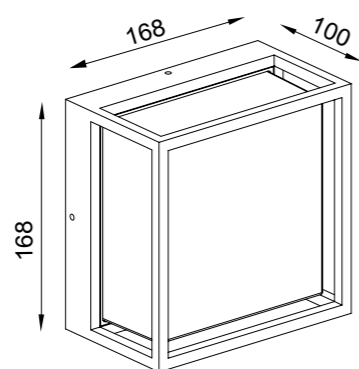

REFERENCE	K	LED WATT	LUMENS	FINISH
7060	3000K	9W	725lm	Gris oscuro-Dark grey
7061	3000K	9W	725lm	Blanco-White
		220-240V~ 50/60Hz	Aluminio/PC-Aluminium/PC	



7062  
pág. 348

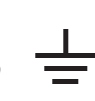



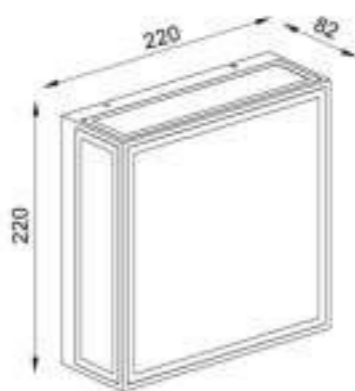

REFERENCE	K	LED WATT	LUMENS	FINISH
7055	3000K	14W	1180lm	Gris oscuro-Dark grey
7056	3000K	14W	1180lm	Blanco-White
		100-240V - 50/60Hz CRI: 80		Aluminio/Cristal-Aluminium/Glass



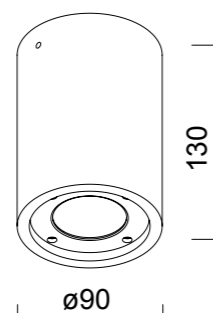

REFERENCE	BULB NO INCLUDED	FINISH
7184	1L x GU10	Blanco-White
7185	1L x GU10	Gris oscuro-Dark grey
máx. 12W LED (No incl)		100-240V~ 50/60Hz Hormigón-Concrete

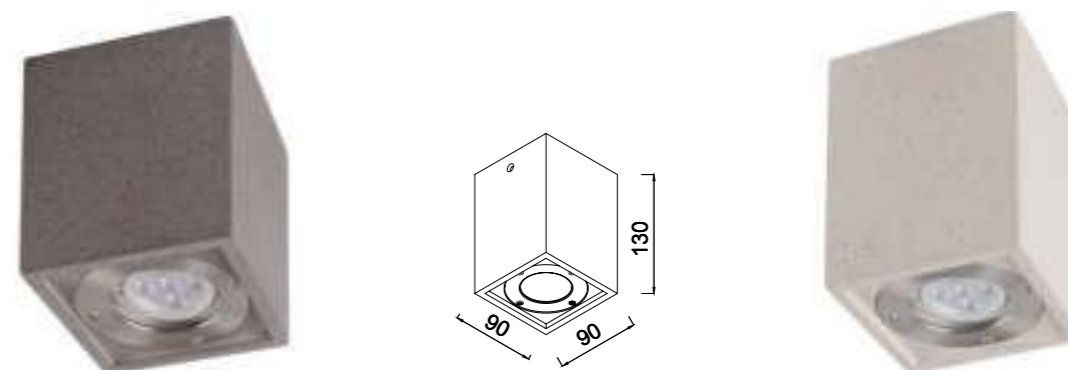

REFERENCE	BULB NO INCLUDED	FINISH
7186	1L x GU10	Blanco-White
7187	1L x GU10	Gris oscuro-Dark grey
máx. 12W LED (No incl)		100-240V~ 50/60Hz Hormigón-Concrete



7181  
pág. 352



# POLINESIA

By Santiago Sevillano

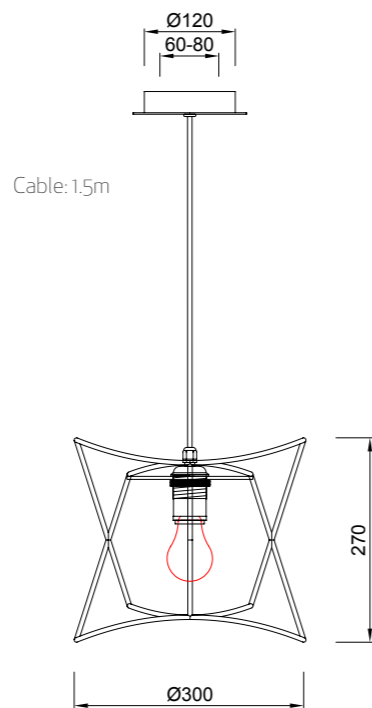
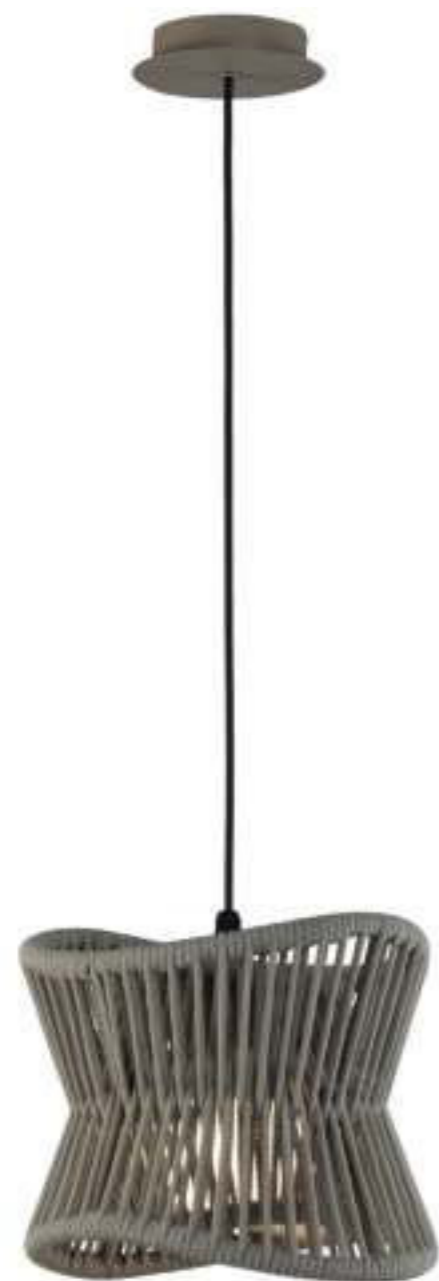

7133  
pág. 302

IP44



REFERENCE	BULB NO INCLUDED	FINISH
7131	1L x E27	Beige oscuro-Dark beige
máx. 20W LED (No incl) 100-240V~ 50/60Hz Aluminio/fibra textil sintética-Aluminium/synthetic textile fibre		



# POLINESIA

By Santiago Sevillano

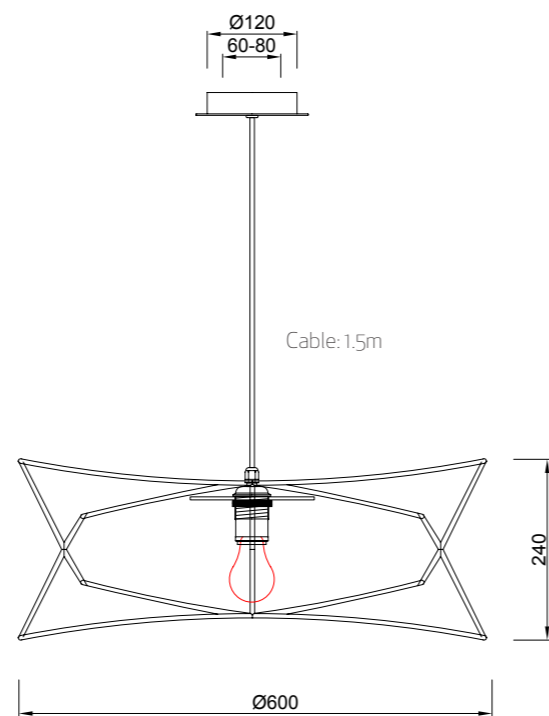

7133  
pág. 302

REFERENCE	BULB NOT INCLUDED	FINISH
7130	1L x E27	Beige oscuro-Dark beige
máx. 20W LED (No incl) 100-240V~ 50/60Hz Aluminio/fibra textil sintética-Aluminium/synthetic textile fibre		



IP44

# KINKÉ

By Santolaria & Lluscà

Colgantes exterior - Outdoor pendant lamp



IP44



REFERENCE	BULB NO INCLUDED	FINISH
6212	1L • E27	Blanco/Grís antracita - White/Gray Anthracite
	max. 20W LED (No incl)	100-240V - 50/60Hz ABS/PE/Aluminium

QAMI (0432141)-023/024/025



**KINKÉ**  
Santolaria & Lluscà

Colgantes exterior - Outdoor pendant lamp



REFERENCE	BULB NO INCLUDED	FINISH
6211	1L • E27	Blanco/Gris antracita - White/Gray Anthracite
	máx. 20W LED (No incl)	100-240V - 50/60Hz ABS/PE/Aluminium

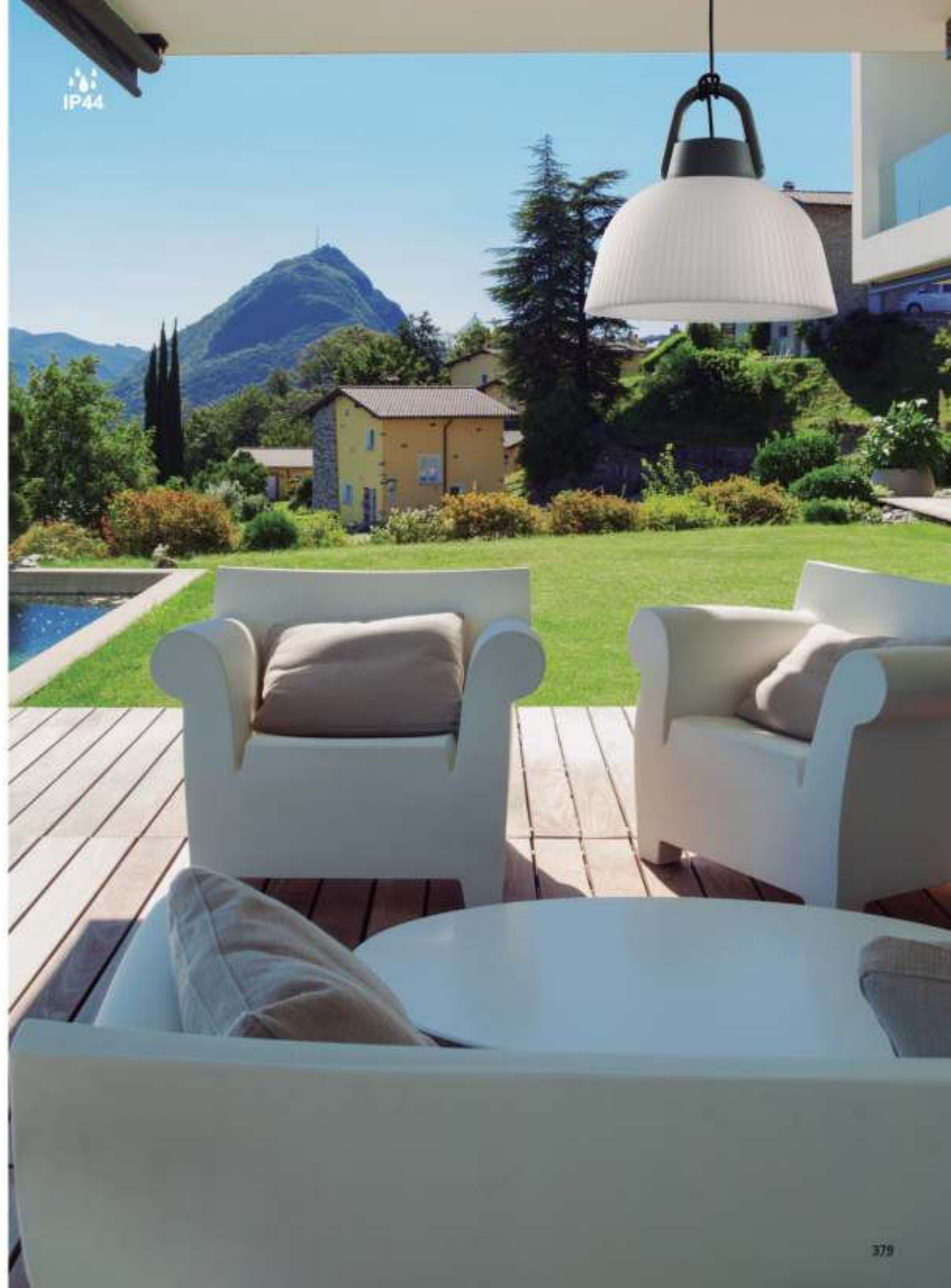

# KINKÉ

Santolaria & Llusçà



REFERENCE	BULB NO INCLUDED	FINISH
6213	1L • E27	Bianco/Gris antracita-White/Gray Anthracite
	máx. 20W LED (No incl)	100-240V- 50/60Hz ABS/PE/Aluminium

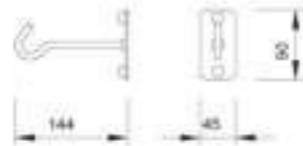

REFERENCE	FINISH
6215	Peana-Base Gris antracita/Gray Anthracite
6214	Gancho-Hook Gris antracita/Gray Anthracite
6218	Peana-Base Acero inoxidable-Base mármol negro Stainless Steel-Black marble base

DAMI 004731413-027/031/025

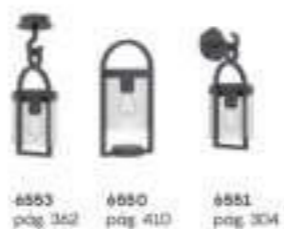

6553  
pág. 3626550  
pág. 4106551  
pág. 304

REFERENCE	BULB NO INCLUDED	FINISH
6555	1L • E27	Gris oscuro - Dark grey
	máx. 20W LED (No incl)	100-240V - 50/60Hz Aluminio/cristal - Aluminium/glass





# AVORIAZ



IP44



REFERENCE	BULB NO INCLUDED	FINISH	
1397	1L x E27	Blanco-White	ø350
1398	1L x E27	Blanco-White	ø400
1399	1L x E27	Blanco-White	ø500
máx. 20W LED (No incl)		PE / ABS / Aluminio-PE / ABS / Aluminium	

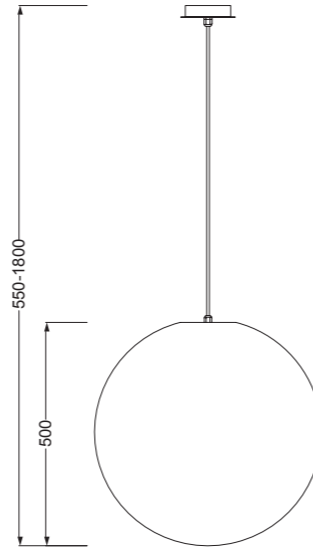
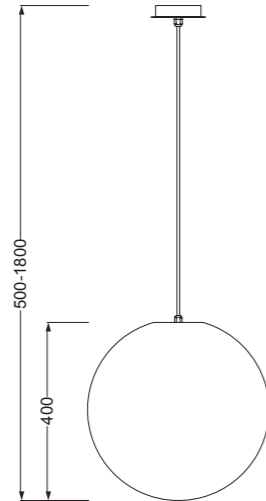
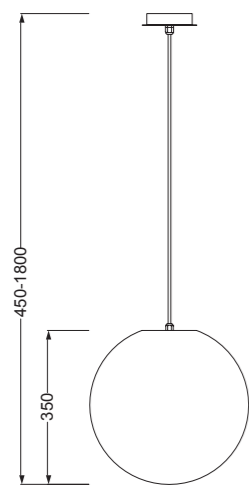

1388  
pág. 428



NOT INCLUDED

IP44



REFERENCE	K	LED WATT	LUMENS	FINISH
<b>Now</b> 7930	3000K	2W	180lm	Blanco-White
<b>Now</b> 7931	3000K	2W	180lm	Negro-Black
<b>Now</b> 7932	3000K	2W	180lm	Corten-Corten
DC 5V / 1A				Aluminio-Aluminium

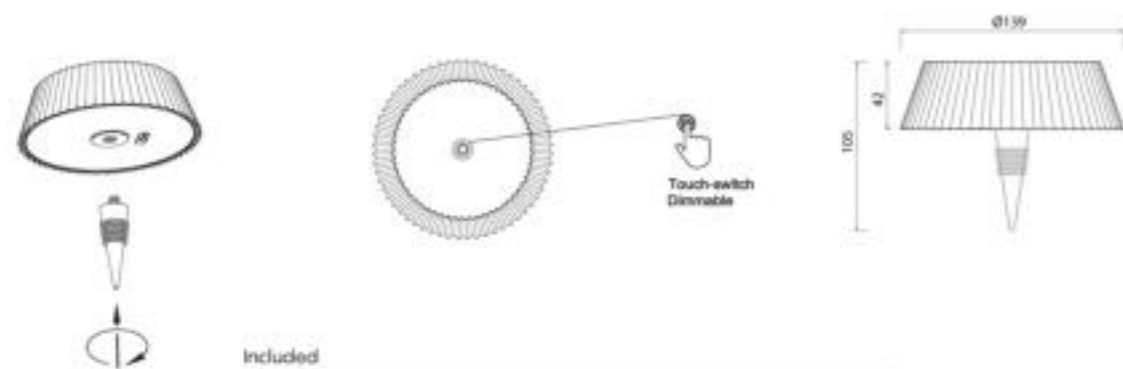

Included





	REFERENCE	K	LED WATT	LUMENS	FINISH
New	7933	3000K	2W	180lm	Blanco-White
New	7934	3000K	2W	180lm	Negro-Black
New	7935	3000K	2W	180lm	Corten-Corten
			DC 5V / 1A	Aluminio-Aluminum	

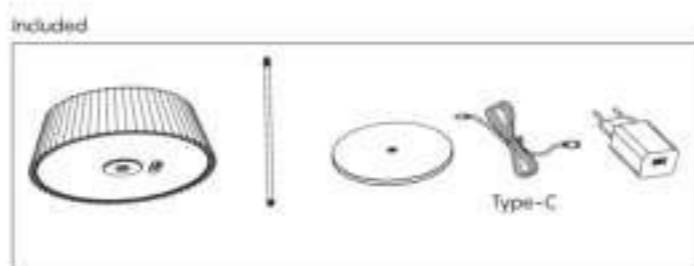
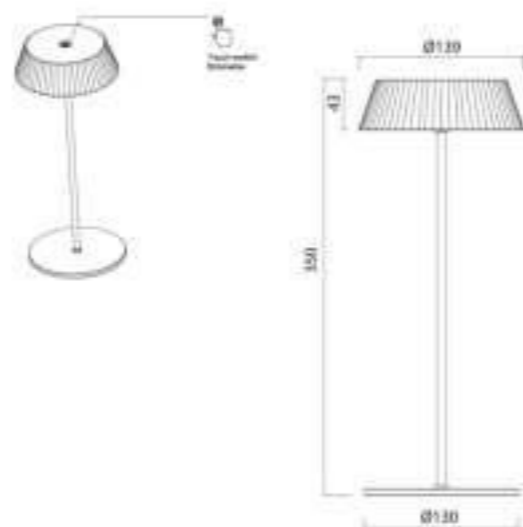



REFERENCE	K	LED WATT	LUMENS	FINISH
7988	3000K	2W	230lm	Blanco-White
7989	3000K	2W	230lm	Negro-Black
		DC 5W1A CRi: 80	Aluminio/PC- Aluminum/PC	





REFERENCE	K	LED WATT	LUMENS	FINISH
7985	3000K	2W	180lm	Blanco-White
7986	3000K	2W	180lm	Negro-Black
7987	3000K	2W	180lm	Corten-Corten
DC 5V/1A CRI≥ 80				Aluminio-Aluminum





REFERENCE	K	LED WATT	LUMENS	FINISH
7116	3000K	2W	155lm	Blanco-White
7115	3000K	2W	155lm	Negro-Black
		DC 5V1A CRt: 85	Aluminio/PC- Aluminum/PC	



IP54





REFERENCE	K	LED WATT	LUMENS	FINISH
6480	3000K	2.2W	188lm	Negro mate-Matt black
6484	3000K	2.2W	188lm	Amarillo-Yellow
6481	3000K	2.2W	188lm	Blanco mate-Matt white
		DC 5W1A CRI: 85	Aluminio/PC-Aluminium/PC	





REFERENCE	K	LED WATT	LUMENS	FINISH
7100	3000K	2.2W	188lm	Blanco mate-Matt white
7101	3000K	2.2W	188lm	Negro mate-Matt black
		DC 3.7V	CRI: 80	Aluminio/PC-Aluminum/PC



6480  
pág. 396





Outdoor



IP54



REFERENCE	K	LED WATT	LUMENS	FINISH	SIZES
7090	3000K	3W	238lm	Grafita-Graphite	290•175mm
7091	3000K	3W	238lm	Blanca-White	290•175mm
7092	3000K	3W	238lm	Grafita-Graphite	360•175mm
7093	3000K	3W	238lm	Blanca-White	360•175mm
DC 3.7V CRI: 80				Aluminio-Aluminum	



Charge: 16-17H (sunshine)  
6-7H (usb charging)





REFERENCE	K	LED WATT	LUMENS	FINISH	SIZES
6491	3000K	2,2W	188lm	Grafita-Graphite	470mm
6905	3000K	2,2W	188lm	Bianco-White	470mm
6907	3000K	2,2W	188lm	Grafita-Graphite	670mm
6906	3000K	2,2W	188lm	Bianco-White	670mm
				Aluminio-Aluminum	

DC 5W1A CRI: 80



IP54

# FLAME

by Santiago Sevillano Studio

Lámpara de suelo-Floor lamp

Outdoor



REFERENCE	BULB NO INCLUDED	FINISH
1326	1L • E27	Blanco-White
	máx. 20W LED (No incl)	100-240V- 50/60Hz PE/ABS-PE/ABS

### Complementos Exterior-Outdoor Complements

Piqueta-Spike 210 mm	Piqueta-Spike 160 mm	Base-Ground base ø50
TU0652	TU0492	TU0494



1400  
pág. 432



IP65

FLAME



Outdoor



IP54

PIR sensor  
A: 120°  
D: ≤6m

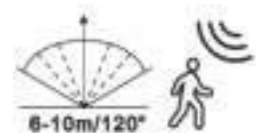

Charge: 6-8h (Sunshine)  
Work time: Full light 3h / Micro light 25h

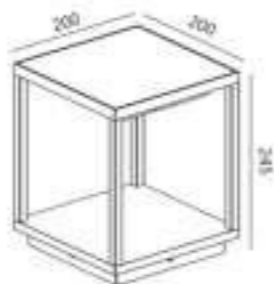

7085 pág 340  
6495 pág 304

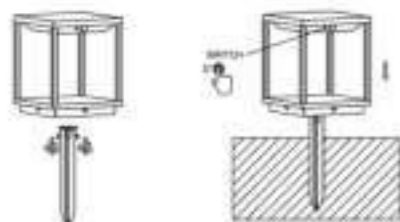

Included

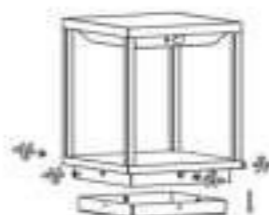

Included

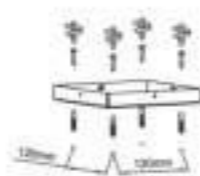

REFERENCE	K	LED WATT	LUMENS	FINISH
7085	3000K	3,5W	300lm	Grafito-Graphite
		DC 3,7V	CRi > 80	Aluminio-Aluminum





REFERENCE	BULB NO INCLUDED	FINISH
6490	1L x E27	Grafito-Graphite
	máx. 20W LED (No incl)	100-240V~ 50/60Hz Aluminio/cristal-Aluminium/glass



6492  
pág. 308



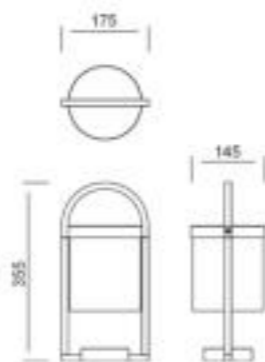

REFERENCE	BULB NO INCLUDED	FINISH
6550	1L • E27	Grts oscuro-Dark grey
	máx. 20W LED (No incl)	100-240V - 50/60Hz Aluminio/cristal-Aluminium/glass





REFERENCE	K	LED WATT	LUMENS	FINISH	HEIGHT
6771	3000K	13W	980lm	Gris Oscuro/Madera-Dark Grey/Wood	350
6772	3000K	13W	980lm	Gris Oscuro/Madera-Dark Grey/Wood	600
6773	3000K	13W	980lm	Gris Oscuro/Madera-Dark Grey/Wood	1000
				Aluminio/PC-Aluminium/PC	

100-240V~ 50/60Hz CRI:≥ 80



6770  
pág. 306





IP54

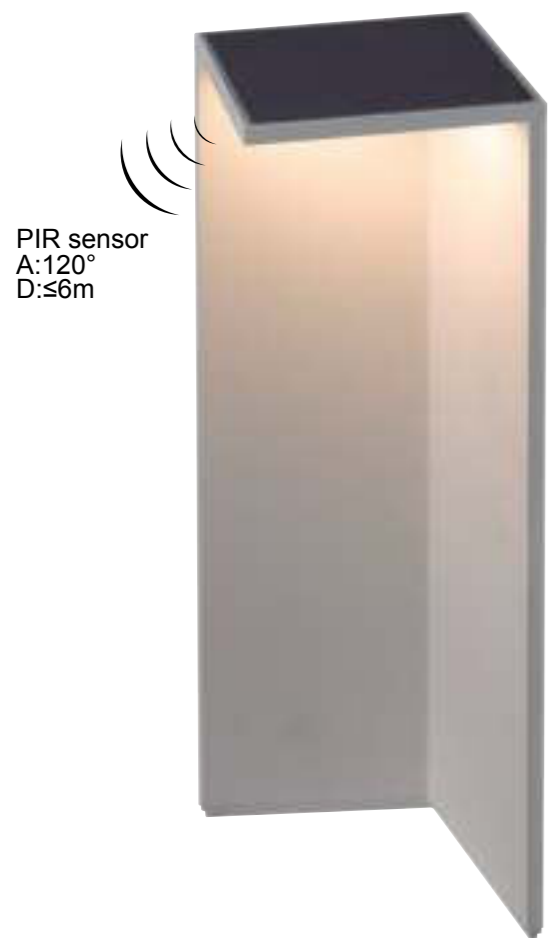

Charge: 6-8h (Sunshine)  
Work time : Full light 3h / Micro light 25h

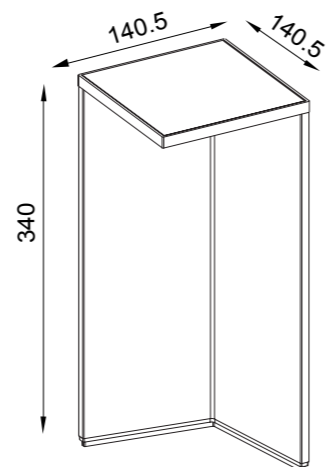
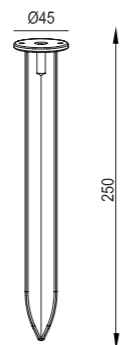
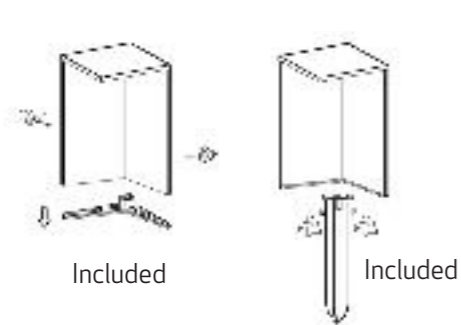

REFERENCE	K	LED WATT	LUMENS	FINISH
7088	3000K	2,2W	188lm	Grafito-Graphite
		DC 3.7V CRI≥ 80		Aluminio-Aluminium







7048  
pág. 346

REFERENCE	K	LED WATT	LUMENS	FINISH
8151	3000K	12W	1020lm	Gris oscuro-Dark grey
		220-240V- 50/60Hz	CRt± 80	Aluminio/PC-Aluminium/PC

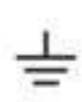



REFERENCE	BULB NO INCLUDED	FINISH
8108	1L • E27	Gris Oscuro-Dark grey
8109	1L • E27	Gris Oscuro-Dark grey
máx. 20W LED (No incl)		100-240V- 50/60Hz Aluminium/PC-Aluminium/PC

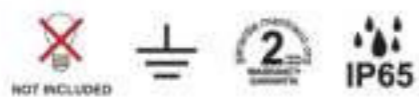



REFERENCE	K	LED WATT	LUMENS	FINISH
7105	3000K	6.5W	490lm	Gris Piedra-Stone grey
7106	3000K	12W	905lm	Gris Piedra-Stone grey
220-240V- 50/60Hz CRI≥ 80				Cemento liso-Smooth cement

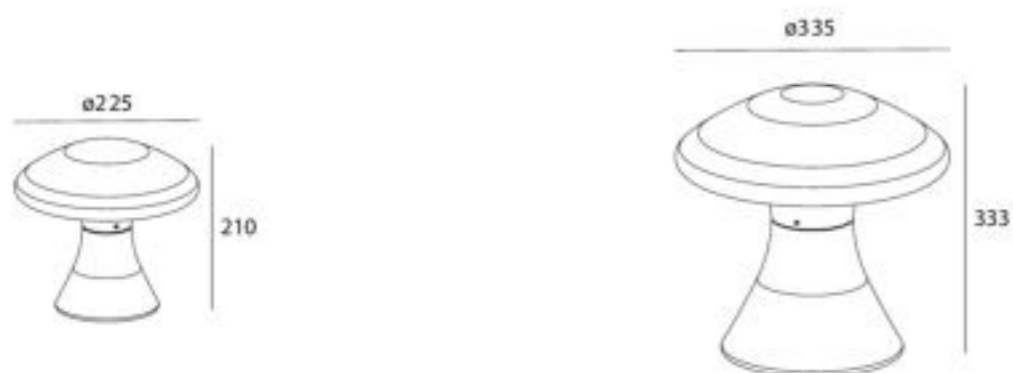

7106  
pág. 350

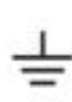



REFERENCE	K	LED WATT	LUMENS	FINISH	SIZES
6498	3000K	10W	700lm	Gris oscuro-Dark grey	600
6499	3000K	10W	700lm	Gris oscuro-Dark grey	1000
				100-240V - 50/60Hz CRI≥ 80	Aluminio /PC - Aluminium/PC



6497  
pág 357





REFERENCE	BULB NO INCLUDED	FINISH
8155	IL • GU10	Negro-Black
	máx. 12W LED (No incl)	100-240V - 50/60Hz Aluminio-Aluminium



Bombillas recomendadas-Suggested bulbs

K	Wat LED	On/Off	Phase cut	Lumens
2700K	7W	R09254	R09257	510lm
3000K	7W	R09255	R09258	540lm
4000K	7W	R09256	R09259	570lm





7108  
pág. 360

REFERENCE	BULB NO INCLUDED	FINISH
7107	1L + GU10	Gris Piedra- Stone Grey
	máx. 12W LED (No incl)	100-240V - 50/60Hz Cemento liso-Smooth cement



Bombillas recomendadas-Suggested bulbs

K	Wat LED	On/Off	Phase cut	Lumens
2700K	7W	R09254	R09257	510lm
3000K	7W	R09255	R09258	540lm
4000K	7W	R09256	R09259	570lm

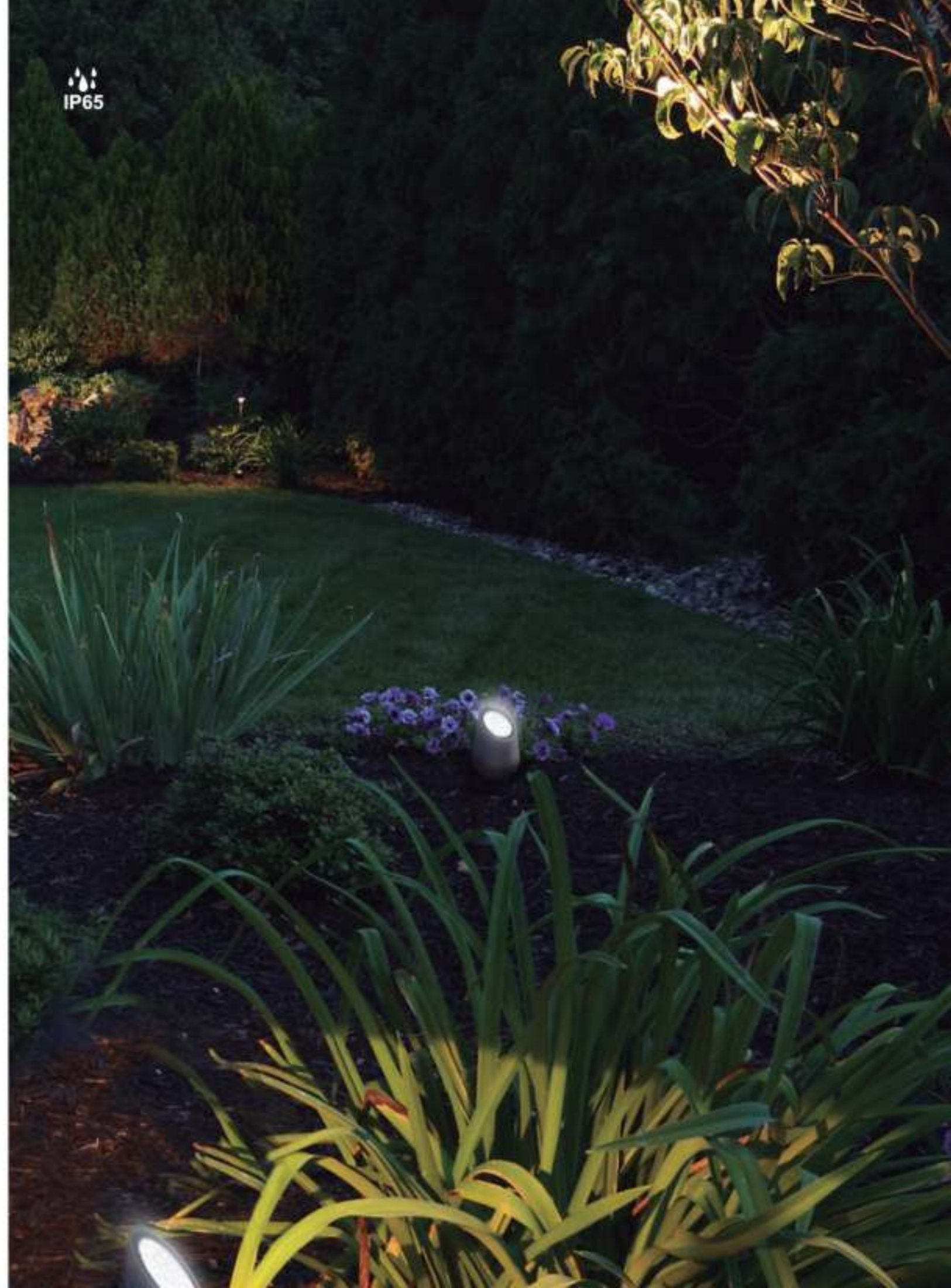



IP65



REFERENCE	BULB NO INCLUDED	FINISH	
1388	1L • E27	Blanco-White	ø350
1391	1L • E27	Blanco-White	ø400
1394	1L • E27	Blanco-White	ø500
máx. 20W LED (No incl)		100-240V - 50/60Hz PE/ABS-PE/ABS	

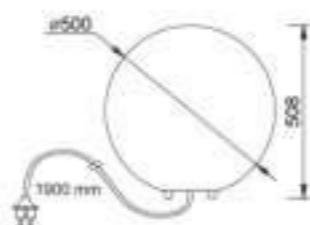
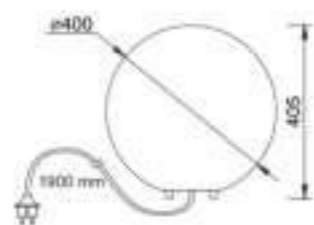
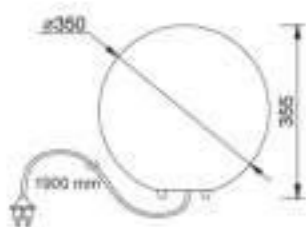

Complementos exterior \*NO INCLUIDO-Outdoor complements \*NOT INCLUDED

TU0492	TU0652	TU0653	TU0494



1397  
pág. 384



# ESPIGA

by Santolaria & Lluscà

Lámpara de suelo-Floor lamp

Outdoor



REFERENCE	BULB NO INCLUDED	FINISH
6545	2L • G9	Gris oscuro-Dark Grey
6546	3L • G9	Gris oscuro-Dark Grey
6547	5L • G9	Gris oscuro-Dark Grey
máx. 5W LED (No incl)		100-240V- 50/60Hz Aluminio-Aluminium

Complementos exterior \*NO INCLUIDO-Outdoor complements \*NOT INCLUDED

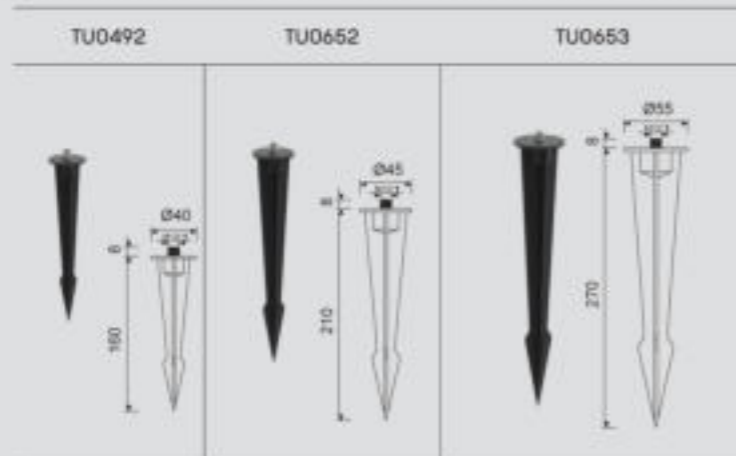

OAMI 005818614-0001



# FLAME

by Santiago Sevillano Studio

Lámpara de suelo - Floor lamp

Outdoor

IP65

OAMI 01793845-0001



REFERENCE	BULB NO INCLUDED	FINISH
1400	4L • GU10 máx 12W LED (No incl) 3L • E27 máx 20W LED (No incl)	Blanco-White
	100-240V - 50/60Hz	PE/Acero-PE/Steel



### Bombillas recomendadas - Suggested bulbs

BULB	Reference	Reference
GU10	R09219	R09220
E27	R09139	R09140

### Complementos exterior \*NO INCLUIDO - Outdoor complements \*NOT INCLUDED

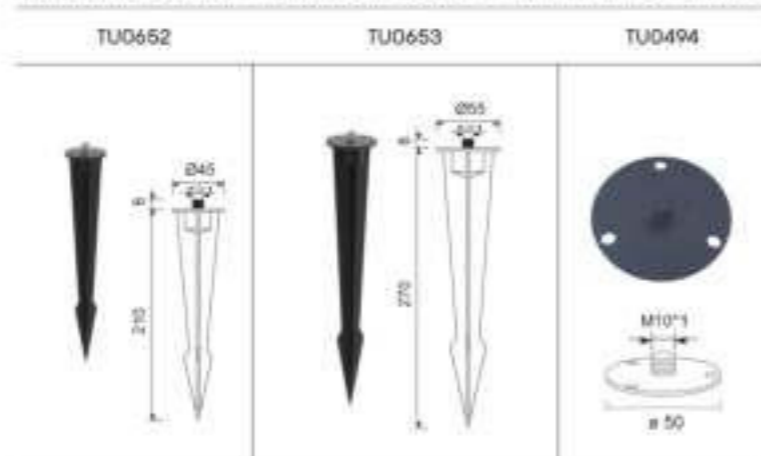



REFERENCE	K	LED WATT	LUMENS	FINISH
7011	3000K	3W	210lm	Gris Oscuro-Dark Grey
7012	3000K	3W	210lm	Blanco arena-Sand white
7640	3000K	3W	210lm	Corten-Corten
7015	3000K	6W	420lm	Gris Oscuro-Dark Grey
7016	3000K	6W	420lm	Blanco arena-Sand white
7642	3000K	6W	420lm	Corten-Corten
220-240V - 50/60Hz CRI ≥ 80				Aluminio/PC-Aluminium/PC



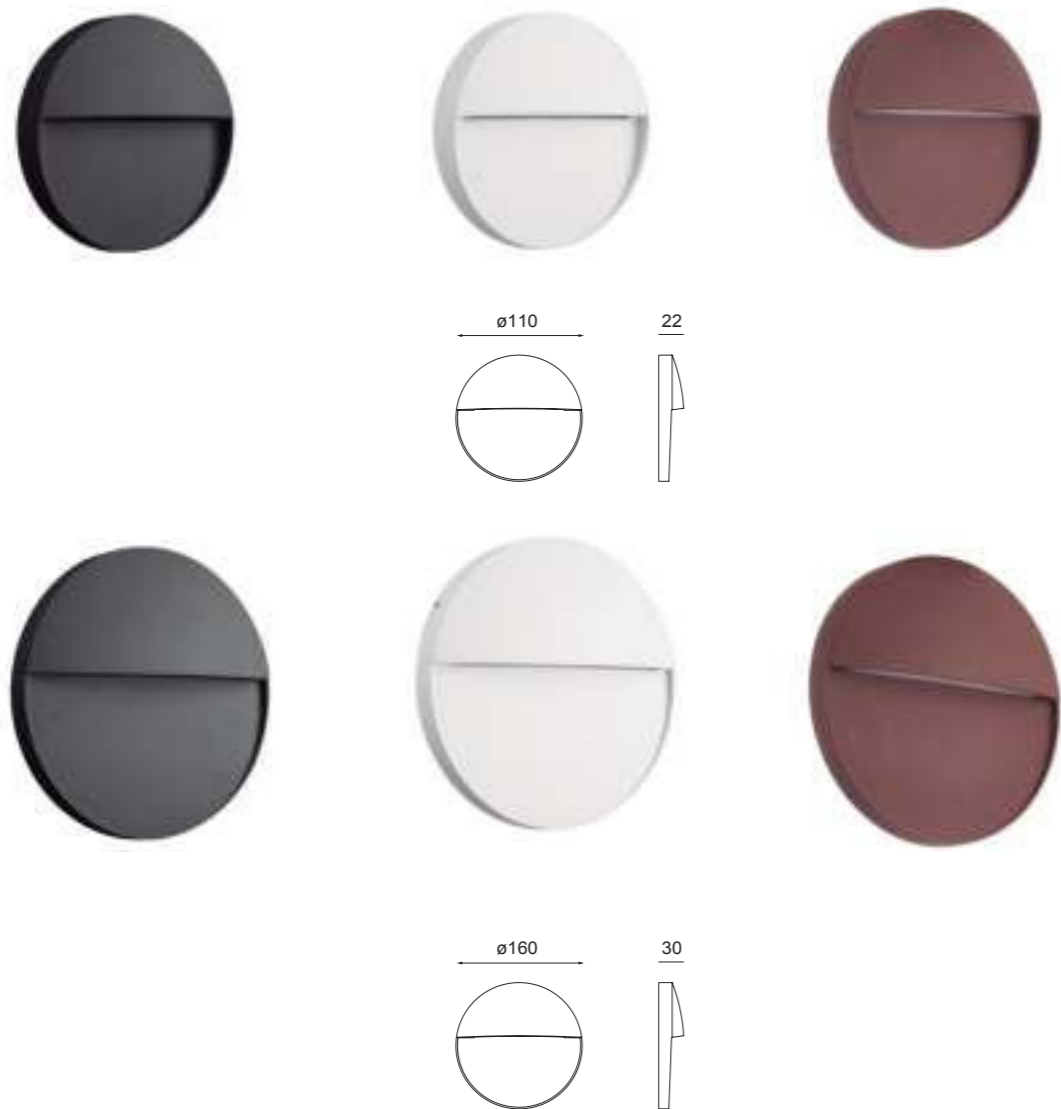

REFERENCE	K	LED WATT	LUMENS	FINISH
7013	3000K	3W	210lm	Gris Oscuro-Dark Grey
7014	3000K	3W	210lm	Blanco arena-Sand white
7641	3000K	3W	210lm	Corten-Corten
7017	3000K	6W	420lm	Gris Oscuro-Dark Grey
7018	3000K	6W	420lm	Blanco arena-Sand white
7643	3000K	6W	420lm	Corten-Corten
220-240V~ 50/60Hz CRI:≥ 80				Aluminio/PC-Aluminium/PC

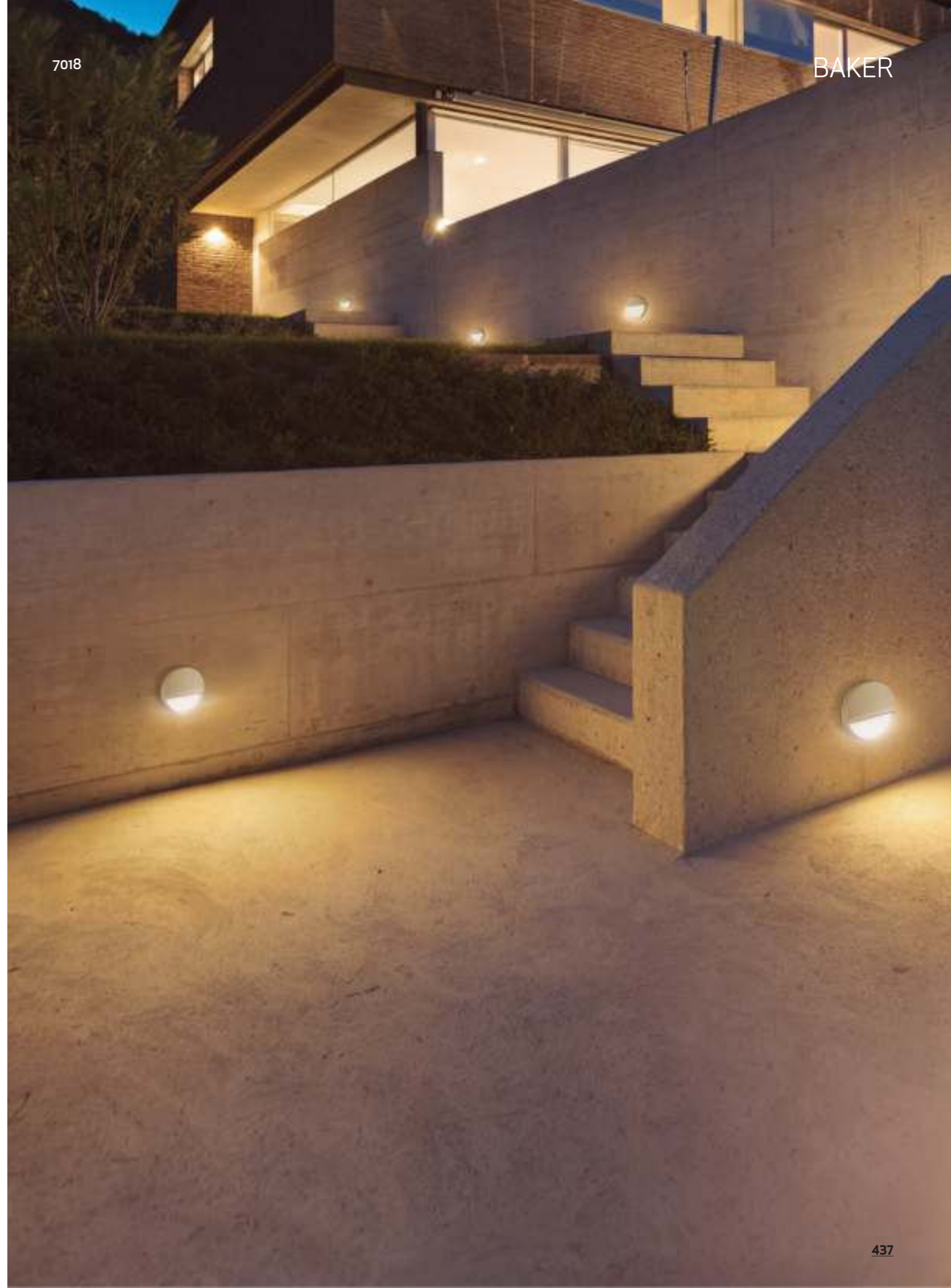

# ASPEN

Señalizadores empotrables-Recessed step wall lights

Outdoor

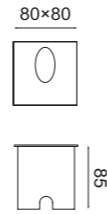
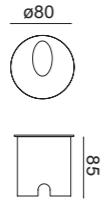

REFERENCE	K	LED WATT	LUMENS	FINISH	HEIGHT
7021	3000K	3W	210lm	Gris Oscuro-Dark Grey	ø80
7022	3000K	3W	210lm	Negro arena-Sand black	ø80
7023	3000K	3W	210lm	Blanco arena-Sand white	ø80
7024	3000K	3W	210lm	Gris Oscuro-Dark Grey	80 x 80
7025	3000K	3W	210lm	Negro arena-Sand black	80 x 80
7026	3000K	3W	210lm	Blanco arena-Sand white	80 x 80
				Aluminio/PC-Aluminium/PC	

200-240V~ 50/60Hz CRI:≥ 80

LUMINOUS INTENSITY DISTRIBUTION DIAGRAM

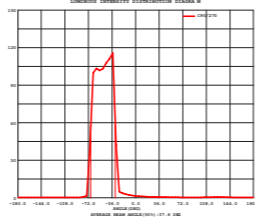
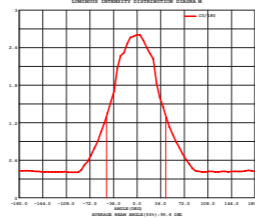
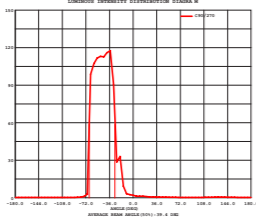
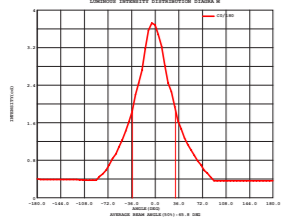
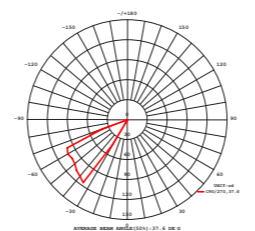
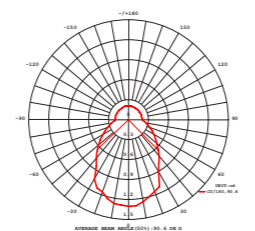
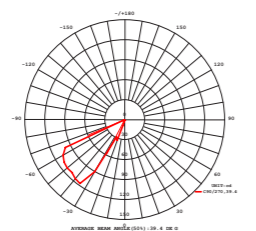
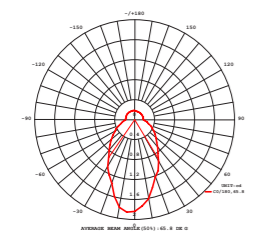

× Modos Instalación-Installation Forms



Con tubo carcasa-Recessed tube housing



76mm



Con pinzas-With clamps



74mm

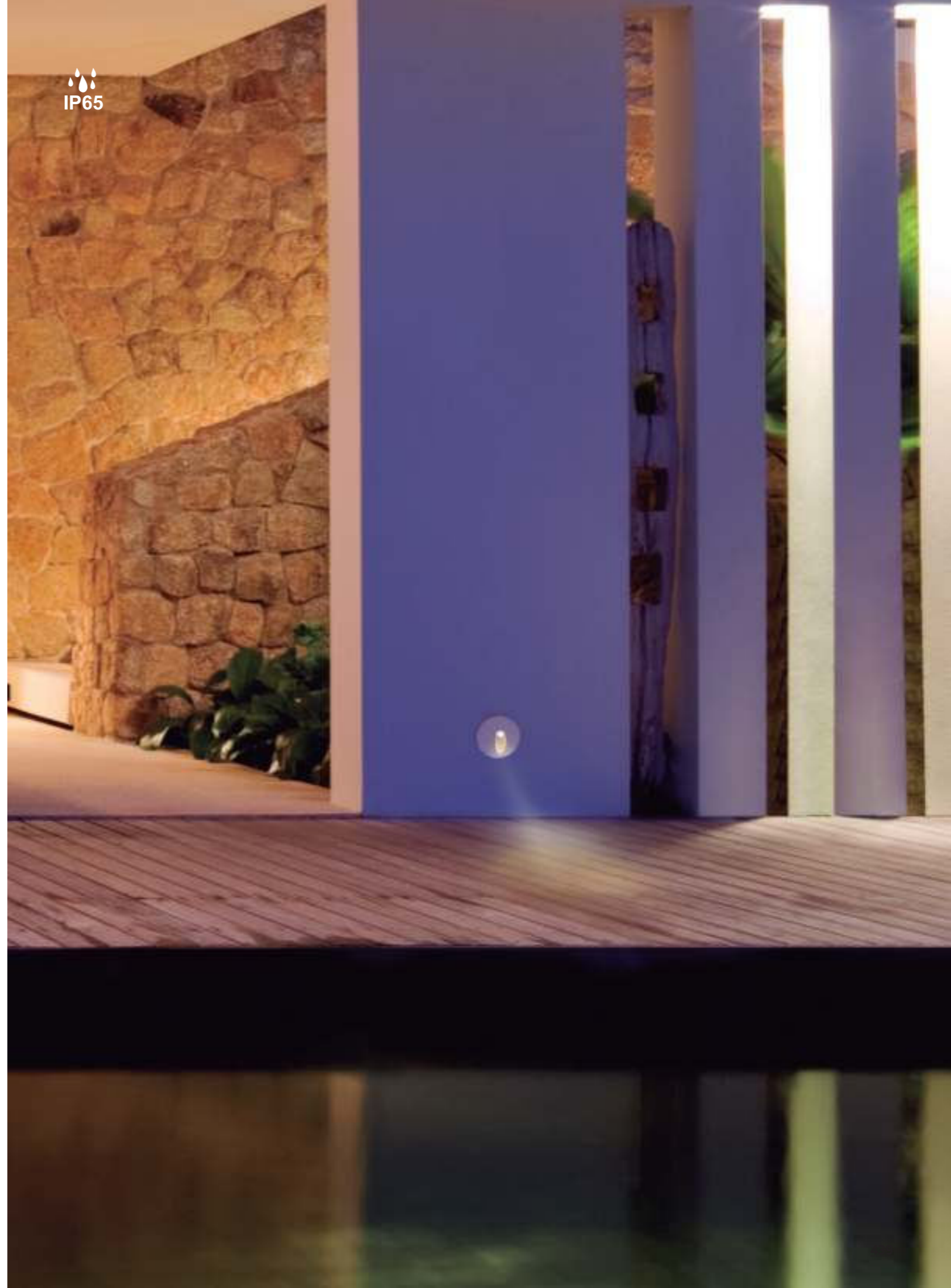

IP65

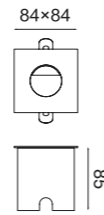
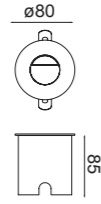

REFERENCE	K	LED WATT	LUMENS	FINISH	HEIGHT
7027	3000K	3W	210lm	Gris Oscuro-DarkGrey	ø80
7028	3000K	3W	210lm	Negro arena-Sand black	ø80
7029	3000K	3W	210lm	Blanco arena-Sand white	ø80
7030	3000K	3W	210lm	Gris Oscuro-DarkGrey	80 × 80
7031	3000K	3W	210lm	Negro arena-Sand black	80 × 80
7032	3000K	3W	210lm	Blanco arena-Sand white	80 × 80
				Aluminio/PC-Aluminium/PC	

200-240V~ 50/60Hz CRI:≥ 80

LUMINOUS INTENSITY DISTRIBUTION DIAGRAM

LUMINOUS INTENSITY DISTRIBUTION DIAGRAM

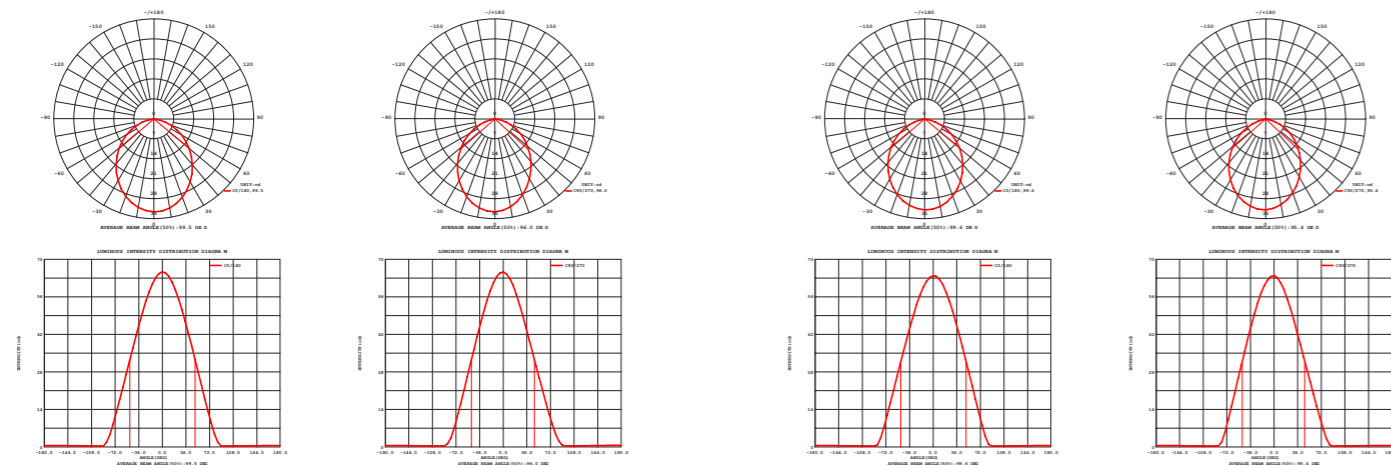

× Modos Instalación-Installation Forms



Con tubo carcasa-Recessed tube housing



76mm



Con pinzas-With clips



74mm



## CONEXIÓN IP68

Outdoor

**TUV**

REFERENCE	OPERATING RATING	VOLTAGE	AMPERE	WIRE SECTION	OUTER CABLE DIAMETER	IP
TU0662	-40°C + 105C	400V AC	17,5A	0.5 mm <sup>2</sup> - 1,5 mm <sup>2</sup>	3,5 mm-7,0mm; 7mm-10mm	68
TU0663	-40°C + 105C	400V AC	24A	0.5 mm <sup>2</sup> - 2,5 mm <sup>2</sup>	5 mm-9mm; 9mm-12mm	68

PC-PC PA66 Nylon

TU0662



TU0663



## PIQUETAS

Complementos exterior-Outdoor complements

REFERENCE	DESCRIPCIÓN	ACABADO	TAMAÑO
TU0492	Piqueta 16cm	Negro-Black	40•160 mm
TU0652	Piqueta 21cm	Negro-Black	45•210 mm
TU0653	Piqueta 26cm	Negro-Black	55•270 mm
TU0494	Disco para suelo	Negro-Black	ø50 mm

Aluminio-Aluminium

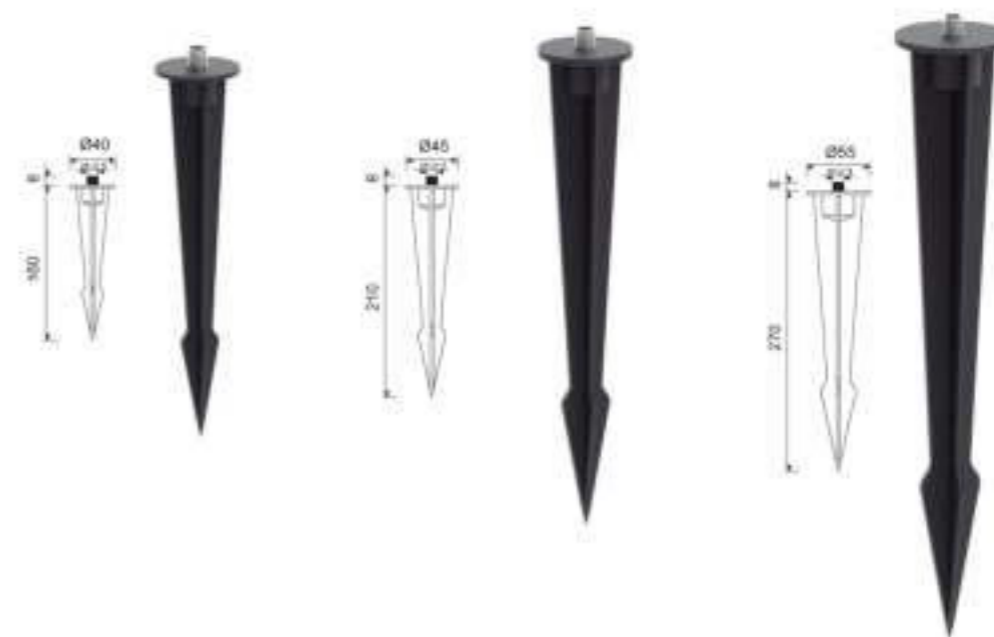

## Base sujeción/Fixing base

TU0494



## LED G9 Bulb

### Características

- \* Voltaje: AC 220-240V 50/60Hz 12mA
- \* 20,000 hrs. vida útil
- \* Encendido instantáneo con potencia total
- \* Perfecta para reemplazar la lámpara incandescente de 25W
- \* Baja temperatura al tacto
- \* Libre de mercurio, Libre de emisión UV & IR
- \* Esta lámpara no es idónea para la iluminación de acentuación

### Features

- \* Voltage: AC 220-240V 50/60Hz 12mA
- \* 20,000hrs long life time
- \* Instant start with full bright output flick free
- \* Perfect replacement for 25W incandescent Bulb
- \* Low temperature, safety to touch
- \* No UV or IR emission, mercury FREE
- \* This lamp is not suitable for accent lighting

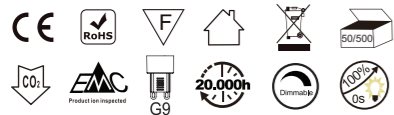

2.5W G9 230 Lumen



2.5W LED



25W Incandescent lamp (Lux.)



Item No.	R09184	R09185
Potencia nominal/Wattage(W)	2.5	
Temperatura de color/CCT(K)	2700K	5000K
Flujo luminoso/Luminous Flux(lm)	220	230
Tension nominal/Voltage(V)	AC 220-240V 50/60Hz	
Regulable/Dimmable	YES	
CRI	≥80	
Casquillo/Lamp Head	G9	
Angulo/Beam Angle(deg)	360°	
Material	PC	
Dimensiones/Dimensions(mm)	Φ16*48	

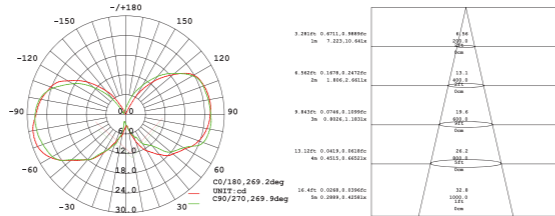

## LED G9 Bulb

### Características

- \* Voltaje: AC 220-240V 50/60Hz 25mA
- \* 20,000 hrs. vida útil
- \* Encendido instantáneo con potencia total
- \* Perfecta para reemplazar la lámpara incandescente de 30W
- \* Baja temperatura al tacto
- \* Libre de mercurio, Libre de emisión UV & IR
- \* Esta lámpara no es idónea para la iluminación de acentuación

### Features

- \* Voltage: AC 220-240V 50/60Hz 25mA
- \* 20,000hrs long life time
- \* Instant start with full bright output flick free
- \* Perfect replacement for 30W incandescent Bulb
- \* Low temperature, safety to touch
- \* No UV or IR emission, mercury FREE
- \* This lamp is not suitable for accent lighting

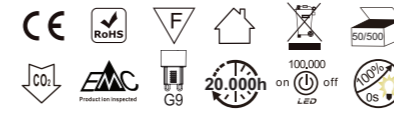

3W G9 268 Lumen



3W LED



30W Incandescent lamp (Lux.)



Item No.	R09182
Potencia nominal/Wattage(W)	3
Temperatura de color/CCT(K)	2700K
Flujo luminoso/Luminous Flux(lm)	268
Tension nominal/Voltage(V)	AC 220-240V 50/60Hz
Regulable/Dimmable	NO
CRI	≥80
Casquillo/Lamp Head	G9
Angulo/Beam Angle(deg)	360°
Material	Ceramic / PC
Dimensiones/Dimensions(mm)	Φ19*50

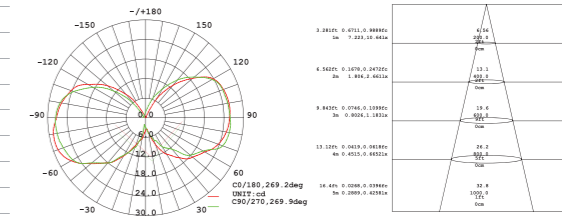

## LED G9 Bulb

### Características

- \* Voltaje: AC 220-240V 50/60Hz 10mA
- \* 20,000 hrs. vida útil
- \* Encendido instantáneo con potencia total
- \* Perfecta para reemplazar la lámpara incandescente de 30W
- \* Baja temperatura al tacto
- \* Libre de mercurio, Libre de emisión UV & IR
- \* Esta lámpara no es idónea para la iluminación de acentuación

### Features

- \* Voltage: AC 220-240V 50Hz 10mA
- \* 20,000hrs long life time
- \* Instant start with full bright output flick free
- \* Perfect replacement for 30W incandescent Bulb
- \* Low temperature, safety to touch
- \* No UV or IR emission, mercury FREE
- \* This lamp is not suitable for accent lighting

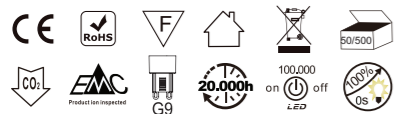

2.5W G9 250 Lumen



2.5W LED



30W Incandescent lamp (Lux.)

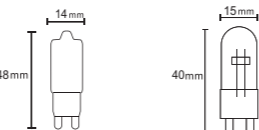

Item No.	R09226	R09227
Potencia nominal/Wattage(W)	2.5	
Temperatura de color/CCT(K)	3000K	4000K
Flujo luminoso/Luminous Flux(lm)	240	250
Tension nominal/Voltage(V)	AC 220-240V 50/60Hz	
Regulable/Dimmable	NO	
CRI	≥80	
Casquillo/Lamp Head	G9	
Angulo/Beam Angle(deg)	360°	
Material	Cristal / Glass	
Dimensiones/Dimensions(mm)	Φ14*48	

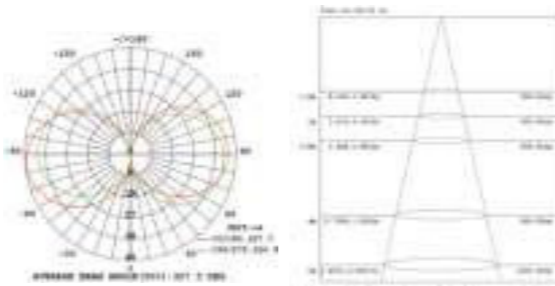

## LED G9 Bulb

### Características

- \* Voltaje: AC 220-240V 50/60Hz 30mA
- \* 20,000 hrs. vida útil
- \* Encendido instantáneo con potencia total
- \* Perfecta para reemplazar la lámpara incandescente de 30W
- \* Baja temperatura al tacto
- \* Libre de mercurio, Libre de emisión UV & IR
- \* Esta lámpara no es idónea para la iluminación de acentuación

### Features

- \* Voltage: AC 220-240V 50/60Hz 30mA
- \* 20,000hrs long life time
- \* Instant start with full bright output flick free
- \* Perfect replacement for 30W incandescent Bulb
- \* Low temperature, safety to touch
- \* No UV or IR emission, mercury FREE
- \* This lamp is not suitable for accent lighting

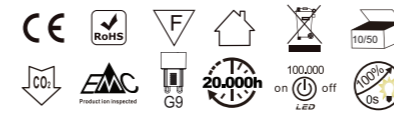

3.5W G9 375 Lumen



3.5W LED



30W Incandescent lamp (Lux.)

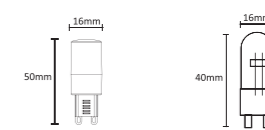

Item No.	R09202	R09203
Potencia nominal/Wattage(W)	3.5	
Temperatura de color/CCT(K)	2700K	5000K
Flujo luminoso/Luminous Flux(lm)	360	375
Tension nominal/Voltage(V)	AC 220-240V 50/60Hz	
Regulable/Dimmable	NO	
CRI	≥80	
Casquillo/Lamp Head	G9	
Angulo/Beam Angle(deg)	360°	
Material	Ceramic / PCB	
Dimensiones/Dimensions(mm)	Φ16*50	

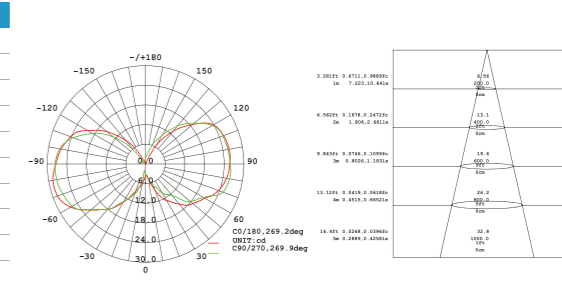

## LED G4 Bulb

### Características

- \* Voltaje: AC/DC 12V 140mA
- \* 20,000 hrs. vida útil
- \* Encendido instantáneo con potencia total
- \* Perfecta para reemplazar la lámpara incandescente de 20W
- \* Baja temperatura al tacto
- \* Libre de mercurio, Libre de emisión UV & IR
- \* Esta lámpara no es idónea para la iluminación de acentuación

### Features

- \* Voltage: AC/DC 12V 140mA
- \* 20,000hrs long life time
- \* Instant start with full bright output flick free
- \* Perfect replacement for 20W incandescent Bulb
- \* Low temperature, safety to touch
- \* No UV or IR emission, mercury FREE
- \* This lamp is not suitable for accent lighting

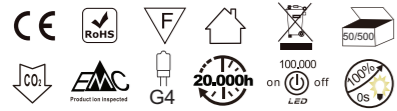

2W G4 190 Lumen

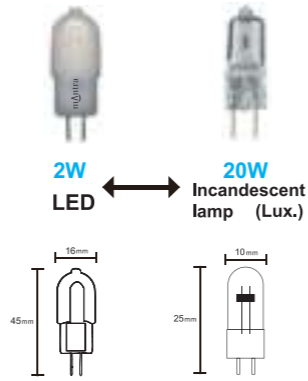

Item No.	R09209	R09210
Potencia nominal/Wattage(W)	2	2
Temperatura de color/CCT(K)	3000K	5000K
Flujo luminoso/Luminous Flux(lm)	190	190
Tension nominal/Voltage(V)	AC/DC 12V	AC/DC 12V
Regulable/Dimmable	NO	NO
CRI	≥80	≥80
Casquillo/Lamp Head	G4	G4
Angulo/Beam Angle(deg)	240°	240°
Material	PC	PC
Dimensiones/Dimensions(mm)	L16*W12*H45	L16*W12*H45

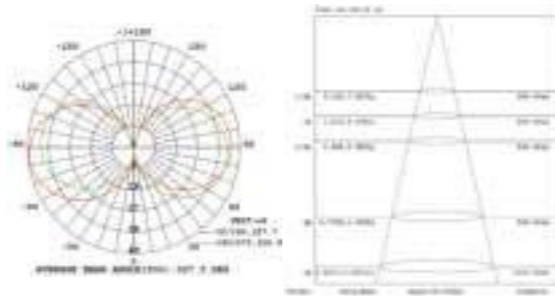

## LED GU10 Bulb

### Características

- \* 15,000 hrs. vida útil
- \* Encendido instantáneo con potencia total
- \* Perfecta para reemplazar la lámpara incandescente de 75W
- \* Baja temperatura al tacto
- \* Libre de mercurio, Libre de emisión UV & IR
- \* Esta lámpara no es idónea para la iluminación de acentuación

### Features

- \* 15,000hrs long life time
- \* Instant start with full bright output flick free
- \* Perfect replacement for 75W incandescent Bulb
- \* Low temperature, safety to touch
- \* No UV or IR emission, mercury FREE
- \* This lamp is not suitable for accent lighting



Dimmable  
9W GU10 820 Lumen

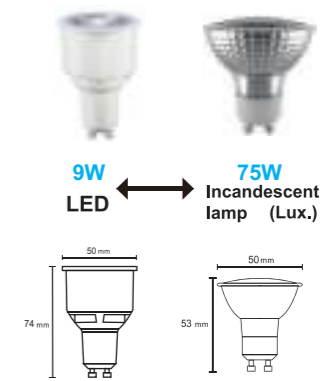

Item No.	R09218	R09219	R09220
Potencia nominal/Wattage(W)	9	9	9
Temperatura de color/CCT(K)	3000K	3000K	4000K
Flujo luminoso/Luminous Flux(lm)	800	800	820
Tension nominal/Voltage(V)	AC 220-240V 50/60Hz	AC 100-240V 50/60Hz	AC 100-240V 50/60Hz
Regulable/Dimmable	YES	NO	NO
CRI	≥80	≥80	≥80
Casquillo/Lamp Head	GU10	GU10	GU10
Angulo/Beam Angle(deg)	50°	50°	50°
Material	Aluminio+PC/Aluminum+PC	Aluminio+PC/Aluminum+PC	Aluminio+PC/Aluminum+PC
Dimensiones/Dimensions(mm)	Φ50*74	Φ50*74	Φ50*74

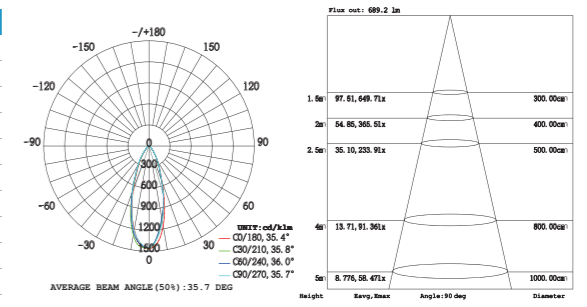

## LED G4 Bulb

### Características

- \* Voltaje: AC/DC 12V 345mA
- \* 20,000 hrs. vida útil
- \* Encendido instantáneo con potencia total
- \* Perfecta para reemplazar la lámpara incandescente de 35W
- \* Baja temperatura al tacto
- \* Libre de mercurio, Libre de emisión UV & IR
- \* Esta lámpara no es idónea para la iluminación de acentuación

### Features

- \* Voltage: AC/DC 12V 345mA
- \* 20,000hrs long life time
- \* Instant start with full bright output flick free
- \* Perfect replacement for 35W incandescent Bulb
- \* Low temperature, safety to touch
- \* No UV or IR emission, mercury FREE
- \* This lamp is not suitable for accent lighting

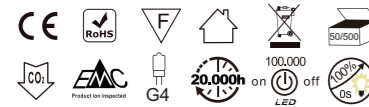

5W G4 500 Lumen

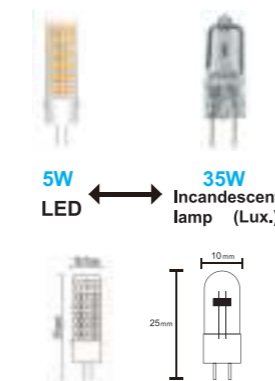

Item No.	R09243	R09247
Potencia nominal/Wattage(W)	5	5
Temperatura de color/CCT(K)	3000K	4000K
Flujo luminoso/Luminous Flux(lm)	500	500
Tension nominal/Voltage (V)	AC/DC 12V	AC/DC 12V
Regulable/Dimmable	NO	NO
CRI	≥80	≥80
Casquillo/Lamp Head	G4	G4
Angulo/Beam Angle(deg)	360°	360°
Material	PCB&Ceramic	PCB&Ceramic
Dimensiones/Dimensions(mm)	Φ19*57	Φ19*57

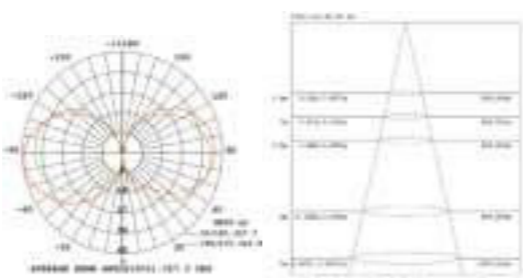

## LED GU10 Bulb

### Características

- \* Voltaje: AC 220-240V 50/60Hz 40mA
- \* 15,000 hrs. vida útil
- \* Encendido instantáneo con potencia total
- \* Perfecta para reemplazar la lámpara incandescente de 35W
- \* Baja temperatura al tacto
- \* Libre de mercurio, Libre de emisión UV & IR
- \* Esta lámpara no es idónea para la iluminación de acentuación

### Features

- \* Voltage: AC 220-240V 50/60Hz 40mA
- \* 15,000hrs long life time
- \* Instant start with full bright output flick free
- \* Perfect replacement for 35W incandescent Bulb
- \* Low temperature, safety to touch
- \* No UV or IR emission, mercury FREE
- \* This lamp is not suitable for accent lighting



4W GU10 360 Lumen

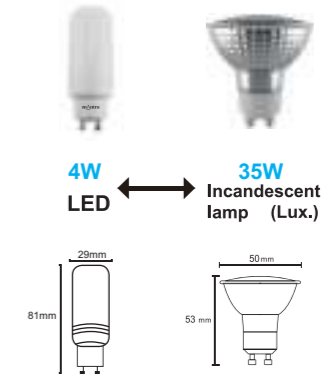

Item No.	R09207
Potencia nominal/Wattage(W)	4
Temperatura de color/CCT(K)	3000K
Flujo luminoso/Luminous Flux(lm)	360
Tension nominal/Voltage(V)	AC 220-240V 50/60Hz
Regulable/Dimmable	NO
CRI	≥80
Casquillo/Lamp Head	GU10
Angulo/Beam Angle(deg)	360°
Material	Aluminio+PC/Aluminum+PC
Dimensiones/Dimensions(mm)	Φ29*81

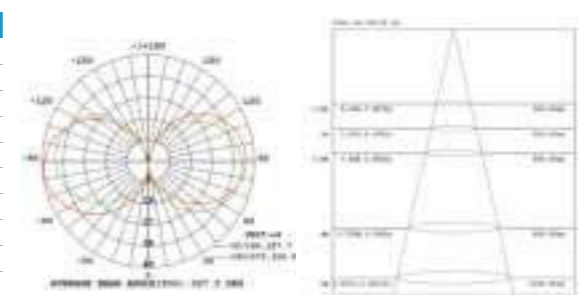



## LED GU10 Bulb

### Características

- \* Voltaje: AC 220-240V 50/60Hz 60mA
- \* 15,000 hrs. vida útil
- \* Encendido instantaneo con potencia total
- \* Perfecta para reemplazar la lampara incandescente de 80W
- \* Baja temperatura al tacto
- \* Libre de mercurio, Libre de emision UV & IR
- \* Esta lampara no es idonea para la iluminacion de acentuacion

### Features

- \* Voltage: AC 220-240V 50/60Hz 60mA
- \* 15,000hrs long life time
- \* Instant start with full bright output flick free
- \* Perfect replacement for 80W incandescent Bulb
- \* Low temperature, safety to touch
- \* No UV or IR emission, mercury FREE
- \* This lamp is not suitable for accent lighting



8W GU10 641 Lumen



8W LED ↔ 80W Incandescent lamp (Lux.)

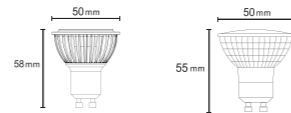

Item No.	R09156	R09157
Potencia nominal/Wattage(W)	8	
Temperatura de color/CCT(K)	3000K	5000K
Flujo luminoso/Luminous Flux(lm)	641	
Tension nominal/Voltage(V)	AC 220-240V 50/60Hz	
Regulable/Dimmable	NO	
CRI	≥80	
Casquillo/Lamp Head	GU10	
Angulo/Beam Angle(deg)	60°	
Material	Aluminio&PC / Aluminum&PC	
Dimensiones/Dimensions(mm)	Φ50*58	

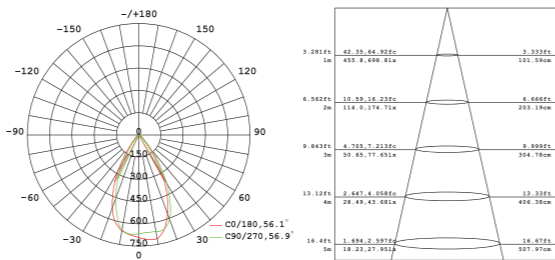

## LED GU10 Bulb

### Características

- \* Voltaje: AC 220-240V 50/60Hz 55mA
- \* 15,000 hrs. vida útil
- \* Encendido instantaneo con potencia total
- \* Perfecta para reemplazar la lampara incandescente de 60W
- \* Baja temperatura al tacto
- \* Libre de mercurio, Libre de emision UV & IR
- \* Esta lampara no es idonea para la iluminacion de acentuacion

### Features

- \* Voltage: AC 220-240V 50/60Hz 55mA
- \* 15,000hrs long life time
- \* Instant start with full bright output flick free
- \* Perfect replacement for 60W incandescent Bulb
- \* Low temperature, safety to touch
- \* No UV or IR emission, mercury FREE
- \* This lamp is not suitable for accent lighting



6W GU10 540 Lumen



6W LED ↔ 60W Incandescent lamp (Lux.)

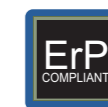
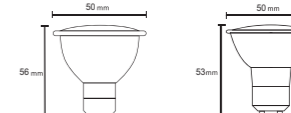

Item No.	R09196	R09214	R09197
Potencia nominal/Wattage(W)	6		
Temperatura de color/CCT(K)	3000K	4000K	5000K
Flujo luminoso/Luminous Flux(lm)	520	540	540
Tension nominal/Voltage(V)	AC 220-240V 50/60Hz		
Regulable/Dimmable	NO		
CRI	≥80		
Casquillo/Lamp Head	GU10		
Angulo/Beam Angle(deg)	110°		
Material	Aluminio+PC/Aluminum+PC		
Dimensiones/Dimensions(mm)	Φ50*56		

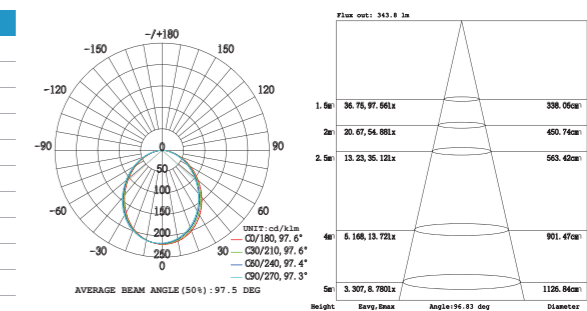

## LED GU10 Bulb

### Características

- \* Voltaje: AC 220-240V 50/60Hz 50mA
- \* 15,000 hrs. vida útil
- \* Encendido instantaneo con potencia total
- \* Perfecta para reemplazar la lampara incandescente de 60W
- \* Baja temperatura al tacto
- \* Libre de mercurio, Libre de emision UV & IR
- \* Esta lampara no es idonea para la iluminacion de acentuacion

### Features

- \* Voltage: AC 220-240V 50/60Hz 50mA
- \* 15,000hrs long life time
- \* Instant start with full bright output flick free
- \* Perfect replacement for 60W incandescent Bulb
- \* Low temperature, safety to touch
- \* No UV or IR emission, mercury FREE
- \* This lamp is not suitable for accent lighting



6W GU10 515 Lumen



6W LED ↔ 60W Incandescent lamp (Lux.)

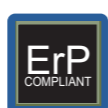
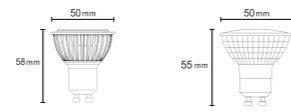

Item No.	R09158	R09159
Potencia nominal/Wattage(W)	6	
Temperatura de color/CCT(K)	3000K	5000K
Flujo luminoso/Luminous Flux(lm)	484	515
Tension nominal/Voltage(V)	AC 220-240V 50/60Hz	
Regulable/Dimmable	NO	
CRI	≥80	
Casquillo/Lamp Head	GU10	
Angulo/Beam Angle(deg)	60°	
Material	Aluminio+PC / Aluminum+PC	
Dimensiones/Dimensions(mm)	Φ50*58	

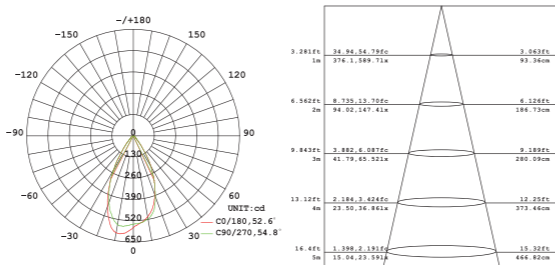

## LED GU10 Bulb

### Características

- \* Voltaje: AC 220-240V 50/60Hz 30mA
- \* 15,000 hrs. vida útil
- \* Encendido instantaneo con potencia total
- \* Perfecta para reemplazar la lampara incandescente de 35W
- \* Baja temperatura al tacto
- \* Libre de mercurio, Libre de emision UV & IR
- \* Esta lampara no es idonea para la iluminacion de acentuacion

### Features

- \* Voltage: AC 220-240V 50/60Hz 30mA
- \* 15,000hrs long life time
- \* Instant start with full bright output flick free
- \* Perfect replacement for 35W incandescent Bulb
- \* Low temperature, safety to touch
- \* No UV or IR emission, mercury FREE
- \* This lamp is not suitable for accent lighting



4W GU10 320 Lumen



4W LED ↔ 35W Incandescent lamp (Lux.)

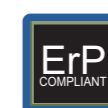
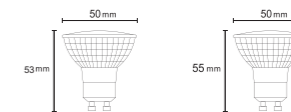

Item No.	R09194	R09195
Potencia nominal/Wattage(W)	4	
Temperatura de color/CCT(K)	3000K	5000K
Flujo luminoso/Luminous Flux(lm)	300	320
Tension nominal/Voltage(V)	AC 220-240V 50/60Hz	
Regulable/Dimmable	NO	
CRI	≥80	
Casquillo/Lamp Head	GU10	
Angulo/Beam Angle(deg)	110°	
Material	Aluminio+Cristal/Aluminum+Glass	
Dimensiones/Dimensions(mm)	Φ50*53	

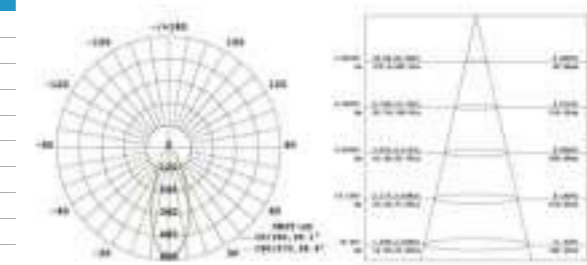

## LED GU10 Bulb New

### Características

- \* Voltaje: AC 220-240V 50/60Hz 34mA
- \* 15,000 hrs. vida útil
- \* Encendido instantaneo con potencia total
- \* Perfecta para reemplazar la lampara incandescente de 60W
- \* Baja temperatura al tacto
- \* Libre de mercurio, Libre de emision UV & IR
- \* Esta lampara no es idonea para la iluminacion de acentuacion

### Features

- \* Voltage: AC 220-240V 50/60Hz 34mA
- \* 15,000hrs long life time
- \* Instant start with full bright output flick free
- \* Perfect replacement for 60W incandescent Bulb
- \* Low temperature, safety to touch
- \* No UV or IR emission, mercury FREE
- \* This lamp is not suitable for accent lighting



7W GU10 570 Lumen



Item No.	R09254	R09255	R09256
Potencia nominal/Wattage(W)		7	
Temperatura de color/CCT(K)	2700K	3000K	4000K
Flujo luminoso/Luminous Flux(lm)	510	540	570
Tension nominal/Voltage(V)	AC 220-240V 50/60Hz		
Regulable/Dimmable	NO		
CRI	≥80		
Casquillo/Lamp Head	GU10		
Angulo/Beam Angle(deg)	50°		
Material	Aluminio+PC/Aluminum+PC		
Dimensiones/Dimensions(mm)	Φ50*56		

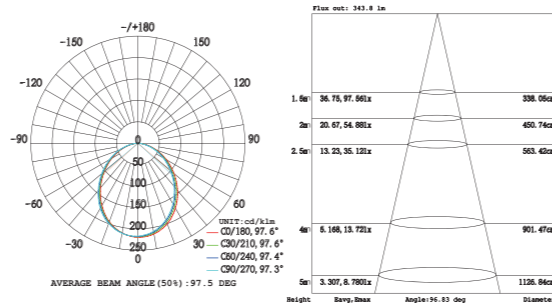

## LED E14 Bulb

### Características

- \* Voltaje: AC 220-240V 50/60Hz 35mA
- \* 15,000 hrs. vida útil
- \* Encendido instantaneo con potencia total
- \* Perfecta para reemplazar la lampara incandescente de 40W
- \* Baja temperatura al tacto
- \* Libre de mercurio, Libre de emision UV & IR
- \* Esta lampara no es idonea para la iluminacion de acentuacion

### Features

- \* Voltage: AC 220-240V 50/60Hz 35mA
- \* 15,000hrs long life time
- \* Instant start with full bright output flick free
- \* Perfect replacement for 40W incandescent Bulb
- \* Low temperature, safety to touch
- \* No UV or IR emission, mercury FREE
- \* This lamp is not suitable for accent lighting



4W E14 470 Lumen

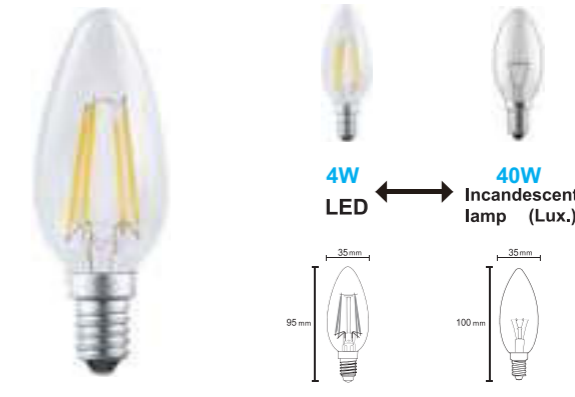

Item No.	R09115
Potencia nominal/Wattage(W)	4
Temperatura de color/CCT(K)	2700K
Flujo luminoso/Luminous Flux(lm)	470
Tension nominal/Voltage(V)	AC 220-240V 50/60Hz
Regulable/Dimmable	NO
CRI	≥80
Casquillo/Lamp Head	E14
Angulo/Beam Angle(deg)	360°
Material	Aluminio+Cristal/Aluminum+Glass
Dimensiones/Dimensions(mm)	Φ35*95

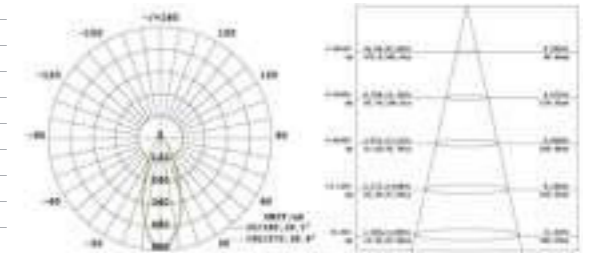

## LED GU10 Bulb New

### Características

- \* Voltaje: AC 220-240V 50/60Hz 30mA
- \* 15,000 hrs. vida útil
- \* Encendido instantaneo con potencia total
- \* Perfecta para reemplazar la lampara incandescente de 60W
- \* Baja temperatura al tacto
- \* Libre de mercurio, Libre de emision UV & IR
- \* Esta lampara no es idonea para la iluminacion de acentuacion

### Features

- \* Voltage: AC 220-240V 50/60Hz 30mA
- \* 15,000hrs long life time
- \* Instant start with full bright output flick free
- \* Perfect replacement for 60W incandescent Bulb
- \* Low temperature, safety to touch
- \* No UV or IR emission, mercury FREE
- \* This lamp is not suitable for accent lighting



7W GU10 570 Lumen  
DIMMABLE



Item No.	R09257	R09258	R09259
Potencia nominal/Wattage(W)		7	
Temperatura de color/CCT(K)	2700K	3000K	4000K
Flujo luminoso/Luminous Flux(lm)	510	540	570
Tension nominal/Voltage(V)	AC 220-240V 50/60Hz		
Regulable/Dimmable	YES		
CRI	≥80		
Casquillo/Lamp Head	GU10		
Angulo/Beam Angle(deg)	50°		
Material	Aluminio+Cristal/Aluminum+Glass		
Dimensiones/Dimensions(mm)	Φ50*56		

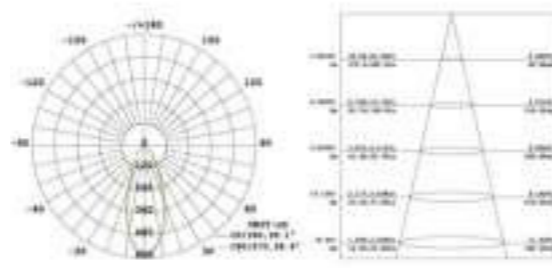

## LED E14 Bulb

### Características

- \* Voltaje: AC 220-240V 50/60Hz 35mA
- \* 15,000 hrs. vida útil
- \* Encendido instantaneo con potencia total
- \* Perfecta para reemplazar la lampara incandescente de 40W
- \* Baja temperatura al tacto
- \* Libre de mercurio, Libre de emision UV & IR
- \* Esta lampara no es idonea para la iluminacion de acentuacion

### Features

- \* Voltage: AC 220-240V 50/60Hz 35mA
- \* 15,000hrs long life time
- \* Instant start with full bright output flick free
- \* Perfect replacement for 40W incandescent Bulb
- \* Low temperature, safety to touch
- \* No UV or IR emission, mercury FREE
- \* This lamp is not suitable for accent lighting



4W E14 340 Lumen

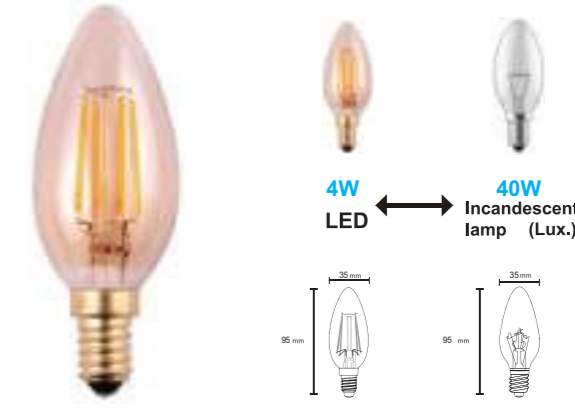

Item No.	R09208
Potencia nominal/Wattage(W)	4
Temperatura de color/CCT(K)	2200K
Flujo luminoso/Luminous Flux(lm)	340
Tension nominal/Voltage(V)	AC 220-240V 50/60Hz
Regulable/Dimmable	NO
CRI	≥80
Casquillo/Lamp Head	E14
Angulo/Beam Angle(deg)	360°
Material	Aluminio+Cristal/Aluminum+Glass
Dimensiones/Dimensions(mm)	Φ35*95

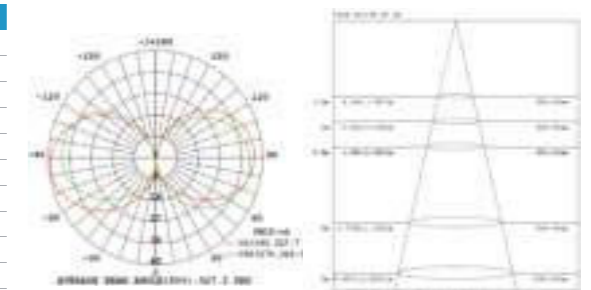

## LED E14 Bulb

### Características

- \* Voltaje: AC 220-240V 50/60Hz 35mA
- \* 15,000 hrs. vida útil
- \* Encendido instantaneo con potencia total
- \* Perfecta para reemplazar la lampara incandescente de 40W
- \* Baja temperatura al tacto
- \* Libre de mercurio, Libre de emision UV & IR
- \* Esta lampara no es idonea para la iluminacion de acentuacion

### Features

- \* Voltage: AC 220-240V 50/60Hz 35mA
- \* 15,000hrs long life time
- \* Instant start with full bright output flick free
- \* Perfect replacement for 40W incandescent Bulb
- \* Low temperature, safety to touch
- \* No UV or IR emission, mercury FREE
- \* This lamp is not suitable for accent lighting



4W E14 470 Lumen



4W LED ↔ 40W Incandescent lamp (Lux.)

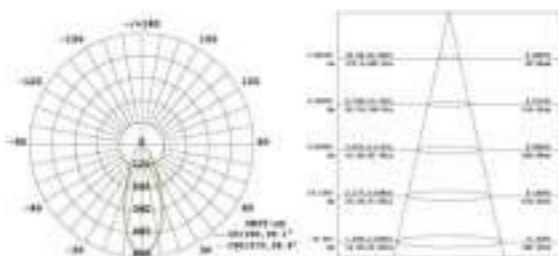
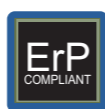
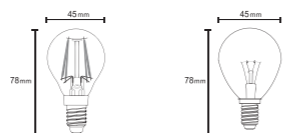

Item No.	R09114
Potencia nominal/Wattage(W)	4
Temperatura de color/CCT(K)	2700K
Flujo luminoso/Luminous Flux(lm)	470
Tension nominal/Voltage(V)	AC 220-240V 50/60Hz
Regulable/Dimmable	NO
CRI	≥80
Casquillo/Lamp Head	E14
Angulo/Beam Angle(deg)	360°
Material	Aluminio+Cristal/Aluminum+Glass
Dimensiones/Dimensions(mm)	Φ45*78

## LED E14 Bulb

### Características

- \* Voltaje: AC 220-240V 50/60Hz 45mA
- \* 15,000 hrs. vida útil
- \* Encendido instantaneo con potencia total
- \* Perfecta para reemplazar la lampara incandescente de 40W
- \* Baja temperatura al tacto
- \* Libre de mercurio, Libre de emision UV & IR
- \* Esta lampara no es idonea para la iluminacion de acentuacion

### Features

- \* Voltage: AC 220-240V 50/60Hz 45mA
- \* 15,000hrs long life time
- \* Instant start with full bright output flick free
- \* Perfect replacement for 40W incandescent Bulb
- \* Low temperature, safety to touch
- \* No UV or IR emission, mercury FREE
- \* This lamp is not suitable for accent lighting



5.5W E14 490 Lumen



5.5W LED ↔ 40W Incandescent lamp (Lux.)

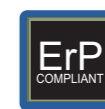
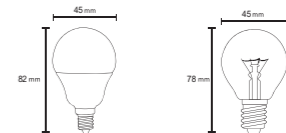

Item No.	R09117	R09221	R09118
Potencia nominal/Wattage(W)		5.5	
Temperatura de color/CCT(K)	3000K	4000K	5000K
Flujo luminoso/Luminous Flux(lm)	470	480	490
Tension nominal/Voltage(V)	AC 220-240V 50/60Hz		
Regulable/Dimmable	NO		
CRI	≥80		
Casquillo/Lamp Head	E14		
Angulo/Beam Angle(deg)	140°		
Material	Aluminio+PC+Cristal/Aluminum+PC+Glass		
Dimensiones/Dimensions(mm)	Φ45*82		

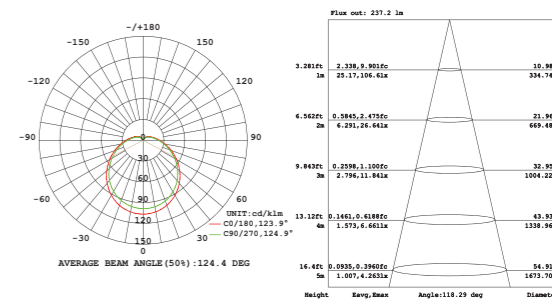

## LED E14 Bulb

### Características

- \* Voltaje: AC 220-240V 50/60Hz 35mA
- \* 15,000 hrs. vida útil
- \* Encendido instantaneo con potencia total
- \* Perfecta para reemplazar la lampara incandescente de 40W
- \* Baja temperatura al tacto
- \* Libre de mercurio, Libre de emision UV & IR
- \* Esta lampara no es idonea para la iluminacion de acentuacion

### Features

- \* Voltage: AC 220-240V 50/60Hz 35mA
- \* 15,000hrs long life time
- \* Instant start with full bright output flick free
- \* Perfect replacement for 40W incandescent Bulb
- \* Low temperature, safety to touch
- \* No UV or IR emission, mercury FREE
- \* This lamp is not suitable for accent lighting



4W E14 470 Lumen



4W LED ↔ 40W Incandescent lamp (Lux.)

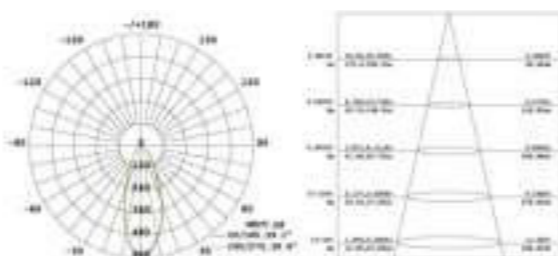
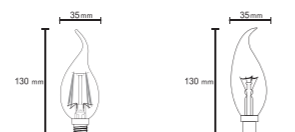

Item No.	R09116
Potencia nominal/Wattage(W)	4
Temperatura de color/CCT(K)	2700K
Flujo luminoso/Luminous Flux(lm)	470
Tension nominal/Voltage(V)	AC 220-240V 50/60Hz
Regulable/Dimmable	NO
CRI	≥80
Casquillo/Lamp Head	E14
Angulo/Beam Angle(deg)	360°
Material	Aluminio+Cristal/Aluminum+Glass
Dimensiones/Dimensions(mm)	Φ35*130

## LED E14 Bulb

### Características

- \* Voltaje: AC 220-240V 50/60Hz 35mA
- \* 15,000 hrs. vida útil
- \* Encendido instantaneo con potencia total
- \* Perfecta para reemplazar la lampara incandescente de 40W
- \* Baja temperatura al tacto
- \* Libre de mercurio, Libre de emision UV & IR
- \* Esta lampara no es idonea para la iluminacion de acentuacion

### Features

- \* Voltage: AC 220-240V 50/60Hz 35mA
- \* 15,000hrs long life time
- \* Instant start with full bright output flick free
- \* Perfect replacement for 40W incandescent Bulb
- \* Low temperature, safety to touch
- \* No UV or IR emission, mercury FREE
- \* This lamp is not suitable for accent lighting



4W E14 470 Lumen



4W LED ↔ 40W Incandescent lamp (Lux.)

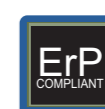
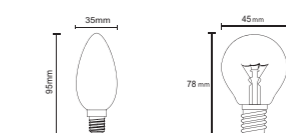

Item No.	R09241	R09242
Potencia nominal/Wattage(W)	4	
Temperatura de color/CCT(K)	3000K	4000K
Flujo luminoso/Luminous Flux(lm)	470	485
Tension nominal/Voltage(V)	AC 220-240V 50/60Hz	
Regulable/Dimmable	NO	
CRI	≥80	
Casquillo/Lamp Head	E14	
Angulo/Beam Angle(deg)	360°	
Material	Aluminio+PC+Cristal/Aluminum+PC+Glass	
Dimensiones/Dimensions(mm)	Φ35*95	

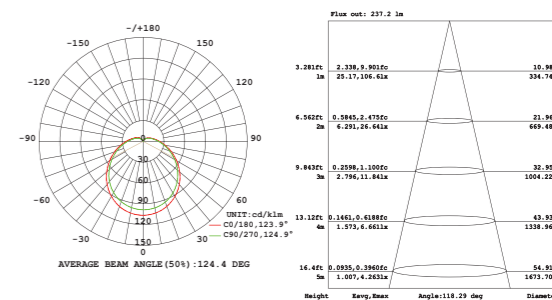

## LED E14 Bulb

### Características

- \* Voltaje: AC 220-240V/50Hz 55mA
- \* 15,000 hrs. vida útil
- \* Encendido instantaneo con potencia total
- \* Perfecta para reemplazar la lampara incandescente de 60W
- \* Baja temperatura al tacto
- \* Libre de mercurio, Libre de emision UV & IR
- \* Esta lampara no es idonea para la iluminacion de acentuacion

### Features

- \* Voltage: AC 220-240V/50Hz 55mA
- \* 15,000hrs long life time
- \* Instant start with full bright output flick free
- \* Perfect replacement for 60W incandescent Bulb
- \* Low temperature, safety to touch
- \* No UV or IR emission, mercury FREE
- \* This lamp is not suitable for accent lighting



6.5W E14 800 Lumen

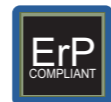
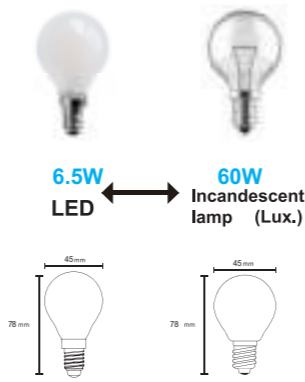

Item No.	R09239	R09240
Potencia nominal/Wattage(W)		6.5
Temperatura de color/CCT(K)	3000K	4000K
Flujo luminoso/Luminous Flux(lm)	790	800
Tension nominal/Voltage(V)	AC 220-240V/50Hz	
Regulable/Dimmable	NO	
CRI	≥80	
Casquillo/Lamp Head	E14	
Angulo/Beam Angle(deg)	360°	
Material	Aluminio+Cristal/Aluminum+Glass	
Dimensiones/Dimensions(mm)	Φ45*78	

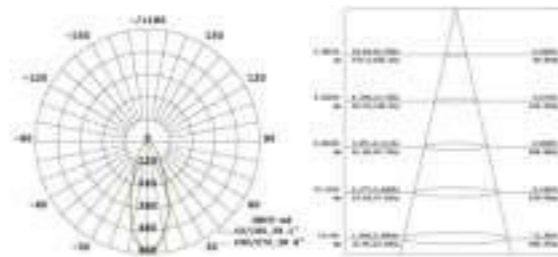

## LED E27 Bulb

### Características

- \* Voltaje: AC 220-240V 50/60Hz 55mA
- \* 15,000 hrs. vida útil
- \* Encendido instantaneo con potencia total
- \* Perfecta para reemplazar la lampara incandescente de 75W
- \* Baja temperatura al tacto
- \* Libre de mercurio, Libre de emision UV & IR
- \* Esta lampara no es idonea para la iluminacion de acentuacion

### Features

- \* Voltage: AC 220-240V 50/60Hz 55mA
- \* 15,000hrs long life time
- \* Instant start with full bright output flick free
- \* Perfect replacement for 75W incandescent Bulb
- \* Low temperature, safety to touch
- \* No UV or IR emission, mercury FREE
- \* This lamp is not suitable for accent lighting



10W E27 1050 Lumen

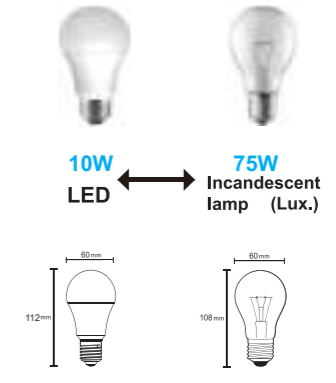

Item No.	R09133	R09215	R09134
Potencia nominal/Wattage(W)		10	
Temperatura de color/CCT(K)	3000K	4000K	5000K
Flujo luminoso/Luminous Flux(lm)	1055	1080	1100
Tension nominal/Voltage(V)	AC 220-240V 50/60Hz		
Regulable/Dimmable	NO		
CRI	≥80		
Casquillo/Lamp Head	E27		
Angulo/Beam Angle(deg)	320°		
Material	Aluminio+PC/Aluminum+PC		
Dimensiones/Dimensions(mm)	Φ60*112		

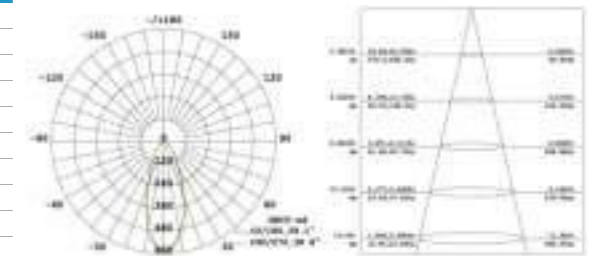

## LED E27 Bulb

### Características

- \* Voltaje: AC 220-240V/50Hz 55mA
- \* 15,000 hrs. vida útil
- \* Encendido instantaneo con potencia total
- \* Perfecta para reemplazar la lampara incandescente de 60W
- \* Baja temperatura al tacto
- \* Libre de mercurio, Libre de emision UV & IR
- \* Esta lampara no es idonea para la iluminacion de acentuacion

### Features

- \* Voltage: AC 220-240V/50Hz 55mA
- \* 15,000hrs long life time
- \* Instant start with full bright output flick free
- \* Perfect replacement for 60W incandescent Bulb
- \* Low temperature, safety to touch
- \* No UV or IR emission, mercury FREE
- \* This lamp is not suitable for accent lighting



6.5W E27 800 Lumen

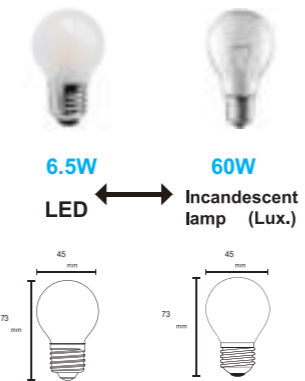

Item No.	R09237	R09238
Potencia nominal/Wattage(W)		6.5
Temperatura de color/CCT(K)	3000K	4000K
Flujo luminoso/Luminous Flux(lm)	790	800
Tension nominal/Voltage(V)	AC 220-240V/50Hz	
Regulable/Dimmable	NO	
CRI	≥80	
Casquillo/Lamp Head	E27	
Angulo/Beam Angle(deg)	360°	
Material	Aluminio+Cristal/Aluminum+Glass	
Dimensiones/Dimensions(mm)	Φ45*73	

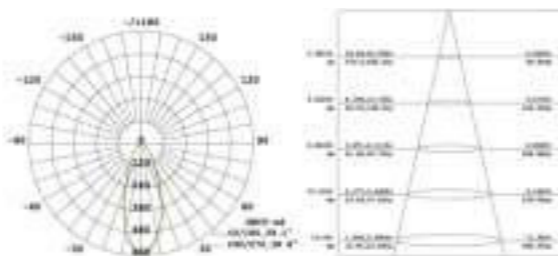

## LED E27 Bulb New

### Características

- \* Voltaje: AC 220-240V 50/60Hz 65mA
- \* 15,000 hrs. vida útil
- \* Encendido instantaneo con potencia total
- \* Perfecta para reemplazar la lampara incandescente de 100W
- \* Baja temperatura al tacto
- \* Libre de mercurio, Libre de emision UV & IR
- \* Esta lampara no es idonea para la iluminacion de acentuacion

### Features

- \* Voltage: AC 220-240V 50/60Hz 65mA
- \* 15,000hrs long life time
- \* Instant start with full bright output flick free
- \* Perfect replacement for 100W incandescent Bulb
- \* Low temperature, safety to touch
- \* No UV or IR emission, mercury FREE
- \* This lamp is not suitable for accent lighting



12W E27 1520 Lumen  
DIMMABLE

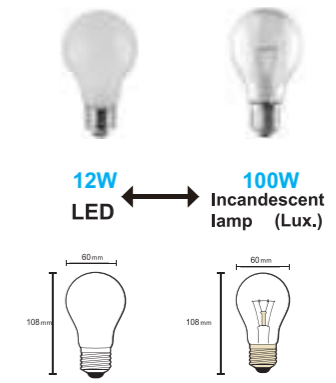

Item No.	R09251	R09252	R09253
Potencia nominal/Wattage(W)		12	
Temperatura de color/CCT(K)	2700K	3000K	4000K
Flujo luminoso/Luminous Flux(lm)	1440	1480	1520
Tension nominal/Voltage(V)	AC 220-240V 50/60Hz		
Regulable/Dimmable	YES		
CRI	≥80		
Casquillo/Lamp Head	E27		
Angulo/Beam Angle(deg)	360°		
Material	Aluminio+Cristal/Aluminum+Glass		
Dimensiones/Dimensions(mm)	Φ60*108		

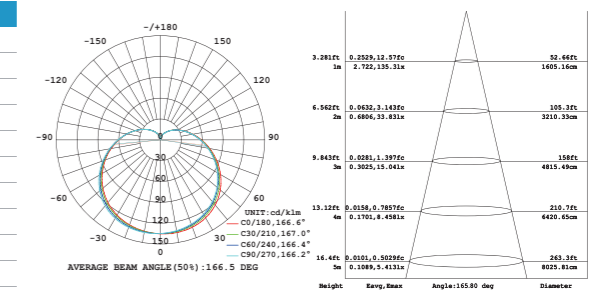

## LED E27 Bulb

### Características

- \* Voltaje: AC 220-240V 50/60Hz 56mA
- \* 15,000 hrs. vida útil
- \* Encendido instantáneo con potencia total
- \* Perfecta para reemplazar la lámpara incandescente de 60W
- \* Baja temperatura al tacto
- \* Libre de mercurio, Libre de emisión UV & IR
- \* Esta lámpara no es idónea para la iluminación de acentuación

### Features

- \* Voltage: AC 220-240V 50/60Hz 56mA
- \* 15,000hrs long life time
- \* Instant start with full bright output flick free
- \* Perfect replacement for 60W incandescent Bulb
- \* Low temperature, safety to touch
- \* No UV or IR emission, mercury FREE
- \* This lamp is not suitable for accent lighting



7W E27 800 Lumen

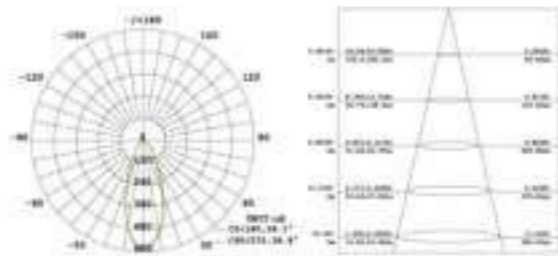
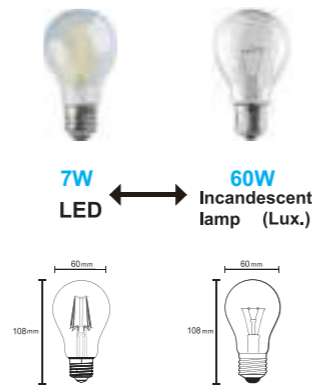

Item No.	R09131	R09250	R09211
Potencia nominal/Wattage(W)		7	
Temperatura de color/CCT(K)	2700K	3000K	4000K
Flujo luminoso/Luminous Flux(lm)		800	
Tension nominal/Voltage(V)	AC 220-240V 50/60Hz		
Regulable/Dimmable	NO		
CRI	≥80		
Casquillo/Lamp Head	E27		
Angulo/Beam Angle(deg)	360°		
Material	Cristal / Glass		
Dimensiones/Dimensions(mm)	Φ60*108		

## LED E27 Bulb

### Características

- \* Voltaje: AC 220-240V 50/60Hz 75mA
- \* 15,000 hrs. vida útil
- \* Encendido instantáneo con potencia total
- \* Perfecta para reemplazar la lámpara incandescente de 75W
- \* Baja temperatura al tacto
- \* Libre de mercurio, Libre de emisión UV & IR
- \* Esta lámpara no es idónea para la iluminación de acentuación

### Features

- \* Voltage: AC 220-240V 50/60Hz 75mA
- \* 15,000hrs long life time
- \* Instant start with full bright output flick free
- \* Perfect replacement for 55W incandescent Bulb
- \* Low temperature, safety to touch
- \* No UV or IR emission, mercury FREE
- \* This lamp is not suitable for accent lighting



9W E27 1055 Lumen

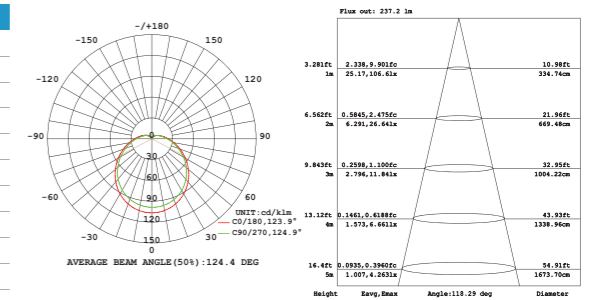
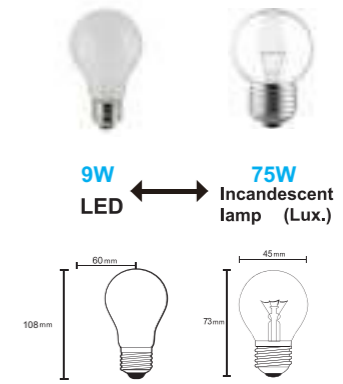

Item No.	R09234	R09235
Potencia nominal/Wattage(W)	9	
Temperatura de color/CCT(K)	3000K	4000K
Flujo luminoso/Luminous Flux(lm)	1055	1090
Tension nominal/Voltage(V)	AC 220-240V 50/60Hz	
Regulable/Dimmable	NO	
CRI	≥80	
Casquillo/Lamp Head	E27	
Angulo/Beam Angle(deg)	360°	
Material	Cristal+PC+Metal/Glass+PC+Metal	
Dimensiones/Dimensions(mm)	Φ60*108	

## LED E27 Bulb

### Características

- \* Voltaje: AC 220-240V 50/60Hz 35mA
- \* 15,000 hrs. vida útil
- \* Encendido instantáneo con potencia total
- \* Perfecta para reemplazar la lámpara incandescente de 40W
- \* Baja temperatura al tacto
- \* Libre de mercurio, Libre de emisión UV & IR
- \* Esta lámpara no es idónea para la iluminación de acentuación

### Features

- \* Voltage: AC 220-240V 50/60Hz 35mA
- \* 15,000hrs long life time
- \* Instant start with full bright output flick free
- \* Perfect replacement for 40W incandescent Bulb
- \* Low temperature, safety to touch
- \* No UV or IR emission, mercury FREE
- \* This lamp is not suitable for accent lighting



4W E27 470 Lumen

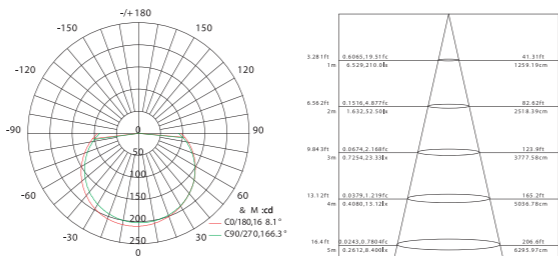
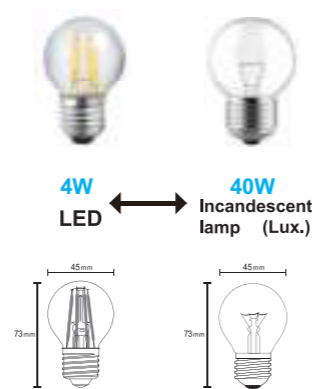

Item No.	R09132
Potencia nominal/Wattage(W)	4
Temperatura de color/CCT(K)	2700K
Flujo luminoso/Luminous Flux(lm)	470
Tension nominal/Voltage(V)	AC 220-240V 50/60Hz
Regulable/Dimmable	NO
CRI	≥80
Casquillo/Lamp Head	E27
Angulo/Beam Angle(deg)	360°
Material	Cristal / Glass
Dimensiones/Dimensions(mm)	Φ45*73

## LED E27 Bulb

### Características

- \* Voltaje: AC 220-240V 50/60Hz 45mA
- \* 15,000 hrs. vida útil
- \* Encendido instantáneo con potencia total
- \* Perfecta para reemplazar la lámpara incandescente de 40W
- \* Baja temperatura al tacto
- \* Libre de mercurio, Libre de emisión UV & IR
- \* Esta lámpara no es idónea para la iluminación de acentuación

### Features

- \* Voltage: AC 220-240V 50/60Hz 45mA
- \* 15,000hrs long life time
- \* Instant start with full bright output flick free
- \* Perfect replacement for 40W incandescent Bulb
- \* Low temperature, safety to touch
- \* No UV or IR emission, mercury FREE
- \* This lamp is not suitable for accent lighting



5.5W E27 490 Lumen

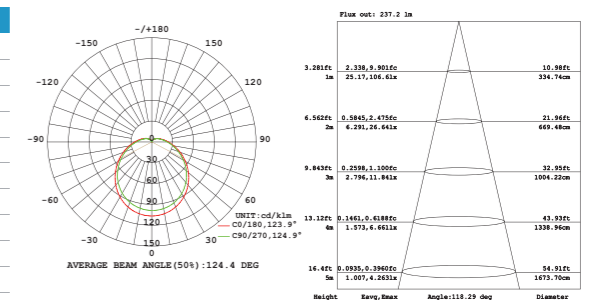
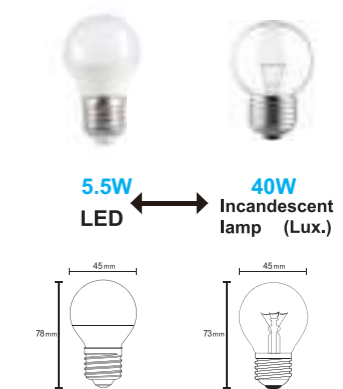

Item No.	R09135	R09223	R09136
Potencia nominal/Wattage(W)	5.5		
Temperatura de color/CCT(K)	3000K	4000K	5000K
Flujo luminoso/Luminous Flux(lm)	470	480	490
Tension nominal/Voltage(V)	AC 220-240V 50/60Hz		
Regulable/Dimmable	NO		
CRI	≥80		
Casquillo/Lamp Head	E27		
Angulo/Beam Angle(deg)	140°		
Material	Cristal+PC+Metal/Glass+PC+Metal		
Dimensiones/Dimensions(mm)	Φ45*78		

## LED E27 Bulb

### Características

- \* Voltaje: AC 220-240V 50/60Hz 60mA
- \* 20,000 hrs. vida útil
- \* Encendido instantaneo con potencia total
- \* Perfecta para reemplazar la lampara incandescente de 100W
- \* Baja temperatura al tacto
- \* Libre de mercurio, Libre de emision UV & IR
- \* Esta lampara no es idonea para la iluminacion de acentuacion

### Features

- \* Voltage: AC 220-240V 50/60Hz 60mA
- \* 20,000hrs long life time
- \* Instant start with full bright output flick free
- \* Perfect replacement for 100W incandescent Bulb
- \* Low temperature, safety to touch
- \* No UV or IR emission, mercury FREE
- \* This lamp is not suitable for accent lighting



11W E27 850 Lumen  
Dimmable

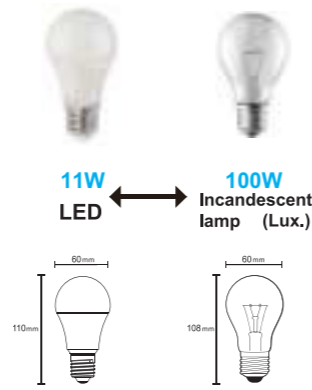

Item No.	R09137
Potencia nominal/Wattage(W)	11
Temperatura de color/CCT(K)	3000K
Flujo luminoso/Luminous Flux(lm)	850
Tension nominal/Voltage(V)	AC 220-240V 50/60Hz
Regulable/Dimmable	YES
CRI	≥80
Casquillo/Lamp Head	E27
Angulo/Beam Angle(deg)	240°
Material	PBT+cristal/glass
Dimensiones/Dimensions(mm)	Φ60*110

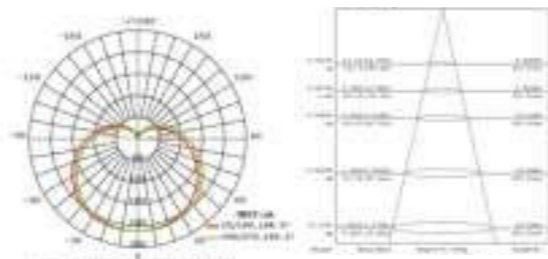

## LED E27 Bulb

### Características

- \* Voltaje: AC 220-240V 50/60Hz 60mA
- \* 25,000 hrs. vida útil
- \* Encendido instantaneo con potencia total
- \* Perfecta para reemplazar la lampara incandescente de 140W
- \* Baja temperatura al tacto
- \* Libre de mercurio, Libre de emision UV & IR
- \* Esta lampara no es idonea para la iluminacion de acentuacion

### Features

- \* Voltage: AC 220-240V 50/60Hz 60mA
- \* 25,000hrs long life time
- \* Instant start with full bright output flick free
- \* Perfect replacement for 140W incandescent Bulb
- \* Low temperature, safety to touch
- \* No UV or IR emission, mercury FREE
- \* This lamp is not suitable for accent lighting



14W E27 1309 Lumen  
G95

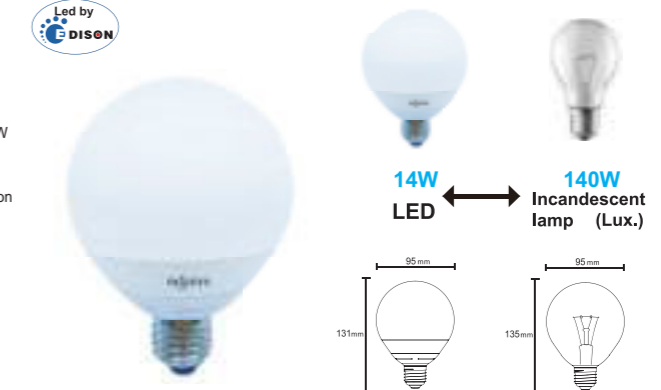

Item No.	R09122	R09123
Potencia nominal/Wattage(W)	14	
Temperatura de color/CCT(K)	3000K	5000K
Flujo luminoso/Luminous Flux(lm)	1259	1309
Tension nominal/Voltage(V)	AC 220-240V 50/60Hz	
Regulable/Dimmable	NO	
CRI	≥80	
Casquillo/Lamp Head	E27	
Angulo/Beam Angle(deg)	180°	
Material	Aluminio+PC/Aluminum+PC	
Dimensiones/Dimensions(mm)	Φ95*131	

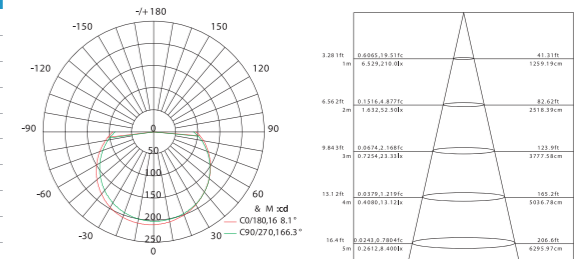

## LED E27 Bulb

### Características

- \* Voltaje: AC 220-240V 50/60Hz 72mA
- \* 15,000 hrs. vida útil
- \* Encendido instantaneo con potencia total
- \* Perfecta para reemplazar la lampara incandescente de 125W
- \* Baja temperatura al tacto
- \* Libre de mercurio, Libre de emision UV & IR
- \* Esta lampara no es idonea para la iluminacion de acentuacion

### Features

- \* Voltage: AC 220-240V 50/60Hz 72mA
- \* 15,000hrs long life time
- \* Instant start with full bright output flick free
- \* Perfect replacement for 125W incandescent Bulb
- \* Low temperature, safety to touch
- \* No UV or IR emission, mercury FREE
- \* This lamp is not suitable for accent lighting



14W E27 1510 Lumen



Item No.	R09139	R09140
Potencia nominal/Wattage(W)	14	
Temperatura de color/CCT(K)	3000K	4000K
Flujo luminoso/Luminous Flux(lm)	1460	1510
Tension nominal/Voltage(V)	AC 220-240V 50/60Hz	
Regulable/Dimmable	NO	
CRI	≥80	
Casquillo/Lamp Head	E27	
Angulo/Beam Angle(deg)	240°	
Material	PBT+cristal/glass	
Dimensiones/Dimensions(mm)	Φ60*120	

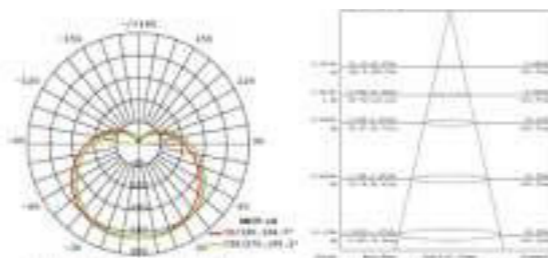

## LED E27 Bulb

### Características

- \* Voltaje: AC 220-240V 50/60Hz 165mA
- \* 15,000 hrs. vida útil
- \* Encendido instantaneo con potencia total
- \* Perfecta para reemplazar la lampara incandescente de 175W
- \* Baja temperatura al tacto
- \* Libre de mercurio, Libre de emision UV & IR
- \* Esta lampara no es idonea para la iluminacion de acentuacion

### Features

- \* Voltage: AC 220-240V 50/60Hz 165mA
- \* 15,000hrs long life time
- \* Instant start with full bright output flick free
- \* Perfect replacement for 175W incandescent Bulb
- \* Low temperature, safety to touch
- \* No UV or IR emission, mercury FREE
- \* This lamp is not suitable for accent lighting



20W E27 2000 Lumen  
G120



Item No.	R09212	R09213
Potencia nominal/Wattage(W)	20	
Temperatura de color/CCT(K)	3000K	4000K
Flujo luminoso/Luminous Flux(lm)	1900	2000
Tension nominal/Voltage(V)	AC 220-240V 50/60Hz	
Regulable/Dimmable	NO	
CRI	≥80	
Casquillo/Lamp Head	E27	
Angulo/Beam Angle(deg)	270°	
Material	Aluminio+Cristal/Aluminum+Glass	
Dimensiones/Dimensions(mm)	Φ120*157	

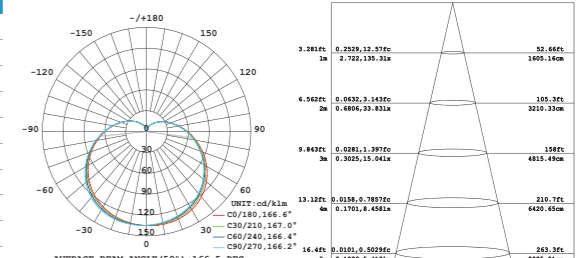

## LED E27 Bulb

### Características

- \* Voltaje: AC 220-240V 50/60Hz 56mA
- \* 15,000 hrs. vida útil
- \* Encendido instantaneo con potencia total
- \* Perfecta para reemplazar la lampara incandescente de 60W
- \* Baja temperatura al tacto
- \* Libre de mercurio, Libre de emision UV & IR
- \* Esta lampara no es idonea para la iluminacion de acentuacion

### Features

- \* Voltage: AC 220-240V 50/60Hz 56mA
- \* 15,000hrs long life time
- \* Instant start with full bright output flick free
- \* Perfect replacement for 60W incandescent Bulb
- \* Low temperature, safety to touch
- \* No UV or IR emission, mercury FREE
- \* This lamp is not suitable for accent lighting



6.5W E27 720 Lumen  
G95

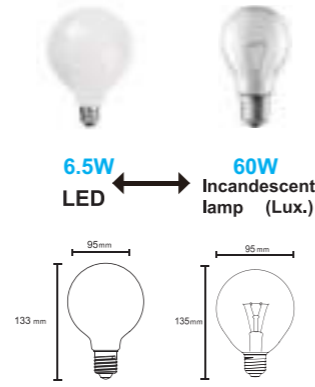

Item No.	R09244	R09245
Potencia nominal/Wattage(W)	6.5	
Temperatura de color/CCT(K)	3000K	4000K
Flujo luminoso/Luminous Flux(lm)	720	740
Tension nominal/Voltage(V)	AC 220-240V 50/60Hz	
Regulable/Dimmable	NO	
CRI	≥80	
Casquillo/Lamp Head	E27	
Angulo/Beam Angle(deg)	360°	
Material	Aluminio+Glass Lens/Aluminum+Glass Lens	
Dimensiones/Dimensions(mm)	Φ95*133	

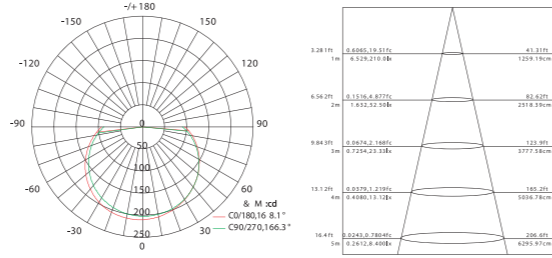

## LED E27 Bulb

### Características

- \* Voltaje: AC 220-240V 50/60Hz 56mA
- \* 15,000 hrs. vida útil
- \* Encendido instantaneo con potencia total
- \* Perfecta para reemplazar la lampara incandescente de 60W
- \* Baja temperatura al tacto
- \* Libre de mercurio, Libre de emision UV & IR
- \* Esta lampara no es idonea para la iluminacion de acentuacion

### Features

- \* Voltage: AC 220-240V 50/60Hz 56mA
- \* 15,000hrs long life time
- \* Instant start with full bright output flick free
- \* Perfect replacement for 60W incandescent Bulb
- \* Low temperature, safety to touch
- \* No UV or IR emission, mercury FREE
- \* This lamp is not suitable for accent lighting



6.5W E27 650 Lumen  
G95

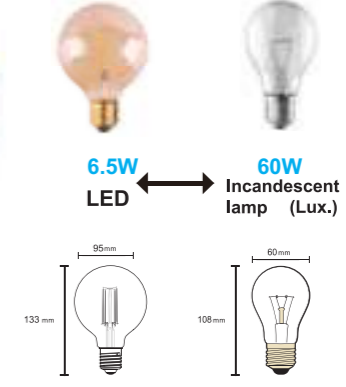

Item No.	R09229
Potencia nominal/Wattage(W)	6.5
Temperatura de color/CCT(K)	2200K
Flujo luminoso/Luminous Flux(lm)	650
Tension nominal/Voltage(V)	AC 220-240V 50/60Hz
Regulable/Dimmable	NO
CRI	≥80
Casquillo/Lamp Head	E27
Angulo/Beam Angle(deg)	360°
Material	Aluminio+Crystal/Aluminum+Glass
Dimensiones/Dimensions(mm)	Φ95*133

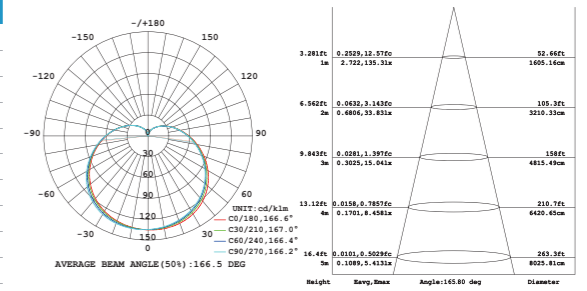

## LED E27 Bulb

### Características

- \* Voltaje: AC 220-240V 50/60Hz 45mA
- \* 15,000 hrs. vida útil
- \* Encendido instantaneo con potencia total
- \* Perfecta para reemplazar la lampara incandescente de 60W
- \* Baja temperatura al tacto
- \* Libre de mercurio, Libre de emision UV & IR
- \* Esta lampara no es idonea para la iluminacion de acentuacion

### Features

- \* Voltage: AC 220-240V 50/60Hz 45mA
- \* 15,000hrs long life time
- \* Instant start with full bright output flick free
- \* Perfect replacement for 60W incandescent Bulb
- \* Low temperature, safety to touch
- \* No UV or IR emission, mercury FREE
- \* This lamp is not suitable for accent lighting



8W E27 720 Lumen  
G95  
Dimmable

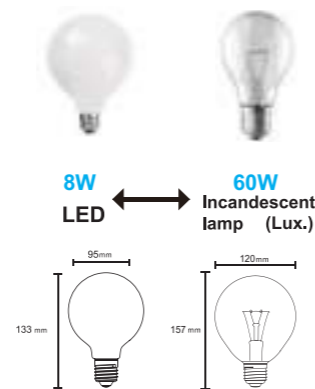

Item No.	R09246
Potencia nominal/Wattage(W)	8
Temperatura de color/CCT(K)	3000K
Flujo luminoso/Luminous Flux(lm)	720
Tension nominal/Voltage(V)	AC 220-240V 50/60Hz
Regulable/Dimmable	YES
CRI	≥80
Casquillo/Lamp Head	E27
Angulo/Beam Angle(deg)	360°
Material	Aluminio+Crystal/Aluminum+Glass
Dimensiones/Dimensions(mm)	Φ95*133

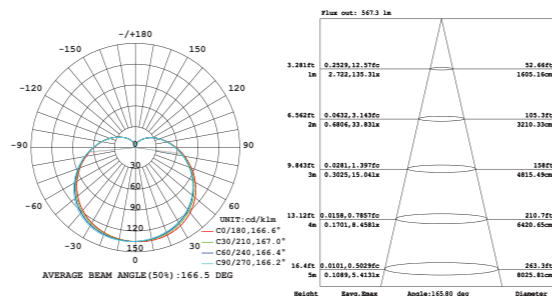

## LED E27 Bulb

### Características

- \* Voltaje: AC 220-240V 50/60Hz 56mA
- \* 15,000 hrs. vida útil
- \* Encendido instantaneo con potencia total
- \* Perfecta para reemplazar la lampara incandescente de 60W
- \* Baja temperatura al tacto
- \* Libre de mercurio, Libre de emision UV & IR
- \* Esta lampara no es idonea para la iluminacion de acentuacion

### Features

- \* Voltage: AC 220-240V 50/60Hz 56mA
- \* 15,000hrs long life time
- \* Instant start with full bright output flick free
- \* Perfect replacement for 60W incandescent Bulb
- \* Low temperature, safety to touch
- \* No UV or IR emission, mercury FREE
- \* This lamp is not suitable for accent lighting



6.5W E27 650 Lumen  
G125

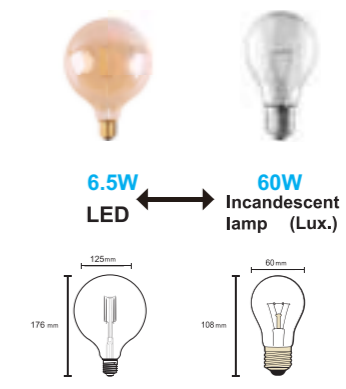

Item No.	R09230
Potencia nominal/Wattage(W)	6.5
Temperatura de color/CCT(K)	2200K
Flujo luminoso/Luminous Flux(lm)	650
Tension nominal/Voltage(V)	AC 220-240V 50/60Hz
Regulable/Dimmable	NO
CRI	≥80
Casquillo/Lamp Head	E27
Angulo/Beam Angle(deg)	360°
Material	Aluminio+Crystal/Aluminum+Glass
Dimensiones/Dimensions(mm)	Φ125*176

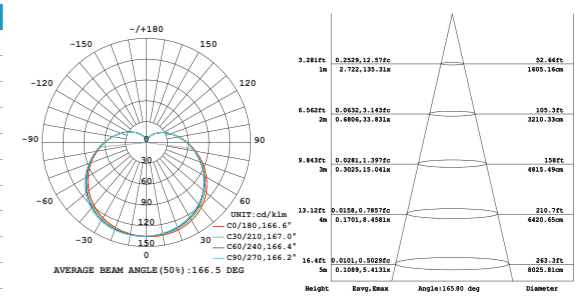

## LED E27 ST64 Bulb

### Características

- \* Voltaje: AC 220-240V 50/60Hz 45mA
- \* 15,000 hrs. vida útil
- \* Encendido instantáneo con potencia total
- \* Perfecta para reemplazar la lámpara incandescente de 60W
- \* Baja temperatura al tacto
- \* Libre de mercurio, Libre de emisión UV & IR
- \* Esta lámpara no es idónea para la iluminación de acentuación

### Features

- \* Voltage: AC 220-240V 50/60Hz 45mA
- \* 15,000hrs long life time
- \* Instant start with full bright output flick free
- \* Perfect replacement for 60W incandescent Bulb
- \* Low temperature, safety to touch
- \* No UV or IR emission, mercury FREE
- \* This lamp is not suitable for accent lighting



8W E27 800 Lumen  
ST64  
Dimmable

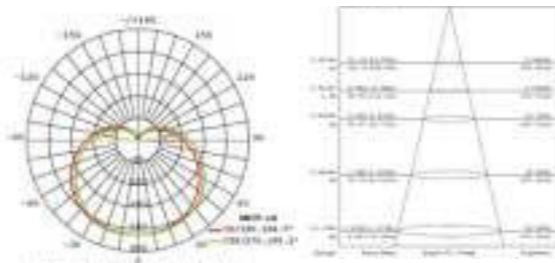
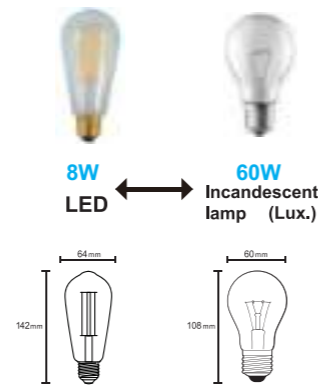

Item No.	R09206
Potencia nominal/Wattage(W)	8
Temperatura de color/CCT(K)	2200K
Flujo luminoso/Luminous Flux(lm)	800
Tension nominal/Voltage(V)	AC 220-240V 50/60Hz
Regulable/Dimmable	YES
CRI	≥80
Casquillo/Lamp Head	E27
Angulo/Beam Angle(deg)	360°
Material	Aluminio+Cristal/Aluminum+Glass
Dimensiones/Dimensions(mm)	Φ64*142

## LED E27 G95 Bulb

### Características

- \* Voltaje: AC 220-240V 50/60Hz 45mA
- \* 15,000 hrs. vida útil
- \* Encendido instantáneo con potencia total
- \* Perfecta para reemplazar la lámpara incandescente de 60W
- \* Baja temperatura al tacto
- \* Libre de mercurio, Libre de emisión UV & IR
- \* Esta lámpara no es idónea para la iluminación de acentuación

### Features

- \* Voltage: AC 220-240V 50/60Hz 45mA
- \* 15,000hrs long life time
- \* Instant start with full bright output flick free
- \* Perfect replacement for 60W incandescent Bulb
- \* Low temperature, safety to touch
- \* No UV or IR emission, mercury FREE
- \* This lamp is not suitable for accent lighting



8W E27 800 Lumen  
G95  
Dimmable

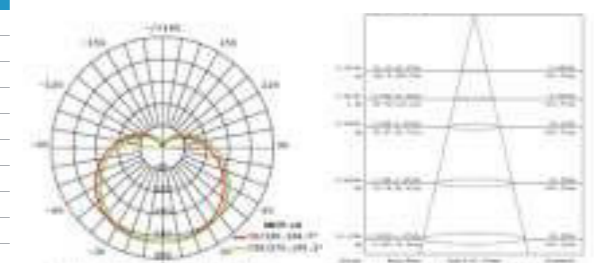
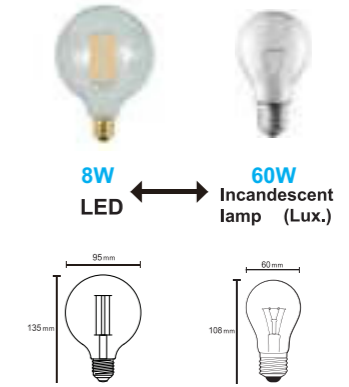

Item No.	R09204
Potencia nominal/Wattage(W)	8
Temperatura de color/CCT(K)	2200K
Flujo luminoso/Luminous Flux(lm)	800
Tension nominal/Voltage(V)	AC 220-240V 50/60Hz
Regulable/Dimmable	YES
CRI	≥80
Casquillo/Lamp Head	E27
Angulo/Beam Angle(deg)	360°
Material	Aluminio+Cristal/Aluminum+Glass
Dimensiones/Dimensions(mm)	Φ95*135

## LED E27 Bulb

### Características

- \* Voltaje: AC 220-240V 50/60Hz 56mA
- \* 15,000 hrs. vida útil
- \* Encendido instantáneo con potencia total
- \* Perfecta para reemplazar la lámpara incandescente de 60W
- \* Baja temperatura al tacto
- \* Libre de mercurio, Libre de emisión UV & IR
- \* Esta lámpara no es idónea para la iluminación de acentuación

### Features

- \* Voltage: AC 220-240V 50/60Hz 56mA
- \* 15,000hrs long life time
- \* Instant start with full bright output flick free
- \* Perfect replacement for 60W incandescent Bulb
- \* Low temperature, safety to touch
- \* No UV or IR emission, mercury FREE
- \* This lamp is not suitable for accent lighting



6.5W E27 650 Lumen  
ST64

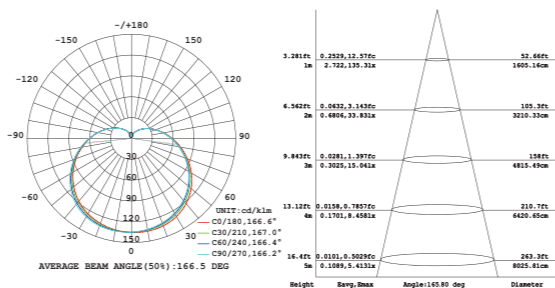
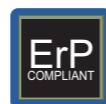

Item No.	R09228
Potencia nominal/Wattage(W)	6.5
Temperatura de color/CCT(K)	2200K
Flujo luminoso/Luminous Flux(lm)	650
Tension nominal/Voltage(V)	AC 220-240V 50/60Hz
Regulable/Dimmable	NO
CRI	≥80
Casquillo/Lamp Head	E27
Angulo/Beam Angle(deg)	360°
Material	Aluminio+Cristal/Aluminum+Glass
Dimensiones/Dimensions(mm)	Φ64*138

## LED E27 G125 Bulb

### Características

- \* Voltaje: AC 220-240V 50/60Hz 45mA
- \* 15,000 hrs. vida útil
- \* Encendido instantáneo con potencia total
- \* Perfecta para reemplazar la lámpara incandescente de 60W
- \* Baja temperatura al tacto
- \* Libre de mercurio, Libre de emisión UV & IR
- \* Esta lámpara no es idónea para la iluminación de acentuación

### Features

- \* Voltage: AC 220-240V 50/60Hz 45mA
- \* 15,000hrs long life time
- \* Instant start with full bright output flick free
- \* Perfect replacement for 60W incandescent Bulb
- \* Low temperature, safety to touch
- \* No UV or IR emission, mercury FREE
- \* This lamp is not suitable for accent lighting



8W E27 800 Lumen  
G125  
Dimmable

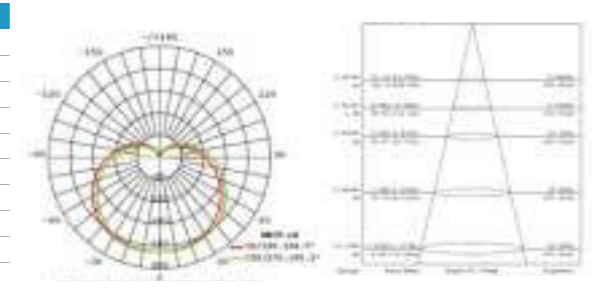
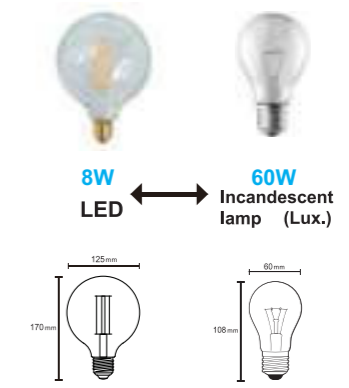

Item No.	R09205
Potencia nominal/Wattage(W)	8
Temperatura de color/CCT(K)	2200K
Flujo luminoso/Luminous Flux(lm)	800
Tension nominal/Voltage(V)	AC 220-240V 50/60Hz
Regulable/Dimmable	YES
CRI	≥80
Casquillo/Lamp Head	E27
Angulo/Beam Angle(deg)	360°
Material	Aluminio+Cristal/Aluminum+Glass
Dimensiones/Dimensions(mm)	Φ125*170



## LED E27 T30 Bulb

### Características

- \* Voltaje: AC 220-240V 50/60Hz 430mA
- \* 20,000 hrs. vida útil
- \* Encendido instantáneo con potencia total
- \* Perfecta para reemplazar la lámpara incandescente de 55W
- \* Baja temperatura al tacto
- \* Libre de mercurio, Libre de emisión UV & IR
- \* Esta lámpara no es idónea para la iluminación de acentuación

### Features

- \* Voltage: AC 220-240V 50/60Hz 430mA
- \* 20,000hrs long life time
- \* Instant start with full bright output flick free
- \* Perfect replacement for 55W incandescent Bulb
- \* Low temperature, safety to touch
- \* No UV or IR emission, mercury FREE
- \* This lamp is not suitable for accent lighting



6W E27 575 Lumen  
T30

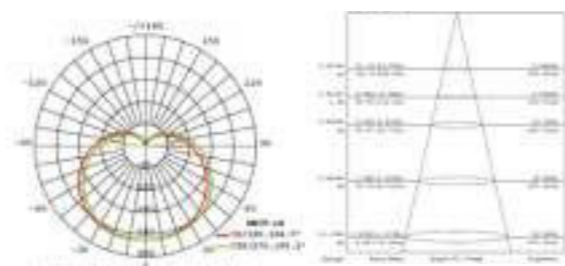
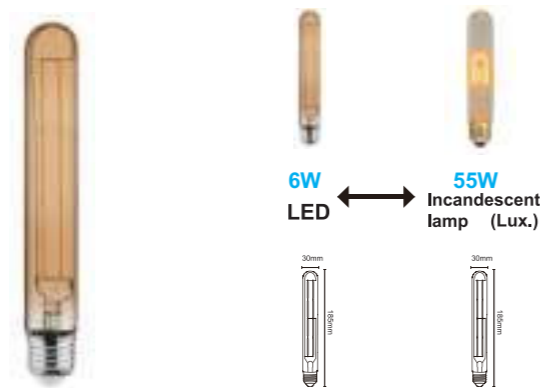
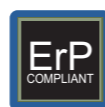

Item No.	R09233
Potencia nominal/Wattage(W)	6
Temperatura de color/CCT(K)	2400K
Flujo luminoso/Luminous Flux(lm)	575
Tension nominal/Voltage(V)	AC 220-240V 50/60Hz
Regulable/Dimmable	NO
CRI	≥80
Casquillo/Lamp Head	E27
Angulo/Beam Angle(deg)	360°
Material	Aluminio+Cristal/Aluminum+Glass
Dimensiones/Dimensions(mm)	Φ30*185

## LED GX53 Bulb

### Características

- \* Voltaje: AC 100-250V 50/60Hz 80mA
- \* 20,000 hrs. vida útil
- \* Encendido instantáneo con potencia total
- \* Perfecta para reemplazar la lámpara incandescente de 80W
- \* Baja temperatura al tacto
- \* Libre de mercurio, Libre de emisión UV & IR
- \* Esta lámpara no es idónea para la iluminación de acentuación

### Features

- \* Voltage: AC 100-250V 50/60Hz 80mA
- \* 20,000hrs long life time
- \* Instant start with full bright output flick free
- \* Perfect replacement for 80W incandescent Bulb
- \* Low temperature, safety to touch
- \* No UV or IR emission, mercury FREE
- \* This lamp is not suitable for accent lighting



9W GX53 730 Lumen

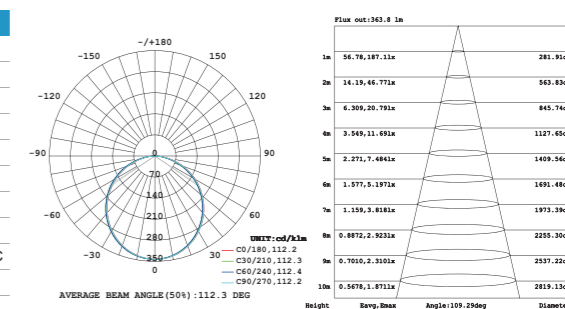
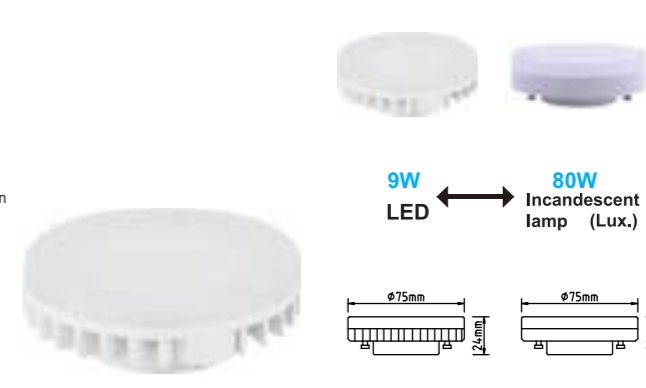

Item No.	R09224	R09225
Potencia nominal/Wattage(W)	9	
Temperatura de color/CCT(K)	3000K	4000K
Flujo luminoso/Luminous Flux(lm)	730	740
Tension nominal/Voltage(V)	AC 100-250V 50/60Hz	
Regulable/Dimmable	NO	
CRI	≥80	
Casquillo/Lamp Head	GX53	
Angulo/Beam Angle(deg)	120°	
Material	estampacion de aluminio&PC / Stamping aluminium&PC	
Dimensiones/Dimensions(mm)	Φ75*24	

## LED E27 T30 Bulb

### Características

- \* Voltaje: AC 220-240V 50/60Hz 430mA
- \* 20,000 hrs. vida útil
- \* Encendido instantáneo con potencia total
- \* Perfecta para reemplazar la lámpara incandescente de 70W
- \* Baja temperatura al tacto
- \* Libre de mercurio, Libre de emisión UV & IR
- \* Esta lámpara no es idónea para la iluminación de acentuación

### Features

- \* Voltage: AC 220-240V 50/60Hz 430mA
- \* 20,000hrs long life time
- \* Instant start with full bright output flick free
- \* Perfect replacement for 70W incandescent Bulb
- \* Low temperature, safety to touch
- \* No UV or IR emission, mercury FREE
- \* This lamp is not suitable for accent lighting



7W E27 660 Lumen  
T30

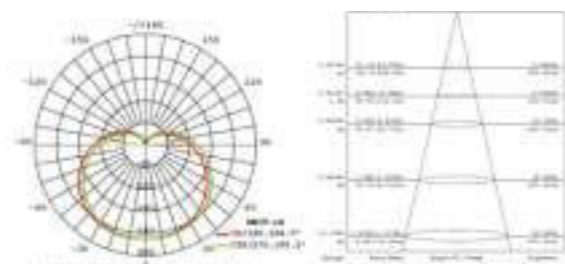
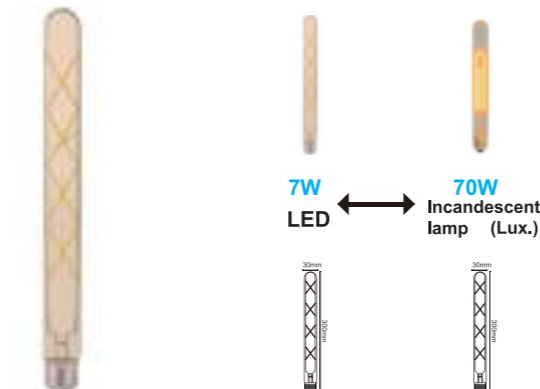

Item No.	R09232
Potencia nominal/Wattage(W)	7
Temperatura de color/CCT(K)	2400K
Flujo luminoso/Luminous Flux(lm)	660
Tension nominal/Voltage(V)	AC 220-240V 50/60Hz
Regulable/Dimmable	NO
CRI	≥80
Casquillo/Lamp Head	E27
Angulo/Beam Angle(deg)	360°
Material	Aluminio+Cristal/Aluminum+Glass
Dimensiones/Dimensions(mm)	Φ30*300

## LED GX53 Bulb

### Características

- \* Voltaje: AC 100-250V 50/60Hz 104mA
- \* 20,000 hrs. vida útil
- \* Encendido instantáneo con potencia total
- \* Perfecta para reemplazar la lámpara incandescente de 100W
- \* Baja temperatura al tacto
- \* Libre de mercurio, Libre de emisión UV & IR
- \* Esta lámpara no es idónea para la iluminación de acentuación

### Features

- \* Voltage: AC 100-250V 50/60Hz 104mA
- \* 20,000hrs long life time
- \* Instant start with full bright output flick free
- \* Perfect replacement for 100W incandescent Bulb
- \* Low temperature, safety to touch
- \* No UV or IR emission, mercury FREE
- \* This lamp is not suitable for accent lighting



12W GX53 930 Lumen

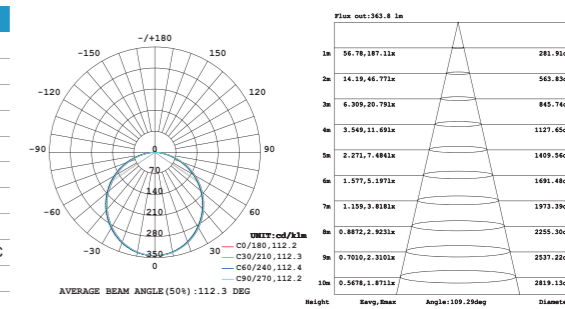
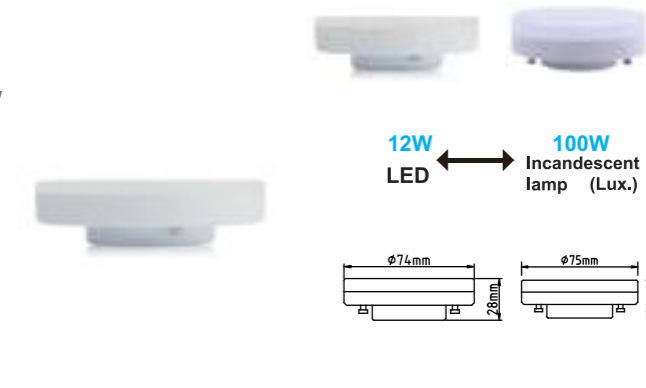

Item No.	R09248	R09249
Potencia nominal/Wattage(W)	12	
Temperatura de color/CCT(K)	3000K	4000K
Flujo luminoso/Luminous Flux(lm)	930	960
Tension nominal/Voltage(V)	AC 100-250V 50/60Hz	
Regulable/Dimmable	NO	
CRI	≥80	
Casquillo/Lamp Head	GX53	
Angulo/Beam Angle(deg)	120°	
Material	estampacion de aluminio&PC / Stamping aluminium&PC	
Dimensiones/Dimensions(mm)	Φ74*28	

REFERENCIA	FAMILIA	PAGE																		
			6072	TARIFA	82	6397	GRACIOSA	242	6526	TRIAX	332	6631	SAONA SUP	124	6811	COMFORT IP	259			
1326	FLAME	404	6075	P R E A	84	6398	MEDANO	236	6527	DAVOS	324	6632	SAONA SUP	124	6812	COMFORT IP	259			
1388	AVORIAZ	428	6076	P R E A	84	6399	MEDANO	236	6530	SOCHI	334	6633	SAONA SUP	124	6813	COMFORT IP	259			
1391	AVORIAZ	428	6077	P R E A	84	6400	GARDA	226	6531	SOCHI	334	6634	SAONA SUP	124	6820	GOKOVA	80			
1394	AVORIAZ	428	6080	CAYMAN	74	6401	GARDA	226	6534	BORA	336	6635	SAONA SUP	124	6821	GOKOVA	80			
1397	AVORIAZ	384	6081	CAYMAN	74	6402	GARDA	226	6535	BORA	336	6700	TORCH	66	6825	TORCH	158			
1398	AVORIAZ	384	6082	CAYMAN	74	6403	GARDA	226	6536	BORA	336	6701	TORCH	66	6826	TORCH	158			
1399	AVORIAZ	384	6083	CAYMAN	74	6405	ATLANTIS	258	6537	BORA	336	6702	TORCH	68	6827	TORCH	116			
1400	FLAME	432	6091	CAICOS	86	6406	ATLANTIS	258	6538	BORA	336	6703	TORCH	68	6828	TORCH	116			
5120	TOJA	98	6092	CAICOS	86	6470	RODAS	356	6539	BORA	336	6710	SAL	186	6830	GOWER	188			
5121	TOJA	98	6093	CAICOS	86	6480	K2	396	6540	ARCS	298	6711	SAL	186	6831	GOWER	188			
5410	ZERO E27	120	6211	KINKÉ	378	6481	K2	396	6541	ARCS	298	6712	SAL	186	6832	GOWER	188			
5411	ZERO E27	120	6212	KINKÉ	376	6482	VOLCANO	314	6542	JACKSON	354	6713	SAL	72/186	6833	GOWER	188			
5622	ARUBA	160	6213	KINKÉ	380	6483	VOLCANO	314	6543	JACKSON	354	6714	SAL	72	6835	LAMBORJINI	253			
5623	ARUBA	160	6214	KINKÉ	380	6484	K2	396	6545	ESPIGA	430	6715	ZANZIBAR	172	6837	LAMBORJINI	253			
5624	ARUBA	160	6215	KINKÉ	380	6490	MERIBEL	408	6546	ESPIGA	430	6716	ZANZIBAR	172	6838	LAMBORJINI	253			
5625	ARUBA	160	6218	KINKÉ	380	6491	ASTUN	402	6547	ESPIGA	430	6717	SAL	210	6839	LAMBORJINI	252			
5626	ARUBA	192	6220	ASIMETRIC	56	6492	MERIBEL	310	6550	MAYA	410	6718	SAL	210	6840	LAMBORJINI	252			
5627	ARUBA	192	6221	ASIMETRIC	56	6493	MERIBEL	310	6551	MAYA	304	6735	TORCH	178	6841	LAMBORJINI	252			
5628	ARUBA	192	6222	ASIMETRIC	56	6494	MERIBEL	308	6552	MAYA	304	6736	TORCH	178	6842	LAMBORJINI	252			
5629	ARUBA	192	6230	MURAL	94	6495	MERIBEL	308	6553	MAYA	362	6737	TORCH	168	6843	LAMBORJINI	252			
5632	KAILUA	196	6253	TOJA	98	6496	CERLER	357	6554	MAYA	362	6738	TORCH	168	6844	LAMBORJINI	252			
5633	KAILUA	196	6254	TOJA	98	6497	TIGNES	357	6555	MAYA	382	6750	ZANZIBAR	58	6845	LAMBORJINI	252			
5714	CABARETE	77	6280	SAL	186	6498	TIGNES	422	6558	IGUAZU	316	6751	ZANZIBAR	62	6846	LAMBORJINI	252			
5715	CABARETE	76	6281	SAL	186	6499	TIGNES	422	6559	IGUAZU	316	6752	ZANZIBAR	58	6850	CYCLE	300			
5717	BORACAY	198	6282	SAL	186	6508	TEJA	312	6560	MURAL	118	6753	ZANZIBAR	62	6851	CYCLE	300			
5718	BORACAY	198	6283	SAL	72/186	6510	KANDANCHU	322	6561	MURAL	118	6754	ZANZIBAR	60	6855	GUINCHO	222			
6015	ARUBA	190	6284	SAL	72	6511	KANDANCHU	322	6562	MURAL	171	6755	ZANZIBAR	60	6856	GUINCHO	222			
6016	ARUBA	190	6370	JERI	102	6512	KANDANCHU	323	6563	MURAL	181	6760	MORNE	54	6857	GUINCHO	222			
6043	PETACA	108	6374	JERI	102	6513	KANDANCHU	323	6620	SAONA SUP	122	6761	MORNE	54	6858	GUINCHO	222			
6044	ARUBA	208	6380	PARACURU	100	6514	KANDANCHU	322	6621	SAONA SUP	122	6762	MORNE	54	6859	GUINCHO	222			
6045	ARUBA	208	6381	PARACURU	100	6515	KANDANCHU	322	6622	SAONA SUP	122	6763	MORNE	54	6860	GUINCHO	222			
6046	BOAVISTA	78	6382	PARACURU	100	6516	KANDANCHU	323	6623	SAONA SUP	122	6768	IGUAZU	318	6861	GUINCHO	222			
6047	BOAVISTA	78	6383	PARACURU	100	6517	KANDANCHU	323	6624	SAONA SUP	122	6769	IGUAZU	318	6862	GUINCHO	222			
6048	BOAVISTA	79	6384	PARACURU	100	6520	DAVOS	324	6625	SAONA SUP	122	6770	RUKA	306	6865	FUERTEVENTURA	64			
6049	BOAVISTA	79	6385	PARACURU	100	6521	DAVOS	324	6626	SAONA SUP	122	6771	RUKA	412	6866	FUERTEVENTURA	64			
6050	BOAVISTA	79	6390	GRACIOSA	243	6522	DAVOS	324	6627	SAONA SUP	122	6772	RUKA	412	6870	TENERIFE	104			
6051	BOAVISTA	79	6392	GRACIOSA	242	6523	DAVOS	324	6628	SAONA SUP	124	6773	RUKA	412	6871	TENERIFE	104			
6070	TARIFA	82	6395	MEDANO	236	6524	DAVOS	324	6629	SAONA SUP	124	6774	RUKA	306	6875	LANZAROTE	106			
6071	TARIFA	82	6396	MEDANO	236	6525	TRIAX	332	6630	SAONA SUP	124	6810	COMFORT IP	259	6876	LANZAROTE	106			

6900	BRANDON	250	7062	CHAMONIX	348	7183	LEVI	352	7297	ERIS	42	7377	DRIVER TIRAS LED STRIPS	277	7411	PERFILES LED PROFILES	274
6901	BRANDON	250	7063	CHAMONIX	348	7184	LEVI	370	7298	ERIS	44	7378	DRIVER TIRAS LED STRIPS	275	7412	PERFILES LED PROFILES	274
6902	BRANDON	250	7065	VERBIER	364	7185	LEVI	370	7299	ERIS	44	7379	DRIVER TIRAS LED STRIPS	275	7413	PERFILES LED PROFILES	274
6903	BRANDON	250	7066	VERBIER	364	7186	LEVI	371	7300	ERIS	46	7380	DRIVER TIRAS LED STRIPS	275	7414	PERFILES LED PROFILES	274
6905	ASTUN	402	7070	SOLDEN	345	7187	LEVI	371	7301	ERIS	46	7381	PERFILES LED PROFILES	264	7415	PERFILES LED PROFILES	274
6906	ASTUN	402	7071	SOLDEN	345	7197	DURBAN	52	7305	ORION	144	7382	PERFILES LED PROFILES	264	7416	PERFILES LED PROFILES	274
6907	ASTUN	402	7072	SOLDEN	344	7198	DURBAN	52	7306	ORION	146	7383	PERFILES LED PROFILES	264	7417	PERFILES LED PROFILES	268
7011	BAKER	434	7073	SOLDEN	344	7199	DURBAN	52	7307	ORION	148	7384	PERFILES LED PROFILES	264	7418	PERFILES LED PROFILES	268
7012	BAKER	434	7080	GUINCHO	222	7200	FIJI	212	7308	ORION	146	7385	PERFILES LED PROFILES	264	7419	PERFILES LED PROFILES	268
7013	BAKER	436	7081	GUINCHO	222	7201	FIJI	212	7310	SIRIO	154	7386	PERFILES LED PROFILES	264	7420	URANO	285
7014	BAKER	436	7082	GUINCHO	222	7202	FIJI	212	7311	SIRIO	156	7387	PERFILES LED PROFILES	264	7421	URANO	285
7015	BAKER	434	7083	GUINCHO	222	7203	FIJI	212	7312	SIRIO	150	7388	PERFILES LED PROFILES	264	7422	URANO	285
7016	BAKER	434	7085	MERIBEL	406	7204	FIJI	212	7313	SIRIO	153	7389	PERFILES LED PROFILES	264	7423	URANO	287
7017	BAKER	436	7086	MERIBEL	340	7205	FIJI	212	7315	IPSILON	200	7390	PERFILES LED PROFILES	264	7424	URANO	287
7018	BAKER	436	7088	CHEVALIER	414	7206	FIJI	212	7316	IPSILON	200	7391	PERFILES LED PROFILES	264	7425	URANO	287
7021	ASPEN	438	7090	SAPPPORO	400	7207	FIJI	212	7317	IPSILON	202	7392	PERFILES LED PROFILES	265	7426	URANO	289
7022	ASPEN	438	7091	SAPPPORO	400	7208	FIJI	214	7318	IPSILON	202	7393	PERFILES LED PROFILES	265	7427	URANO	289
7023	ASPEN	438	7092	SAPPPORO	400	7209	FIJI	214	7319	IPSILON	200	7394	PERFILES LED PROFILES	265	7428	URANO	289
7024	ASPEN	438	7093	SAPPPORO	400	7210	FIJI	214	7320	IPSILON	200	7395	PERFILES LED PROFILES	265	7429	URANO	291
7025	ASPEN	438	7098	YETI	342	7211	FIJI	214	7321	IPSILON	200	7396	PERFILES LED PROFILES	265	7430	URANO	291
7026	ASPEN	438	7100	K2	398	7212	FIJI	214	7322	IPSILON	200	7397	PERFILES LED PROFILES	265	7431	URANO	291
7027	ASPEN	440	7101	K2	398	7213	FIJI	214	7360	TIRAS LED STRIPS	261	7398	PERFILES LED PROFILES	265	7435	DAVOS XL	328
7028	ASPEN	440	7105	TAOS	420	7214	FIJI	214	7361	TIRAS LED STRIPS	261	7399	PERFILES LED PROFILES	265	7436	DAVOS XL	328
7029	ASPEN	440	7106	TAOS	420	7215	FIJI	214	7362	TIRAS LED STRIPS	261	7400	PERFILES LED PROFILES	265	7437	DAVOS XL	328
7030	ASPEN	440	7107	TAOS	426	7216	FIJI	212	7363	TIRAS LED STRIPS	262	7401	PERFILES LED PROFILES	265	7438	DAVOS XL	328
7031	ASPEN	440	7108	TAOS	350	7217	FIJI	212	7364	TIRAS LED STRIPS	262	7402	PERFILES LED PROFILES	265	7451	NEPTUNO	228
7032	ASPEN	440	7109	TAOS	350	7218	FIJI	212	7365	TIRAS LED STRIPS	262	7403	TIRAS LED STRIPS	263	7452	NEPTUNO	228
7037	KANDANCHU	322	7110	COOK	110	7219	FIJI	212	7366	TIRAS LED STRIPS	260	7404	TIRAS LED STRIPS	263	7453	NEPTUNO	228
7038	KANDANCHU	322	7111	COOK	110	7220	FIJI	212	7367	TIRAS LED STRIPS	260	7405	TIRAS LED STRIPS	263	7454	NEPTUNO	228
7039	KANDANCHU	323	7115	K3	394	7221	FIJI	212	7368	TIRAS LED STRIPS	260	7406	TIRAS LED STRIPS	263	7460	MURAL	94
7040	KANDANCHU	323	7116	K3	394	7222	FIJI	212	7369	TIRAS LED STRIPS	263	7407	PERFILES LED PROFILES	274	7462	MURAL	118
7045	ALPINE	346	7130	POLINESIA	374	7223	FIJI	212	7370	TIRAS LED STRIPS	263	7408	PERFILES LED PROFILES	274	7463	MURAL	118
7046	ALPINE	346	7131	POLINESIA	372	7224	FIJI	212	7371	DRIVER TIRAS LED STRIPS	276	7409	PERFILES LED PROFILES	274	7464	MURAL	170
7050	UTAH	338	7133	POLINESIA	302	7240	POLAR	48	7372	DRIVER TIRAS LED STRIPS	276	7410	PERFILES LED PROFILES	274	7465	MURAL	180
7051	UTAH	338	7175	DURBAN	50	7241	POLAR	48	7373	DRIVER TIRAS LED STRIPS	276	7407	PERFILES LED PROFILES	274	7470	KANDANCHU	320
7052	UTAH	338	7176	DURBAN	50	7292	VENUS	40	7374	DRIVER TIRAS LED STRIPS	276	7408	PERFILES LED PROFILES	274	7471	KANDANCHU	320
7055	BACHELOR	368	7177	DURBAN	50	7293	VENUS	40	7375	DRIVER TIRAS LED STRIPS	276	7409	PERFILES LED PROFILES	274	7472	KANDANCHU	320
7056	BACHELOR	368	7180	LEVI	353	7294	IOS	184	7376	DRIVER TIRAS LED STRIPS	277	7410	PERFILES LED PROFILES	274	7473	KANDANCHU	320
7060	CHAMONIX	366	7181	LEVI	353	7295	IOS	184									
7061	CHAMONIX	366	7182	LEVI	352	7296	ERIS	42									

7475	ORION	140	7556	HANOK	134	7742	BASICO GUIo	246
7476	ORION	142	7557	HANOK	134	7743	BASICO GUIo	246
7480	MORNE	54	7558	HANOK	134	7760	KUBICK	30
7481	MORNE	54	7559	HANOK	134	7761	KUBICK	30
7482	MORNE	54	7569	HANOK	128	7762	KUBICK	30
7483	MORNE	54	7590	KUBICK	30	7763	KUBICK	30
7484	MORNE	54	7591	KUBICK	30	7770	HANOK	26
7510	EYES	166	7592	KUBICK	30	7771	HANOK	26
7511	EYES	166	7593	KUBICK	30	7772	HANOK	26
7512	EYES	176	7594	KUBICK	30	7773	HANOK	26
7513	EYES	36	7595	KUBICK	30	7774	HANOK	24
7514	EYES	36	7596	KUBICK	30	7775	HANOK	24
7515	SAL	164	7597	KUBICK	30	7776	HANOK	24
7516	SAL	164	7640	BAKER	434	7777	HANOK	24
7517	SAL	174	7641	BAKER	436	7778	HANOK	24
7518	SAL	70	7642	BAKER	434	7780	PAGODA	206
7519	SAL	70	7643	BAKER	436	7781	PAGODA	206
7520	SAL	164	7645	DAVOS	326	7782	PAGODA	206
7521	SAL	164	7646	DAVOS	326	7783	PAGODA	206
7522	SAL	174	7647	DAVOS	326	7784	PAGODA	136
7523	SAL	70	7648	DAVOS	326	7785	PAGODA	136
7524	SAL	70	7649	DAVOS	326	7786	PAGODA	136
7535	GUINCHO GUIo	224	7650	DAVOS	326	7787	PAGODA	136
7536	GUINCHO GUIo	224	7651	DAVOS XL	328	7788	PAGODA	204
7540	HANOK	130	7652	DAVOS XL	328	7789	PAGODA	204
7541	HANOK	130	7653	DAVOS XL	328	7790	PAGODA	138
7542	HANOK	128	7654	DAVOS XL	328	7791	PAGODA	138
7543	HANOK	128	7693	LUPPI	28	7813	ARCS	298
7544	HANOK	130	7694	LUPPI	28	7814	ARCS	298
7545	HANOK	130	7695	LUPPI	28	7815	DAVOS DOUBLE	330
7546	HANOK	128	7720	GOA	34	7816	DAVOS DOUBLE	330
7547	HANOK	128	7721	GOA	34	7817	DAVOS DOUBLE	330
7548	HANOK	132	7730	GLACIAR	182	7818	DAVOS DOUBLE	330
7549	HANOK	132	7731	GLACIAR	182	7819	DAVOS DOUBLE	330
7550	HANOK	132	7732	GLACIAR	182	7820	DAVOS DOUBLE	330
7551	HANOK	132	7733	GLACIAR	182	7821	DAVOS DOUBLE	330
7552	HANOK	132	7734	GLACIAR	182	7822	DAVOS DOUBLE	330
7553	HANOK	132	7735	GLACIAR	182	7823	CAYMAN	74
7554	HANOK	134	7740	BASICO GUIo	246	7824	CAYMAN	74
7555	HANOK	134	7741	BASICO GUIo	246	7825	CAYMAN	74

7826	CAYMAN	74	7855	RECESSED BASES EMPOTRAR	162	7900	KANDANCHU	358
7827	NEPTUNO	228	7856	RECESSED BASES EMPOTRAR	162	7901	KANDANCHU	358
7828	NEPTUNO	228	7857	RECESSED BASES EMPOTRAR	162	7902	KANDANCHU	358
7829	GARDA	226	7858	RECESSED BASES EMPOTRAR	162	7903	KANDANCHU	358
7830	GARDA	226	7859	RECESSED BASES EMPOTRAR	162	7904	KANDANCHU	359
7831	GARDA	226	7900	KANDANCHU	358	7905	KANDANCHU	359
7832	GARDA	226	7901	KANDANCHU	358	7906	KANDANCHU	359
7833	GARDA	226	7902	KANDANCHU	358	7907	KANDANCHU	359
7834	GARDA	226	7903	KANDANCHU	358	7908	VOLCANO	360
7840	MURAL	94	7904	KANDANCHU	359	7910	TOBAGO	22
7841	MURAL	94	7905	KANDANCHU	359	7911	TOBAGO	22
7853	CAYMAN	74	7906	KANDANCHU	359	7912	TOBAGO	22
7854	CAYMAN	74	7907	KANDANCHU	359	7913	TOBAGO	22
7855	RECESSED BASES EMPOTRAR	162	7908	VOLCANO	360	7914	TOBAGO	22
7856	RECESSED BASES EMPOTRAR	162	7910	TOBAGO	22	7915	TOBAGO	22
7857	RECESSED BASES EMPOTRAR	162	7911	TOBAGO	22	7928	BERET	297
7858	RECESSED BASES EMPOTRAR	162	7912	TOBAGO	22	7929	BERET	296
7859	RECESSED BASES EMPOTRAR	162	7913	TOBAGO	22	7930	RELAX	386
7900	KANDANCHU	358	7914	TOBAGO	22	7931	RELAX	386
7901	KANDANCHU	358	7915	TOBAGO	22	7932	RELAX	386
7902	KANDANCHU	358	7928	BERET	297	7933	RELAX	388
7903	KANDANCHU	358	7929	BERET	296	7934	RELAX	388

7935	RELAX	388	7961	SAL	114	8060	PERFILES LED PROFILES	268
7936	IOS	126	7962	SAL	114	8061	PERFILES LED PROFILES	268
7937	IOS	126	7985	K4	392	8062	PERFILES LED PROFILES	268
7945	HANOK	112	7986	K4	392	8063	PERFILES LED PROFILES	268
7946	HANOK	112	7987	K4	392	8064	PERFILES LED PROFILES	266
7947	HANOK	112	7988	K5	390	8065	PERFILES LED PROFILES	266
7948	HANOK	112	7989	K5	390	8066	PERFILES LED PROFILES	266
7949	HANOK	112	7990	LOTUS	294			
7950	HANOK	112	7991	LOTUS	294			
7951	HANOK	112	7992	LOTUS	294			
7952	HANOK	112	7993	LOTUS	294			
7953	HANOK	112	7994	LOTUS	294			
7961	SAL	114	7995	LOTUS	294			
7962	SAL	114	7996	LOTUS	294			
7985	K4	392	7997	LOTUS	294			
7986	K4	392	8010	VENUS	38			
7987	K4	392	8011	VENUS	38			
7988	K5	390	8012	VENUS	38			
7989	K5	390	8013	VENUS	38			
7990	LOTUS	294	8034	VENUS	38			
7991	LOTUS	294	8035	VENUS	38			
7992	LOTUS	294						
7993	LOTUS	294						
7994	LOTUS	294						
7995	LOTUS	294						
7996	LOTUS	294						
7997	LOTUS	294						
8010	VENUS	38						
8011	VENUS	38						
8012	VENUS	38						
8013	VENUS	38						
8034	VENUS	38						
8035	VENUS	38						
8060	PERFILES LED PROFILES	268						
8061	PERFILES LED PROFILES	268						
8062	PERFILES LED PROFILES	268						
8063	PERFILES LED PROFILES	268						
8064	PERFILES LED PROFILES	266						
8065	PERFILES LED PROFILES	266						
8066	PERFILES LED PROFILES	266						

8067	PERFILES LED PROFILES	272	8122	ORION	16
8068	PERFILES LED PROFILES	272	8123	ORION	16
8069	PERFILES LED PROFILES	272	8124	ORION	16
8070	PERFILES LED PROFILES	270	8125	ORION	16
8071	PERFILES LED PROFILES	270	8126	ORION	16
8072	PERFILES LED PROFILES	270	8127	ORION	16
8087	TAHITIXL	18	8128	ORION	16
8088	TAHITIXL	18	8129	ORION	16
8089	TAHITIXL	18	8130	ORION	16
8090	TAHITIXL	18	8151	ALPINE	416
8091	ALTEA	20	8152	ANDES	292
8092	ALTEA	20	8153	ANDES	292
8093	ALTEA	20	8154	ANDES	292
8094	ALTEA	20	8155	QUEBEC	424
8095	ALTEA	20	8156	FUJI	14
8096	ALTEA	20	8157	FUJI	14
8097	ALTEA	20	8158	FUJI	14
8098	ALTEA	20	8159	FUJI	14
8108	CHICAGO	418	9953074	SISTEMAS TIRAS STRIPS	283
8109	CHICAGO	418	9955901	SISTEMAS TIRAS STRIPS	280

9955905	SISTEMAS TIRAS STRIPS	281
9955911	SISTEMAS TIRAS STRIPS	278
9955912	SISTEMAS TIRAS STRIPS	279
9955921	SISTEMAS TIRAS STRIPS	282
C0001	BASICO GU10	244
C0002	BASICO GU10	244
C0003	BASICO GU10	244
C0004	BASICO GU10	244
C0005	BASICO GU10	244
C0006	BASICO GU10	244
C0007	BASICO GU10	244
C0008	BASICO GU10	244
C0041	CABRERA	234
C0042	CABRERA	234
C0043	CABRERA	234
C0044	CABRERA	234
C0047	CABRERA	234
C0048	CABRERA	234
C0049	CABRERA	234
C0050	CABRERA	234
C0071	FORMENTERA	230
C0072	FORMENTERA	230
C0073	FORMENTERA	230
C0074	FORMENTERA	230
C0075	FORMENTERA	231
C0076	FORMENTERA	231
C0077	FORMENTERA	231
C0078	FORMENTERA	231
C0079	FORMENTERA	231
C0080	FORMENTERA	231
C0081	CIES	256
C0082	CIES	256
C0083	METACRILATO	254
C0084	METACRILATO	254
C0085	COLUMBRETES	195
C0086	COLUMBRETES	195
C0087	COLUMBRETES	194
C0089	TAHITI	96
C0101	BORA BORA	88
C0102	BORA BORA	88

C0103	BORA BORA	92
C0104	BORA BORA	92
C0111	BORA BORA	88
C0112	BORA BORA	88
C0113	BORA BORA	92
C0114	BORA BORA	92
C0115	BORA BORA	92
C0116	BORA BORA	92
C0117	BORA BORA	90
C0118	BORA BORA	90
C0119	BORA BORA	88
C0120	BORA BORA	88
C0124	BORA BORA	90
C0125	BORA BORA	90
C0126	BORA BORA	90
C0127	BORA BORA	88
C0128	BORA BORA	88
C0129	BORA BORA	90
C0130	BORA BORA	90
C0131	BORA BORA	88
C0132	BORA BORA	88
C0133	BORA BORA	90
C0134	BORA BORA	90
C0160	COMFORT GU10	248
C0161	COMFORT GU10	248
C0162	COMFORT GU10	248
C0163	COMFORT GU10	248
C0164	COMFORT GU10	248
C0165	COMFORT GU10	248
C0180	SAONA	238
C0181	SAONA	238
C0182	SAONA	239
C0183	SAONA	239
C0184	SAONA	238
C0185	SAONA	238
C0186	SAONA	239
C0187	SAONA	239
C0190	SAONA	240
C0191	SAONA	240
C0192	SAONA	241

C0193	SAONA	241
C0194	SAONA	240
C0195	SAONA	240
C0196	SAONA	241
C0197	SAONA	241
R09114	BOMBILLA BULB E14	452
R09115	BOMBILLA BULB E14	451
R09116	BOMBILLA BULB E14	452
R09117	BOMBILLA BULB E14	453
R09118	BOMBILLA BULB E14	453
R09122	BOMBILLA BULB E27	459
R09123	BOMBILLA BULB E27	459
R09131	BOMBILLA BULB E27	456
R09132	BOMBILLA BULB E27	456
R09133	BOMBILLA BULB E27	455
R09134	BOMBILLA BULB E27	455
R09135	BOMBILLA BULB E27	457
R09136	BOMBILLA BULB E27	457
R09137	BOMBILLA BULB E27	458
R09139	BOMBILLA BULB E27	458
R09140	BOMBILLA BULB E27	458
R09156	BOMBILLA BULB GU10	448
R09157	BOMBILLA BULB GU10	448
R09158	BOMBILLA BULB GU10	448
R09159	BOMBILLA BULB GU10	448
R09182	BOMBILLA BULB G9	445
R09184	BOMBILLA BULB G9	444
R09185	BOMBILLA BULB G9	444
R09194	BOMBILLA BULB GU10	449
R09195	BOMBILLA BULB GU10	449
R09196	BOMBILLA BULB GU10	449
R09197	BOMBILLA BULB GU10	449
R09202	BOMBILLA BULB G9	445
R09204	BOMBILLA BULB E27	463
R09205	BOMBILLA BULB E27	463
R09206	BOMBILLA BULB E27	462
R09207	BOMBILLA BULB GU10	447

R09208	BOMBILLA BULB E14	451
R09209	BOMBILLA BULB G4	446
R09210	BOMBILLA BULB G4	446
R09211	BOMBILLA BULB E27	456
R09212	BOMBILLA BULB E27	459
R09213	BOMBILLA BULB E27	459
R09214	BOMBILLA BULB GU10	449
R09215	BOMBILLA BULB E27	455
R09218	BOMBILLA BULB GU10	447
R09219	BOMBILLA BULB GU10	447
R09220	BOMBILLA BULB GU10	447
R09221	BOMBILLA BULB E14	453
R09223	BOMBILLA BULB E27	457
R09224	BOMBILLA BULB GX53	465
R09225	BOMBILLA BULB GX53	465
R09226	BOMBILLA BULB G9	444
R09227	BOMBILLA BULB G9	444
R09228	BOMBILLA BULB E27	462
R09229	BOMBILLA BULB E27	461
R09230	BOMBILLA BULB E27	461
R09232	BOMBILLA BULB E27	464
R09233	BOMBILLA BULB E27	464
R09234	BOMBILLA BULB E27	457
R09235	BOMBILLA BULB E27	457
R09237	BOMBILLA BULB E27	454
R09238	BOMBILLA BULB E27	454
R09239	BOMBILLA BULB E14	454
R09240	BOMBILLA BULB E14	454
R09241	BOMBILLA BULB E14	453
R09242	BOMBILLA BULB E14	453
R09243	BOMBILLA BULB G4	446
R09244	BOMBILLA BULB E27	460
R09245	BOMBILLA BULB E27	460
R09246	BOMBILLA BULB E27	460
R09247	BOMBILLA BULB G4	446
R09248	BOMBILLA BULB GX53	465
R09249	BOMBILLA BULB GX53	465
R09250	BOMBILLA BULB E27	456

R09251	BOMBILLA BULB E27	455
R09252	BOMBILLA BULB E27	455
R09253	BOMBILLA BULB E27	455
R09254	BOMBILLA BULB GU10	450
R09255	BOMBILLA BULB GU10	450
R09256	BOMBILLA BULB GU10	450
R09257	BOMBILLA BULB GU10	450
R09258	BOMBILLA BULB GU10	450
R09259	BOMBILLA BULB GU10	450
SKB122	CARRILES TRIFASICOS TRACKS	219
SKB123	CARRILES TRIFASICOS TRACKS	219
TU0492	PIQUETA / SPIKE	443
TU0494	BASE SUJECCION / FIXING BASE	443
TU0652	PIQUETA / SPIKE	443
TU0653	PIQUETA / SPIKE	443
TU0662	CONEXIÓN IP68	442
TU0663	CONEXIÓN IP68	442
XTS112	CARRILES TRIFASICOS TRACKS	219
XTS113	CARRILES TRIFASICOS TRACKS	219
XTS122	CARRILES TRIFASICOS TRACKS	219
XTS123	CARRILES TRIFASICOS TRACKS	219
XTS142	CARRILES TRIFASICOS TRACKS	220
XTS143	CARRILES TRIFASICOS TRACKS	220
XTS212	CARRILES TRIFASICOS TRACKS	220
XTS213	CARRILES TRIFASICOS TRACKS	220
XTS242	CARRILES TRIFASICOS TRACKS	220
XTS243	CARRILES TRIFASICOS TRACKS	220
XTS342	CARRILES TRIFASICOS TRACKS	220
XTS343	CARRILES TRIFASICOS TRACKS	220
XTS352	CARRILES TRIFASICOS TRACKS	220
XTS353	CARRILES TRIFASICOS TRACKS	220
XTS 362	CARRILES TRIFASICOS TRACKS	221
XTS 363	CARRILES TRIFASICOS TRACKS	221
XTS 372	CARRILES TRIFASICOS TRACKS	221

XTS 373	CARRILES TRIFASICOS TRACKS	221
XTS 382	CARRILES TRIFASICOS TRACKS	220
XTS 383	CARRILES TRIFASICOS TRACKS	220
XTS 392	CARRILES TRIFASICOS TRACKS	221
XTS 393	CARRILES TRIFASICOS TRACKS	221
XTS 402	CARRILES TRIFASICOS TRACKS	221
XTS 403	CARRILES TRIFASICOS TRACKS	221
XTS41002	CARRILES TRIFASICOS TRACKS	218
XTS41003	CARRILES TRIFASICOS TRACKS	218
XTS412	CARRILES TRIFASICOS TRACKS	219
XTS413	CARRILES TRIFASICOS TRACKS	219
XTS42002	CARRILES TRIFASICOS TRACKS	218
XTS42003	CARRILES TRIFASICOS TRACKS	218
XTSF102	CARRILES TRIFASICOS TRACKS	219
XTSF103	CARRILES TRIFASICOS TRACKS	219
XTSF302	CARRILES TRIFASICOS TRACKS	219
XTSF303	CARRILES TRIFASICOS TRACKS	219
XTSF41002	CARRILES TRIFASICOS TRACKS	218
XTSF41003	CARRILES TRIFASICOS TRACKS	218
XTSF42002	CARRILES TRIFASICOS TRACKS	218
XTSF42003	CARRILES TRIFASICOS TRACKS	218

## Créditos

### Dirección de arte

Vicente Moya

José Ignacio Ballester

### Fotografías 3D

Javier Gilabert Photographer

Vicente Moreno

Cualiti Photo Studio

Sergi Penalba

Estudios Aviñó

### Diseño gráfico y Comunicación

Amparo Navarro

creativo@mantraco.org

### MANTRA

Pol. Ind. Los Vientos

Calle Alisio, parcela nº4

46119 Náquera · Valencia · Spain

Tel. +34 96 160 99 50

mantra@mantraco.org

### Depto. Nacional

Tel. +34 96 160 99 50

mar@mantraco.org

### Depto. Internacional

Tel. +34 96 160 99 50

c.ando@mantraco.org

© copyright - Global Manufacturing and trading company S.L



Himalaya  
Santiago Sevillano Studio



watch MANTRA videos

