



K U T E K

CLASSIC

Spis treści
Contents
Оглавление



Adria..... 4



Alba 9



Arezzo 14



Baccara..... 16



Bari.....18



Bellagio23



Bibione 27



Cantu 31



Casamia Abażur 34



Casamia Klosz 38



Coco 42



Coco Podśw. 47



Como51



Decor Abażur57



Decor Klosz 60



Dimaro.....64



Ellini69



Elve75



Erba78



Fellino86

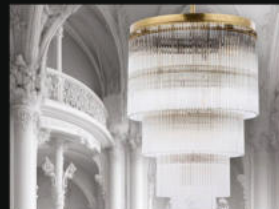

Filago93



Fiore 101



Genova 107



Impla 112



Izano 116



Kiara 124



Lauria127

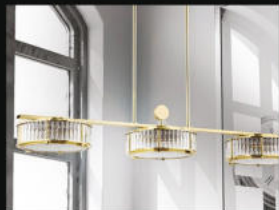

Lavone130



Lea Abażur..... 139



Lea Klosz145



Lido..... 148



Loretto..... 153



Luca.....156



Meleze 160



Merano Abażur 165



Merano Klosz..... 168



Messina.....171



Monza.....,173



N Abażur.....178



N Klosz.....181



Napoli.....185



Nico 189



OBD.....193



Olzano.....197



Orezzo.....200



Prima.....204



Roma Abażur..... 208



Roma Klosz211



Rossano215



Saletto219



San Marino Ab 226



San Marino Kl..... 231



Sienna235



Sorrento 243



Tadea..... 248



Tamara.....251

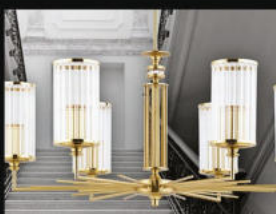

Usini..... 255



Vera..... 257

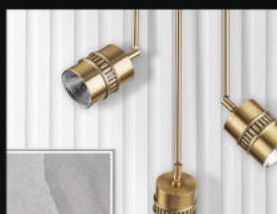

Vesto 259



Zaffiro262

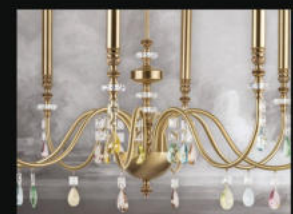

Zeri.....266



Adria

(BN)
BŁYSZCZĄCY NIKIEL
SHINY NICKEL
БЛЕСТЯЩИЙ НИКЕЛЬ



(N)
NIKIEL
ANCIENT NICKEL
АНТИЧНЫЙ НИКЕЛЬ



(P)
PATYNA
PATINA
ПАТИНА



(Z)
ZŁOTO
GOLD
ЗОЛОТО



(ZM)
ZŁOTO MATOWE
MATT GOLD
МАТОВОЕ ЗОЛОТО



Adria

ADR-ZW-1 (BN)

↓ 700 mm ↔ 100 mm

💡 1 x max 40W E14



ADR-ZW-8 (Z)

↓ 700 mm ↔ 760 mm

💡 8 x max 40W E14



Adria



ADR-LS-1 (ZM/A)

↓ 1820 mm ↔ 300 mm

💡 1 x max 60W E27



ADR-ZW-6 (ZM)

↓ 700 mm ↔ 760 mm

💡 6 x max 40W E14

350 mm

Adria

ADR-ZWL-8 (BN)

↓ 700 mm ↔ 800/1200 mm
⊙ 8 x max 40W E14



ADR-ZW-10 (P)

↓ 700 mm ↔ 1180 mm
⊙ 10 x max 40W E14



Adria



ADR-LG-1 (ZM/A)

↑ 740 mm ↔ 300 mm
💡 1 x max 60W E27

ADR-K-1 (P)

↑ 340 mm ↔ 120 mm |→ 170 mm
💡 1 x max 40W E14



ADR-ZW-10+5 (ZM)

↑ 900 mm ↔ 1180 mm
💡 15 x max 40W E14



600 mm



Alba

(BN)
BŁYSZCZĄCY NIKIEL
SHINY NICKEL
БЛЕСТЯЩИЙ НИКЕЛЬ



(N)
NIKIEL
ANCIENT NICKEL
АНТИЧНЫЙ НИКЕЛЬ



(P)
PATYNA
PATINA
ПАТИНА



(Z)
ZŁOTO
GOLD
ЗОЛОТО



(ZM)
ZŁOTO MATOWE
MATT GOLD
МАТОВОЕ ЗОЛОТО



Alba



ALB-ZW-1 (P) 150

↓ 700 mm ↔ 150 mm

💡 1 x max 40W E14



ALB-ZW-1 (P) 250

↓ 700 mm ↔ 250 mm

💡 2 x max 40W E14



ALB-ZW-1 (P) 290

↓ 700 mm ↔ 290 mm

💡 2 x max 40W E14



160 mm



230 mm

260 mm

ALB-LS-1 (ZM)

↓ 1700 mm ↔ 300 mm

💡 2 x max 40W E14

Alba

ALB-LN-2 (ZM)

↑ 320 mm ↔ 250 mm
⊙ 2 x max 40W E14



ALB-ZW-12 (Z)

↑ 800 mm ↔ 770 mm
⊙ 12 x max 40W E14



Alba

ALB-K-1 (Z)

↑ 360 mm ↔ 150 mm ↳ 290 mm
⊙ 1 x max 40W E14



ALB-ZW-6 (ZM)

↑ 700 mm ↔ 740 mm
⊙ 6 x max 40W E14



Alba



ALB-LG-1 (ZM)

↓ 650 mm ↔ 150/280 mm
💡 1 x max 40W E14



ALB-ZW-8 (P)

↓ 700 mm ↔ 770 mm
💡 8 x max 40W E14



430 mm



Arezzo

(N)
NIKIEL
ANCIENT NICKEL
АНТИЧНЫЙ НИКЕЛЬ

(P)
PATYNA
PATINA
ПАТИНА

(Z)
ZŁOTO
GOLD
ЗОЛОТО



Arezzo

ARE-PL-8 (N) 300

↑ min. 800 mm ↔ 300 mm

💡 8 x max 40W E14



ARE-PL-8 (P) 400

↑ min. 950 mm ↔ 400 mm

💡 8 x max 40W E14

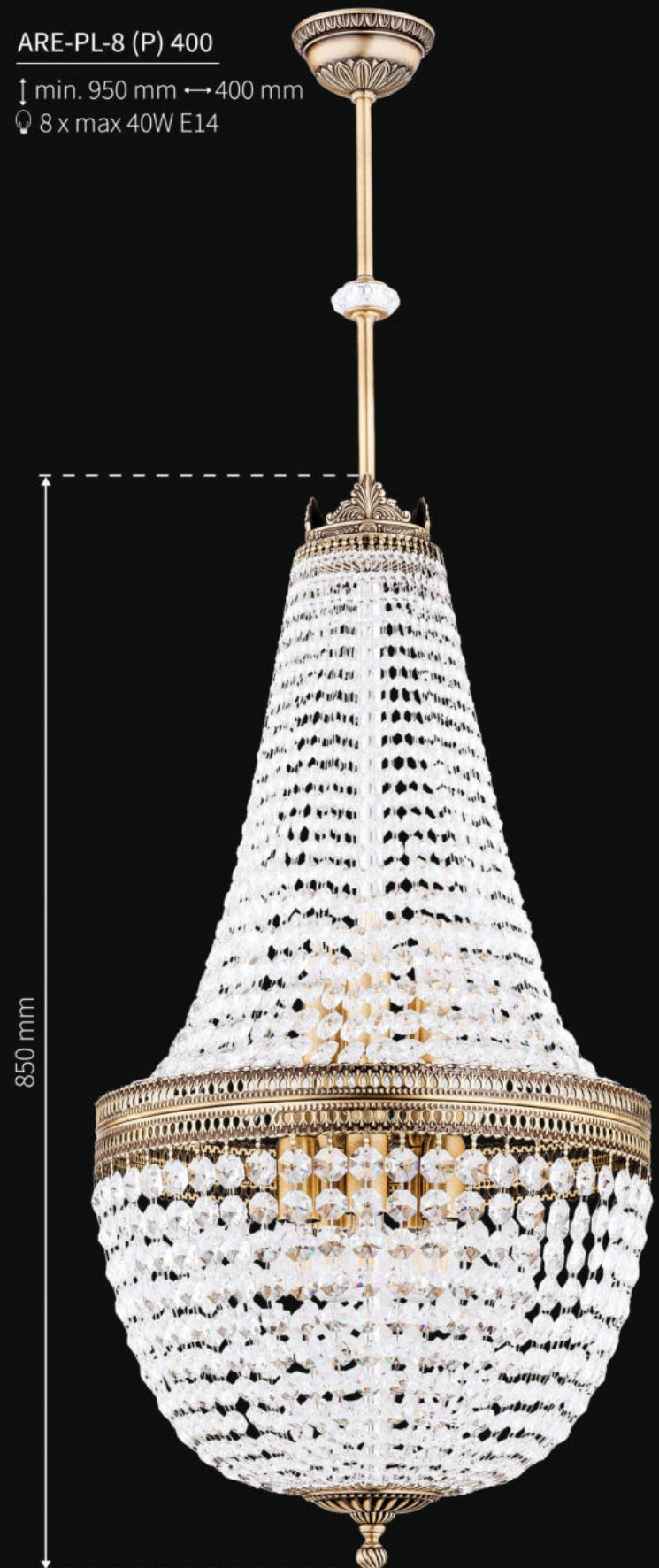



Baccara

(N)
NIKIEL
ANCIENT NICKEL
АНТИЧНЫЙ НИКЕЛЬ

(P)
ПАТІНА
PATINA
ПАТИНА

(ZM)
ZŁOTO MATOWE
MATT GOLD
МАТОВОЕ ЗОЛОТО



Baccara

BAC-PLM-3 (P) 300

↑ 240 mm ↔ 300 mm
💡 3 x max 60W E27



BAC-K-1 (P)

↑ 260 mm ↔ 220 mm | → 280 mm
💡 1 x max 60W E27



BAC-PLM-3 (P) 400

↑ 270 mm ↔ 400 mm
💡 3 x max 60W E27





Bari

(BN)
BŁYSZCZĄCY NIKIEL
SHINY NICKEL
БЛЕСТЯЩИЙ НИКЕЛЬ



(N)
NIKIEL
ANCIENT NICKEL
АНТИЧНЫЙ НИКЕЛЬ



(P)
PATYNA
PATINA
ПАТИНА



(Z)
ZŁOTO
GOLD
ЗОЛОТО



(ZM)
ZŁOTO MATOWE
MATT GOLD
МАТОВОЕ ЗОЛОТО



Bari

BAR-ZW-8+4 (BN)

↑ 1000 mm ↔ 880 mm

⊙ 24 x G9 max 5W



Bari

BAR-LS-3 (ZM)

↑ 1750 mm ↔ 330 mm
💡 6 x G9 max 5W

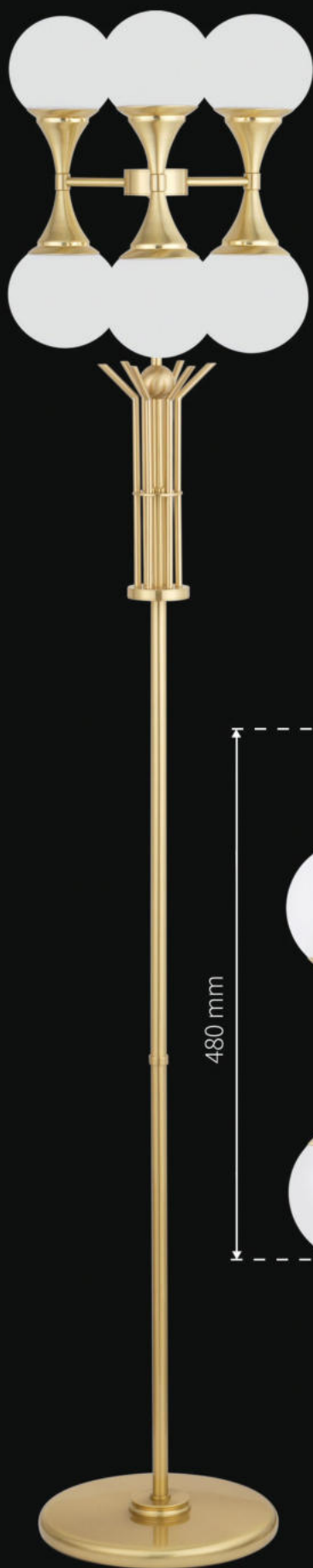

BAR-ZW-6 (Z)

↑ 700 mm ↔ 850 mm
💡 12 x G9 max 5W

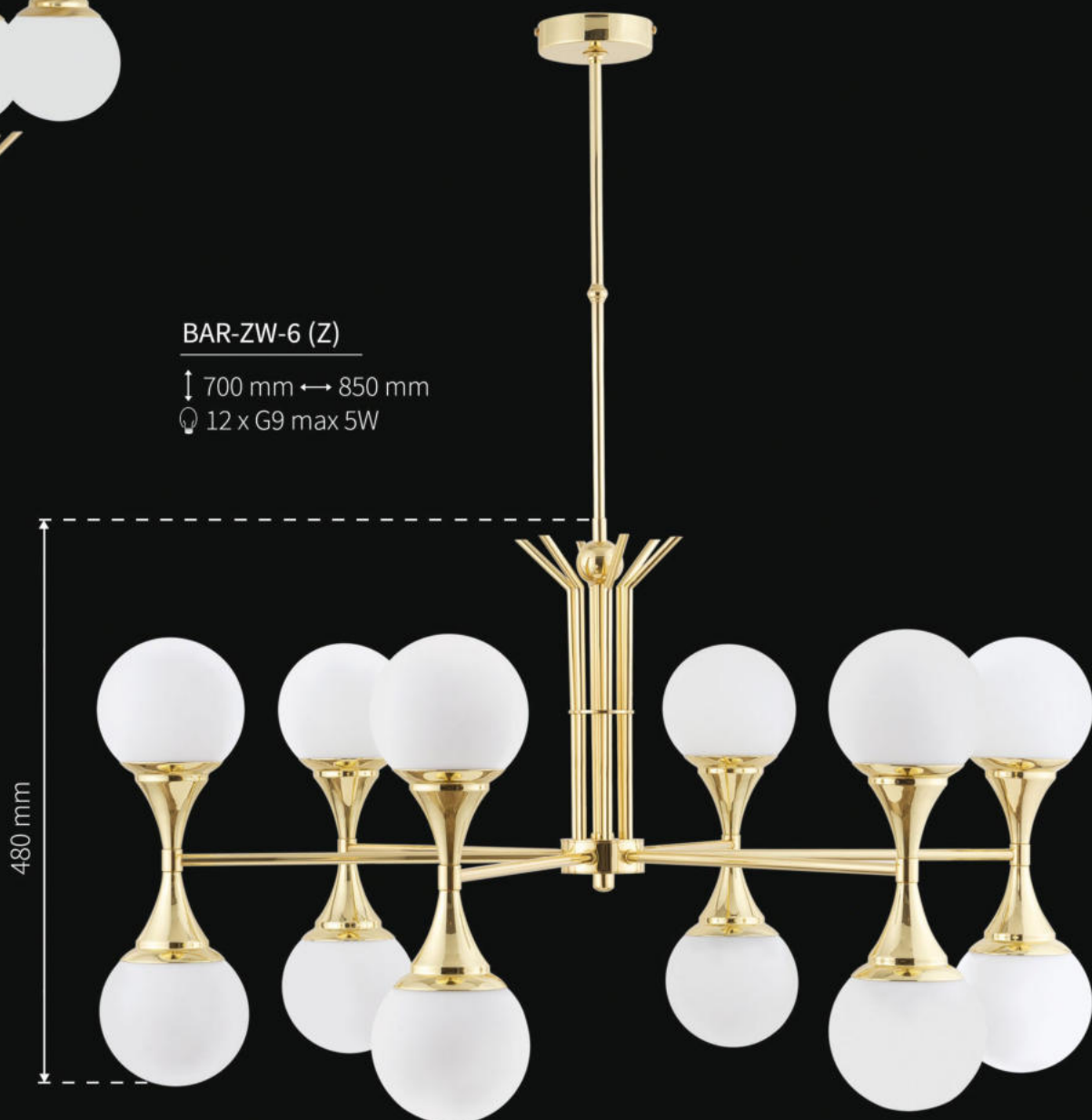

Bari

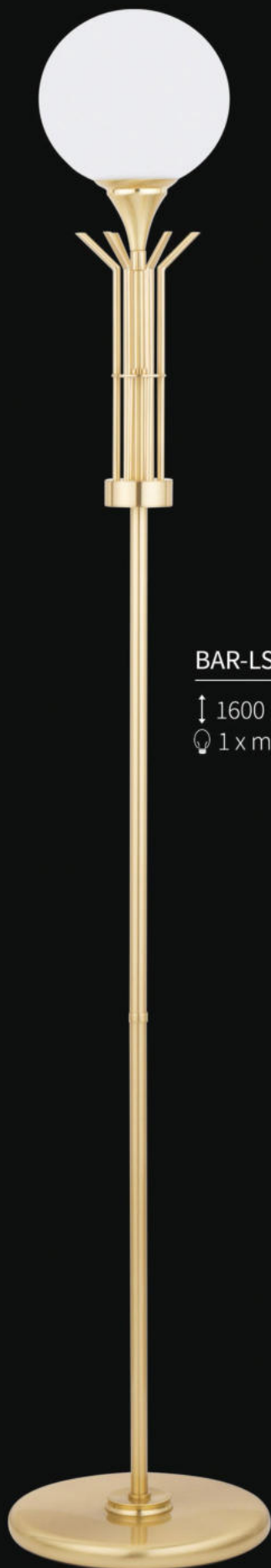

BAR-LS-1 (ZM)

↑ 1600 mm ↔ 280 mm
💡 1 x max 60W E27



BAR-K-2 (Z)

↑ 360 mm ↔ 120 mm ↔ 140 mm
💡 2 x G9 max 5W



BAR-ZW-3 (Z)

↑ 700 mm ↔ 500 mm
💡 6 x G9 max 5W



480 mm

Bari



BAR-LG-1 (P)

↓ 510 mm ↔ 130 mm

💡 1 x G9 max 5W



BAR-ZW-8 (ZM)

↓ 700 mm ↔ 850 mm

💡 16 x G9 max 5W

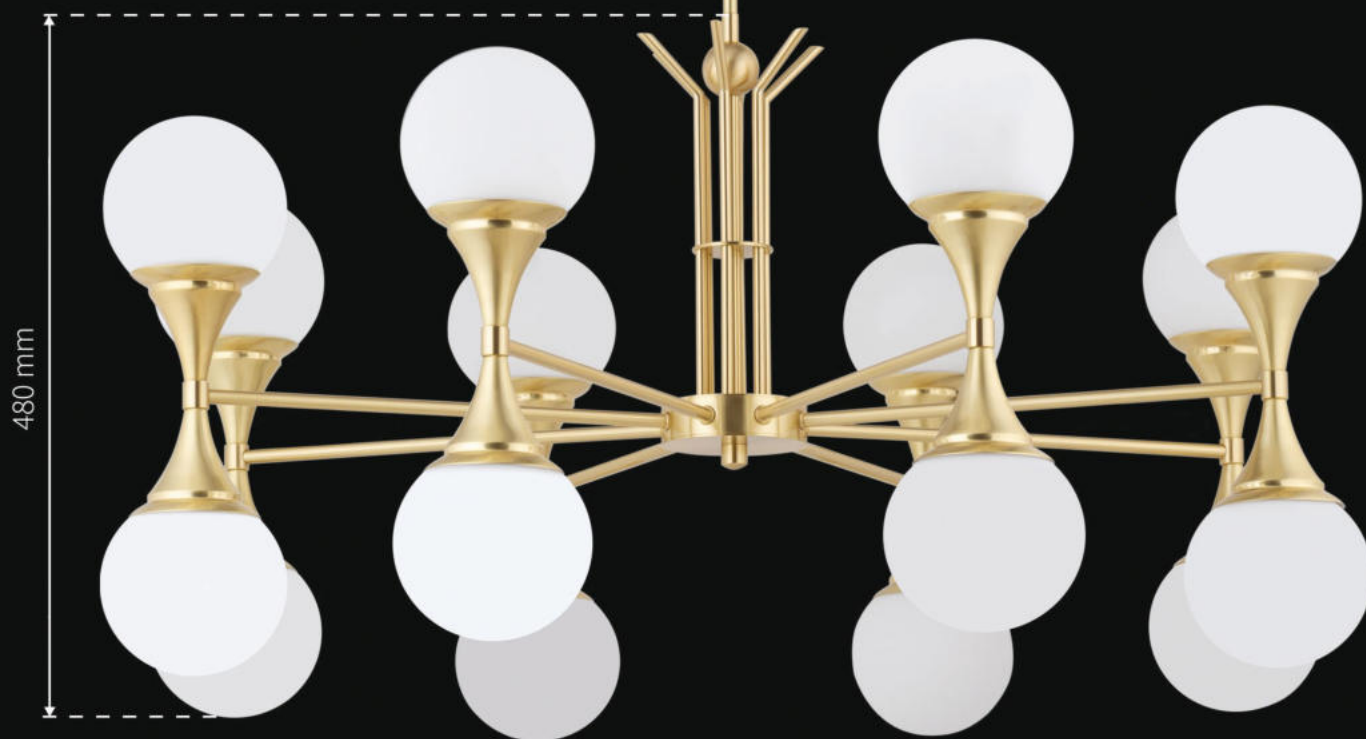



Bellagio

(BN)
BŁYSZCZĄCY NIKIEL
SHINY NICKEL
БЛЕСТЯЩИЙ НИКЕЛЬ



(N)
NIKIEL
ANCIENT NICKEL
АНТИЧНЫЙ НИКЕЛЬ



(P)
PATYNA
PATINA
ПАТИНА



(Z)
ZŁOTO
GOLD
ЗОЛОТО



(ZM)
ZŁOTO MATOWE
MATT GOLD
МАТОВОЕ ЗОЛОТО



Bellagio



BEL-PL-3 (P) 470 CR

↓ 210 mm ↔ 470 mm
⊙ 3 x max 60W E27



BEL-PL-3 (P) 470 OZ CR

↓ 210 mm ↔ 470 mm
⊙ 3 x max 60W E27



BEL-PL-3 (P) 470

↓ 210 mm ↔ 470 mm
⊙ 3 x max 60W E27



BEL-PL-3 (P)

↓ 180 mm ↔ 600 mm
⊙ 3 x max 60W E27

Bellagio



BEL-PL-3 (P) CR

↑ 180 mm ↔ 600 mm
💡 3 x max 60W E27



BEL-PL-3 (Z) CR

↑ 180 mm ↔ 600 mm
💡 3 x max 60W E27



BEL-PL-3 (P) OZ CR

↑ 180 mm ↔ 600 mm
💡 3 x max 60W E27



BEL-PL-3 (N) 470 CR

↑ 210 mm ↔ 470 mm
💡 3 x max 60W E27

Bellagio



BEL-MOD-PL-3 (N) CR

↓ 140 mm ↔ 500 mm
💡 3 x max 60W E27



BEL-PL-3 (BN)

↓ 180 mm ↔ 600 mm
💡 3 x max 60W E27



BEL-MOD-PL-3 (N)

↓ 140 mm ↔ 500 mm
💡 3 x max 60W E27



Bibione

(N)
NIKIEL
ANCIENT NICKEL
АНТИЧНЫЙ НИКЕЛЬ

(P)
PATYNA
PATINA
ПАТИНА

(Z)
ZŁOTO
GOLD
ЗОЛОТО

(ZM)
ZŁOTO MATOWE
MATT GOLD
МАТОВОЕ ЗОЛОТО



Bibione

BIB-ZW-8 (Z/A) CR

↑ 980 mm ↔ 980 mm

⊙ 14 x max 40W E14



BIB-K-2 (P/A)

↑ 365 mm ↔ 440 mm |→ 240 mm

⊙ 2 x max 40W E14

K-2 - PODWÓJNY KINKIET / DOUBLE WALL LAMP / ДВОЙНОЕ БРА
(A) - ABAŻURY / LAMP SHADES / АБАЖУРЫ

ZW - ŻYRANDOL / CHANDELIER / ЛЮСТРА
CR - WERSJA Z KRYSTAŁAMI / WERSION WITH CRYSTALS / ВЕРСИЯ С КРИСТАЛЛАМИ

Bibione

BIB-LG-1 (Z/A)

↑ 540 mm ↔ 320 mm

💡 1 x max 60W E27



BIB-ZW-6 (P/A) CR

↑ 900 mm ↔ 880 mm

💡 9 x max 40W E14



(A) - ABAŻURY / LAMP SHADES / АБАЖУРЫ
ZW - ŻYRANDOL / CHANDELIER / ЛЮСТРА

LG - LAMPA GABINETOWA / DESK LAMP / КАБИНЕТНАЯ ЛАМПА
CR - WERSJA Z KRYSTAŁAMI / VERSION WITH CRYSTALS /
ВЕРСИЯ С КРИСТАЛЛАМИ

Bibione

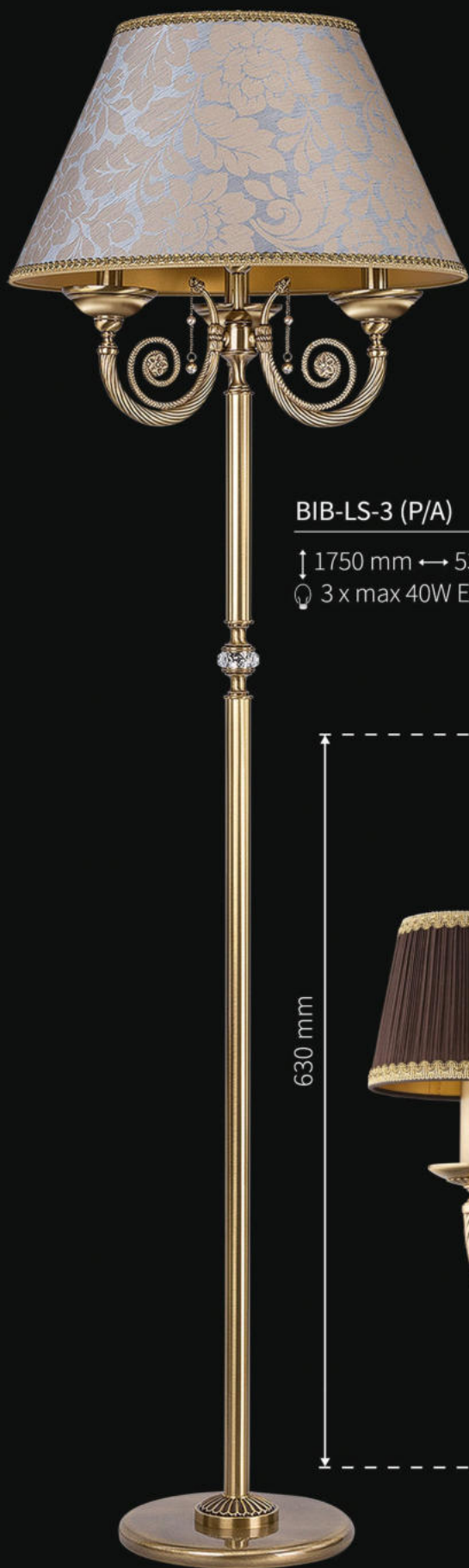

BIB-LS-3 (P/A)

↑ 1750 mm ↔ 530 mm

⦿ 3 x max 40W E14

BIB-K-1 (P/A)

↑ 365 mm ↔ 160 mm ↳ 270 mm

⦿ 1 x max 40W E14



BIB-ZW-3 (P/A) CR

↑ 830 mm ↔ 800 mm

⦿ 6 x max 40W E14

630 mm



(A) - ABAŻURY / LAMP SHADES / АБАЖУРЫ
LS - LAMPA PODŁOGOWA / FLOOR LAMP / ТОРШЕР
K - KINKIET / WALL LAMP / БРА

ZW - ŻYRANDOL / CHANDELIER / ЛЮСТРА
CR - WERSJA Z KRYSTAŁAMI / WERSION WITH
CRYSTALS / ВЕРСИЯ С КРИСТАЛЛАМИ



Cantu

(BN)
BŁYSZCZĄCY NIKIEL
SHINY NICKEL
БЛЕСТЯЩИЙ НИКЕЛЬ



(N)
NIKIEL
ANCIENT NICKEL
АНТИЧНЫЙ НИКЕЛЬ



(P)
PATYNA
PATINA
ПАТИНА



(Z)
ZŁOTO
GOLD
ЗОЛОТО



(ZM)
ZŁOTO MATOWE
MATT GOLD
МАТОВОЕ ЗОЛОТО



Cantu

CAN-K-1 (P/A) GEN

↑ 950 mm ↔ 120 mm | → 140 mm
💡 1 x max 40W E14

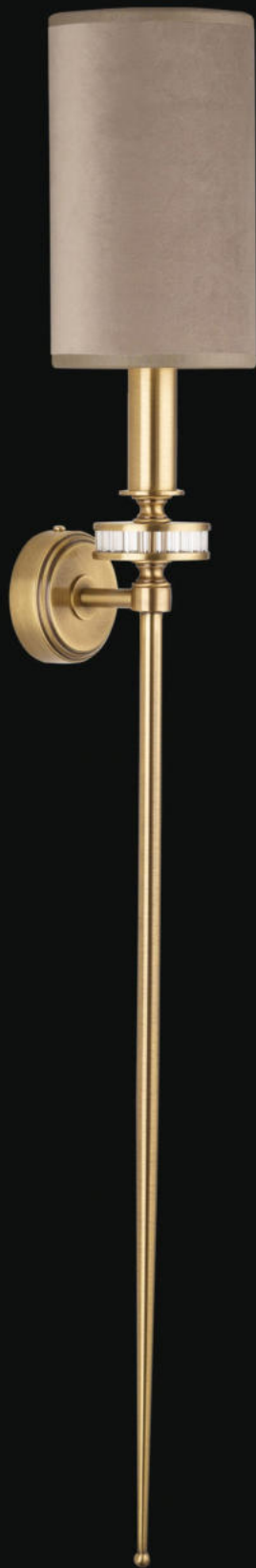

CAN-K-1 (N/A) ZOL

↑ 935 mm ↔ 120 mm | → 150 mm
💡 1 x max 40W E14



CAN-K-1 (ZM) GEN/100

↑ 840 mm ↔ 100 mm | → 140 mm
💡 1 x max 40W E14

CAN-K-1 (BN) ZOL/100

↑ 850 mm ↔ 100 mm | → 140 mm
💡 1 x max 40W E14

Cantu



CAN-K-1 (ZM) SZ/50

↑ 1050 mm ↔ 80 mm ↳ 115 mm
💡 1 x max 40W E14



CAN-K-1 (ZM/1) T/70

↑ 900 mm ↔ 80 mm ↳ 120 mm
💡 1 x max 40W E14



CAN-K-1 (ZM/1) B/70

↑ 900 mm ↔ 80 mm ↳ 120 mm
💡 1 x max 40W E14



Casamia Abazur

(BN)
BŁYSZCZĄCY NIKIEL
SHINY NICKEL
БЛЕСТЯЩИЙ НИКЕЛЬ



(N)
NIKIEL
ANCIENT NICKEL
АНТИЧНЫЙ НИКЕЛЬ



(P)
PATYNA
PATINA
ПАТИНА



(Z)
ZŁOTO
GOLD
ЗОЛОТО



(ZM)
ZŁOTO MATOWE
MATT GOLD
МАТОВОЕ ЗОЛОТО



Casamia Abazur



Casamia Abazur

CAS-ZW-10 (P/A)

↑ 700 mm ↔ 910 mm
⊙ 10 x max 40W E14

450 mm



CAS-K-1 (P/A)

↑ 250 mm ↔ 170 mm | → 310 mm
⊙ 1 x max 40W E14



CAS-ZW-8 (P/A)

↑ 700 mm ↔ 770 mm
⊙ 8 x max 40W E14

380 mm



Casamia Abazur

CAS-ZW-3 (P/A)

↑ 700 mm ↔ 640 mm

💡 3 x max 40W E14



360 mm



CAS-K-2 (P/A)

↑ 250 mm ↔ 360 mm | → 270 mm

💡 2 x max 40W E14



CAS-LG-1 (P/A)

↑ 480 mm ↔ 300 mm

💡 1 x max 60W E27



Casamia Klosz

(BN)
BŁYSZCZĄCY NIKIEL
SHINY NICKEL
БЛЕСТЯЩИЙ НИКЕЛЬ



(N)
NIKIEL
ANCIENT NICKEL
АНТИЧНЫЙ НИКЕЛЬ



(P)
PATYNA
PATINA
ПАТИНА

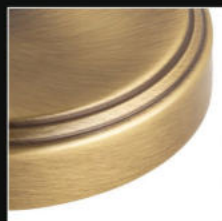

(Z)
ZŁOTO
GOLD
ЗОЛОТО



(ZM)
ZŁOTO MATOWE
MATT GOLD
МАТОВОЕ ЗОЛОТО



Casamia Klosz



CAS-ZW-6 (P)

↑ 700 mm ↔ 810 mm

💡 6 x max 60W E27



CAS-LG-1 (P)

↑ 370 mm ↔ 300 mm

💡 1 x max 60W E27

Casamia Klosz

CAS-ZW-8 (P)

↑ 700 mm ↔ 980 mm
⊙ 8 x max 60W E27



CAS-K-1 (P)

↑ 270 mm ↔ 250 mm ↳ 370 mm
⊙ 1 x max 60W E27

Casamia Klosz

CAS-ZW-5 (P)

↑ 700 mm ↔ 810 mm

⊙ 5 x max 60W E27



CAS-ZW-3 (P)

↑ 700 mm ↔ 710 mm

⊙ 3 x max 60W E27





Coco

(BN)
BŁYSZCZĄCY NIKIEL
SHINY NICKEL
БЛЕСТЯЩИЙ НИКЕЛЬ



(N)
NIKIEL
ANCIENT NICKEL
АНТИЧНЫЙ НИКЕЛЬ



(P)
PATYNA
PATINA
ПАТИНА



(Z)
ZŁOTO
GOLD
ЗОЛОТО



(ZM)
ZŁOTO MATOWE
MATT GOLD
МАТОВОЕ ЗОЛОТО



Coco

COC-ZW-6 (Z/A)

↓ 700 mm ↔ 730 mm
⊙ 6 x max 40W E14



COC-ZW-8 (P/A)

↓ 800 mm ↔ 900 mm
⊙ 8 x max 40W E14



Coco



570 mm

COC-ZW-3 (P/A)

↑ 700 mm ↔ 680 mm

⊙ 3 x max 40W E14



570 mm

COC-ZW-5 (P/A)

↑ 700 mm ↔ 730 mm

⊙ 5 x max 40W E14

Coco



COC-LS-3 (P/A)

↑ 1720 mm ↔ 530 mm
💡 3 x max 40W E14



COC-K-1 (Z/A)

↑ 290 mm ↔ 180 mm ↳ 360 mm
💡 1 x max 40W E14



COC-LG-1 (P/A)

↑ 600 mm ↔ 320 mm
💡 1 x max 60W E27

Coco



COC-K-2 (P/A)

↑ 290 mm ↔ 380 mm ↳ 340 mm
💡 2 x max 40W E14



COC-ZW-12 (N/A)

↑ 900 mm ↔ 920 mm
💡 12 x max 40W E14

700 mm





Coco Podświetlenia

(BN)
BŁYSZCZĄCY NIKIEL
SHINY NICKEL
БЛЕСТЯЩИЙ НИКЕЛЬ



(N)
NIKIEL
ANCIENT NICKEL
АНТИЧНЫЙ НИКЕЛЬ



(P)
PATYNA
PATINA
ПАТИНА



(Z)
ZŁOTO
GOLD
ЗОЛОТО



(ZM)
ZŁOTO MATOWE
MATT GOLD
МАТОВОЕ ЗОЛОТО



Coco Podświetlenia

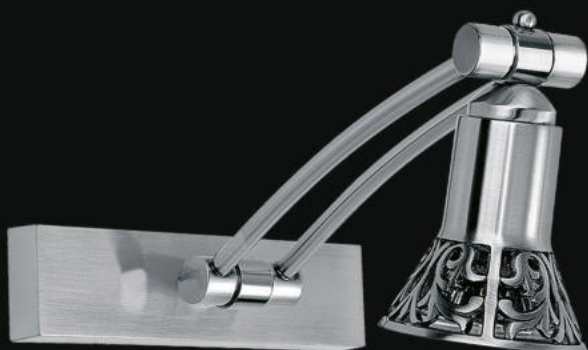

COC-PODS-1 (N) 200

↑ 200 mm ↔ 160 mm
⊙ 1 x max 35W GU10



COC-PODS-1 (N) 350

↑ 350 mm ↔ 160 mm
⊙ 1 x max 35W GU10



COC-PODS-1 (N) 200-CR

↑ 200 mm ↔ 160 mm
⊙ 1 x max 35W GU10



COC-PODS-1 (N) 350-CR

↑ 350 mm ↔ 160 mm
⊙ 1 x max 35W GU10

Coco Podświetlenia

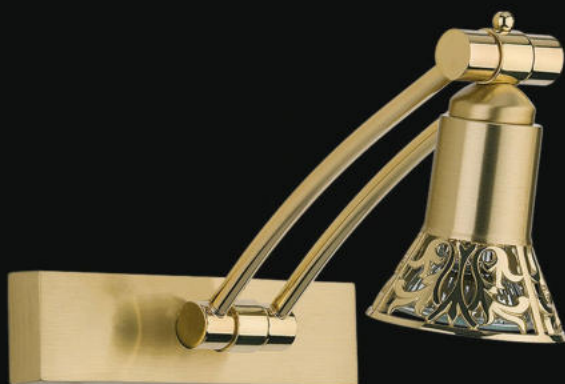

COC-PODS-1 (Z) 200

↑ 200 mm ↔ 160 mm
⦿ 1 x max 35W GU10



COC-PODS-1 (Z) 350

↑ 350 mm ↔ 160 mm
⦿ 1 x max 35W GU10



COC-PODS-1 (Z) 200-CR

↑ 200 mm ↔ 160 mm
⦿ 1 x max 35W GU10



COC-PODS-1 (Z) 350-CR

↑ 350 mm ↔ 160 mm
⦿ 1 x max 35W GU10

Coco Podświetlenia



COC-PODS-1 (P) 200

↓ 200 mm ↔ 160 mm
⊙ 1 x max 35W GU10



COC-PODS-1 (P) 350

↓ 350 mm ↔ 160 mm
⊙ 1 x max 35W GU10



COC-PODS-1 (P) 200-CR

↓ 200 mm ↔ 160 mm
⊙ 1 x max 35W GU10



COC-PODS-1 (P) 350-CR

↓ 350 mm ↔ 160 mm
⊙ 1 x max 35W GU10



Como

(1) CZARNY
BLACK
ЧЕРНЫЙ

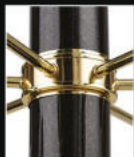

(BN) BŁYSZCZĄCY NIKIEL
SHINY NICKEL
БЛЕСТЯЩИЙ НИКЕЛЬ



(2) CIEMNOSZARY
DARK GREY
ТЕМНО-СЕРЫЙ

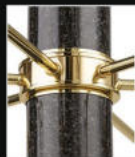

(N) NIKIEL
ANCIENT NICKEL
АНТИЧНЫЙ НИКЕЛЬ



(3) JASNOSZARY
LIGHT GRAY
СВЕТЛО-СЕРЫЙ

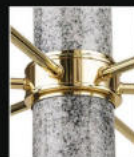

(P) PATYNA
PATINA
ПАТИНА



(4) BRĄZOWY
BROWN
КОРИЧНЕВЫЙ

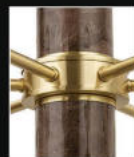

(Z) ZŁOTO
GOLD
ЗОЛОТО



(5) ZIELONY
GREEN
ЗЕЛЕНЫЙ

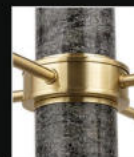

(ZM) ZŁOTO MATOWE
MATT GOLD
МАТОВОЕ ЗОЛОТО



(6) BEŻOWY
BEIGE
БЕЖЕВЫЙ



Como



COM-K-1 (P/6) T

↓ 200 mm ↔ 120 mm | → 175 mm
💡 1 x G9 max 5W



COM-K-1 (P/1) T

↓ 200 mm ↔ 120 mm | → 175 mm
💡 1 x G9 max 5W

COM-ZW-8 (ZM/4) T

↓ 700 mm ↔ 720 mm
💡 8 x G9 max 5W



Como

COM-ZW-4 (Z/2) T

↓ 700 mm ↔ 720 mm
⊙ 4 x G9 max 5W



COM-ZW-6 (BN/3) T

↓ 700 mm ↔ 720 mm
⊙ 6 x G9 max 5W



Como



COM-K-1 (P/6) B

↑ 200 mm ↔ 120 mm |→ 175 mm
⊙ 1 x G9 max 5W

COM-K-1 (P/1) B

↑ 200 mm ↔ 120 mm |→ 175 mm
⊙ 1 x G9 max 5W



COM-ZW-4 (Z/2) B

↑ 700 mm ↔ 740 mm
⊙ 4 x G9 max 5W

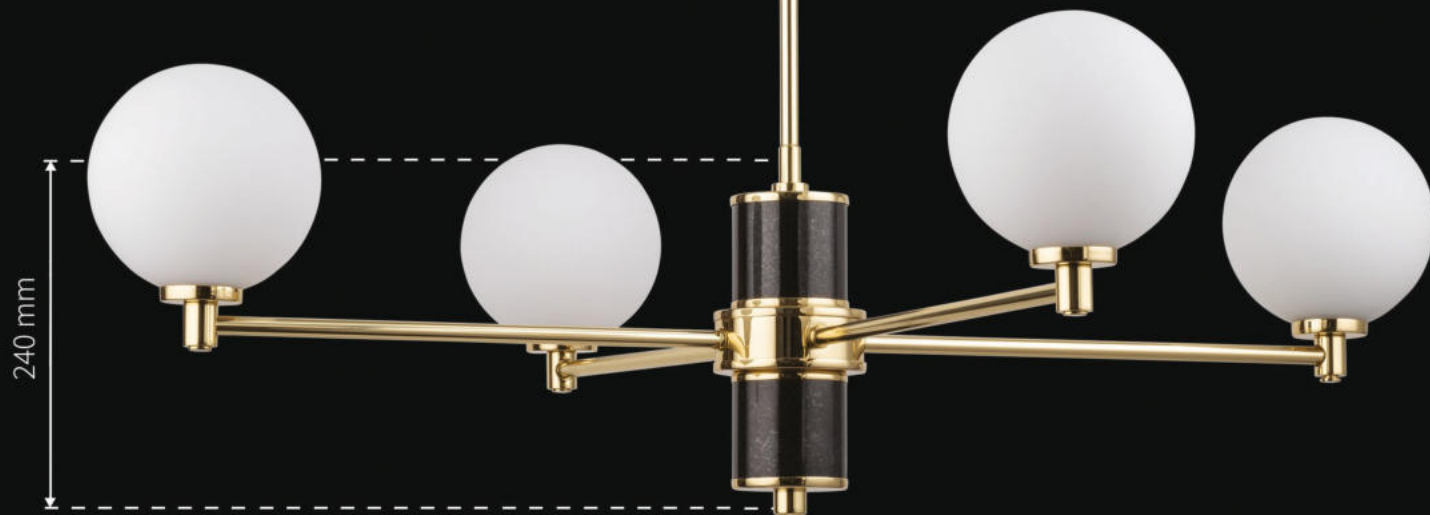

Como

COM-ZW-6 (BN/3) B

↑ 700 mm ↔ 740 mm

⊙ 6 x G9 max 5W



COM-ZW-8 (ZM/4) B

↑ 700 mm ↔ 740 mm

⊙ 8 x G9 max 5W

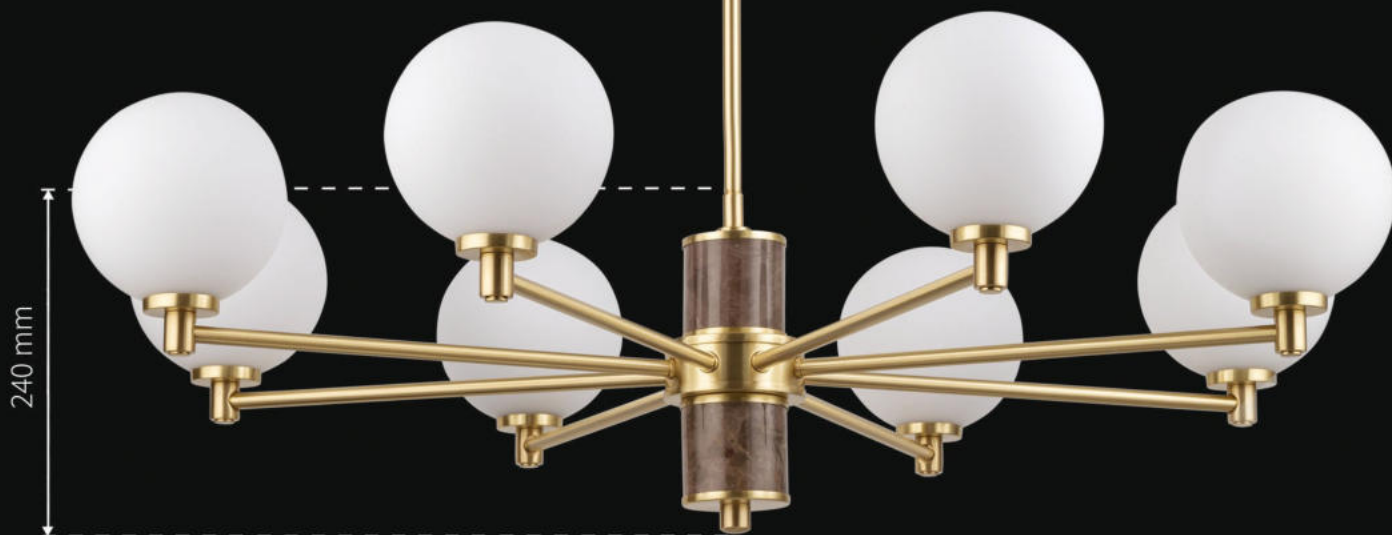

Como

COM-ZW-8+4 (BN/1) T

↑ 700 mm ↔ 1180 mm

⊙ 12 x G9 max 5W



COM-ZW-8+4 (BN/1) B

↑ 700 mm ↔ 1200 mm

⊙ 12 x G9 max 5W



ZW - ŻYRANDOL / CHANDELIER / ЛЮСТРА
B - BIAŁY KLOSZ / WHITE GLASS / БЕЛОЕ СТЕКЛО

T - TRANSPARENTNY KLOSZ / TRANSPARENT GLASS /
ПРОЗРАЧНЫЙ СТЕКЛЯННЫЙ ПЛАФОН



Decor Abazur

(BN)
BŁYSZCZĄCY NIKIEL
SHINY NICKEL
БЛЕСТЯЩИЙ НИКЕЛЬ



(N)
NIKIEL
ANCIENT NICKEL
АНТИЧНЫЙ НИКЕЛЬ



(P)
PATYNA
PATINA
ПАТИНА



(Z)
ZŁOTO
GOLD
ЗОЛОТО



(ZM)
ZŁOTO MATOWE
MATT GOLD
МАТОВОЕ ЗОЛОТО



Decor Abazur

DEC-ZW-6 (P/A)

↑ 700 mm ↔ 750 mm

⊙ 6 x max 40W E14

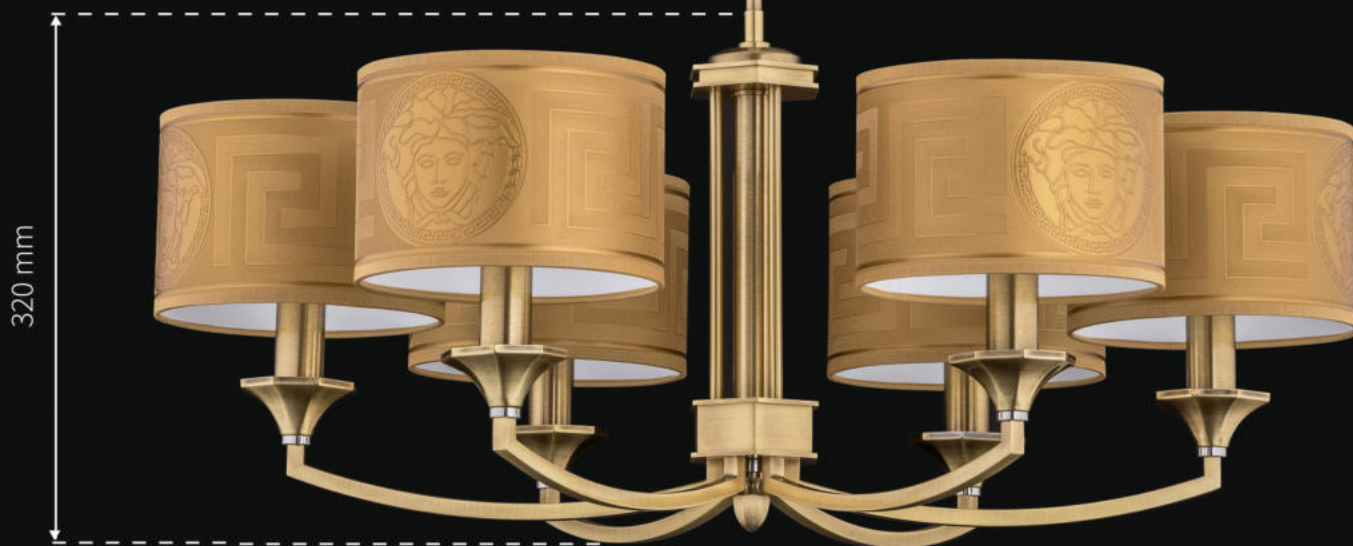

DEC-ZW-3 (BN/A)

↑ 700 mm ↔ 750 mm

⊙ 3 x max 40W E14



Decor Abazur



DEC-LS-1 (P/A)

↑ 1720 mm ↔ 400 mm
⊙ 1 x max 60W E27



DEC-K-2 (P/A)

↑ 270 mm ↔ 395 mm ↳ 205 mm
⊙ 2 x max 40W E14



DEC-K-1 (P/A)

↑ 270 mm ↔ 180 mm ↳ 240 mm
⊙ 1 x max 40W E14



DEC-LG-1 (P/A)

↑ 570 mm ↔ 320 mm
⊙ 1 x max 60W E27



Decor Klosz

(BN)
BŁYSZCZĄCY NIKIEL
SHINY NICKEL
БЛЕСТЯЩИЙ НИКЕЛЬ



(N)
NIKIEL
ANCIENT NICKEL
АНТИЧНЫЙ НИКЕЛЬ



(P)
PATYNA
PATINA
ПАТИНА



(Z)
ZŁOTO
GOLD
ЗОЛОТО



(ZM)
ZŁOTO MATOWE
MATT GOLD
МАТОВОЕ ЗОЛОТО



Decor Klosz

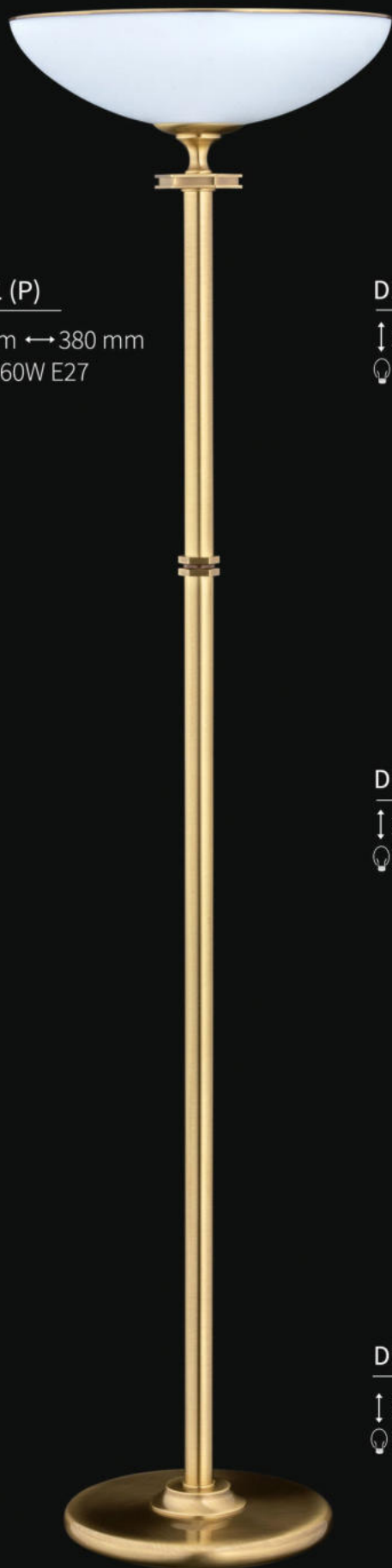

DEC-LS-1 (P)

↑ 1700 mm ↔ 380 mm
💡 1 x max 60W E27



DEC-PLM-3 (P) 470

↑ 200 mm ↔ 470 mm
💡 3 x max 60W E27



DEC-PLM-3 (P)

↑ 290 mm ↔ 500 mm
💡 3 x max 60W E27



DEC-PL-3 (P)

↑ 560 mm ↔ 500 mm
💡 3 x max 60W E27

Decor Klosz

DEC-ZW-6 (P)

↑ 680 mm ↔ 800 mm

💡 6 x max 60W E27

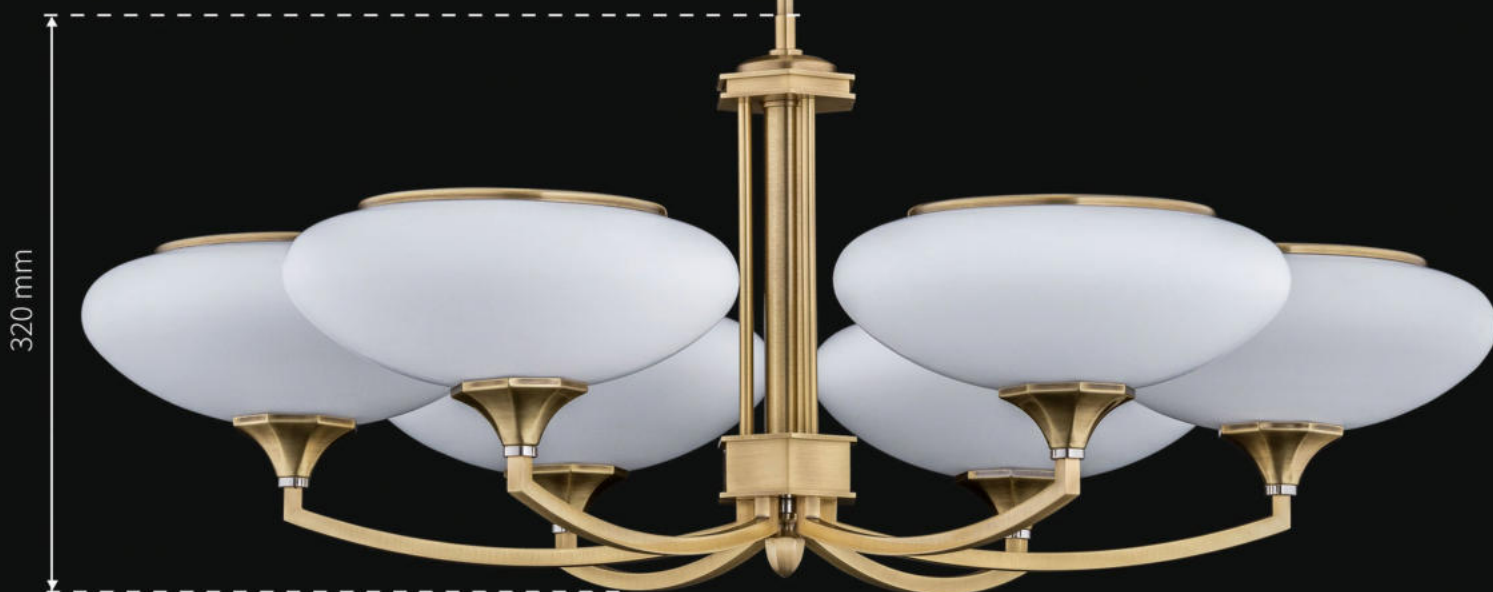

DEC-K-1 (P)

↑ 180 mm ↔ 250 mm ↳ 290 mm

💡 1 x max 60W E27

Decor Klosz

DEC-ZW-3 (P)

↓ 700 mm ↔ 800 mm

💡 3 x max 60W E27

320 mm



DEC-LG-1 (P)

↓ 520 mm ↔ 300 mm

💡 1 x max 60W E27





Dimaro

(BN)
BŁYSZCZĄCY NIKIEL
SHINY NICKEL
БЛЕСТЯЩИЙ НИКЕЛЬ



(N)
NIKIEL
ANCIENT NICKEL
АНТИЧНЫЙ НИКЕЛЬ



(P)
PATYNA
PATINA
ПАТИНА



(Z)
ZŁOTO
GOLD
ЗОЛОТО



(ZM)
ZŁOTO MATOWE
MATT GOLD
МАТОВОЕ ЗОЛОТО



Dimaro



DIM-K-2 (P)

↑ 390 mm ↔ 160 mm |→ 180 mm
💡 2 x max 60W E27

DIM-K-1 (P)

↑ 230 mm ↔ 160 mm |→ 200 mm
💡 1 x max 60W E27



DIM-LS-1 (P)

↑ 1640 mm ↔ 300 mm
💡 1 x max 60W E27

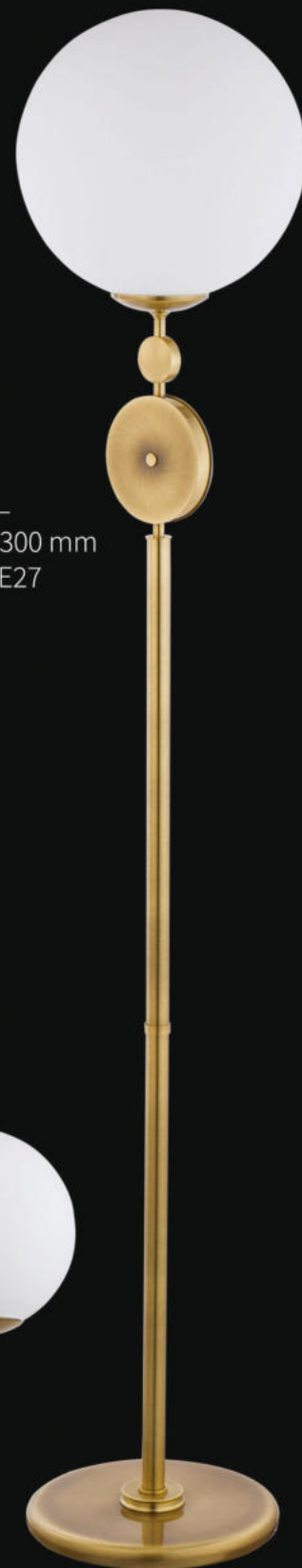

DIM-ZW-6 (P)

↑ 700 mm ↔ 820 mm
💡 6 x max 60W E27



Dimaro

DIM-ZW-8+4 (Z)

↑ 850 mm ↔ 920 mm

💡 12 x max 60W E27



DIM-PL-3 (ZM) CR

↑ 110 mm ↔ 580 mm

💡 3 x max 60W E27



DIM-PL-3 (ZM)

↑ 110 mm ↔ 580 mm

💡 3 x max 60W E27



Dimaro

DIM-ZWL-4 (BN)

↑ 700 mm ↔ 1250 mm
⊙ 4 x max 60W E27

DIM-LG-1 (BN)

↑ 440 mm ↔ 200 mm
⊙ 1 x max 60W E27

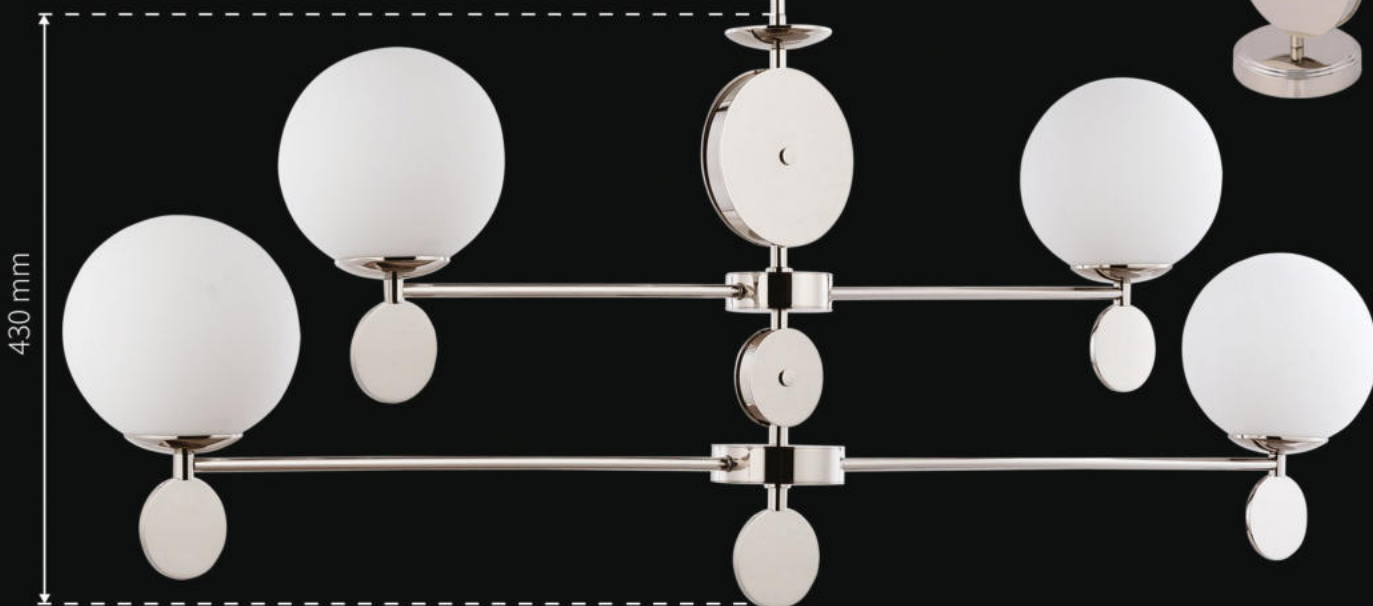

DIM-ZW-8 (N)

↑ 700 mm ↔ 920 mm
⊙ 8 x max 60W E27



ZWL - ŻYRANDOL W FORMIE LINII / CHANDELIER IN
THE FORM OF THE LINE / ЛЮСТРА В ФОРМЕ ЛИНИИ

ZW - ŻYRANDOL / CHANDELIER / ЛЮСТРА
LG - LAMPA GABINETOWA / DESK LAMP /
КАБИНЕТНАЯ ЛАМПА

Dimaro

DIM-ZW-1 (BN) 300

↑ 700 mm ↔ 300 mm
💡 1 x max 60W E27



DIM-ZW-1 (BN) 200

↑ 700 mm ↔ 200 mm
💡 1 x max 60W E27



DIM-ZW-1 (BN) 160

↑ 700 mm ↔ 160 mm
💡 1 x max 60W E27

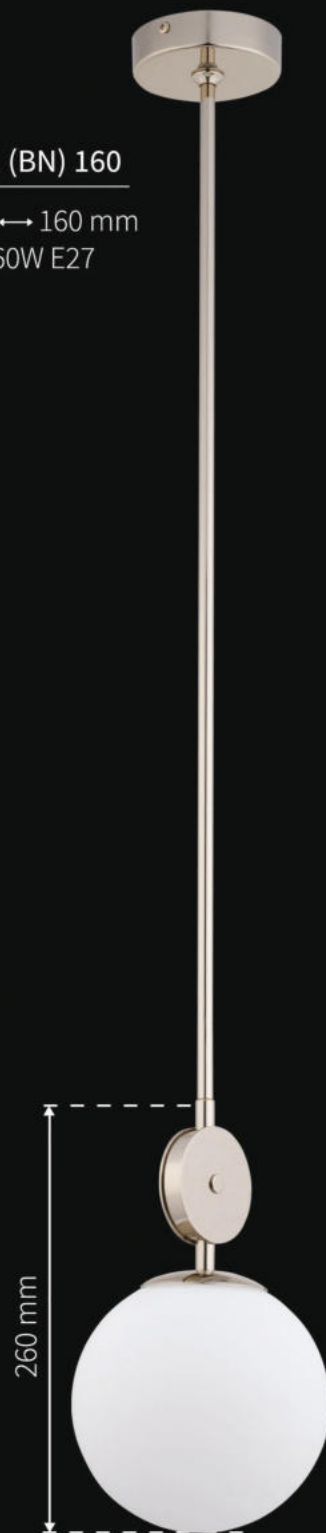



Ellini

(BN)
BŁYSZCZĄCY NIKIEL
SHINY NICKEL
БЛЕСТЯЩИЙ НИКЕЛЬ



(N)
NIKIEL
ANCIENT NICKEL
АНТИЧНЫЙ НИКЕЛЬ



(P)
PATYNA
PATINA
ПАТИНА



(Z)
ZŁOTO
GOLD
ЗОЛОТО



(ZM)
ZŁOTO MATOWE
MATT GOLD
МАТОВОЕ ЗОЛОТО



Ellini

ELL-ZW-10 (N) 450/II

↓ 1100 mm ↔ 450 mm
💡 10 x max 40W E14

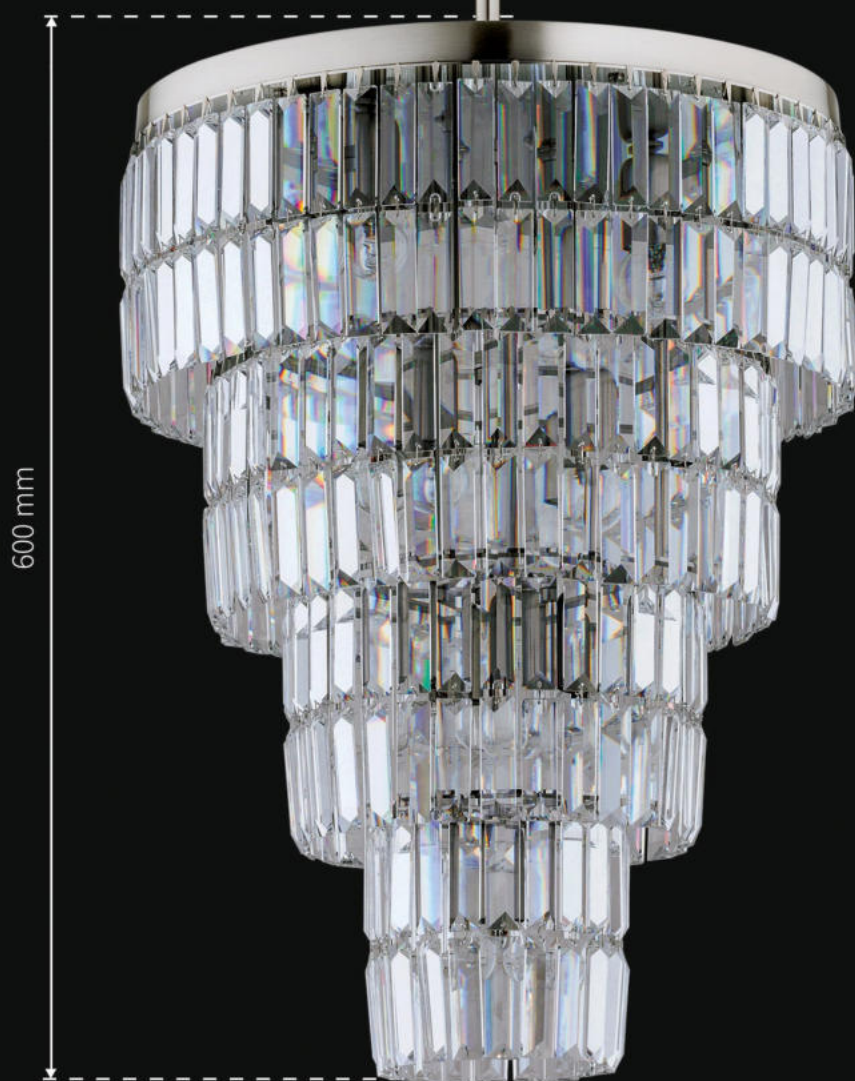

ELL-ZW-3 (Z) 150/V

↓ 1100 mm ↔ 150 mm
💡 3 x max 40W E14



Ellini

ELL-ZW-10 (Z) 250/II

↑ 850 mm ↔ 250 mm
💡 10 x max 40W E14



ELL-ZW-10 (BN) 350/II

↑ 850 mm ↔ 350 mm
💡 10 x max 40W E14



ELL-PLM-10 (BN) 350/II

↑ 600 mm ↔ 350 mm
💡 10 x max 40W E14

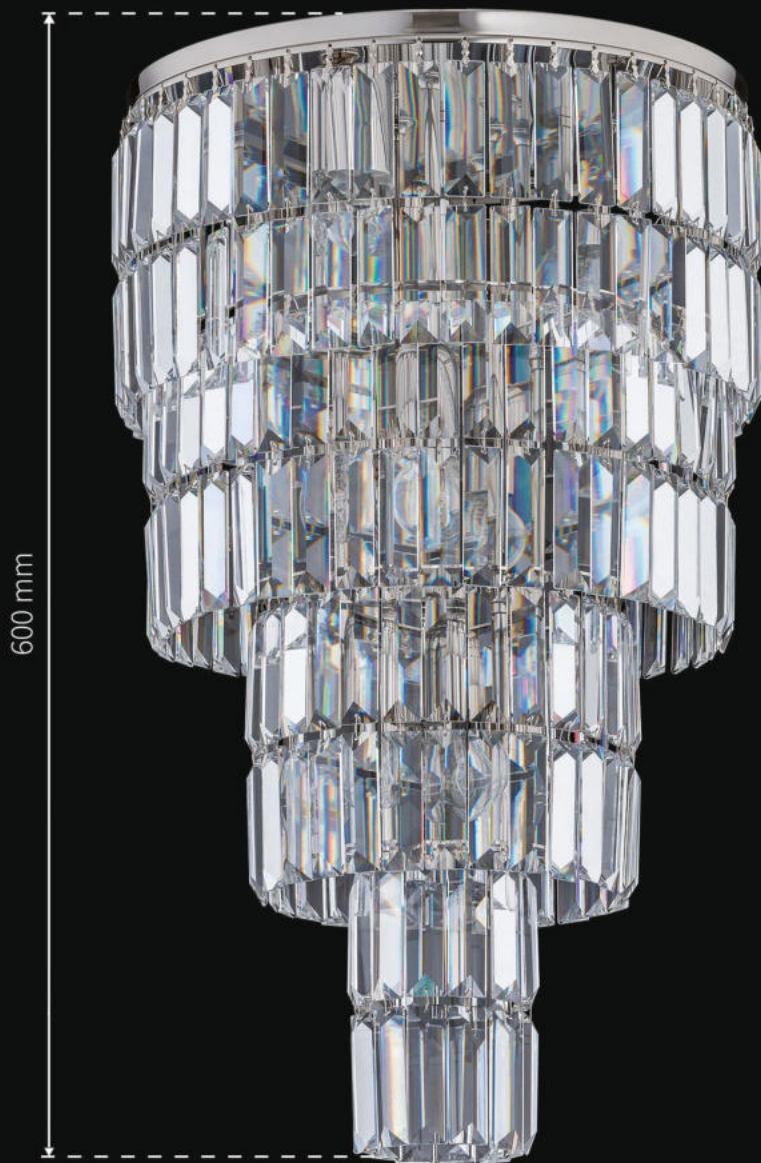

ELL-PLM-10 (Z) 250/II

↑ 600 mm ↔ 250 mm
💡 10 x max 40W E14



Ellini

ELL-PLM-6 (Z) 450/I

↑ 300 mm ↔ 450 mm
⊙ 6 x max 40W E14



300 mm

ELL-PLM-10 (N) 450/II

↑ 600 mm ↔ 450 mm
⊙ 10 x max 40W E14



600 mm

Ellini

ELL-K-1 (P) 100/III

↓ 300 mm ↔ 105 mm → 160 mm
💡 1 x max 40W E14



ELL-OCZ-1 (N) 105/II

↓ 180 mm ↔ 105 mm
💡 1 x max 60W E27



Elve

(BN)
BŁYSZCZĄCY NIKIEL
SHINY NICKEL
БЛЕСТЯЩИЙ НИКЕЛЬ



(N)
NIKIEL
ANCIENT NICKEL
АНТИЧНЫЙ НИКЕЛЬ



(P)
PATYNA
PATINA
ПАТИНА



(Z)
ZŁOTO
GOLD
ЗОЛОТО



(ZM)
ZŁOTO MATOWE
MATT GOLD
МАТОВОЕ ЗОЛОТО



Elve



ELV-PODS-1 (Z) 380 DL

↑ 380 mm ↔ 310 mm
💡 24 V - 4,8 W - 700 lm - 3000 K



ELV-PODS-1 (P) 380 KR

↑ 250 mm ↔ 310 mm
💡 24 V - 4,8 W - 700 lm - 3000 K



ELV-PODS-1 (Z) 250 KR

↑ 250 mm ↔ 120 mm
💡 12 V dc - 3,6 W - 580 lm - 3000 K



ELV-PODS-1 (P) 250 KR

↑ 250 mm ↔ 120 mm
💡 12 V dc - 3,6 W - 580 lm - 3000 K

Elve



ELV-PODS-1 (Z) 380-KR

↑ 380 mm ↔ 310 mm

💡 24 V - 4,8 W - 700 lm - 3000 K



ELV-PODS-1 (P) 380 DL

↑ 380 mm ↔ 310 mm

💡 24 V - 4,8 W - 700 lm - 3000 K



ELV-PODS-1 (N) 380 KR

↑ 380 mm ↔ 310 mm

💡 24 V - 4,8 W - 700 lm - 3000 K



ELV-PODS-1 (N) 380 DL

↑ 380 mm ↔ 310 mm

💡 24 V - 4,8 W - 700 lm - 3000 K



Erba

(1) CZARNY
BLACK
ЧЕРНЫЙ



(2) CIEMNOSZARY
DARK GREY
ТЕМНО-СЕРЫЙ

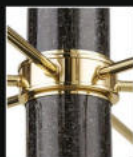

(3) JASNOSZARY
LIGHT GRAY
СВЕТЛО-СЕРЫЙ



(4) BRĄZOWY
BROWN
КОРИЧНЕВЫЙ



(5) ZIELONY
GREEN
ЗЕЛЕНЫЙ



(6) BEŻOWY
BEIGE
БЕЖЕВЫЙ

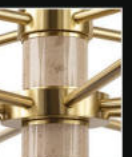

(BN) BŁYSZCZĄCY NIKIEL
SHINY NICKEL
БЛЕСТЯЩИЙ НИКЕЛЬ



(N) NIKIEL
ANCIENT NICKEL
АНТИЧНЫЙ НИКЕЛЬ



(P) PATYNA
PATINA
ПАТИНА



(Z) ZŁOTO
GOLD
ЗОЛОТО



(ZM) ZŁOTO MATOWE
MATT GOLD
МАТОВОЕ ЗОЛОТО



Erba

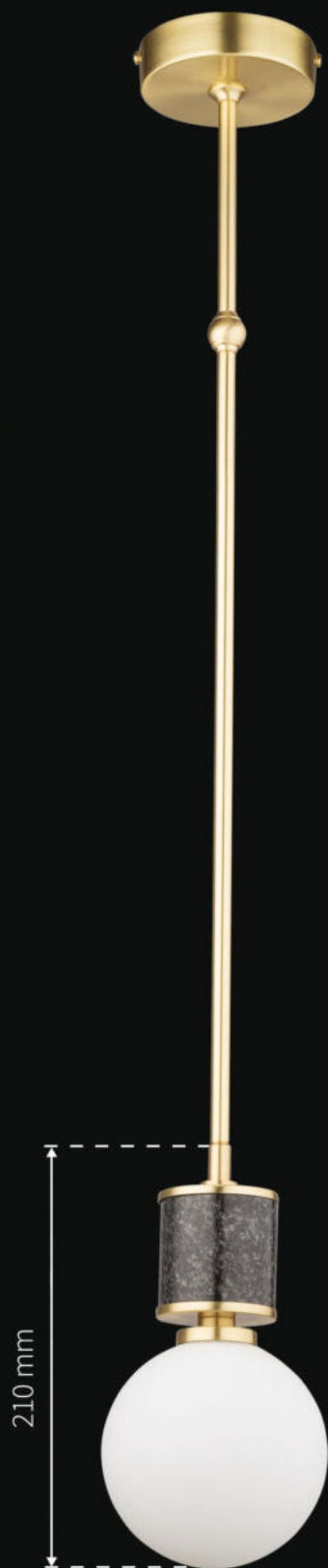

ERB-ZW-1 (ZM/2) B

↑ 700 mm ↔ 120 mm
⊙ 1 x G9 max 5W

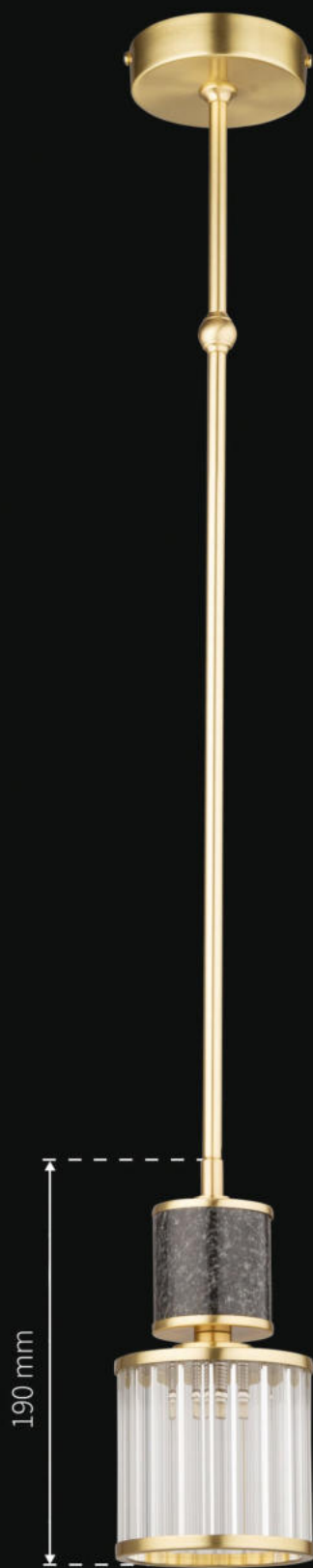

ERB-ZW-1 (ZM/2) T

↑ 700 mm ↔ 100 mm
⊙ 1 x G9 max 5W



ERB-K-2 (Z/1) CB

↑ 240 mm ↔ 120 mm |→ 170 mm
⊙ 1 x G9 max 5W



ERB-K-2 (Z/1) BB

↑ 240 mm ↔ 120 mm |→ 170 mm
⊙ 2 x G9 max 5W

Erba

ERB-ZW-4 (ZM/3) BB

↑ 700 mm ↔ 760 mm

⊙ 8 x G9 max 5W



ERB-ZW-4 (ZM/4) CB

↑ 700 mm ↔ 760 mm

⊙ 4 x G9 max 5W



Erba

ERB-ZW-4 (ZM/5) TT

↑ 700 mm ↔ 740 mm

⊙ 8 x G9 max 5W



ERB-ZW-6 (ZM/3) TT

↑ 700 mm ↔ 740 mm

⊙ 12 x G9 max 5W



Erba

ERB-ZW-6 (ZM/4) BB

↑ 700 mm ↔ 740 mm

⊙ 12 x G9 max 5W



ERB-ZW-6 (ZM/5) CB

↑ 700 mm ↔ 740 mm

⊙ 6 x G9 max 5W



Erba

ERB-ZW-6 (ZM/4) BT

↑ 700 mm ↔ 740 mm

⊙ 12 x G9 max 5W



ERB-ZW-8 (BN/2) BB

↑ 700 mm ↔ 740 mm

⊙ 16 x G9 max 5W



Erba

ERB-ZW-8 (BN/3) BT

↓ 700 mm ↔ 760 mm

⊙ 16 x G9 max 5W



ERB-ZW-8 (BN/4) TT

↓ 700 mm ↔ 740 mm

⊙ 16 x G9 max 5W



Erba

ERB-K-2 (Z/1) TT

↑ 240 mm ↔ 115 mm ↳ 170 mm
⊙ 2 x G9 max 5W



ERB-OCZ -1 (ZM)

↑ 130 mm ↔ 100 mm
⊙ 1 x G9 max 5W



ERB-ZW-8+4 (ZM/6) TT

↑ 1000 mm ↔ 1200 mm
⊙ 24 x G9 max 5W





Fellino

(BN)
 BŁYSZCZĄCY NIKIEL
 SHINY NICKEL
 БЛЕСТЯЩИЙ НИКЕЛЬ



(N)
 NIKIEL
 ANCIENT NICKEL
 АНТИЧНЫЙ НИКЕЛЬ



(P)
 PĄTYNA
 PATINA
 ПАТИНА



(Z)
 ŻŁOTO
 GOLD
 ЗОЛОТО



(ZM)
 ŻŁOTO MATOWE
 MATT GOLD
 МАТОВОЕ ЗОЛОТО



Fellino

FEL-ZW-8 (BN/A)

↓ 700 mm ↔ 940 mm

💡 8 x max 40W E14



FEL-ZW-6 (N/A)

↓ 700 mm ↔ 740 mm

💡 6 x max 40W E14



Fellino



FEL-LG-1 (BN/A)

↑ 690 mm ↔ 300 mm
💡 1 x max 60W E27



FEL-ZW-15 (P/A)

↑ 700 mm ↔ 940 mm
💡 15 x max 40W E14



560 mm

Fellino

FEL-ZW-10 (P/A)

↑ min. 700 mm ↔ 940 mm

💡 10 x max 40W E14



FEL-K-1 (ZM/A)

↑ 315 mm ↔ 150 mm ↳ 230 mm

💡 1 x max 40W E14



FEL-K-1 (ZM/A)

↑ 315 mm ↔ 150 mm ↳ 230 mm

💡 1 x max 40W E14

Fellino



FEL-LS-1 (Z/A)

↑ 1860 mm ↔ 450 mm
💡 1 x max 60W E27

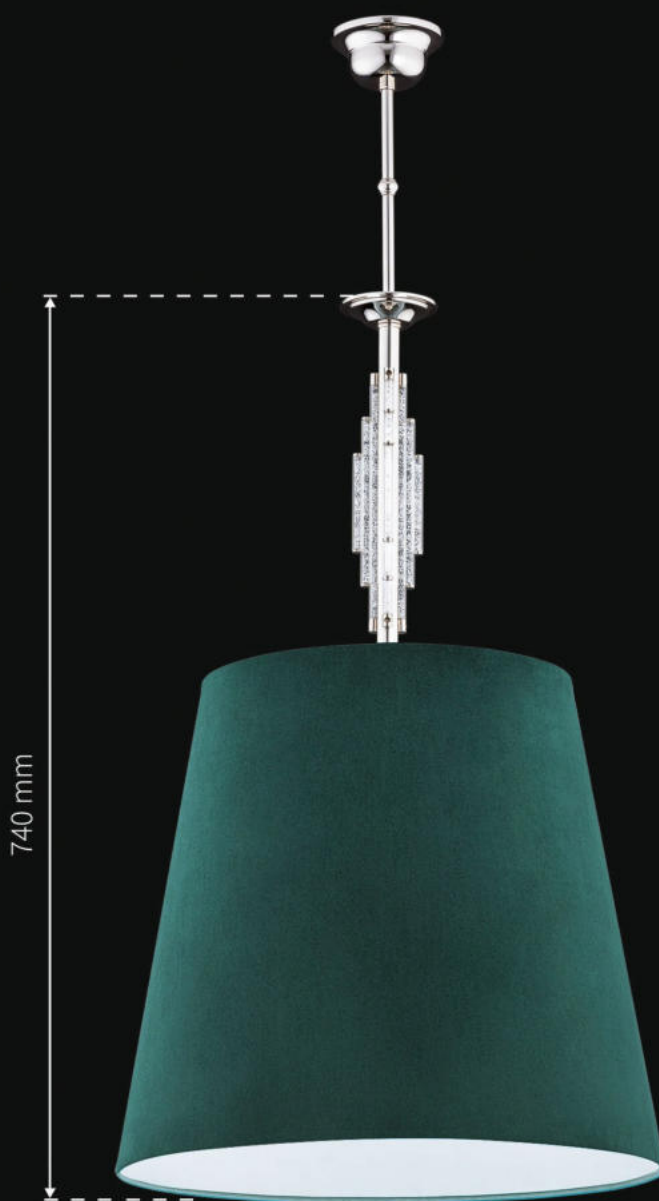

FEL-ZWD-1 (BN/A)

↑ min. 1000 mm ↔ 450 mm
💡 1 x max 60W E27

Fellino

FEL-ZWL-4 (P/A) KR

↑ 700 mm ↔ 850 mm

💡 4 x max 40W E14

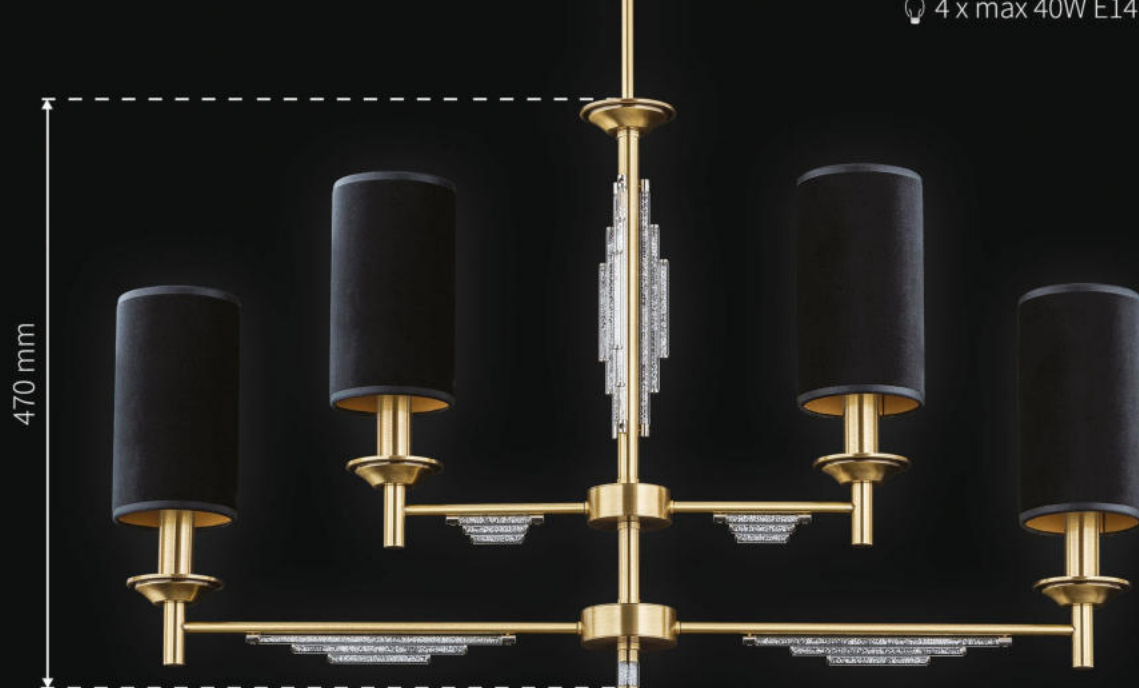

FEL-ZWL-4 (P/A) DL

↑ 700 mm ↔ 1220 mm

💡 4 x max 40W E14

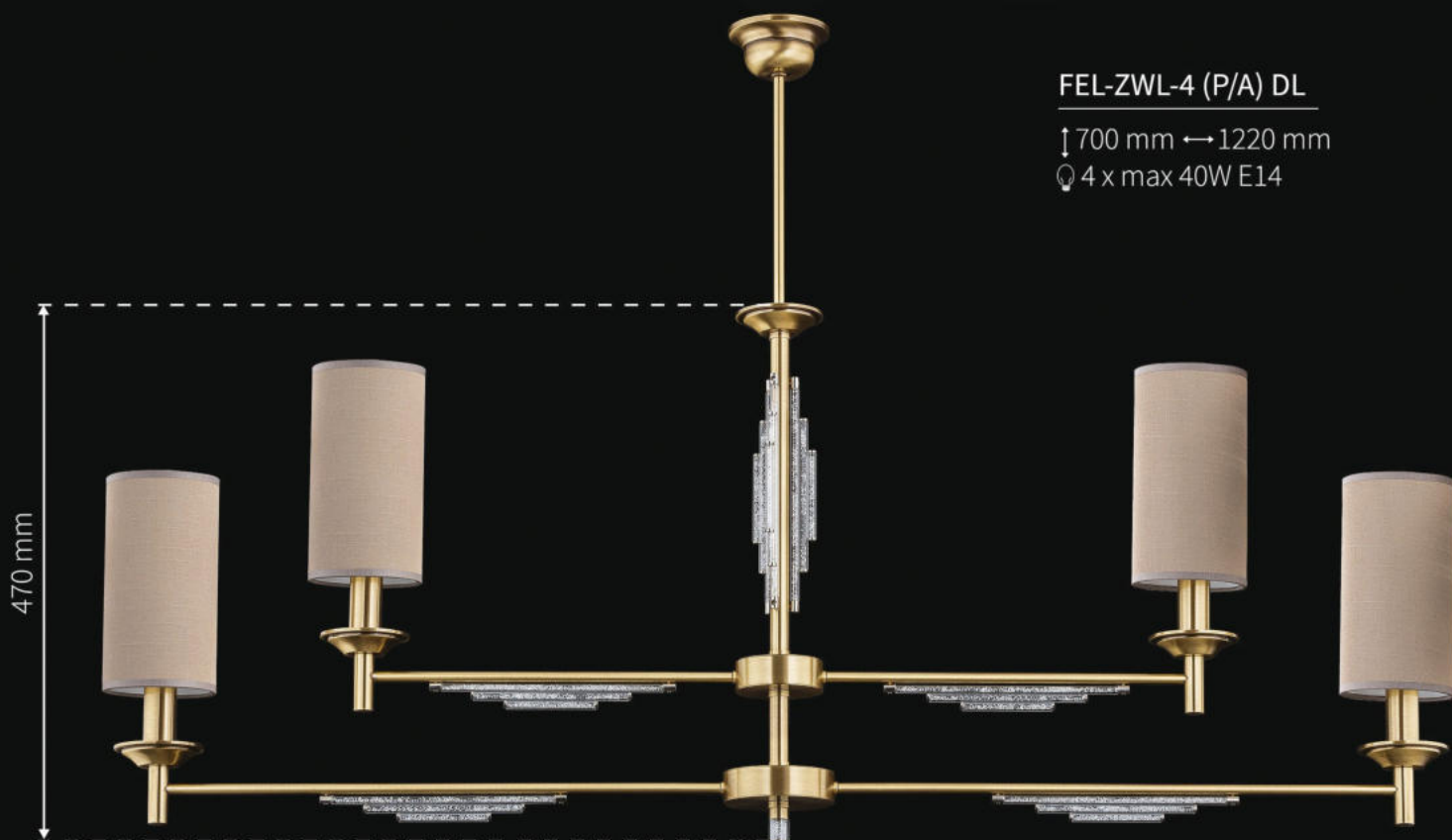

ZWL - ŻYRANDOL W FORMIE LINII / CHANDELIER IN THE FORM OF THE LINE / ЛЮСТРА В ФОРМЕ ЛИНИИ
A - ABAŻURY / LAMP SHADES / АБАЖУРЫ

KR - KRÓTKI / SHORT / КОРОТКАЯ
DL - DŁUGI / LONG / ДЛИННАЯ

Fellino

FEL-ZWL-6 (P/A)

↑ 700 mm ↔ 1220 mm

⊙ 6 x max 40W E14

580 mm



FEL-ZW-21 (P/A)

↑ 1000 mm ↔ 1060 mm

⊙ 21 x max 40W E14

720 mm



ZWL - ŻYRANDOL W FORMIE LINII / CHANDELIER IN
THE FORM OF THE LINE / ЛЮСТРА В ФОРМЕ ЛИНИИ

ZW - ŻYRANDOL / CHANDELIER / ЛЮСТРА
A - ABAŻURY / LAMP SHADES / АБАЖУРЫ



Filago

(BN)
BŁYSZCZĄCY NIKIEL
SHINY NICKEL
БЛЕСТЯЩИЙ НИКЕЛЬ



(N)
NIKIEL
ANCIENT NICKEL
АНТИЧНЫЙ НИКЕЛЬ



(P)
PATYNA
PATINA
ПАТИНА



(Z)
ZŁOTO
GOLD
ЗОЛОТО



(ZM)
ZŁOTO MATOWE
MATT GOLD
МАТОВОЕ ЗОЛОТО



Filago

FIL-ZW-13 (P) 600/500

↓ 1800 mm ↔ 600 mm

💡 13 x max 40W E14

1650 mm



Filago

FIL-ZW-10 (P) 450/270

↓ 950 mm ↔ 450 mm
💡 10 x max 40W E14



FIL-ZW-10 (BN) 250/270

↓ 950 mm ↔ 250 mm
💡 10 x max 40W E14



Filago

FIL-ZW-10 (P) 350/270

↑ 950 mm ↔ 350 mm

💡 10 x max 40W E14



FIL-ZW-3 (Z) 150/500

↑ 800 mm ↔ 150 mm

💡 3 x max 40W E14



Filago



FIL-OCZ-1 (Z) 105/120

↓ 160 mm ↔ 105 mm
💡 1 x max 60W E27



FIL-K-1 (BN) 100/170

↓ 300 mm ↔ 100 mm ↗ 150 mm
💡 1 x max 40W E14



FIL-K-1(Z) 100/270

↓ 460 mm ↔ 100 mm ↗ 270 mm
💡 1 x max 40W E14



FIL-K-2 (Z) 130/500

↓ 680 mm ↔ 140 mm ↗ 180 mm
💡 2 x max 40W E14

Filago



FIL-PLM-10 (P) 350/270

↑ 750 mm ↔ 350 mm
💡 10 x max 40W E14



FIL-PLM-10 (BN) 250/270

↑ 750 mm ↔ 250 mm
💡 10 x max 40W E14

Filago



1650 mm

FIL-PLM-10 (P) 600/500

↑ 1650 mm ↔ 600 mm
💡 10 x max 40W E14



750 mm

FIL-PLM-10 (P) 450/270

↓ 750 mm ↔ 450 mm
💡 10 x max 40W E14

Filago

FIL-ZW-10+ 8 (ZM) 300/170

↑ 1000 mm ↔ 700 mm

💡 18 x max 40W E14

750 mm





Fiore

(ZM)
ZŁOTO MATOWE
MATT GOLD
МАТОВОЕ ЗОЛОТО



(N)
NIKIEL
ANCIENT NICKEL
АНТИЧНЫЙ НИКЕЛЬ



(P)
PATYNA
PATINA
ПАТИНА



Fiore



FIO-PLM-4 (N)

↓ 410 mm ↔ 340 mm

💡 4 x max 40W E14



FIO-ZW-3+1 (P)

↓ 700 mm ↔ 500 mm

💡 4 x max 60W E27

570 mm



540 mm



FIO-ZWD-1 (P)

↓ 650 mm ↔ 340 mm

💡 4 x max 40W E14

Fiore

FIO-LG-1 (P)

↑ 470 mm ↔ 160 mm
💡 1 x max 60W E27



FIO-ZW-6+1 (P)

↑ min. 850 mm ↔ 600 mm
💡 7 x max 60W E27

Fiore



FIO-ZW-1 (P) 150

↑ 700 mm ↔ 150 mm
💡 1 x max 60W E27



FIO-LS-3 (P)

↑ 1660 mm ↔ 500 mm
💡 3 x max 60W E27



FIO-ZW-1 (P) 110

↑ 700 mm ↔ 110 mm
💡 1 x max 60W E27



240 mm



240 mm

Fiore

FIO-K-1 (P)

↑ 330 mm ↔ 110 mm ↳ 270 mm
💡 1 x max 60W E27



FIO-ZW-8+1 (P)

↑ min. 900 mm ↔ 800 mm
💡 9 x max 60W E27

Fiore

FIO-PL-9 (P) 600/270

↑ 820 mm ↔ 600 mm

💡 9 x max 40W E14





Genova

(BN)
BŁYSZCZĄCY NIKIEL
SHINY NICKEL
БЛЕСТЯЩИЙ НИКЕЛЬ



(N)
NIKIEL
ANCIENT NICKEL
АНТИЧНЫЙ НИКЕЛЬ



(P)
PATYNA
PATINA
ПАТИНА



(Z)
ZŁOTO
GOLD
ЗОЛОТО



(ZM)
ZŁOTO MATOWE
MATT GOLD
МАТОВОЕ ЗОЛОТО



Genova



GEN-LG-1 (ZM/A)

↑ 670 mm ↔ 300 mm

💡 1 x max 60W E27



GEN-ZW-6 (P/A)

↑ 700 mm ↔ 780 mm

💡 6 x max 40W E14



350 mm

Genova

GEN-K-1 (ZM/A)

↑ 395 mm ↔ 125 mm ↳ 180 mm

💡 1 x max 40W E14



GEN-ZW-8 (P/A)

↑ 700 mm ↔ 820 mm

💡 8 x max 40W E14

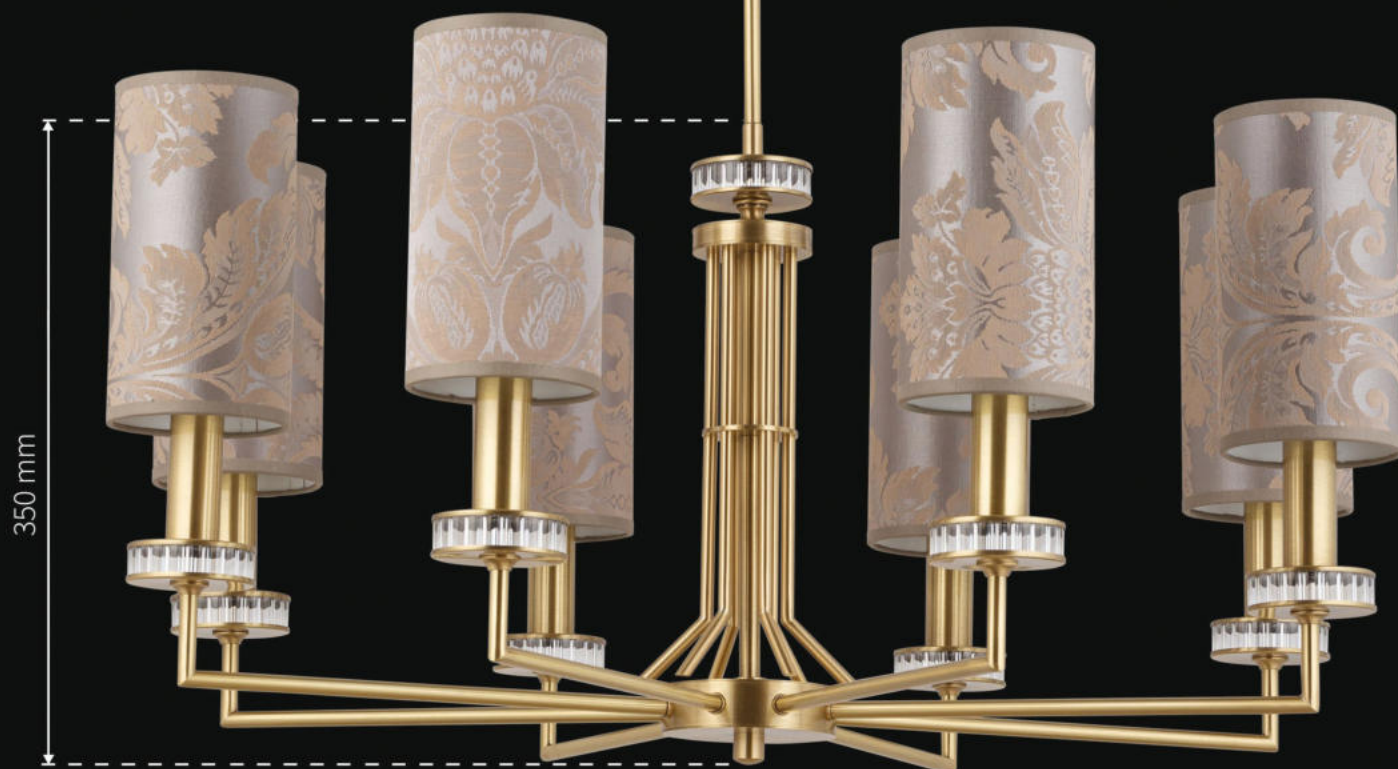

Genova

GEN-ZW-3 (P/A)

↑ 740 mm ↔ 640 mm

💡 3 x max 40W E14

350 mm

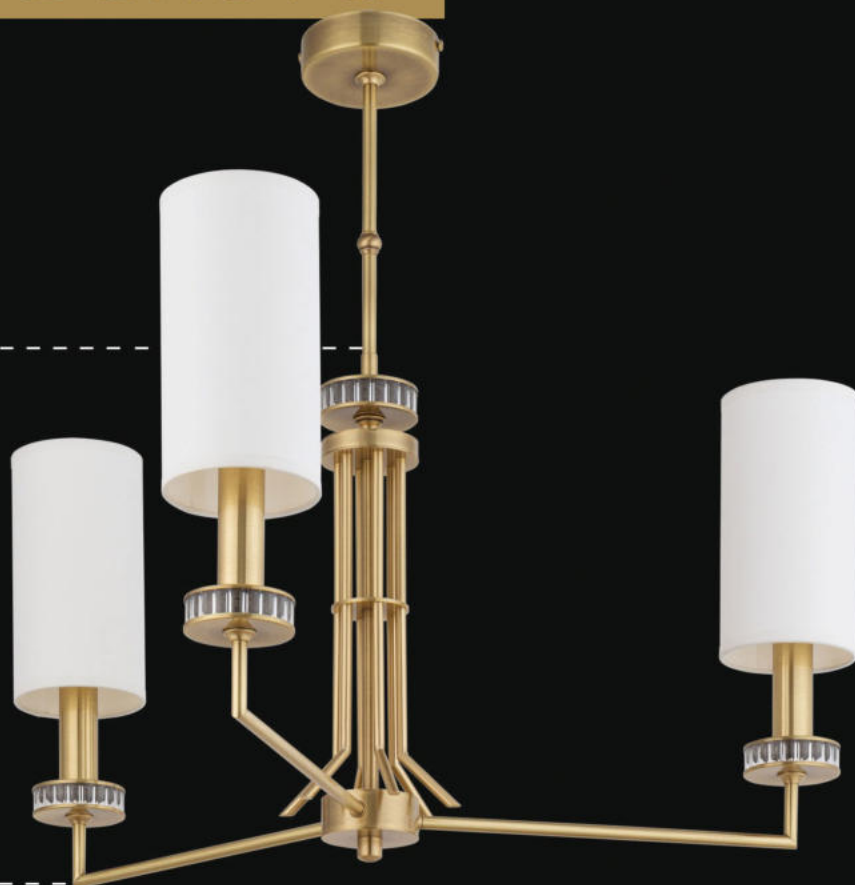

GEN-ZW-8 (N/A)

↑ 700 mm ↔ 820 mm

💡 8 x max 40W E14

350 mm



Genova

GEN-ZW-8+4 (P/A)

↓ 900 mm ↔ 820 mm

💡 12 x max 40W E14



600 mm



Impla

(BN)
BŁYSZCZĄCY NIKIEL
SHINY NICKEL
БЛЕСТЯЩИЙ НИКЕЛЬ



(N)
NIKIEL
ANCIENT NICKEL
АНТИЧНЫЙ НИКЕЛЬ



(P)
PATYNA
PATINA
ПАТИНА



(Z)
ZŁOTO
GOLD
ЗОЛОТО



(ZM)
ZŁOTO MATOWE
MATT GOLD
МАТОВОЕ ЗОЛОТО



Impla

IMP-ZW-6 (P)

↑ 700 mm ↔ 800 mm

💡 6 x max 40W E14



IMP-ZW-8 (Z)

↑ 700 mm ↔ 800 mm

💡 8 x max 40W E14



Impla

IMP-K-1 (P)

↑ 260 mm ↔ 100 mm ↳ 260 mm
💡 1 x max 40W E14



IMP-ZW-12 (ZM)

↑ 700 mm ↔ 1040 mm
💡 12 x max 40W E14



Impla

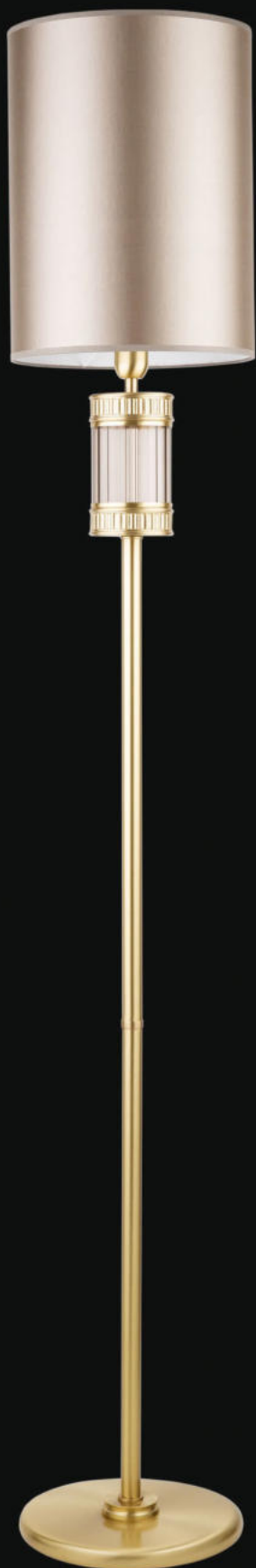

IMP-LS-1 (ZM/A)

↑ 1870 mm ↔ 300 mm
💡 1 x max 60W E27

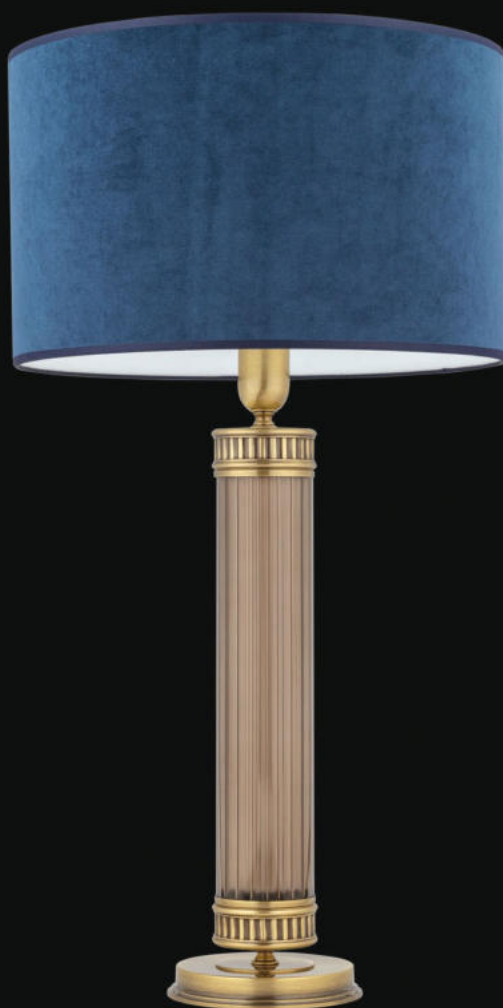

IMP-LG-1 (P/A)

↑ 770 mm ↔ 400 mm
💡 1 x max 60W E27



IMP-ZW-1 (N)

↑ 700 mm ↔ 100 mm
💡 1 x max 40W E14



Izano

(1) CZARNY
BLACK
ЧЕРНЫЙ

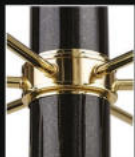

(2) CIEMNOSZARY
DARK GREY
ТЕМНО-СЕРЫЙ



(3) JASNOSZARY
LIGHT GRAY
СВЕТЛО-СЕРЫЙ



(4) BRĄZOWY
BROWN
КОРИЧНЕВЫЙ



(5) ZIELONY
GREEN
ЗЕЛЕНЫЙ



(6) BEŻOWY
BEIGE
БЕЖЕВЫЙ

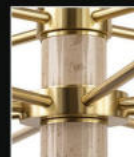

(BN) WYSZCZĄCY NIKIEL
SHINY NICKEL
БЛЕСТЯЩИЙ НИКЕЛЬ



(N) NIKIEL
ANCIENT NICKEL
АНТИЧНЫЙ НИКЕЛЬ



(P) PATYNA
PATINA
ПАТИНА



(Z) ZŁOTO
GOLD
ЗОЛОТО



(ZM) ZŁOTO MATOWE
MATT GOLD
МАТОВОЕ ЗОЛОТО



Izano



IZA-K-1 (P/1) T

↑ 440 mm ↔ 80 mm ↗ 100 mm

⊙ 1 x max 40W E14



IZA-ZW-8 (ZM/5) T

↑ 700 mm ↔ 730 mm

⊙ 8 x max 40W E14



290 mm

Izano



IZA-K-1 (P/1) B

↓ 440 mm ↔ 80 mm ↗ 100 mm
💡 1 x max 40W E14



IZA-ZW-8 (ZM/5) B

↓ 700 mm ↔ 730 mm
💡 8 x max 40W E14



290 mm

Izano

IZA-ZW-6 (BN/3) T

↑ 700 mm ↔ 730 mm

💡 6 x max 40W E14



IZA-ZW-6 (P/6) B

↑ 700 mm ↔ 730 mm

💡 6 x max 40W E14



ZW - ŻYRANDOL / CHANDELIER / ЛЮСТРА
B - BIAŁY KLOSZ / WHITE GLASS / БЕЛОЕ СТЕКЛО

T - TRANSPARENTNY KLOSZ / TRANSPARENT GLASS /
ПРОЗРАЧНЫЙ СТЕКЛЯННЫЙ ПЛАФОН

Izano

IZA-ZW-1(Z/1)T

↓ 700 mm ↔ 100 mm
💡 1 x max 40W E14

570 mm

80 mm

IZA-ZWL-2 (ZM/2)T

↓ 700 mm ↔ 50 - 920 mm
💡 2 x max 40W E14

ZW - ŻYRANDOL / CHANDELIER / ЛЮСТРА
T - TRANSPARENTNY KLOSZ / TRANSPARENT GLASS /
ПРОЗРАЧНЫЙ СТЕКЛЯННЫЙ ПЛАФОН

ZWL - ŻYRANDOL W FORMIE LINII / CHANDELIER IN
THE FORM OF THE LINE / ЛЮСТРА В ФОРМЕ ЛИНИИ

Izano



IZA-LG-1 (BN/2)

↑ 690 mm ↔ 250 mm

💡 1 x max 60W E27



IZA-ZW-8+4 (Z/1)T

↑ 1000 mm ↔ 1200 mm

💡 12 x max 40W E14



LG - LAMPA GABINETOWA / DESK LAMP / КАБИНЕТНАЯ ЛАМПА
ZW - ŻYRANDOL / CHANDELIER / ЛЮСТРА

T - TRANSPARENTNY KLOSZ / TRANSPARENT GLASS /
ПРОЗРАЧНЫЙ СТЕКЛЯННЫЙ ПЛАФОН

Izano

IZA-LG-1 (P/6)

↑ 690 mm ↔ 300 mm
💡 1 x max 60W E27



IZA-ZW-12+6 (P/4) B

↑ 1000 ↔ 1200 mm
💡 18 x max 40W E14



LG - LAMPA GABINETOWA / DESK LAMP / КАБИНЕТНАЯ ЛАМПА

ZW - ŻYRANDOL / CHANDELIER / ЛЮСТРА

Izano



IZA-LG-1(N/3)

↓ 690 mm ↔ 300 mm

⊙ 1 x max 60W E27



IZA-ZW-12+6 (P/4) T

↓ 1000 mm ↔ 1200 mm

⊙ 18 x max 40W E14





Kiara

(N)
NIKIEL
ANCIENT NICKEL
АНТИЧНЫЙ НИКЕЛЬ

(P)
PATYNA
PATINA
ПАТИНА

(ZM)
ZŁOTO MATOWE
MATT GOLD
МАТОВОЕ ЗОЛОТО



Kiara

KIA-K-1 (P)

↓ 220 mm ↔ 180 mm ↳ 310 mm

⊙ 1 x max 40W E14



KIA-ZW-6 (P)

↓ 700 mm ↔ 880 mm

⊙ 9 x max 40W E14



Kiara

KIA-ZW-8 (P)

↓ 700 mm ↔ 880 mm

⊙ 11 x max 40W E14





Lauria

(BN)
BŁYSZCZĄCY NIKIEL
SHINY NICKEL
БЛЕСТЯЩИЙ НИКЕЛЬ



(N)
NIKIEL
ANCIENT NICKEL
АНТИЧНЫЙ НИКЕЛЬ



(P)
PATYNA
PATINA
ПАТИНА



(Z)
ZŁOTO
GOLD
ЗОЛОТО



(ZM)
ZŁOTO MATOWE
MATT GOLD
МАТОВОЕ ЗОЛОТО



Lauria

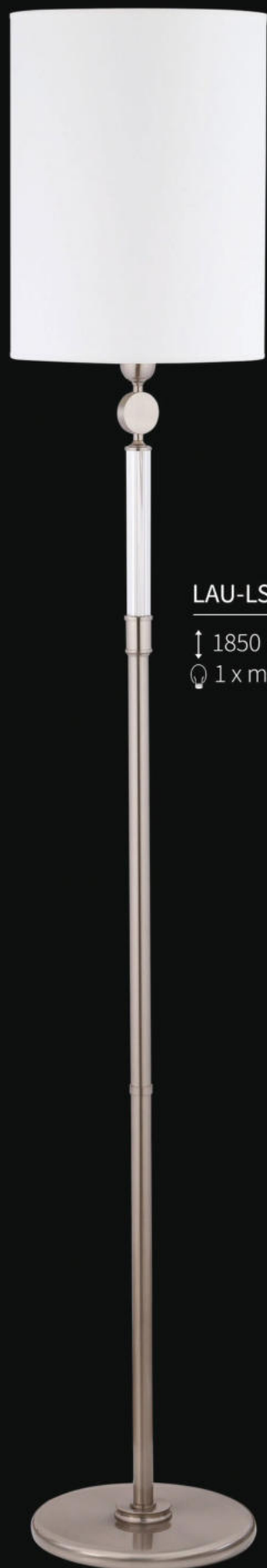

LAU-LS-1 (N/A)

↑ 1850 mm ↔ 300 mm
💡 1 x max 60W E27

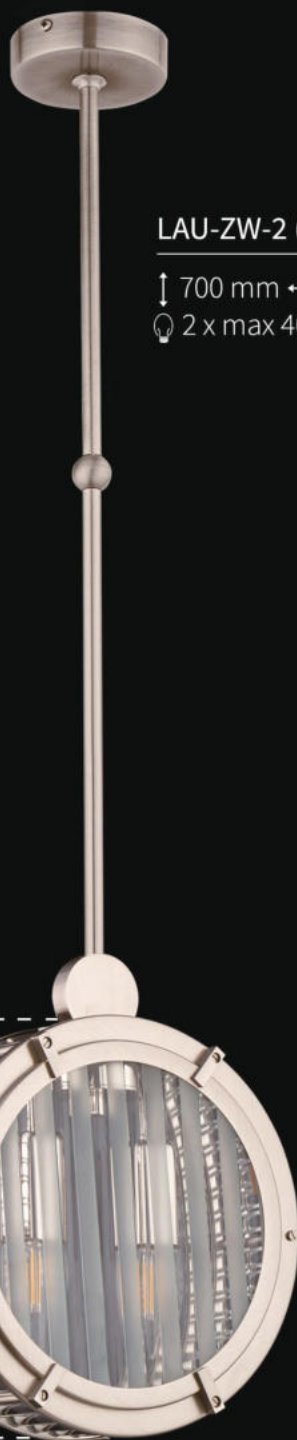

LAU-ZW-2 (N) 240

↑ 700 mm ↔ 240/85 mm
💡 2 x max 40W E14



240 mm



LAU-ZW-2 (Z) 310

↑ 700 mm ↔ 310/85 mm
💡 2 x max 40W E14

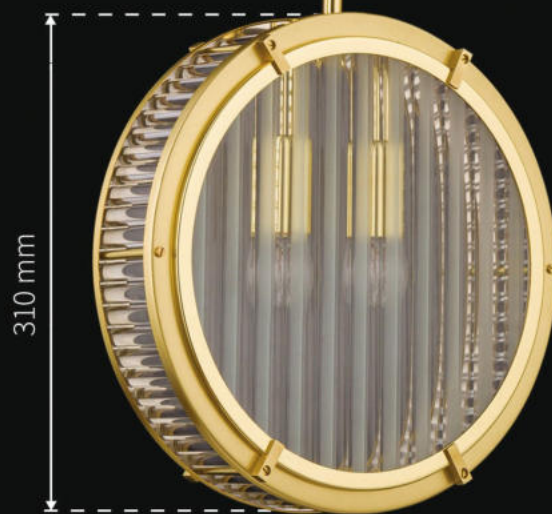

310 mm

Lauria



LAU-K-1 (P)

↓ 255 mm ↔ 100 mm ↳ 160 mm
💡 1 x max 40W E14

LAU-K-2 (Z)

↓ 480 mm ↔ 100 mm ↳ 160 mm
💡 2 x max 40W E14



LAU-LG-2 (Z)

↓ 320 mm ↔ 310/85 mm
💡 2 x max 40W E14





Lavone

(BN)
BŁYSZCZĄCY NIKIEL
SHINY NICKEL
БЛЕЯЩИЙ НИКЕЛЬ



(N)
NIKIEL
ANCIENT NICKEL
АНТИЧНЫЙ НИКЕЛЬ



(P)
PATYNA
PATINA
ПАТИНА



(Z)
ZŁOTO
GOLD
ЗОЛОТО



(ZM)
ZŁOTO MATOWE
MATT GOLD
МАТОВОЕ ЗОЛОТО



Lavone



LAV-LG-2 (P)

↑ 440 mm ↔ 310 mm
💡 2 x max 40W E14



LAV-ZW-6 (P) 440-2

↑ 700 mm ↔ 440 mm
💡 6 x max 40W E14



LAV-ZW-3 (P) 310-1

↑ 700 mm ↔ 310 mm
💡 3 x max 40W E14

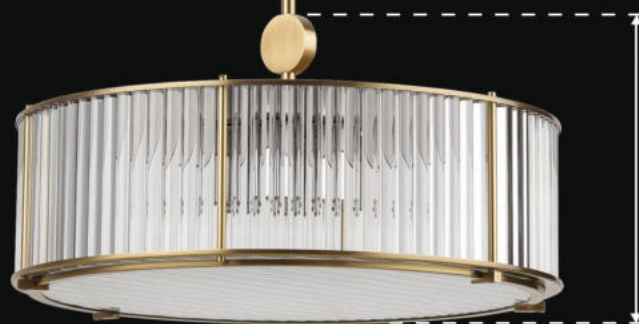

210 mm

Lavone



LAV-ZW-6 (P) 440-1

↓ 700 mm ↔ 440 mm

💡 6 x max 40W E14



LAV-ZWR-6 (ZM) 600-2

↓ 700 mm ↔ 600 mm

💡 6 x max 40W E14

205 mm



150 mm



Lavone

LAV-ZW-10 (ZM) 60/44/31

↑ 700 mm ↔ 600 mm
💡 10 x max 40W E14



LAV-ZWL-6 (ZM) 310

↑ 700 mm ↔ 750/310 mm
💡 6 x max 40W E14

Lavone

LAV-ZW-2 (ZM) 240-1

↓ 700 mm ↔ 240 mm

💡 2 x max 40W E14

LAV-ZWL-6 (Z) 240

↓ 700 mm ↔ 960/240 mm

💡 6 x max 40W E14

150 mm

195 mm

Lavone



LAV-PLM-6 (BN) 600-2

↓ 145 mm ↔ 600 mm
⦿ 6 x max 40W E14

LAV-ZW-6 (P) 600-1

↓ 700 mm ↔ 600 mm
⦿ 6 x max 40W E14



LAV-PLM-6 (P) 600-1

↓ 85 mm ↔ 600 mm
⦿ 6 x max 40W E14



150 mm

Lavone

LAV-PLM-6 (P) 440-2

↑ 145 mm ↔ 440 mm

💡 6 x max 40W E14



LAV-ZWL-9 (P) 310

↑ 700 mm ↔ 1220 \ 310 mm

💡 9 x max 40W E14



Lavone

LAV-PLM-6 (P) 440-1

↓ 85 mm ↔ 440 mm

💡 6 x max 40W E14



LAV-ZWL-18 (ZM) 440

↓ 700 mm ↔ 440 / 1670 mm

💡 18 x max 40W E14



Lavone

LAV-ZWO-6 (ZM) 1000/120

↓ 700 mm ↔ 1000/120 mm
💡 6 x max 40W E14



LAV-ZW-9 (P) 60/44

↓ 700 mm ↔ 600 mm
💡 9 x max 40W E14



LAV-ZWO-6 (ZM) 950/250

↓ 700 mm ↔ 950/250 mm
💡 6 x max 40W E14

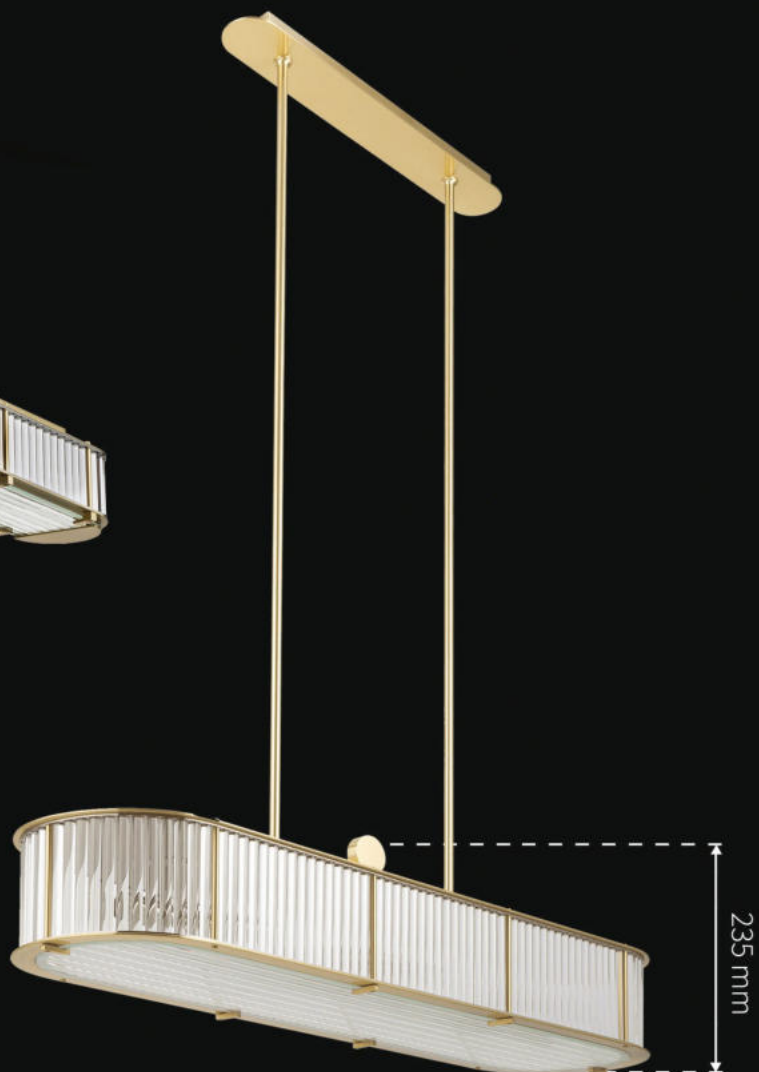



Lea Abazur

(BN)
BŁYSZCZĄCY NIKIEL
SHINY NICKEL
БЛЕСТЯЩИЙ НИКЕЛЬ



(N)
NIKIEL
ANCIENT NICKEL
АНТИЧНЫЙ НИКЕЛЬ



(P)
PATYNA
PATINA
ПАТИНА



(Z)
ZŁOTO
GOLD
ЗОЛОТО



(ZM)
ZŁOTO MATOWE
MATT GOLD
МАТОВОЕ ЗОЛОТО



Lea Abazur

LEA-ZW-12 (BN/A)

↓ 700 mm ↔ 1020 mm
⊙ 12 x max 40W E14



Lea Abazur

LEA-ZW-6 (Z/A)

↑ 700 mm ↔ 720 mm
⊙ 6 x max 40W E14



LEA-ZW-8 (BN/A)

↑ 700 mm ↔ 1020 mm
⊙ 8 x max 40W E14



Lea Abazur

LEA-ZW-4 (BN/A)

↑ 700 mm ↔ 720 mm

⊙ 4 x max 40W E14



LEA-ZW-10 (BN/A)

↑ 700 mm ↔ 1020 mm

⊙ 10 x max 40W E14



Lea Abazur



LEA-K-1 (P/A) CL

↓ 410 mm ↔ 100 mm | → 260 mm
⊙ 1 x max 40W E14



LEA-K-1 (Z/A)

↓ 570 mm ↔ 100 mm | → 180 mm
⊙ 1 x max 40W E14



LEA-LG-1 (Z/A)

↓ 600 mm ↔ 180 mm
⊙ 1 x max 40W E14



LEA-K-2 (Z/A)

↓ 570 mm ↔ 240 mm | → 170 mm
⊙ 2 x max 40W E14

Lea Abazur

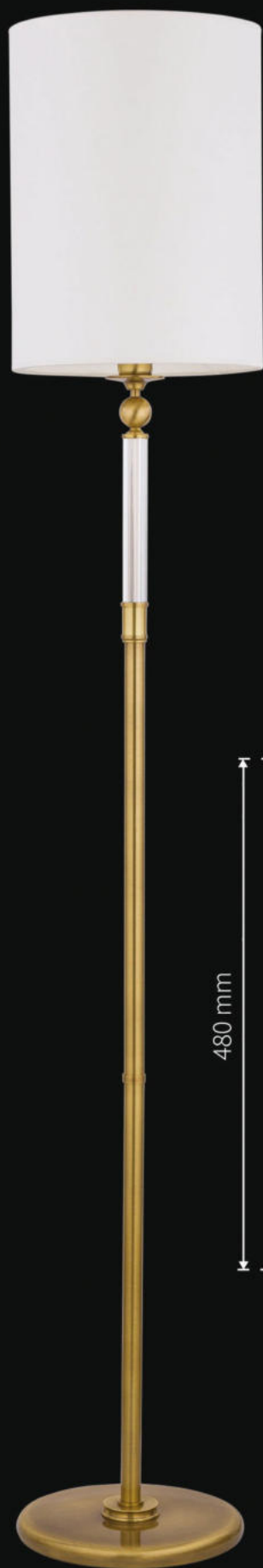

LEA-LS-1 (P/A)

↓ 1800 mm ↔ 450 mm

💡 1 x max 60W E27

480 mm

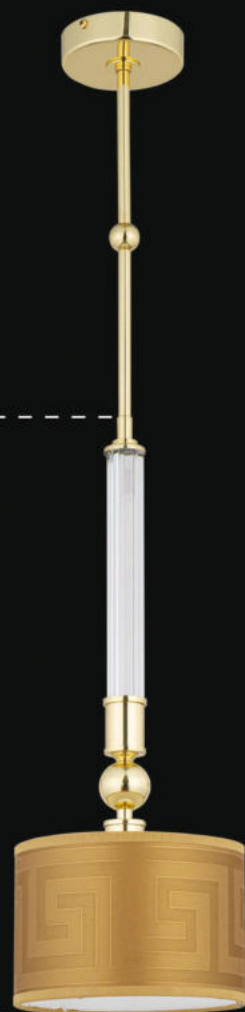

LEA-ZWM-1 (Z/A)

↓ 700 mm ↔ 180 mm

💡 1 x max 40W E14

650 mm



LEA-ZWM-1 (Z/A)

↓ 900 mm ↔ 180 mm

💡 1 x max 40W E14

540 mm



LEA-ZWM-1 (BN/A)

↓ 700 mm ↔ 100 mm

💡 1 x max 40W E14



Lea Klosz

(BN)
BŁYSZCZĄCY NIKIEL
SHINY NICKEL
БЛЕСТЯЩИЙ НИКЕЛЬ



(N)
NIKIEL
ANCIENT NICKEL
АНТИЧНЫЙ НИКЕЛЬ



(P)
PATYNA
PATINA
ПАТИНА



(Z)
ZŁOTO
GOLD
ЗОЛОТО



(ZM)
ZŁOTO MATOWE
MATT GOLD
МАТОВОЕ ЗОЛОТО



Lea Klosz

LEA-ZWM-1 (BN)

↑ 700 mm ↔ 100 mm
⊙ 1 x max 40W E14



LEA-ZW-12 (BN)

↑ 700 mm ↔ 1020 mm
⊙ 12 x max 40W E14



Lea Klosz



LEA-K-2 (Z)

↑ 570 mm ↔ 240 mm ↗ 170 mm
⊙ 2 x max 40W E14

LEA-K-1 (P)

↑ 570 mm ↔ 100 mm ↗ 180 mm
⊙ 1 x max 40W E14



LEA-ZW-6 (Z)

↑ 700 mm ↔ 720 mm
⊙ 6 x max 40W E14





Lido

(N)
NIKIEL
ANCIENT NICKEL
АНТИЧНЫЙ НИКЕЛЬ



(P)
РАТУНА
PATINA
ПАТИНА



Lido

LID-ZW-3 (P)

↑ 700 mm ↔ 690 mm

💡 3 x max 60W E27



LID-ZW-5 (P)

↑ 700 mm ↔ 690 mm

💡 5 x max 60W E27



LID-ZW-1 (P)

↑ 700 mm ↔ 340 mm

💡 1 x max 60W E27



Lido

LID-ZW-5 (N)

↑ 700 mm ↔ 690 mm

💡 5 x max 60W E27



LID-LG-1 (P)

↑ 430 mm ↔ 290 mm

💡 1 x max 60W E27



LID-PL-2 (P)

↑ 200 mm ↔ 340 mm

💡 2 x max 60W E27

Lido

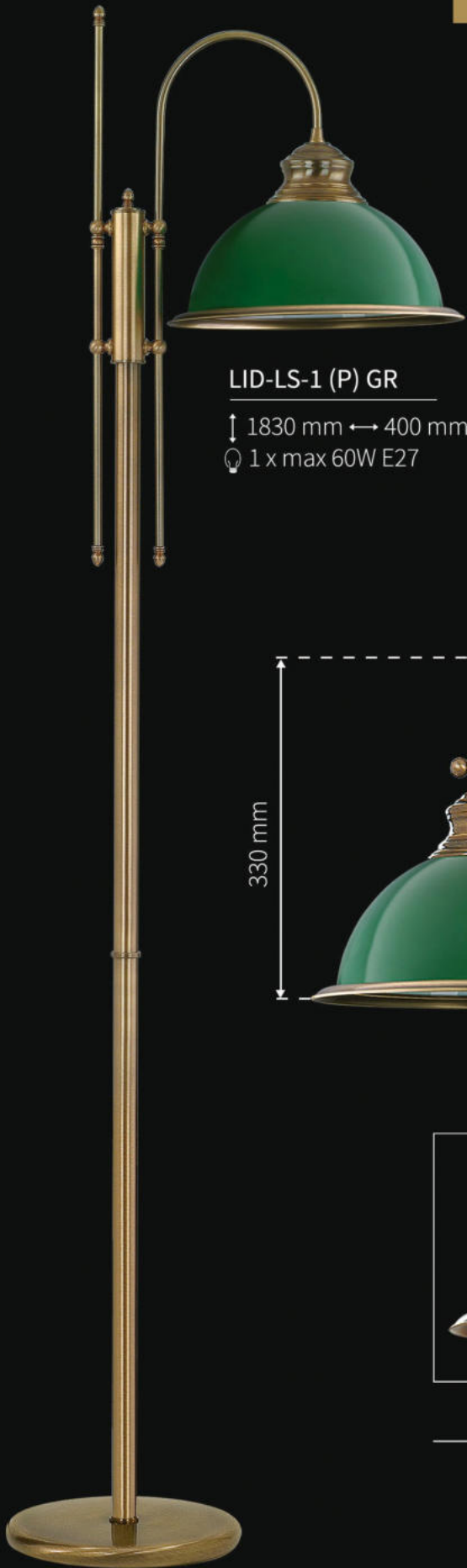

LID-LS-1 (P) GR

↑ 1830 mm ↔ 400 mm
💡 1 x max 60W E27



LID-ZW-2 (P) GR

↑ 1000 mm ↔ 880/340 mm
💡 2 x max 60W E27

330 mm



WHITE / БЕЛЫЙ

GR- GREEN / ЗЕЛЕНЬ

Lido



LID-K-1 (P) GR

↓ 310 mm ↔ 240 mm |→ 330 mm
💡 1 x max 60W E27



LID-LG-1 (P) GR

↓ 430 mm ↔ 290 mm
💡 1 x max 60W E27



LID-ZWL-3 (P) GR

↓ 1000 mm ↔ 1400/340 mm
💡 3 x max 60W E27



330 mm





Loretto

(BN)
BŁYSZCZĄCY NIKIEL
SHINY NICKEL
БЛЕСТЯЩИЙ НИКЕЛЬ



(N)
NIKIEL
ANCIENT NICKEL
АНТИЧНЫЙ НИКЕЛЬ



(P)
PATYNA
PATINA
ПАТИНА



(Z)
ZŁOTO
GOLD
ЗОЛОТО



(ZM)
ZŁOTO MATOWE
MATT GOLD
МАТОВОЕ ЗОЛОТО



Loretto

LOR-ZW-2 (P) 120

↓ 1000 mm ↔ 130 mm
💡 2 x max 40W E14

500 mm



LOR-K-2 (BN)

↓ 540 mm ↔ 100 mm ↳ 120
💡 2 x max 40W E14

LOR-LG-2 (P)

↓ 465 mm ↔ 160 mm
💡 2 x max 40W E14

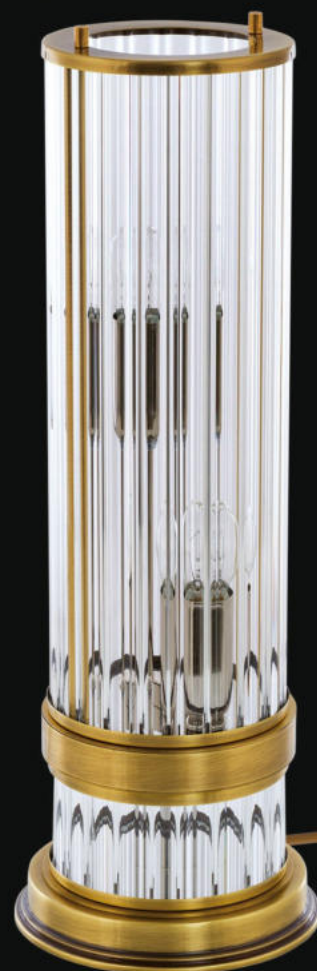

Loretto

LOR-ZW-2 (N) 120

↓ 1000 mm ↔ 130 mm
💡 2 x max 40W E14



LOR-ZW-2 (Z) 120

↓ 1000 mm ↔ 240/85 mm
💡 2 x max 40W E14





Luca

(N)
NIKIEL
ANCIENT NICKEL
АНТИЧНЫЙ НИКЕЛЬ

(P)
PATINA
PATINA
ПАТИНА



Luca

LUC-ZW-24 (N/A)

↑ min. 1150 mm ↔ 1300 mm

⊙ 24 x max 40W E14



LUC-K-2 (P/A)

↑ 370 mm ↔ 380 mm ↳ 280

⊙ 2 x max 40W E14



Luca

LUC-LS-3 (P/A)

↑ 1720 mm ↔ 530 mm
💡 3 x max 40W E14

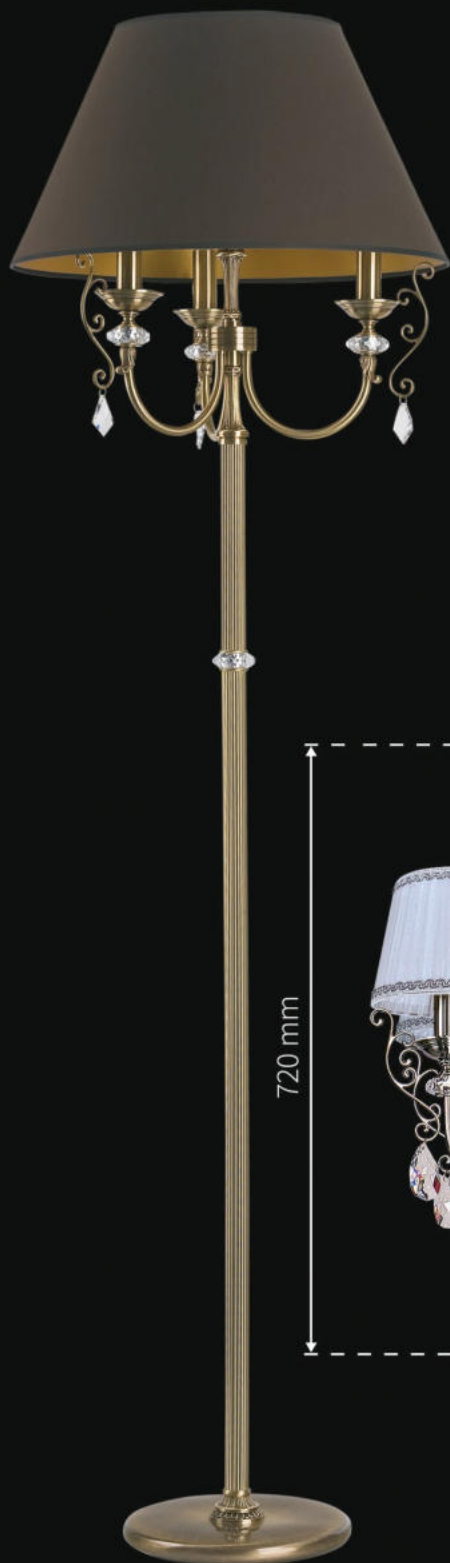

LUC-K-1 (N/A)

↑ 350 mm ↔ 180 mm ↳ 300 mm
💡 1 x max 40W E14



LUC-ZW-12 (N/A)

↑ 800 mm ↔ 1300 mm
💡 12 x max 40W E14

Luca

LUC-ZW-8 (P/A)

↓ 800 mm ↔ 1100 mm

⊙ 8 x max 40W E14



LUC-ZW-6 (P/A)

↓ 800 mm ↔ 950 mm

⊙ 6 x max 40W E14





Meleze

(BN)
BŁYSZCZĄCY NIKIEL
SHINY NICKEL
БЛЕСТЯЩИЙ НИКЕЛЬ



(N)
NIKIEL
ANCIENT NICKEL
АНТИЧНЫЙ НИКЕЛЬ



(P)
PATYNA
PATINA
ПАТИНА



(Z)
ZŁOTO
GOLD
ЗОЛОТО



(ZM)
ZŁOTO MATOWE
MATT GOLD
МАТОВОЕ ЗОЛОТО



Meleze

MEL-ZW-1 (P)

↓ 700 mm ↔ 120 mm

💡 1 x G9 max 5W

480 mm

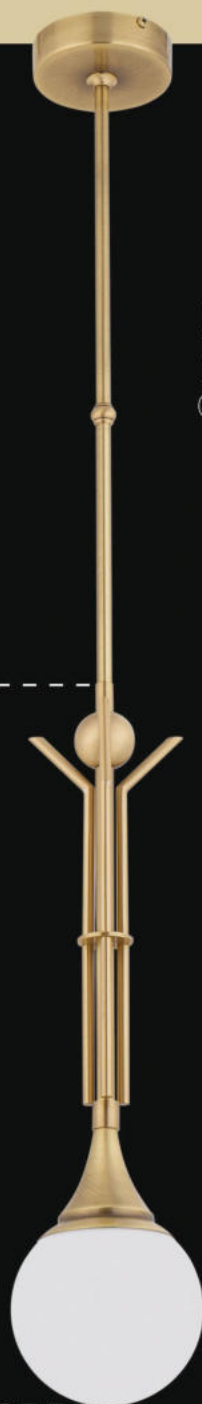

MEL-ZW-6 (P)

↓ 700 mm ↔ 710 mm

💡 6 x G9 max 5W

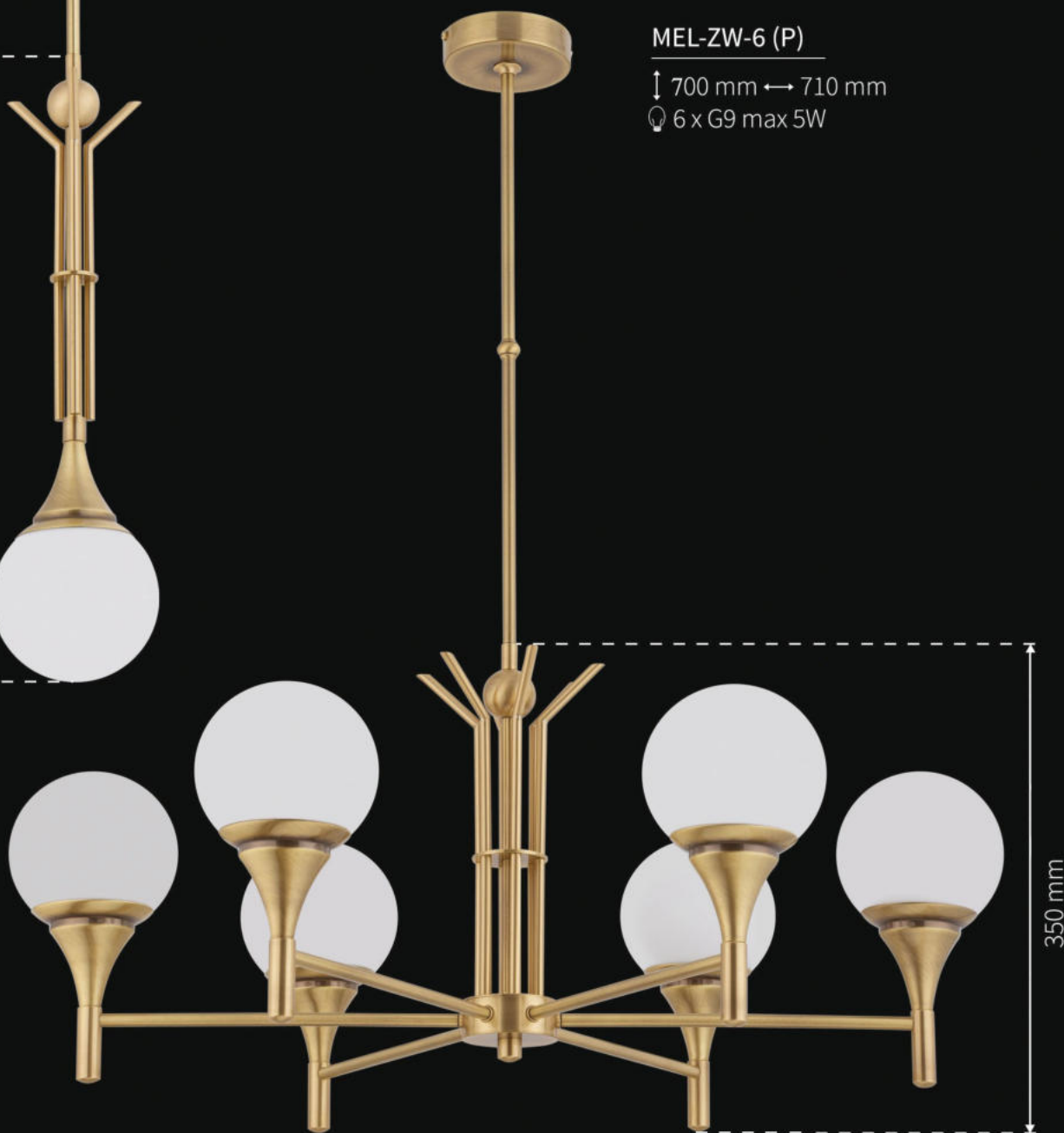

350 mm

Meleze

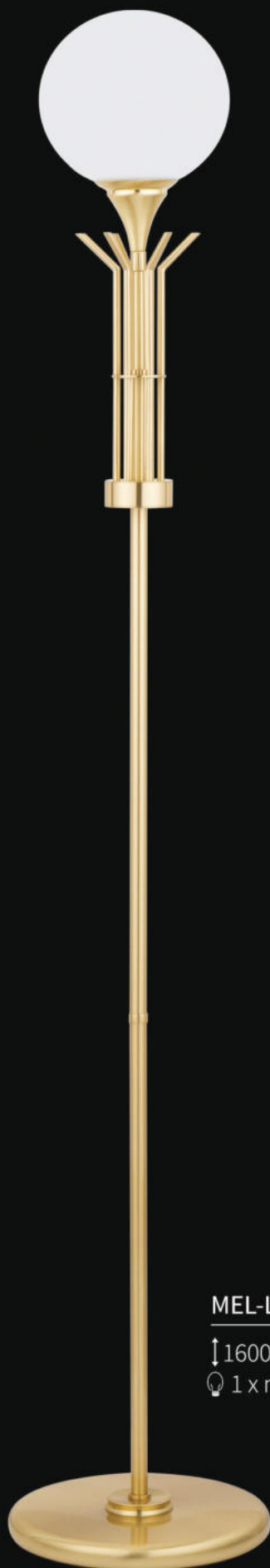

MEL-LS-1 (ZM)

↑ 1600 mm ↔ 280 mm
💡 1 x max 60W E27



MEL-LG-1 (P)

↑ 510 mm ↔ 130 mm
💡 1 x G9 max 5W



MEL-ZW-3 (Z)

↑ 700 mm ↔ 550 mm
💡 3 x G9 max 5W



Meleze

MEL-ZW-8+4 (ZM)

↓ 900 mm ↔ 800 mm

💡 12 x G9 max 5W



Meleze



MEL-K-1(P)

↓ 260 mm ↔ 120 mm |→ 140 mm

💡 1 x max 40W E14



MEL-ZW-8 (P)

↓ 700 mm ↔ 800 mm

💡 8 x G9 max 5W





Merano Abazur

(BN)
BŁYSZCZĄCY NIKIEL
SHINY NICKEL
БЛЕСТЯЩИЙ НИКЕЛЬ



(N)
NIKIEL
ANCIENT NICKEL
АНТИЧНЫЙ НИКЕЛЬ



(P)
PATYNA
PATINA
ПАТИНА

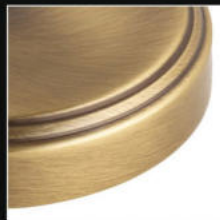

(Z)
ZŁOTO
GOLD
ЗОЛОТО



(ZM)
ZŁOTO MATOWE
MATT GOLD
МАТОВОЕ ЗОЛОТО



Merano Abazur



MER-LS-1 (P/A)

↑ 1700 mm ↔ 450 mm
💡 1 x max 40W E14



MER-K-1 (P/A)

↑ 390 mm ↔ 170 mm ↳ 190 mm
💡 1 x max 40W E14



MER-ZW-8 (P/A)

↑ 700 mm ↔ 770 mm
💡 8 x max 40W E14

500 mm

Merano Abażur

MER-PL-6 (P/A)

↓ 430 mm ↔ 750 mm
⊙ 6 x max 40W E14



MER-LG-1 (N/A) 300

↓ 650 mm ↔ 300 mm
⊙ 1 x max 60W E27



MER-ZW-6 (N/A)

↓ 700 mm ↔ 710 mm
⊙ 6 x max 40W E14





Merano Klosz

(BN)
BŁYSZCZĄCY NIKIEL
SHINY NICKEL
БЛЕСТЯЩИЙ НИКЕЛЬ



(N)
NIKIEL
ANCIENT NICKEL
АНТИЧНЫЙ НИКЕЛЬ



(P)
PATYNA
PATINA
ПАТИНА



(Z)
ZŁOTO
GOLD
ЗОЛОТО



(ZM)
ZŁOTO MATOWE
MATT GOLD
МАТОВОЕ ЗОЛОТО



Merano Klosz

MER-ZW-8 (P)

↓ 700 mm ↔ 720 mm

⊙ 8 x max 40W E14



MER-K-1 (N)

↓ 330 mm ↔ 100 mm | → 140 mm

⊙ 1 x max 40W E14



MER-ZW-6 (N)

↓ 700 mm ↔ 690 mm

⊙ 6 x max 40W E14



Merano Klosz



MER-K-1 (P) T

↑ 330 mm ↔ 150 mm |→ 190 mm

💡 1 x max 40W E14



MER-ZW-6 (ZM) T

↑ 700 mm ↔ 760 mm

💡 6 x max 40W E14

450 mm



Messina

(N)
NIKIEL
ANCIENT NICKEL
АНТИЧНЫЙ НИКЕЛЬ

(P)
PATYNA
PATINA
ПАТИНА

(Z)
ZŁOTO
GOLD
ЗОЛОТО



Messina

MES-LG-1 (P) GR

↑ 600 mm ↔ 300 mm

💡 1 x max 60W E27



MES-LG-1 (P)

↑ 600 mm ↔ 300 mm

💡 1 x max 60W E27



Monza

(N)
NIKIEL
ANCIENT NICKEL
АНТИЧНЫЙ НИКЕЛЬ

(P)
PATYNA
PATINA
ПАТИНА

(ZM)
ZŁOTO MATOWE
MATT GOLD
МАТОВОЕ ЗОЛОТО



Monza

MON-ZW-6 (N/A)

↑ 700 mm ↔ 850 mm

⊙ 6 x max 40W E14



MON-K-1 (P/A)

↑ 280 mm ↔ 180 mm |→ 220 mm

⊙ 1 x max 40W E14



MON-LG-1 (P/A)

↑ 480 mm ↔ 390/210 mm

⊙ 1 x max 60W E27

Monza

MON-ZW-8 (P/A)

↑ 700 mm ↔ 850 mm

⊙ 8 x max 40W E14



MON-ZWL-4 (P/A)

↑ 700 mm ↔ 1010/210 mm

⊙ 4 x max 40W E14



Monza

MON-LS-3 (P/A)

↑ 1760 mm ↔ 550 mm

⊙ 3 x max 40W E14



440 mm

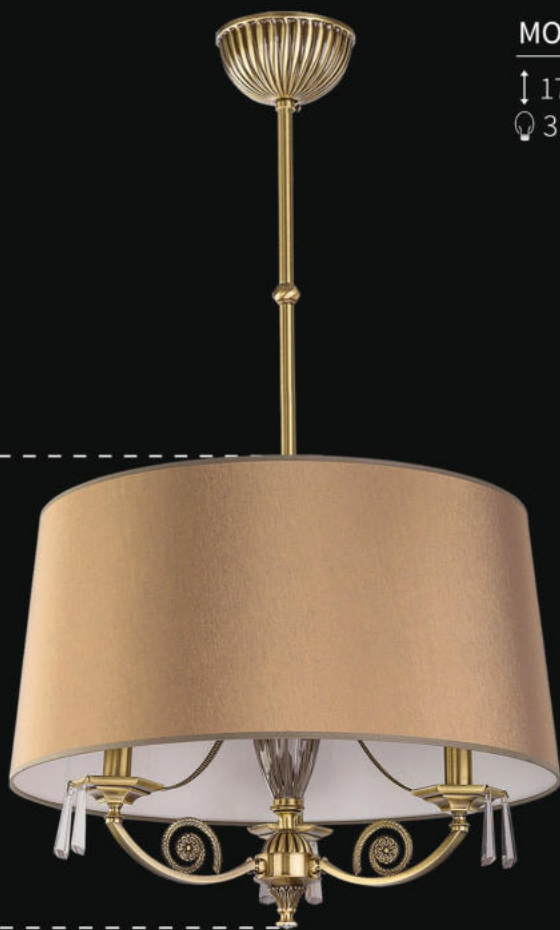

MON-ZWD-3 (P/A)

↑ 700 mm ↔ 600 mm

⊙ 3 x max 40W E14



660 mm

MON-ZWD-1(P/A)

↑ 950 mm ↔ 300 mm

⊙ 1 x max 60W E27



Monza



MON-ZW-3 (P/A)

↑ 700 mm ↔ 550 mm
💡 3 x max 40W E14

MON-K-2(P/A)

↑ 270 mm ↔ 470 mm |→ 255 mm
💡 2 x max 40W E14





N Abazur

(P)
PATYNA
PATINA
ПАТИНА

(Z)
ZŁOTO
GOLD
ЗОЛОТО

(ZM)
ZŁOTO MATOWE
MATT GOLD
МАТОВОЕ ЗОЛОТО



N Abażur

N-ZW-5 (P/A)

↓ 700 mm ↔ 580 mm

💡 5 x max 40W E14



N-K-1 (P/A)

↓ 250 mm ↔ 180 mm ↳ 290 mm

💡 1 x max 40W E14



N-K-2 (P/A)

↓ 250 mm ↔ 420 mm ↳ 260 mm

💡 2 x max 40W E14

N Abażur

N-ZW-3 (P/A)

↑ 700 mm ↔ 580 mm
💡 3 x max 40W E14



N-LG-1 (P/A)

↑ 360 mm ↔ 180 mm
💡 1 x max 40W E14



N-ZW-2 (P/A)

↑ 700 mm ↔ 580/180 mm
💡 2 x max 40W E14





N Klosz

(P)
PATYNA
PATINA
ПАТИНА

(Z)
ZŁOTO
GOLD
ЗОЛОТО

(ZM)
ZŁOTO MATOWE
MATT GOLD
МАТОВОЕ ЗОЛОТО



N Klosz

N-ZW-2 (P)

↓ 700 mm ↔ 600/200 mm
💡 2 x max 60W E27



N-ZW-3 (P)

↓ 700 mm ↔ 600 mm
💡 3 x max 60W E27



N Klosz

N-PL-2 (P)

↑ 200 mm ↔ 340 mm

⊙ 2 x max 60W E27



N-LG-1 (P)

↑ 370 mm ↔ 280 mm

⊙ 1 x max 60W E27



N-LS-3 (Z)

↑ 1600 mm ↔ 520 mm

⊙ 3 x max 60W E27

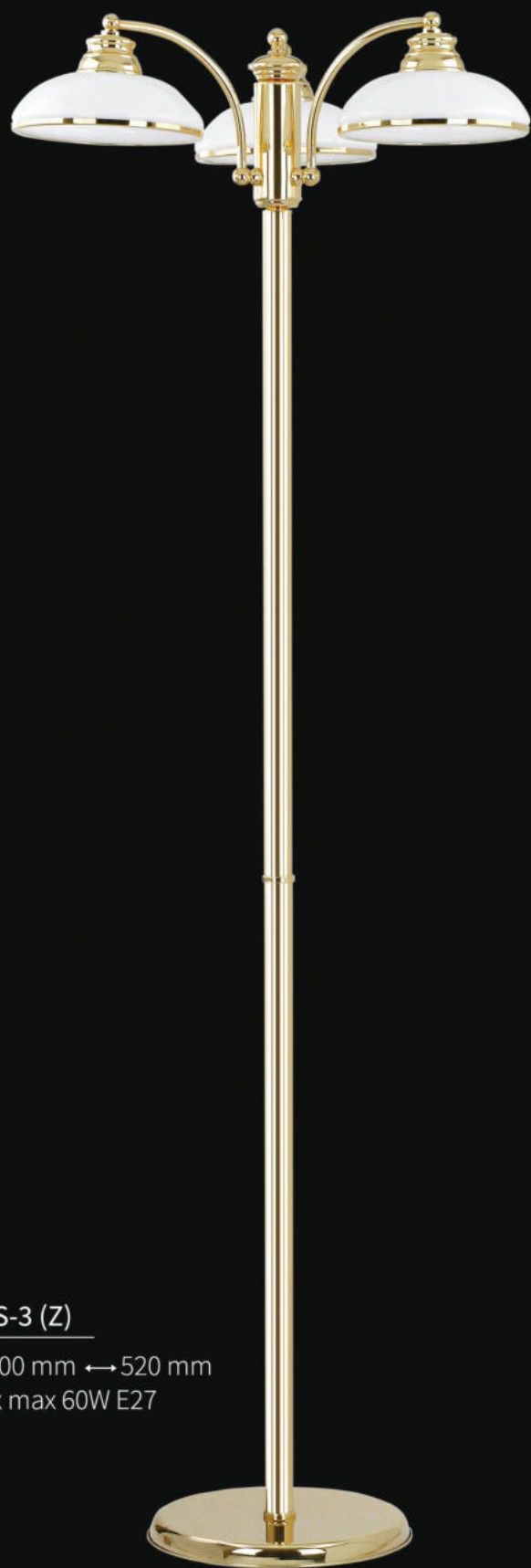

N Klosz



N-ZW-5 (P)

↑ 700 mm ↔ 600 mm

💡 5 x max 60W E27

N-K-1 (P)

↑ 250 mm ↔ 200 mm |→ 300 mm

💡 1 x max 60W E27



N-K-2 (P)

↑ 250 mm ↔ 410 mm |→ 290 mm

💡 2 x max 60W E27



Napoli

(BN)
BŁYSZCZĄCY NIKIEL
SHINY NICKEL
БЛЕСТЯЩИЙ НИКЕЛЬ



(N)
NIKIEL
ANCIENT NICKEL
АНТИЧНЫЙ НИКЕЛЬ



(P)
PATYNA
PATINA
ПАТИНА



(Z)
ZŁOTO
GOLD
ЗОЛОТО



(ZM)
ZŁOTO MATOWE
MATT GOLD
МАТОВОЕ ЗОЛОТО



Napoli

NAP-ZW-6 (N/A)

↓ 700 mm ↔ 730 mm

💡 6 x max 40W E14



500 mm



NAP-LG-1 (N/A)

↓ 660 mm ↔ 300 mm

💡 1 x max 60W E27

ZW - ŻYRANDOL / CHANDELIER / ЛЮСТРА

LG - LAMPA GABINETOWA / DESK LAMP / КАБИНЕТНАЯ ЛАМПА

A - ABAŻURY / LAMP SHADES / АБАЖУРЫ

Napoli

NAP-ZW-8 (Z/A)

↑ 700 mm ↔ 770 mm

⊙ 8 x max 40W E14



NAP-PL-6 (P/A)

↑ 350 mm ↔ 780 mm

⊙ 6 x max 40W E14



Napoli

NAP-ZWD-1 (P/A)

↑ 1000 mm ↔ 450 mm
💡 1 x max 60W E27

NAP-LS-1 (N/A)

↑ 1700 mm ↔ 450 mm
💡 1 x max 60W E27

NAP-K-1 (P/A)

↑ 380 mm ↔ 150 mm | → 200 mm
💡 1 x max 40W E14

750 mm

ZWD - ŻYRANDOL DUŻY / CHANDELIER (LARGE DIFFUSER)
/ ЛЮСТРА (БОЛЬШОЙ ПЛАФОН)
K - KINKIET / WALL LAMP / БРА

A - ABAŻURY / LAMP SHADES / АБАЖУРЫ
LS - LAMPA PODŁOGOWA / FLOOR LAMP / ТОРШЕР



Nico

(N)
NIKIEL
ANCIENT NICKEL
АНТИЧНЫЙ НИКЕЛЬ

(P)
PATYNA
PATINA
ПАТИНА

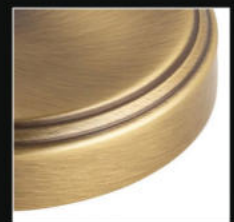

Nico



Nico



NIC-ZW-10 (P/A)

↑ 700 mm ↔ 860 mm

💡 10 x max 40W E14

560 mm



NIC-ZW-8 (P/A)

↑ 700 mm ↔ 700 mm

💡 8 x max 40W E14

460 mm

Nico



NIC-LS-3 (P/A)

↓ 1840 mm ↔ 530 mm
💡 3 x max 40W E14



NIC-K-2 (P/A)

↓ 290 mm ↔ 390 mm ↳ 260 mm
💡 2 x max 40W E14



NIC-K-1 (P/A)

↓ 290 mm ↔ 180 mm ↳ 290 mm
💡 1 x max 40W E14



NIC-LN-1 (P/A)

↓ 510 mm ↔ 300 mm
💡 1 x max 60W E27



OBD

(P)
PATYNA
PATINA
ПАТИНА



(Z)
ZŁOTO
GOLD
ЗОЛОТО



(ZM)
ZŁOTO MATOWE
MATT GOLD
МАТОВОЕ ЗОЛОТО



OBD

OBD-ZW-3 (P)

↑ 700 mm ↔ 600 mm
💡 3 x max 60W E27



OBD-K-1 (P)

↑ 250 mm ↔ 200 mm |→ 300 mm
💡 1 x max 60W E27



OBD-ZW-1 (P)

↑ 760 mm ↔ 300 mm
💡 1 x max 60W E27



OBD

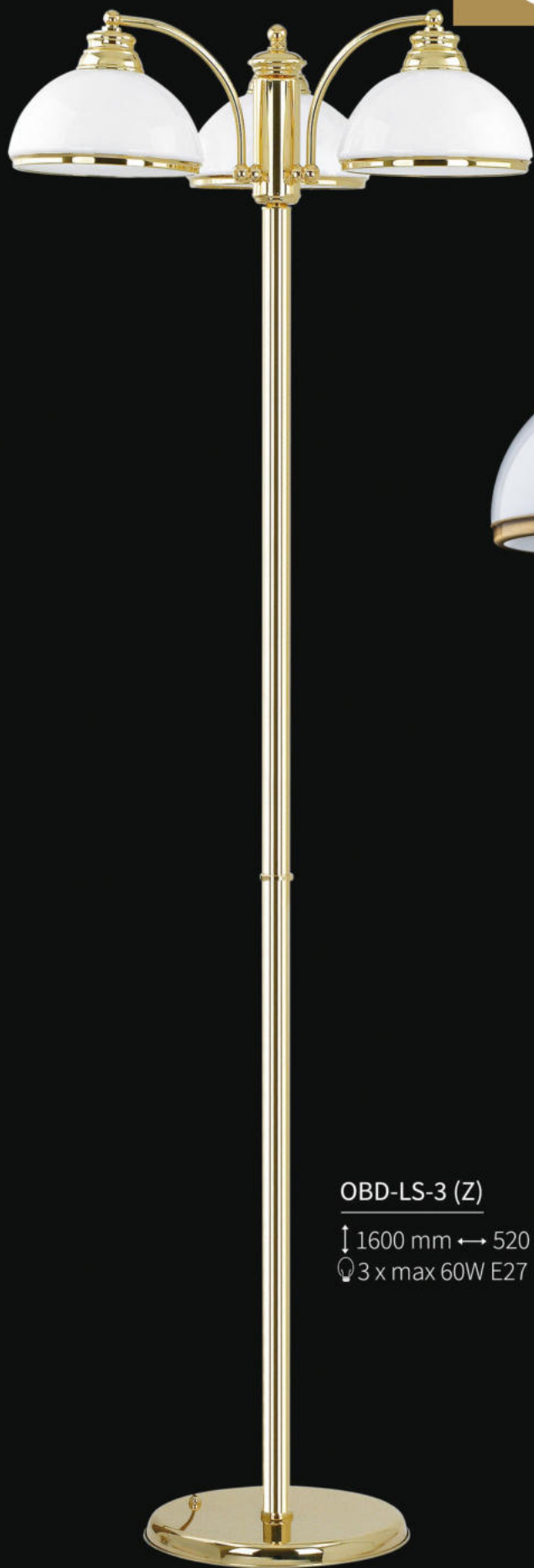

OBD-K-2 (P)

↓ 250 mm ↔ 410 mm ↳ 380 mm
💡 2 x max 60W E27



OBD-LG-1 (P)

↓ 370 mm ↔ 280 mm
💡 1 x max 60W E27



OBD-LS-3 (Z)

↓ 1600 mm ↔ 520 mm
💡 3 x max 60W E27

OBD-PL-2 (P)

↑ 200 mm ↔ 340 mm
 ⚡ 2 x max 60W E27



OBD-ZW-2 (P)

↑ 700 mm ↔ 600/200 mm
 ⚡ 2 x max 60W E27



OBD-ZW-5 (P)

↑ 700 mm ↔ 600 mm
 ⚡ 5 x max 60W E27





Olzano

(BN)
BŁYSZCZĄCY NIKIEL
SHINY NICKEL
БЛЕСТЯЩИЙ НИКЕЛЬ



(N)
NIKIEL
ANCIENT NICKEL
АНТИЧНЫЙ НИКЕЛЬ



(P)
PATYNA
PATINA
ПАТИНА



(Z)
ZŁOTO
GOLD
ЗОЛОТО



(ZM)
ZŁOTO MATOWE
MATT GOLD
МАТОВОЕ ЗОЛОТО



Olzano

OLZ-KD-1 (P)

↓ 850 mm ↔ 120 mm ↳ 160 mm
💡 1 x max 40W E14



OLZ-ZW-8 (P)

↓ 700 mm ↔ 820 mm
💡 8 x max 40W E14



460 mm

Olzano



OLZ-K-1 (P)

↓ 280 mm ↔ 120 mm ↳ 200 mm

⊙ 1 x max 40W E14



OLZ-ZW-6 (BN)

↓ 700 mm ↔ 820 mm

⊙ 6 x max 40W E14



460 mm



Orezzo

(BN)
BŁYSZCZĄCY NIKIEL
SHINY NICKEL
БЛЕСТЯЩИЙ НИКЕЛЬ



(N)
NIKIEL
ANCIENT NICKEL
АНТИЧНЫЙ НИКЕЛЬ



(P)
PATYNA
PATINA
ПАТИНА



(Z)
ZŁOTO
GOLD
ЗОЛОТО



(ZM)
ZŁOTO MATOWE
MATT GOLD
МАТОВОЕ ЗОЛОТО



Orezzo

ORE-K-2 (ZM)

↓ 750 mm ↔ 50 mm ↳ 100 mm
💡 2 x max 40W E14



ORE-ZW-1 (ZM)

↓ 700 mm ↔ 100 mm
💡 1 x max 40W E14



ORE-ZW-2 (Z)

↓ 700 mm ↔ 880/50 mm
💡 2 x max 40W E14



ORE-ZW-2x2 (ZM)

↓ min. 350 mm ↔ 500 /1300 mm
💡 4 x max 40W E14



ORE-ZW-3x2 (P)

↓ min. 450 mm ↔ 750/1500 mm
💡 6 x max 40W E14

Orezzo

ORE-ZW-6 (P)

↓ 700 mm ↔ 860 mm

💡 6 x max 40W E14

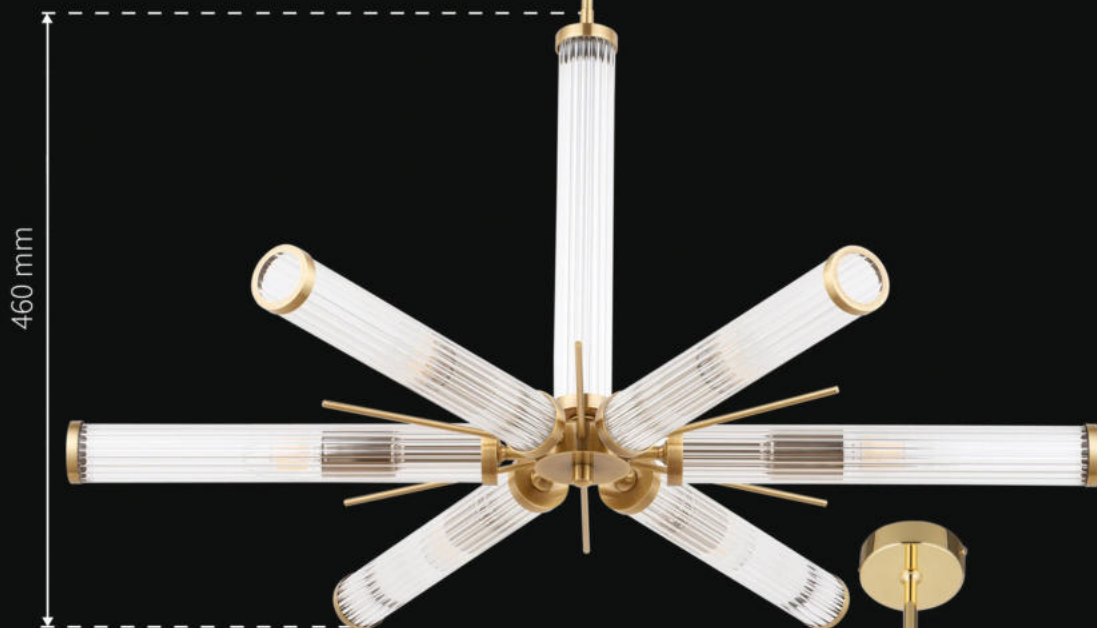

ORE-ZW-8 (Z)

↓ 700 mm ↔ 890 mm

💡 8 x max 40W E14





Prima

(N)
NIKIEL
ANCIENT NICKEL
АНТИЧНЫЙ НИКЕЛЬ

(P)
PATYNA
PATINA
ПАТИНА

(Z)
ZŁOTO
GOLD
ЗОЛОТО

(ZM)
ZŁOTO MATOWE
MATT GOLD
МАТОВОЕ ЗОЛОТО



Prima

PRI-K-1 (P)

↓ 300 mm ↔ 150 mm ↳ 290 mm

⊙ 1 x max 5W G9



PRI-ZW-6 (Z)

↓ 700 mm ↔ 810 mm

⊙ 6 x max 5W G9



Prima



PRI-LG-1 (P/A)

↑ 640 mm ↔ 300 mm
⊙ 1 x max 60W E27



PRI-ZW-8 (P)

↑ 700 mm ↔ 810 mm
⊙ 8 x max 5W G9



500 mm

Prima

PRI-ZW-1 (ZM)

↑ 700 mm ↔ 150 mm
⊙ 1 x max 5W G9

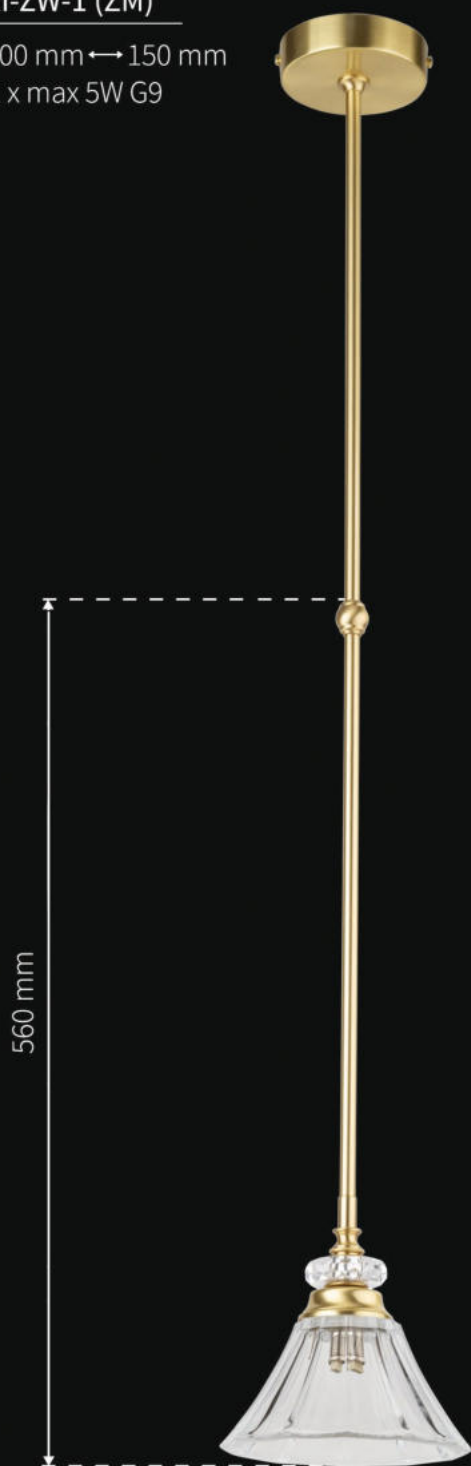

PRI-ZW-18 (ZM)

↑ 3000 mm ↔ 600 mm
⊙ 18 x max

3000 mm





Roma Abazur

(P)
РАТУНА
PATINA
ПАТИНА

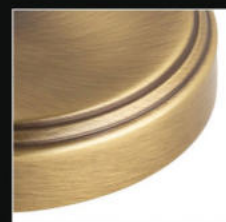

Roma Abazur



ROM-K-1 (P/A)

↑ 250 mm ↔ 180 mm ↳ 260 mm

💡 1 x max 40W E14



ROM-ZW-8+1 (P/A)

↑ 900 mm ↔ 950 mm

💡 8 x max 40W E14

💡 3 x max 60W E27

670 mm



Roma Abazur



ROM-K-2 (P/A)

↓ 250 mm ↔ 350 mm ↳ 260 mm
💡 2 x max 40W E14



ROM-LG-1 (P/A)

↓ 430 mm ↔ 300 mm
💡 1 x max 60W E27



600 mm

ROM-ZW-6+1 (P/A)

↓ 700 mm ↔ 850 mm
💡 6 x max 40W E14
💡 2 x max 60W E27



Roma Klosz

(P)
РАТУНА
PATINA
ПАТИНА



Roma Klosz



ROM-K-2 (P)

↓ 240 mm ↔ 410 mm | → 270 mm
💡 2 x max 60W E27



ROM-ZW-6+1 (P)

↓ 800 mm ↔ 820 mm
💡 8 x max 60W E27

600 mm

Roma Klosz



ROM-PLM-3 (P)

↓ 220 mm ↔ 300 mm
💡 3 x max 60W E27

ROM-LG-1 (P)

↓ 560 mm ↔ 300 mm
💡 1 x max 60W E27



ROM-ZW-8+1 (P)

↓ 800 mm ↔ 950 mm
💡 11 x max 60W E27

Roma Klosz

ROM-K-1 (P)

↓ 250 mm ↔ 200 mm ↳ 280 mm
💡 1 x max 60W E27



ROM-LS-3 (P)

↓ 1660 mm ↔ 500 mm
💡 3 x max 60W E27



ROM-ZW-3+1 (P)

↓ 700 mm ↔ 620 mm
💡 5 x max 60W E27

540 mm





Rossano

(BN)
BŁYSZCZĄCY NIKIEL
SHINY NICKEL
БЛЕСТЯЩИЙ НИКЕЛЬ



(N)
NIKIEL
ANCIENT NICKEL
АНТИЧНЫЙ НИКЕЛЬ



(P)
PATYNA
PATINA
ПАТИНА



(Z)
ZŁOTO
GOLD
ЗОЛОТО



(ZM)
ZŁOTO MATOWE
MATT GOLD
МАТОВОЕ ЗОЛОТО



Rossano

ROS-PL-6 (P/A)

↑ 370 mm ↔ 780 mm

⦿ 6 x max 40W E14



ROS-ZW-8+4 (P/A)

↑ 1000 mm ↔ 1000 mm

⦿ 12 x max 40W E14



Rossano



ROS-LS-1 (Z/A)

↓ 1840 mm ↔ 450 mm

💡 1 x max 60W E27



ROS-ZW-6 (BN/A)

↓ 700 mm ↔ 750 mm

💡 6 x max 40W E14

400 mm

Rossano

ROS-ZW-8 (P/A)

↓ 700 mm ↔ 750 mm

💡 8 x max 40W E14



400 mm

ROS-K-1 (P/A)

↓ 370 mm ↔ 150 mm | → 230 mm

💡 1 x max 40W E14



ROS-LG-1 (P/A)

↓ 560 mm ↔ 300 mm

💡 1 x max 60W E27





Saletto

(BN)
 BŁYSZCZĄCY NIKIEL
 SHINY NICKEL
 БЛЕСТЯЩИЙ НИКЕЛЬ



(N)
 NIKIEL
 ANCIENT NICKEL
 АНТИЧНЫЙ НИКЕЛЬ



(P)
 PATYNA
 PATINA
 ПАТИНА



(Z)
 ZŁOTO
 GOLD
 ЗОЛОТО



(ZM)
 ZŁOTO MATOWE
 MATT GOLD
 МАТОВОЕ ЗОЛОТО



Saletto

SAL-PL-16 (ZM)

↓ 700 mm ↔ 810 mm

💡 16 x max 40W E14



SAL-K-1 (P)

↓ 230 mm ↔ 80 mm | → 100 mm

💡 1 x max 40W E14



SAL-LG-2 (Z)

↓ 565 mm ↔ 420/130 mm

💡 2 x max 40W E14



Saletto

SAL-K-2 (Z)

↓ 390 mm ↔ 80 mm | → 110 mm
💡 2 x max 40W E14

SAL-ZW-8 (Z)

↓ 900 mm ↔ 760 mm
💡 16 x max 40W E14

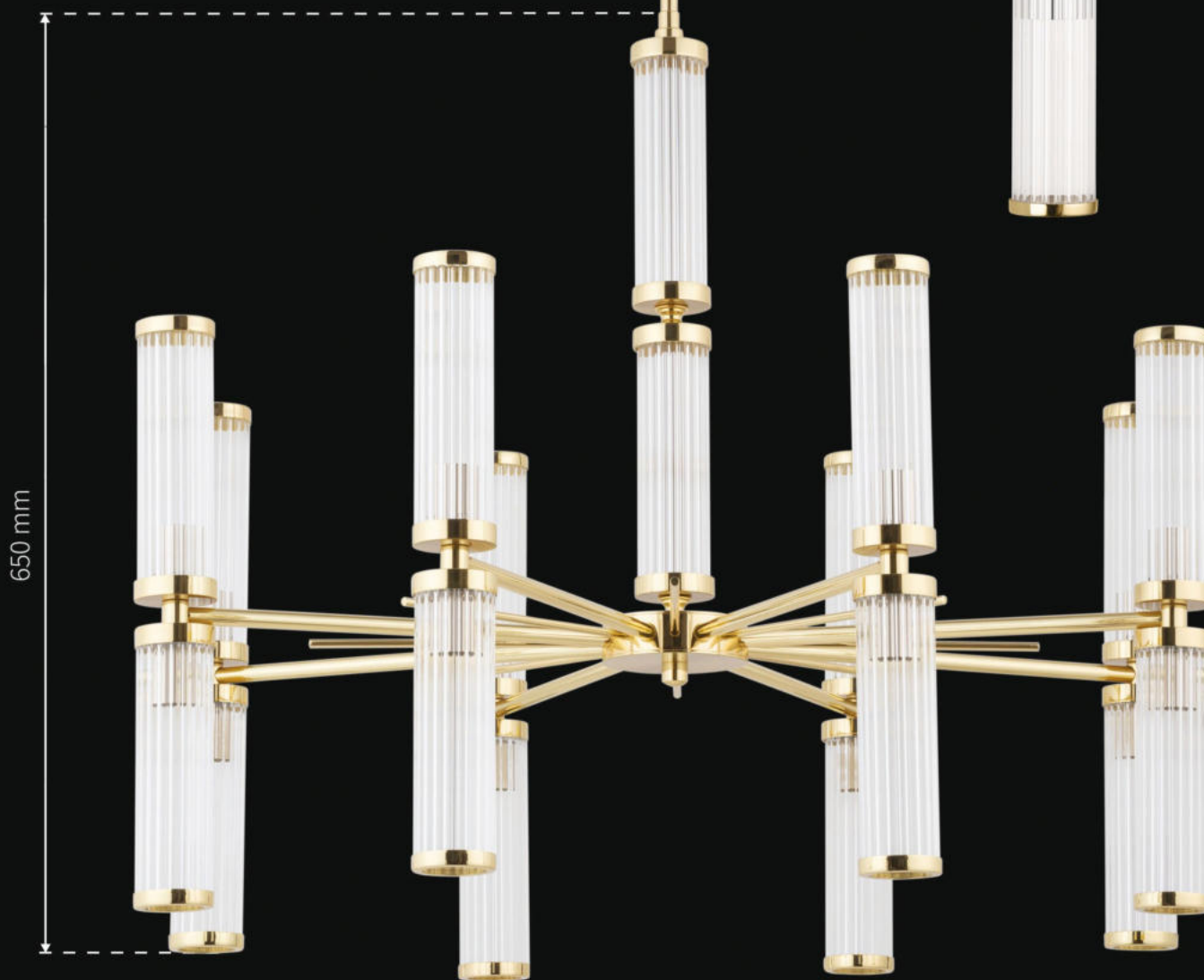

Saletto

SAL-ZW-6 (P)

↑ 900 mm ↔ 740 mm

💡 12 x max 40W E14



SAL-OCZ-1 (P)

↑ 130 mm ↔ 100 mm

💡 1 x G9 max 5W



Saletto

SAL-ZW-32 (P) 80

↑ 1000 mm ↔ 800 mm

💡 32 x max 40W E14

740 mm



Saletto

SAL-ZW-16 (ZM)

↓ 700 mm ↔ 810 mm

⊙ 16 x max 40W E14



ZW - ŻYRANDOL / CHANDELIER / ЛЮСТРА

Saletto

SAL-ZW-32 (ZM) 115

↑ 1000 mm ↔ 1150 mm

⊙ 32 x max 40W E14





San Marino Abazur

(BN)
BŁYSZCZĄCY NIKIEL
SHINY NICKEL
БЛЕСТЯЩИЙ НИКЕЛЬ

(N)
NIKIEL
ANCIENT NICKEL
АНТИЧНЫЙ НИКЕЛЬ

(P)
PATYNA
PATINA
ПАТИНА

(Z)
ZŁOTO
GOLD
ЗОЛОТО

(ZM)
ZŁOTO MATOWE
MATT GOLD
МАТОВОЕ ЗОЛОТО



San Marino Abazur

SAN-ZW-5 (Z/A) CR

↓ 700 mm ↔ 660 mm

💡 5 x max 40W E14



SAN-LG-1 (P/A) CR

↓ 520 mm ↔ 300 mm

💡 1 x max 60W E27

SAN-ZW-3 (P/A) CR

↓ 700 mm ↔ 660 mm

💡 3 x max 40W E14



San Marino Abażur



SAN-K-2 (P/A) CR

↑ 310 mm ↔ 370 mm ↳ 250 mm
💡 2 x max 40W E14



SAN-K-1 (P/A) CR

↑ 310 mm ↔ 180 mm ↳ 290
💡 1 x max 40W E14

SAN-ZW-10 (P/A) CR

↑ 800 mm ↔ 860 mm
💡 10 x max 40W E14



500 mm

ZW - ŻYRANDOL / CHANDELIER / ЛЮСТРА

K-2 - PODWÓJNY KINKIET / DOUBLE WALL LAMP / ДВОЙНОЕ БРА

CR - WERSJA Z KRYSZTAŁAMI / VERSION WITH CRYSTALS / ВЕРСИЯ С КРИСТАЛЛАМИ

K - KINKIET / WALL LAMP / БРА

A - ABAŻURY / LAMP SHADES / АБАЖУРЫ

San Marino Abazur

SAN-ZW-8 (P/A) CR

↓ 700 mm ↔ 700 mm

💡 8 x max 40W E14



SAN-ZW-6 (P/A) CR

↓ 700 mm ↔ 660 mm

💡 6 x max 40W E14



San Marino Abażur

SAN-LS-1 (P/A) CR

↑ 1780 mm ↔ 450 mm
💡 1 x max 60W E27



SAN-ZW-2 (P/A) CR

↑ 700 mm ↔ 640/180 mm
💡 2 x max 40W E14



San Marino Klosz

(BN)
BŁYSZCZĄCY NIKIEL
SHINY NICKEL
БЛЕСТЯЩИЙ НИКЕЛЬ



(N)
NIKIEL
ANCIENT NICKEL
АНТИЧНЫЙ НИКЕЛЬ



(P)
PATYNA
PATINA
ПАТИНА



(Z)
ZŁOTO
GOLD
ЗОЛОТО



(ZM)
ZŁOTO MATOWE
MATT GOLD
МАТОВОЕ ЗОЛОТО



San Marino Klosz

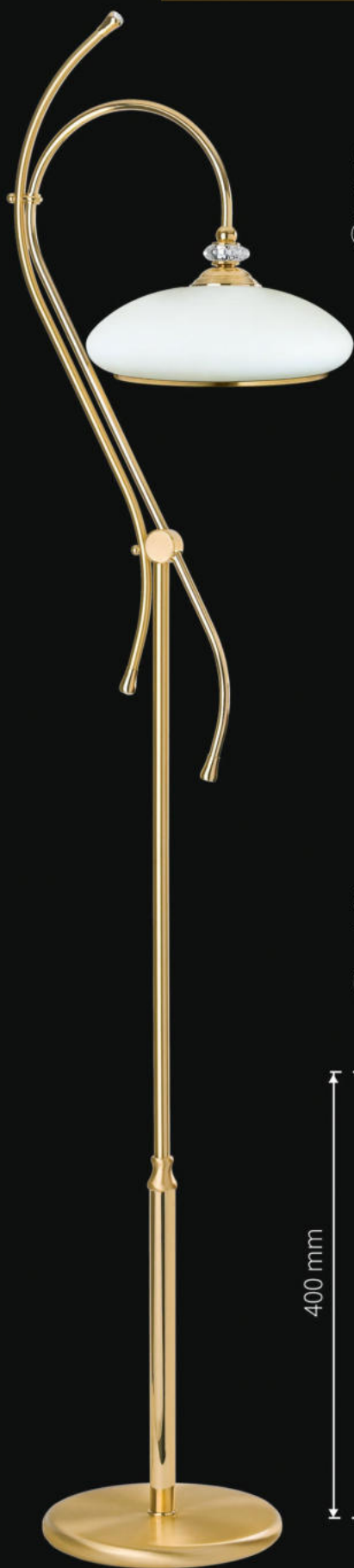

SAN-LS-1 (Z) CR

↑ 1770 mm ↔ 440 mm
💡 1 x max 60W E27



SAN-K-1 (P) CR

↑ 300 mm ↔ 250 mm |→ 340 mm
💡 1 x max 60W E27

SAN-ZW-3 (P) CR

↑ 700 mm ↔ 730 mm
💡 3 x max 60W E27



San Marino Klosz



SAN-LN-1 (P) CR

↑ 520 mm ↔ 260 mm
💡 1 x max 60W E27

400 mm



SAN-ZW-2 (P) CR

↑ 700 mm ↔ 710/480 mm
💡 2 x max 60W E27



SAN-ZW-5 (Z) CR

↑ 700 mm ↔ 730 mm
💡 5 x max 60W E27

San Marino Klosz

SAN-ZW-8 (P) CR

↑ 700 mm ↔ 960 mm

💡 8 x max 60W E27



SAN-LG-1 (P) CR

↑ 510 mm ↔ 290 mm

💡 1 x max 60W E27



Sienna

(N)
NIKIEL
ANCIENT NICKEL
АНТИЧНЫЙ НИКЕЛЬ



(P)
PATYNA
PATINA
ПАТИНА



(Z)
ZŁOTO
GOLD
ЗОЛОТО



(ZM)
ZŁOTO MATOWE
MATT GOLD
МАТОВОЕ ЗОЛОТО



Sienna

SIE-ZWD-1 (P) 400

↑ 1400 mm ↔ 400 mm
⊙ 11 x max 40W E14



SIE-ZWD-1 (N) 300

↑ 1300 mm ↔ 300 mm
⊙ 11 x max 40W E14



Sienna

SIE-ZWD-1 (P) 600

↓ 1800 mm ↔ 600 mm

💡 14 x max 60W E27



1460 mm



SIE-OCZ-3 (Z)

↓ 350 mm ↔ 190 mm

💡 3 x max 40W E14

Sienna

SIE-ZW-6 (P)

↓ 1200 mm ↔ 750 mm

💡 6 x max 60W E27

💡 11 x max 40W E14

980 mm



Sienna

SIE-ZW-10 (P)

↓ 1200 mm ← 970 mm

💡 10 x max 60W E27

💡 11 x max 40W E14

980 mm

Sienna

SIE-ZW-12 (P)

↑ 1400 mm ↔ 1200 mm

💡 12 x max 60W E27

💡 12 x max 40W E14

1100 mm



Sienna



SIE-K-1 (P)

↑ 370 mm ↔ 120 mm | → 280 mm
⊙ 1 x max 60W E27



SIE-K-2 (P)

↑ 370 mm ↔ 430 mm | → 240 mm
⊙ 2 x max 60W E27



SIE-K-3 (P)

↑ 370 mm ↔ 430 mm | → 370 mm
⊙ 3 x max 60W E27

Sienna

SIE-ZW-20 (ZM)

↑ 1800 mm ↔ 1900 mm

⊙ 34 x max 60W E27

1460 mm





Sorrento

(P)
РАТУНА
PATINA
ПАТИНА



Sorrento

SOR-PL-3 (P)

↓ 420 mm ↔ 410 mm
💡 3 x max 60W E27



SOR-ZWR-1 (P)

↓ 700 mm ↔ 380 mm
💡 1 x max 60W E27

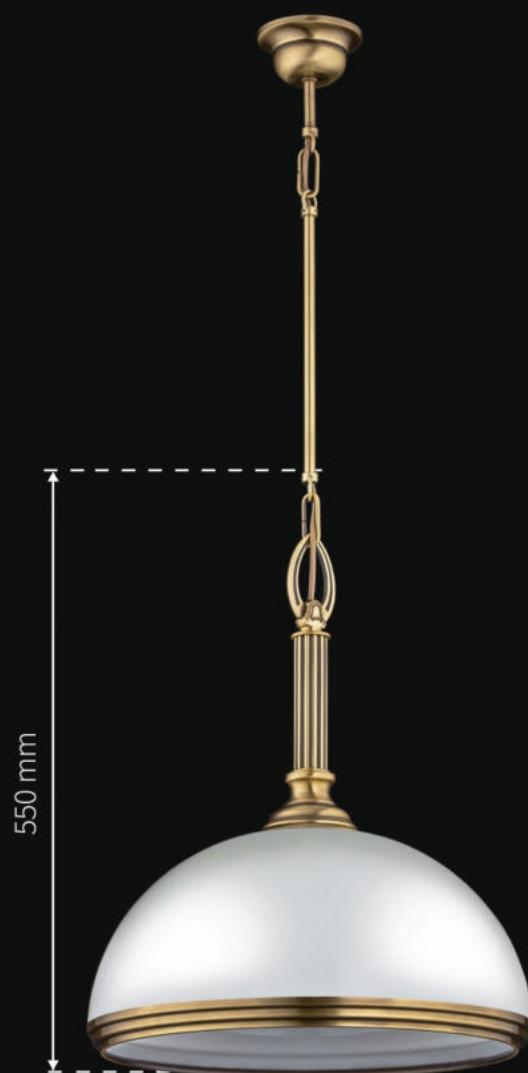

SOR-ZWD-1 (P)

↓ 660 mm ↔ 410 mm
💡 3 x max 60W E27



Sorrento



SOR-K-1 (P)

↓ 300 mm ↔ 250 mm ↗ 350 mm
💡 1 x max 60W E27



SOR-LS-1 (P)

↓ 1760 mm ↔ 400 mm
💡 1 x max 60W E27



SOR-LGR-1 (P) GR

↓ 540 mm ↔ 300 mm
💡 1 x max 60W E27



SOR-LGR-1 (P)

↓ 540 mm ↔ 300 mm
💡 1 x max 60W E27

Sorrento

SOR-ZW-5 (P)

↓ 700 mm ↔ 700 mm

💡 5 x max 60W E27



SOR-LG-1 (P) GR

↓ 540 mm ↔ 290 mm

💡 1 x max 60W E27



SOR-LG-1 (P)

↓ 540 mm ↔ 290 mm

💡 1 x max 60W E27

Sorrento

SOR-ZW-3 (P)

↓ 700 mm ↔ 700 mm
💡 3 x max 60W E27

SOR-ZW-1 (P)

↓ 700 mm ↔ 290 mm
💡 1 x max 60W E27

360 mm



SOR-PLM-3 (P)

↓ 200 mm ↔ 410 mm
💡 3 x max 60W E27

420 mm

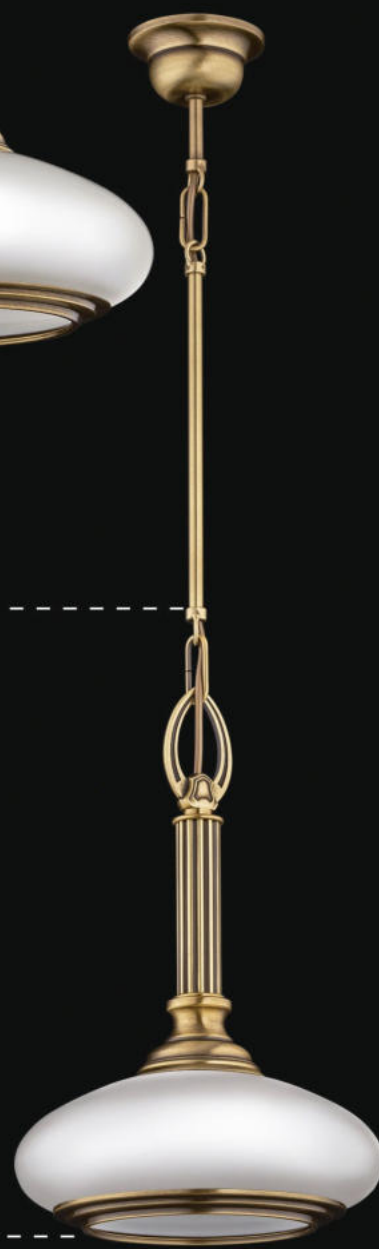



Tadea

(BN)
 BŁYSZCZĄCY NIKIEL
 SHINY NICKEL
 БЛЕСТЯЩИЙ НИКЕЛЬ



(N)
 NIKIEL
 ANCIENT NICKEL
 АНТИЧНЫЙ НИКЕЛЬ



(P)
 PATYNA
 PATINA
 ПАТИНА



(Z)
 ZŁOTO
 GOLD
 ЗОЛОТО



(ZM)
 ZŁOTO MATOWE
 MATT GOLD
 МАТОВОЕ ЗОЛОТО



Tadea

TAD-ZW-6 (BN/A)

↑ 700 mm ↔ 800 mm - 1400 mm
⊙ 6 x max 40W E14



TAD-K-1 (P/A)

↑ 230-350 mm ↔ 330-650 mm
⊙ 1 x max 40W E14



TAD-LG-1 (P/A)

↑ 510-810 mm ↔ 370-650 mm
⊙ 1 x max 40W E14



Tadea



TAD-LG-1 (P/A)

↑ 510-810 mm ↔ 370-650 mm
💡 1 x max 60W E27



TAD-K-1 (BN/A)

↑ 230-350 mm ↔ 330-650 mm
💡 1 x max 40W E14



Tamara

(BN)
BŁYSZCZĄCY NIKIEL
SHINY NICKEL
БЛЕСТЯЩИЙ НИКЕЛЬ



(N)
NIKIEL
ANCIENT NICKEL
АНТИЧНЫЙ НИКЕЛЬ



(P)
PATYNA
PATINA
ПАТИНА



(Z)
ZŁOTO
GOLD
ЗОЛОТО



(ZM)
ZŁOTO MATOWE
MATT GOLD
МАТОВОЕ ЗОЛОТО



Tamara

TAM-ZW-8 (Z/A)

↑ 700 mm ↔ 860 mm

💡 8 x max 40W E14



TAM-ZW-6 (Z/A)

↑ 700 mm ↔ 820 mm

💡 6 x max 40W E14



Tamara

TAM-ZWD-1 (N/A)

↑ 900 mm ↔ 450 mm
💡 1 x max 60W E27

770 mm



TAM-K-1 (P/A)

↑ 425 mm ↔ 180 mm ↳ 200 mm
💡 1 x max 40W E14



Tamara

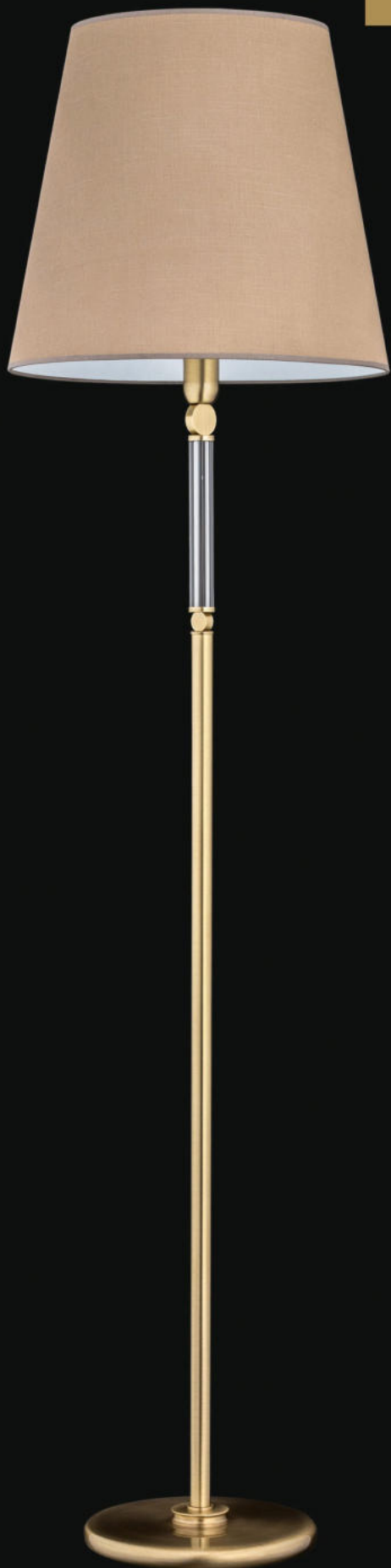

TAM-LS-1 (P/A)

↑ 1770 mm ↔ 450 mm

💡 1 x max 60W E27

TAM-LG-1 (P/A)

↑ 560 mm ↔ 320 mm

💡 1 x max 60W E27





Usini

(BN)
BŁYSZCZĄCY NIKIEL
SHINY NICKEL
БЛЕСТЯЩИЙ НИКЕЛЬ



(N)
NIKIEL
ANCIENT NICKEL
АНТИЧНЫЙ НИКЕЛЬ



(P)
PATYNA
PATINA
ПАТИНА



(Z)
ZŁOTO
GOLD
ЗОЛОТО



(ZM)
ZŁOTO MATOWE
MATT GOLD
МАТОВОЕ ЗОЛОТО



Usini

USI-ZW-6 (Z)

↑ 700 mm ↔ 770 mm
💡 6 x max 40W E14



USI-K-1 (N)

↑ 350 mm ↔ 120 mm | → 190 mm
💡 1 x max 40W E14



USI-ZW-8 (BN)

↑ 700 mm ↔ 800 mm
💡 8 x max 40W E14





Vera

(BN)
BŁYSZCZĄCY NIKIEL
SHINY NICKEL
БЛЕСТЯЩИЙ НИКЕЛЬ



(N)
NIKIEL
ANCIENT NICKEL
АНТИЧНЫЙ НИКЕЛЬ



(P)
PATYNA
PATINA
ПАТИНА



(Z)
ZŁOTO
GOLD
ЗОЛОТО



(ZM)
ZŁOTO MATOWE
MATT GOLD
МАТОВОЕ ЗОЛОТО



Vera

VER-LG-1 (Z/A)

↑ 800 mm ↔ 300 mm

💡 1 x max 60W E27



VER-LG-1 (P/A) SZ-I

↑ 700 mm ↔ 320 mm

💡 1 x max 60W E27



VER-LG-1 (ZM/A) SZ-II

↑ 700 mm ↔ 320 mm

💡 1 x max 60W E27





Vesto

(BN)
BŁYSZCZĄCY NIKIEL
SHINY NICKEL
БЛЕСТЯЩИЙ НИКЕЛЬ



(N)
NIKIEL
ANCIENT NICKEL
АНТИЧНЫЙ НИКЕЛЬ



(P)
PATYNA
PATINA
ПАТИНА



(Z)
ZŁOTO
GOLD
ЗОЛОТО



(ZM)
ZŁOTO MATOWE
MATT GOLD
МАТОВОЕ ЗОЛОТО



Vesto

VES-ZW-3 (P) P

↓ 700 mm ↔ 290 mm
💡 3 x max 5W G9

VES-ZW-1 (Z) K

↓ 700 mm ↔ 100 mm
💡 1 x max 5W G9

VES-ZW-1 (ZM) P

↓ 700 mm ↔ 100 mm
💡 1 x max 5W G9

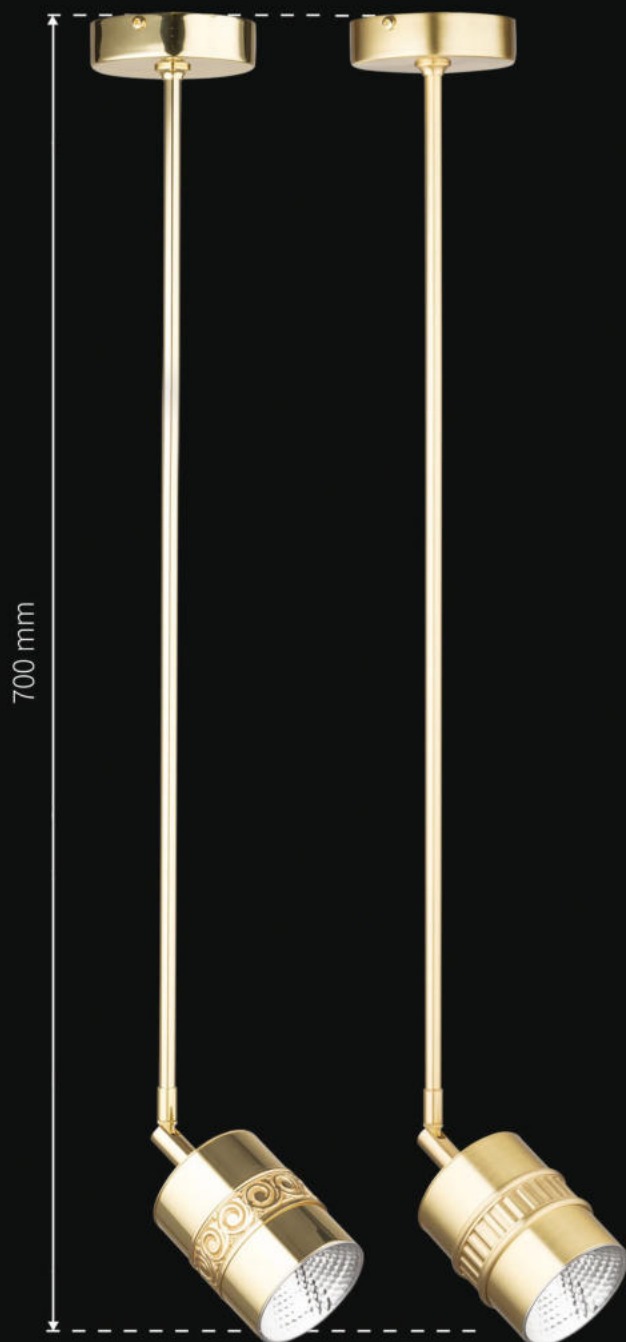

Vesto

VES-K-1 (Z) P

↑ 80 - 195 mm ↔ 80 mm | → 80 - 190 mm
💡 1 x max 5W G9



VES-LS-1 (P) P

↑ 1530 mm ↔ 320 mm
💡 1 x max 5W G9

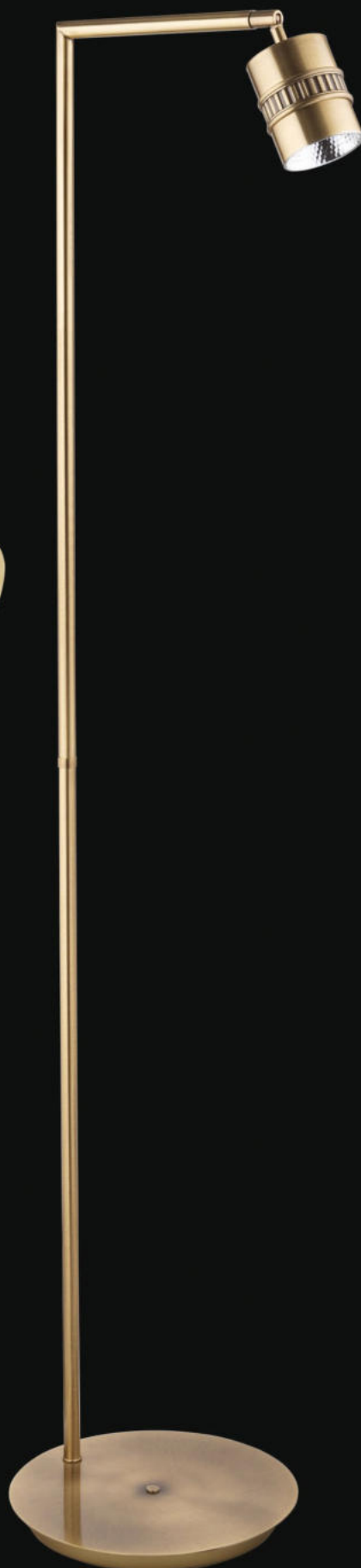

VES-LG-1 (P) P

↑ 530 mm ↔ 140 mm
💡 1 x max 5W G9

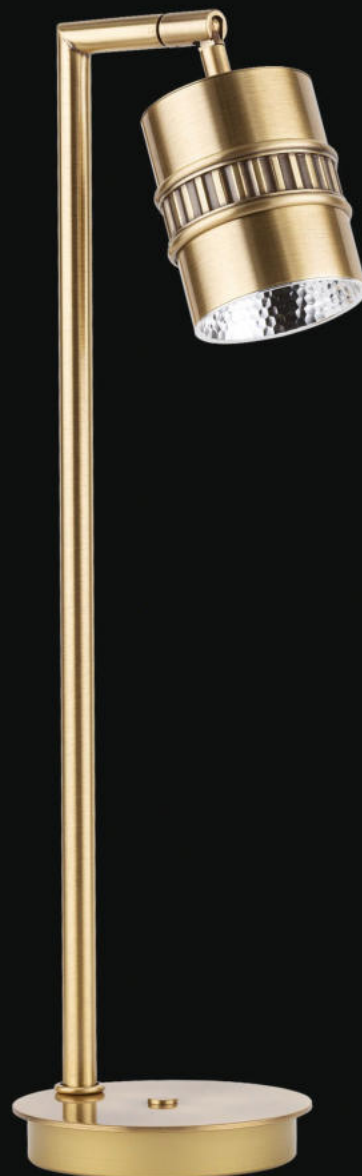



Zaffiro

(BN)
BŁYSZCZĄCY NIKIEL
SHINY NICKEL
БЛЕСТЯЩИЙ НИКЕЛЬ



(N)
NIKIEL
ANCIENT NICKEL
АНТИЧНЫЙ НИКЕЛЬ



(P)
PATYNA
PATINA
ПАТИНА



(Z)
ZŁOTO
GOLD
ЗОЛОТО



(ZM)
ZŁOTO MATOWE
MATT GOLD
МАТОВОЕ ЗОЛОТО



Zaffiro



530 mm

ZAF-ZW-6 (N/A)

↑ 700 mm ↔ 880 mm

⦿ 6 x max 40W E14



530 mm

ZAF-ZW-8 (P/A)

↑ 700 mm ↔ 880 mm

⦿ 8 x max 40W E14

Zaffiro



ZAF-ZW-8+4 (P/A)

↓ 1000 mm ↔ 1200 mm

⊙ 12 x max 40W E14



ZAF-ZW-2 (P/A)

↓ 700 mm ↔ 990 mm

⊙ 2 x max 60W E27

Zaffiro

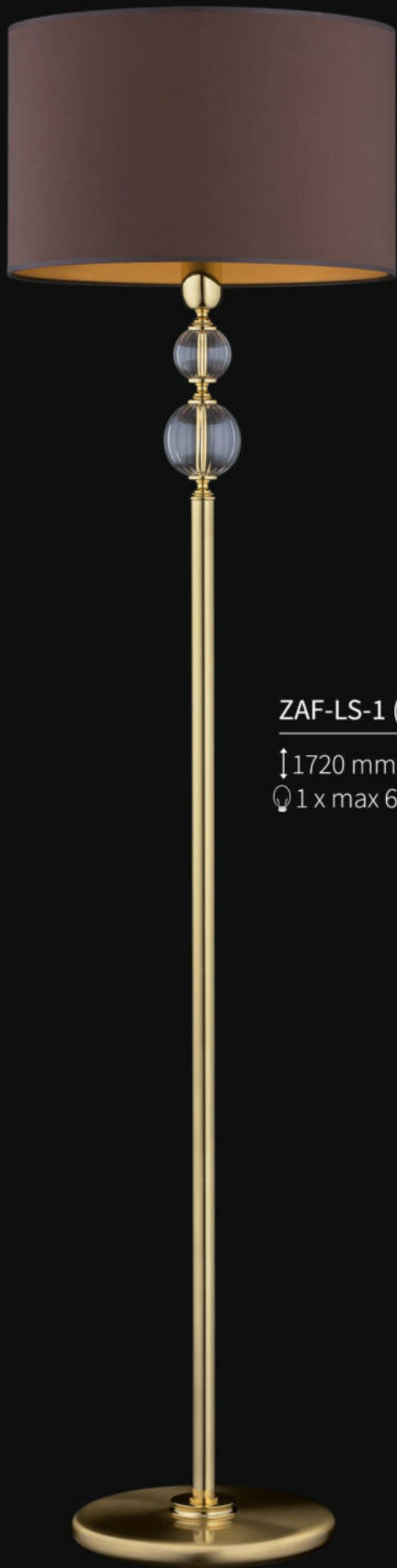

ZAF-LS-1 (P/A)

↑ 1720 mm ↔ 400 mm
💡 1 x max 60W E27



ZAF-K-1 (P/A)

↑ 270 mm ↔ 180 mm | → 250 mm
💡 1 x max 40W E14



ZAF-LG-1 (P/A)

↑ 470 mm ↔ 300 mm
💡 1 x max 60W E27



Zeri

(BN)
 BŁYSZCZĄCY NIKIEL
 SHINY NICKEL
 БЛЕСТЯЩИЙ НИКЕЛЬ



(N)
 NIKIEL
 ANCIENT NICKEL
 АНТИЧНЫЙ НИКЕЛЬ



(P)
 PATYNA
 PATINA
 ПАТИНА



(Z)
 ZŁOTO
 GOLD
 ЗОЛОТО



(ZM)
 ZŁOTO MATOWE
 MATT GOLD
 МАТОВОЕ ЗОЛОТО



Zeri

ZER-ZW-8 (P)

↓ 700 mm ↔ 880 mm

⊙ 8 x max 40W E14

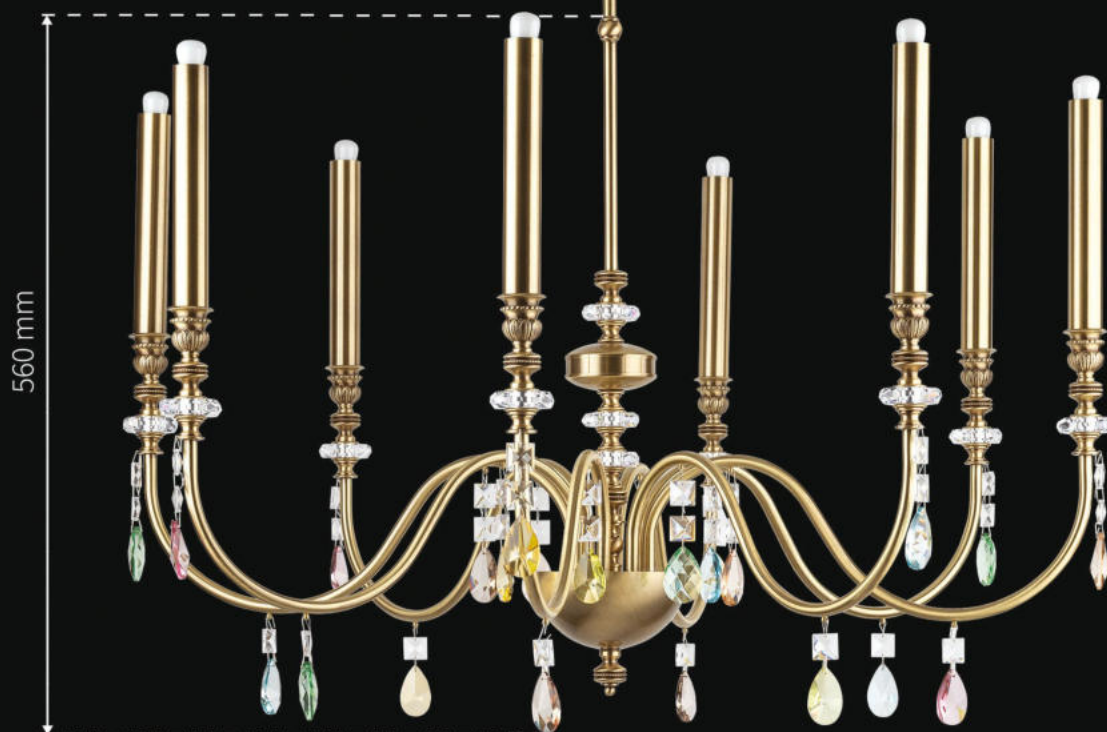

ZER-ZW-10 (N) T

↓ 700 mm ↔ 900 mm

⊙ 10 x max 40W E14



DOSTĘPNE KOLORY ABAŻURÓW



02



02-Z



02-S



03



03-Z



04



05



05-Z



05-S



10



10-Z



11

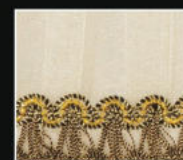

11-Z



12



12-Z



12-S



13



13-Z



14

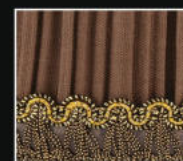

14-Z



15



15-Z



17



17-Z



18



18-Z



19



19-S



20



20-Z



20-S



21



21-Z



21-S



24

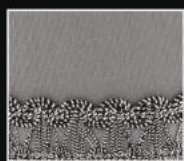

24-S



27



27-S



28



28-S

DOSTĘPNE KOLORY ABAŻURÓW



DOSTĘPNE ROZMIARY ABAŻURÓW

AVAILABLE SIZES OF LAMP SHADES
ŻYRANDOL / CHANDELIER / ЛЮСТРА

ДОСТУПНЫЕ РАЗМЕРЫ АВАРИЛЬНИКОВ
KINKIET / WALL LAMP / БРА

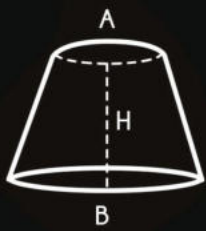

0

A = 90
B = 175
H = 110

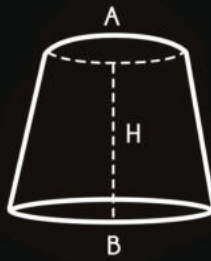

1

A = 120
B = 170
H = 140

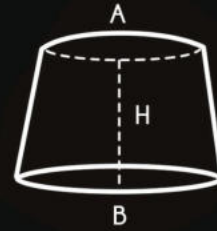

2

A = 150
B = 170
H = 120

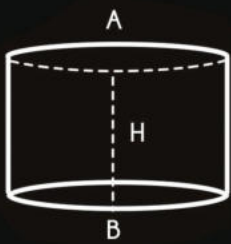

3

A = 175
B = 175
H = 120

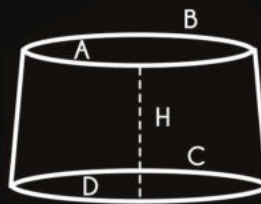

5

A = 120
B = 370
H = 250
D = 390
H = 150

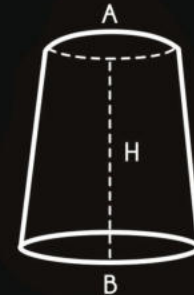

6

A = 100
B = 150
H = 160



8

A = 100
B = 100
H = 190



9

A = 120
B = 120
H = 210

ABAŻURY ZWD / ŻYRANDOL DUŻY / LARGE CHANDELIER / БОЛЬШАЯ ЛЮСТРА



10

A = 180
B = 180
H = 300

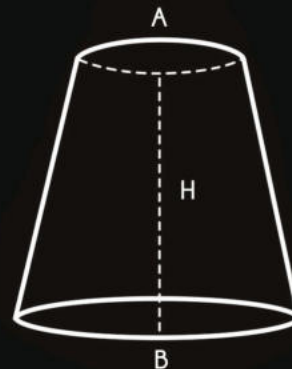

11

A = 180
B = 300
H = 270

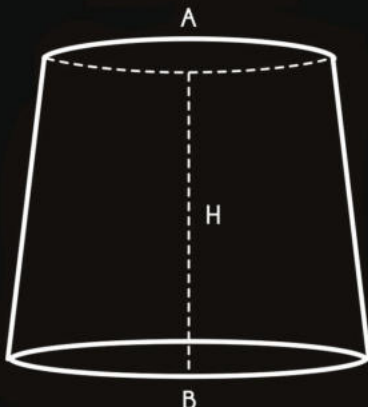

12

A = 300
B = 450
H = 400

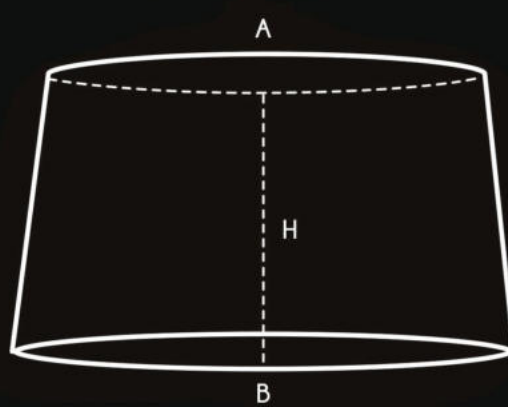

13

A = 550
B = 600
H = 300

DOSTĘPNE ROZMIARY ABAŻURÓW

AVAILABLE SIZES OF LAMPS SHADES / ДОСТУПНЫЕ РАЗМЕРЫ АВАРИЙ ЛАМП
LAMP GABINETOWA / DESK LAMP / НАСТОЛЬНАЯ ЛАМПА

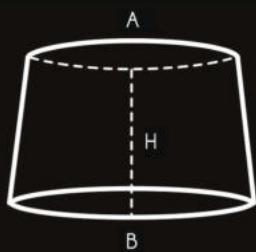

LG-L

A = 200
B = 300
H = 210

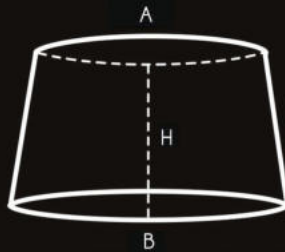

LG-C

A = 280
B = 320
H = 170

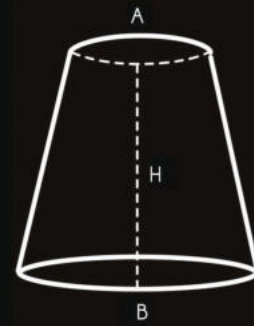

LG-N

A = 180
B = 300
H = 270



LG-T/180

A = 180
B = 180
H = 300

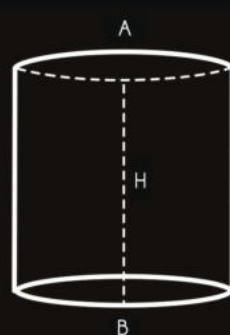

LG-T/250

A = 250
B = 250
H = 300

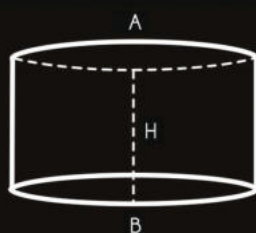

LG-W/180

A = 300
B = 300
H = 180

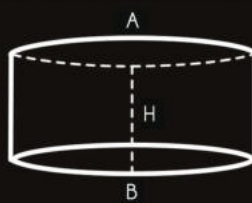

LG-W/130

A = 300
B = 300
H = 130

LAMPA STOJĄCA / FLOOR LAMP / ТОРШЕР

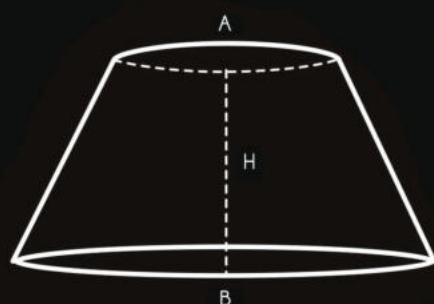

LS-L

A = 270
B = 530
H = 300

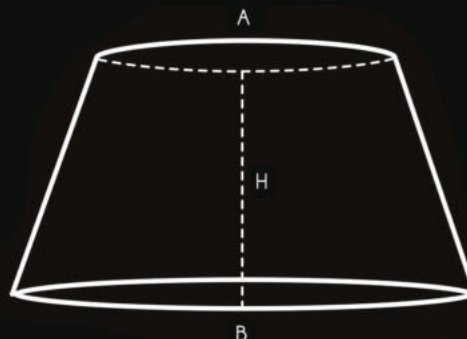

LS-M

A = 440
B = 550
H = 300

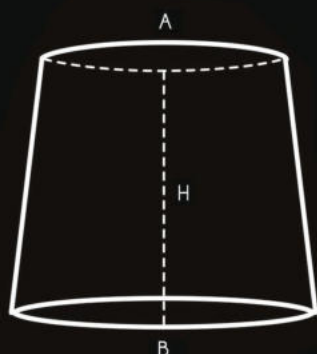

LS-N

A = 300
B = 450
H = 400

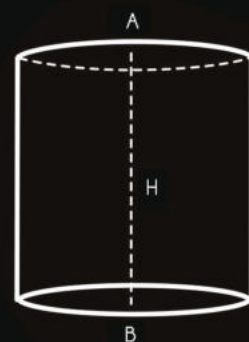

LS-T

A = 300
B = 300
H = 400

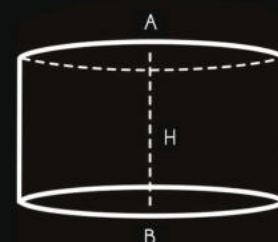

LS-W

A = 400
B = 400
H = 250



DESIGN & PRODUCTION
www.bastion-reklama.pl