NOTE LEGALI

Il presente catalogo contiene le rappresentazioni grafiche e i disegni di prodotti e/o di opere che sono protetti ai sensi delle norme nazionali e sovranazionali in tema di proprietà intellettuale e industriale.

© Tutti i diritti sono riservati.

Le rappresentazioni grafiche e i disegni di questi prodotti e/o opere non possono essere oggetto di utilizzo, di riproduzione, di comunicazione, di diffusione e/o di trasmissione in qualsiasi forma, in qualsiasi modo e/o con qualsiasi mezzo elettronico, meccanico o altro, nessuno escluso, senza l'autorizzazione espressa del proprietario dei diritti.

Alcuni dei prodotti e/o delle opere presentati in questo catalogo sono depositati come modelli industriali, disegni industriali e/o come marchi.

Ogni violazione sarà perseguita con ogni mezzo messo a disposizione dall'ordinamento giuridico italiano e internazionale.

LEGAL DISCLAIMER

This catalogue contains visual representations and drawings of products and/or works that are protected under national and international intellectual and industrial property law.

© All rights reserved.

The visual representations and drawings of these products and/or works are not to be utilised, reproduced, communicated, disseminated and/or transmitted in any form whatsoever, by any means – be it electronic, mechanical or otherwise – without the express authorisation of the owner of the rights.

Some of the products and/or works presented in this catalogue are registered as industrial models, industrial designs and/or trademarks. Any violation will be prosecuted by any means made available by the Italian and international legal system.

INDICE INDEX



AERON®
102



AERON FREE®
96

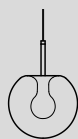

CHERRY®
54

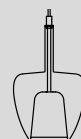

CLOS®
38



DALMA®
162



ECLISSE®
172

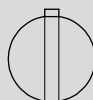

ECLISSE MAX®
182



FLUTE®
144

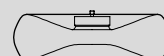

FOLD®
152



FREQUENCY®
68

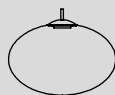

GEO®
190



HYDRA®
198



LACRIMA®
236



LA STILLA®
208



MARK®
112

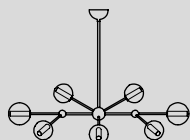

MIREA®
132



PARIGI®
244

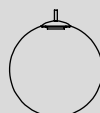

PIT®
80

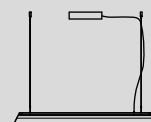

REGULA®
216



TAO®
126



VEGETAL®
226



ZOE®
18



ZOE MAX®
30



ZOE VGM®
254



Milan - Showroom

Cesena - Headquarter & Manufacturing

Cangini e Tucci, qualche dato.

Anno di fondazione: 1961

Brevetti depositati: 17

Sede: Via Archimede 36, 47521 - Cesena (FC)

Showroom: Presso Pacini & Cappellini - Via Albricci 7, 20122 - Milano (MI)

Cangini and Tucci, some facts.

Year founded: 1961

Patents: 17

Headquarters: Via Archimede 36, 47521 - Cesena (FC)

Showroom: Pacini & Cappellini - Via Albricci 7, 20122 - Milan (MI)

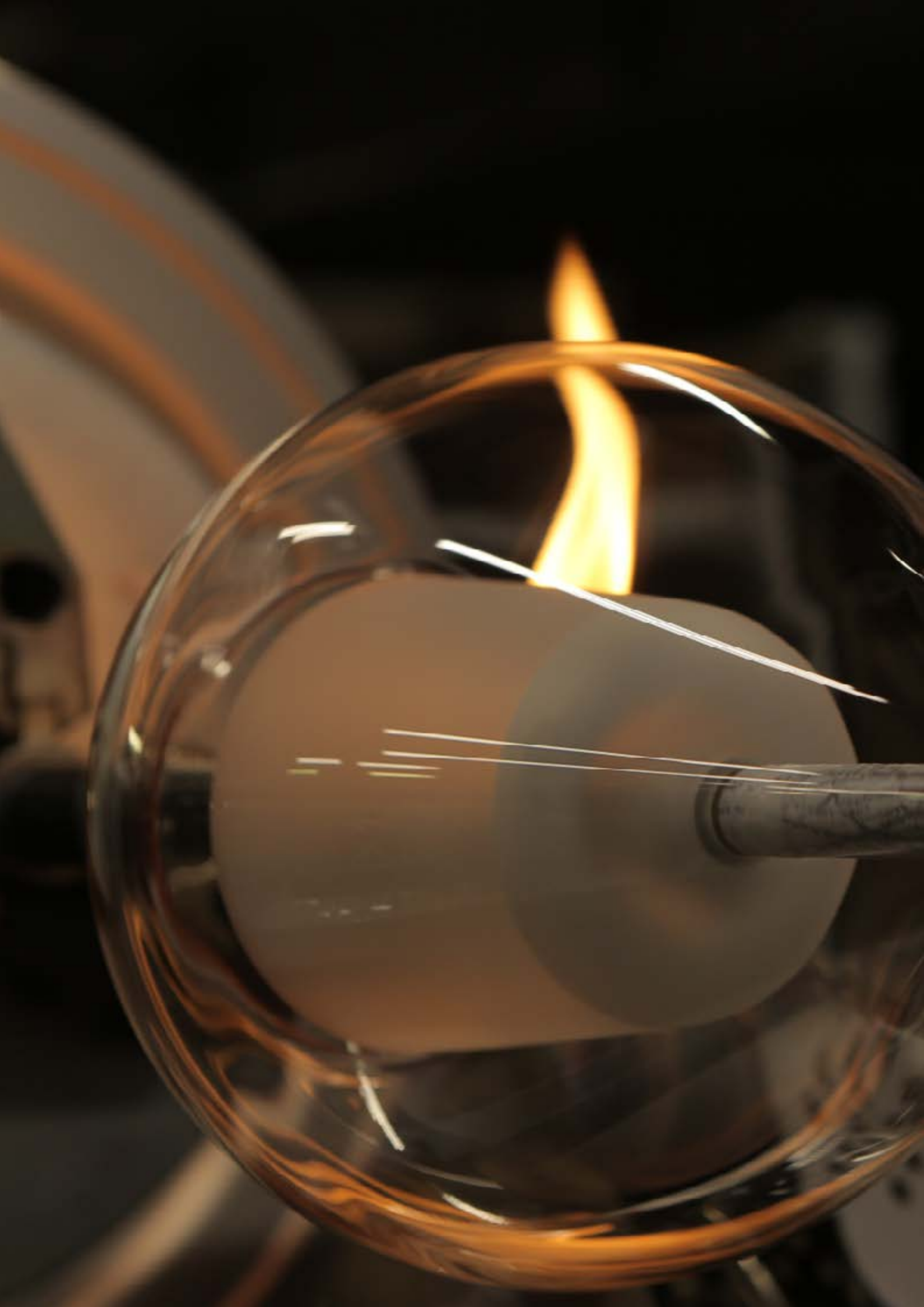

QUALITÀ MADE IN ITALY

QUALITY MADE IN ITALY

LE NOSTRE TECNICHE DI MAESTRIA NELLA LAVORAZIONE DEL VETRO, CHE SI TRAMANDANO DA OLTRE 60 ANNI, RAPPRESENTANO IL NOSTRO VALORE DISTINTIVO. A QUESTO SI AGGIUNGONO DEDIZIONE E ATTENZIONE AI DETTAGLI, CHE CI PERMETTONO DI RAGGIUNGERE UN UNICO OBIETTIVO: LA QUALITÀ. OGNI VETRO VIENE LAVORATO A MANO, RENDENDO OGNI PEZZO UN'OPERA UNICA. LA CURA NELLA SCELTA DEI MATERIALI, TRA CUI CAVI E PARTI METALLICHE DI ALTA QUALITÀ, LED PERSONALIZZATI E DI LIVELLO SUPERIORE, E UN IMBALLAGGIO SICURO E AFFIDABILE, SONO ELEMENTI FONDAMENTALI DEL NOSTRO PROCESSO. INOLTRE, OFFRIAMO UN SERVIZIO DI SUPPORTO ATTENTO E PUNTUALE, CHE COMPLETA IL NOSTRO IMPEGNO FINALIZZATO A SODDISFARE A PIENO CHI ACQUISTA UNA NOSTRA CREAZIONE.

OUR MASTERLY GLASS PROCESSING TECHNIQUES, WHICH HAVE BEEN HANDED DOWN FOR OVER 60 YEARS, REPRESENT OUR DISTINCTIVE VALUE. TO THIS WE ADD DEDICATION AND ATTENTION TO DETAIL, WHICH ALLOWS US TO ACHIEVE A SINGLE GOAL: QUALITY. EACH PIECE OF GLASS IS HANDCRAFTED, MAKING EACH PIECE UNIQUE. CAREFUL SELECTION OF MATERIALS, INCLUDING HIGH-QUALITY CABLES AND METAL PARTS, CUSTOMISED AND SUPERIOR LEDS, AND SAFE AND RELIABLE PACKAGING ARE KEY ELEMENTS OF OUR PROCESS. IN ADDITION, WE OFFER AN EXPERIENCED AND DEDICATED SUPPORT SERVICE, WHICH COMPLEMENTS OUR COMMITMENT TO FULLY SATISFYING THOSE WHO PURCHASE ONE OF OUR CREATIONS.

A hand holds a glowing, translucent fabric piece against a dark background. The fabric is illuminated from below, creating a bright, ethereal glow. In the background, a sewing machine is partially visible, suggesting a tailoring or fashion design context.

LUCE SU MISURA

LIGHT TAILORING

A close-up, low-angle shot of a person's hands working on a glass lamp. The person is wearing a white t-shirt and is focused on their work. The background is dark, with some blurred lights, suggesting a workshop or studio environment. The lighting is warm and focused on the hands and the glass object.

OFFRIAMO UNA VASTA SELEZIONE DI COLLEZIONI, CON DIVERSE OPZIONI DI INSTALLAZIONE, E NUMEROSE POSSIBILITÀ DI PERSONALIZZAZIONE. GRAZIE ALLA NOSTRA AMPIA GAMMA DI COLORI PER I VETRI E ALLE VARIE POSSIBILITÀ DI FINITURA DELLE SUPERFICI METALLICHE, OGNI PRODOTTO PUÒ ESSERE ADATTATO ALLE SPECIFICHE ESIGENZE. INOLTRE, SUPPORTIAMO I NOSTRI CLIENTI NELLO SVILUPPO DI SOLUZIONI, SIA SEMPLICI CHE COMPLESSE, ATTRAVERSO DISEGNI 3D E VISUALIZZAZIONI PERSONALIZZATE, STUDIATE IN BASE ALLE NECESSITÀ DI DESIGN E ILLUMINOTECNICHE DELLO SPAZIO (MAGGIORI DETTAGLI DA PAG. 300).

WE OFFER A WIDE SELECTION OF COLLECTIONS, WITH DIFFERENT INSTALLATION OPTIONS, AND MULTIPLE CUSTOMISATION POSSIBILITIES. THANKS TO OUR WIDE RANGE OF GLASS COLOURS AND VARIOUS METAL SURFACE FINISH OPTIONS, EACH PRODUCT CAN BE ADAPTED TO SPECIFIC NEEDS. IN ADDITION, WE SUPPORT OUR CUSTOMERS IN DEVELOPING SOLUTIONS, BOTH SIMPLE AND COMPLEX, THROUGH 3D DRAWINGS AND CUSTOM VISUALISATIONS, TAILORED TO THE DESIGN AND LIGHTING NEEDS OF THE SPACE (MORE DETAILS FROM PAGE 300).



DECORAZIONE E METALLIZZAZIONE

METALLIZATION

IL PROCESSO DI METALLIZZAZIONE VIENE ESEGUITO CON METODO ARTIGIANALE. PICCOLE IMPERFEZIONI PIÙ O MENO EVIDENTI SONO INEVITABILI E NE ATTESTANO, VALORIZZANDOLA, L'ESECUZIONE MANUALE. NON PREVEDENDO L'UTILIZZO DI CODICI RAL, IL PROCESSO PUÒ DARE LUOGO A DIFFERENTI TONALITÀ DI COLORE CHE POSSONO CAMBIARE DA UNA FASE DI LAVORAZIONE ALL'ALTRA A DISTANZA DI TEMPO.

L'AZIENDA RISERVA E GARANTISCE UN ATTENTO CONTROLLO DI QUALITÀ.

METALLIZATION PROCESS IS HANDCRAFTED, SMALL IMPERFECTIONS ARE INEVITABLE AND THEY ATTEST THE MANUAL EXECUTION OF TECHNIQUE. THE PROCESS DOES NOT USE RAL CODES, THEREFORE THIS CAN GIVE RISE TO DIFFERENT SHADES OF COLOUR THAT CAN CHANGE FROM A PHASE OF PRODUCTION TO ANOTHER IN A DISTANCE OF TIME. THE COMPANY RESERVES AND GUARANTEES A CAREFUL QUALITY CONTROL.

PROGETTO E INNOVAZIONE

DESIGN AND INNOVATION



LA NOSTRA PASSIONE PER IL MESTIERE E IL CONTINUO DESIDERIO DI INNOVAZIONE CI SPINGONO A CREARE NUOVI MODELLI CHE RISPONDANO ALLE TENDENZE DEL MERCATO, SENZA MAI PERDERE DI VISTA L'ORIGINALITÀ. GRAZIE ALLE NOSTRE COMPETENZE NELLA LAVORAZIONE DEL VETRO E ALL'IMPIEGO DI TECNOLOGIA LED AVANZATA, CON CIRCUITI PERSONALIZZATI E REALIZZATI IN ITALIA, GARANTIAMO SOLUZIONI DI ALTISSIMA QUALITÀ RISPETTANDO LE NECESSITÀ DI STILE E DI PERFORMANCE LUMINOSA.

OUR PASSION FOR THE CRAFT AND CONTINUOUS DESIRE FOR INNOVATION DRIVE US TO CREATE NEW MODELS THAT RESPOND TO MARKET TRENDS, WITHOUT EVER LOSING SIGHT OF ORIGINALITY. THANKS TO OUR EXPERTISE IN GLASS PROCESSING AND THE USE OF ADVANCED LED TECHNOLOGY, WITH CUSTOMISED CIRCUITS MADE IN ITALY, WE GUARANTEE TOP-QUALITY SOLUTIONS IN TERMS OF DESIGN AND LIGHTING PERFORMANCE.

PERSONALIZZAZIONE DELLE FINITURE

FINISHING CUSTOMISATION

TUTTI I NOSTRI PRODOTTI SONO ACCOMPAGNATI DA UN CERTIFICATO DI GARANZIA CHE NE ATTESTA L'ORIGINALITÀ, LA MANIFATTURA ITALIANA E LA QUALITÀ. IMPERFEZIONI DEL CRISTALLO, DEL COLORE, DEL CAMBIO DI TONALITÀ NON VENGONO CONSIDERATE DIFETTI MA PREGI, CHE NE GARANTISCONO L'AUTENTICITÀ RENDENDO IL PEZZO UNICO.

ALL OUR PRODUCTS ARE PROVIDED OF A WARRANTY CERTIFICATE THAT AUTHENTICATES THEIR ORIGINALITY, ITALIAN MANUFACTURING AND QUALITY OF THE PRODUCT.

IMPERFECTIONS IN THE CRYSTAL OR COLOUR (OR CHANGES OF TONALITY) ARE NOT DEFECTIVE. EACH HAS PARTICULAR FEATURES THAT GUARANTEE THEIR AUTHENTICITY AND OFFER OUR ESTEEMED CUSTOMERS A OPPORTUNITY TO OWN A UNIQUE PRODUCT TO TREASURE.



NELLE PAGINE A SEGUIRE SI POSSONO TROVARE LE OPZIONI DISPONIBILI PER LE FINITURE DEI VETRI E DELLE PARTI METALLICHE. DURANTE LA SELEZIONE, SI PREGA DI PRESTARE ATTENZIONE AI SEGUENTI PUNTI:

- NON TUTTE LE FINITURE SONO STANDARD PER OGNI MODELLO (VERIFICARE LE RELATIVE COLLEZIONI)
- I PREZZI POSSONO VARIARE IN BASE ALLE FINITURE (CONSULTARE IL LISTINO)
- IN CASO DI RICHIESTE SPECIALI RIVOLGERSI AL NOSTRO UFFICIO TECNICO

ON THE FOLLOWING PAGES YOU WILL FIND THE AVAILABLE OPTIONS FOR GLASS AND METAL PART COLOUR FINISHES. WHEN MAKING YOUR SELECTION, PLEASE PAY ATTENTION TO THE FOLLOWING POINTS:

- *NOT ALL FINISHES ARE STANDARD FOR EACH MODEL (PLEASE CHECK THE COLLECTIONS)*
- *PRICES MAY CHANGE DEPENDING ON FINISHES (PLEASE CONSULT THE PRICELIST)*
- *FOR SPECIAL REQUESTS PLEASE CONTACT OUR TECHNICAL DEPARTMENT*

COLORI, MATERIALI E FINITURE

COLOURS, MATERIALS AND FINISHES

COLORI DISPONIBILI VETRI

GLASS COLOURS AVAILABLE



01 - Trasparente
Transparent



03 - Rosa
Pink



05 - Ambra
Amber



06 - Verde
Green



07 - Azzurro
Sky-Blue



08 - Fumè
Fume



16 - Tabacco
Tobacco



17 - Rubino
Ruby

COLORI FINITURE STRUTTURA / CORPO METALLICO DISPONIBILI

AVAILABLE METALLIC FINISHES FOR METAL BODY / STRUCTURE



Cromo
Chrome



Cromo spazzolato
Brushed chrome

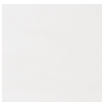

Bianco opaco
Matt white



Nero opaco
Matt black

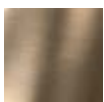

Oro satinato
Satin gold

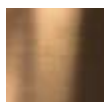

Oro rosa
Satinato
Satin rose gold

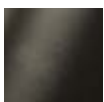

Nichel nero
Satinato
Satin black nickel



Champagne
Champagne



French gold
French gold





























Black carbon
Black carbon

VERIFICARE LA DISPONIBILITÀ DEI COLORI PER LE RISPETTIVE COLLEZIONI
PLEASE CHECK THE AVAILABILITY OF COLOURS FOR THE RELEVANT COLLECTIONS

COLORI METALLICI VETRO DISPONIBILI
METALLIC GLASS COLOURS AVAILABLE

MODELLO / MODEL COLORI / COLOURS

CHERRY	 Bronzo Bronze	 Nero Black	 Verde Ottanio Teal green			
CLOS	 Bronzo Bronze	 Nero Black	 Verde Ottanio Teal green			
ECLISSE Ø14 CM	 Acciaio Steel	 Bronzo Bronze	 Nero Black	 Oro Gold	 Oro rosa Rose gold	
ECLISSE MAX	 Acciaio Steel	 Bronzo Bronze	 Nero Black			
FLUTE	 Bronzo Bronze	 Nero Black	 Titanio Titanium			
TAO	 Oro rosa Rose gold	 Titanio Titanium				
ZOE	 Bronzo Bronze	 Lapsus Lapsus	 Nero Black	 Petrolio Petroleum	 Titanio Titanium	 Verde Ottanio Teal green
ZOE MAX	 Bronzo Bronze	 Nero Black				

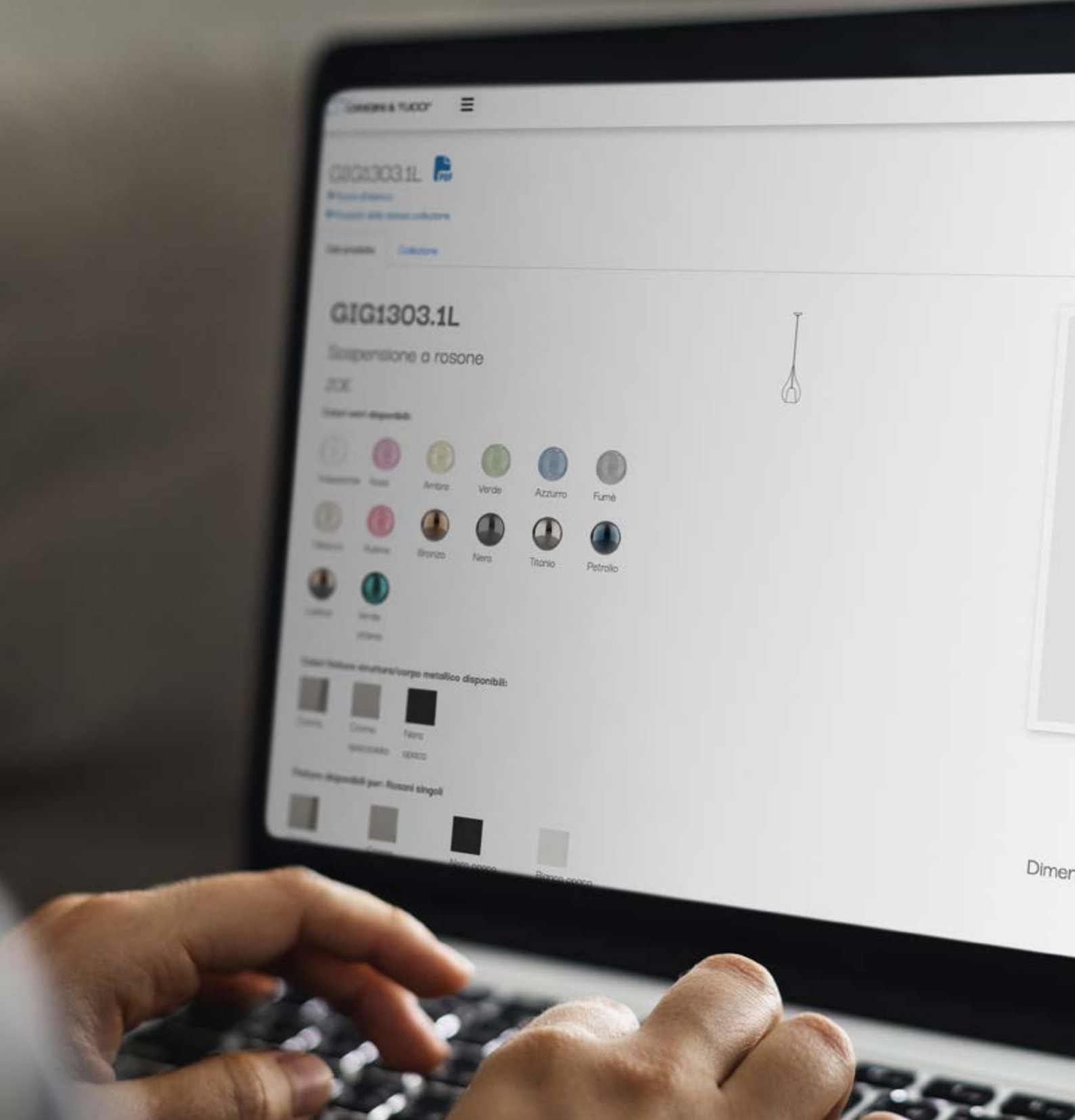

IL PIM

PRODUCT INFORMATION MANAGEMENT

PER APPROFONDIRE
FOR MORE DETAILS

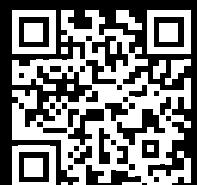



IL PIM È UN SISTEMA CHE RAGGRUPPA E ORGANIZZA IN MANIERA COERENTE LE TANTE INFORMAZIONI DI PRODOTTO. LA NOSTRA PIATTAFORMA PERMETTE UN'ESPERIENZA DIGITALE CENTRALIZZATA DOVE REPERIRE INFORMAZIONI CORRETTE E SEMPRE AGGIORNATE. SARÀ POSSIBILE SCARICARE LE SCHEDE TECNICHE, LE IMMAGINI, I MODELLI 3D E TANTO ALTRO.

PIM IS A SYSTEM ABLE TO COHERENTLY ORGANISE PRODUCT INFORMATION. OUR PLATFORM PROVIDES A CENTRALISED DIGITAL EXPERIENCE WHERE YOU CAN FIND THE CORRECT AND ALWAYS UPDATED INFORMATION. IT IS POSSIBLE TO DOWNLOAD DATA SHEETS, PICTURES, 3D MODELS AND MUCH MORE.



ZOE[®]

DESIGN: PIETRO TUCCI (2014)



1309MX.3L
Glass: *lapses*
Plate: *chrome*



GIG1307.120.3L
Glass: teal green
Track: matt black



1303
GIG1303
XXL1303
Glass: black, bronze, titanium



LUGI1303
 Glass: bronze
 Shade: black/gold

LUXXL1303
 Glass: black
 Shade: white/silver

PARALUMI CINETTE DISPONIBILI PER LA LINEA ZOE
 CINETTE LAMPSHADES AVAILABLE FOR ZOE

CI - BIANCO / ARGENTO
 CI - WHITE / SILVER



CI - BIANCO / ORO
 CI - WHITE / GOLD



CI - NERO / ARGENTO
 CI - BLACK / SILVER



CI - NERO / ORO
 CI - BLACK / GOLD





1303
GIG1303
XXL1303
Glass: black, bronze, titanium





COLORI, MATERIALI, FINITURE / CMF

COLORI VETRO DISPONIBILI / AVAILABLE GLASS COLOURS



01 - Trasparente
Transparent



03 - Rosa
Pink



05 - Ambra
Amber



06 - Verde
Green



07 - Azzurro
Sky-Blue



08 - Fumè
Fume



16 - Tabacco
Tobacco



17 - Rubino
Ruby

COLORI VETRO METALLIZZATO DISPONIBILI / METALLIC GLASS COLOURS AVAILABLE



Bronzo
Bronze



Nero
Black



Titanio
Titanium



Petrolio
Petroleum



Lapsus
Lapsus



Verde ottanio
Teal green

NEW

FINITURA STRUTTURA/ CORPO METALLICO A VISTA DISPONIBILE / AVAILABLE METALLIC FINISHES FOR METAL-BODY-STRUCTURE



Cromo
Chrome



Cromo spazzolato
Brushed chrome



Nero opaco
Matt black

FINITURA DISPONIBILE PER: PIASTRE, BINARI E DISASSATORI / FINISH AVAILABLE FOR: PLATES, TRACKS AND SPACERS



Cromo
Chrome



Cromo spazzolato
Brushed chrome



Nero opaco
Matt black



Bianco opaco
Matt white

CARATTERISTICHE TECNICHE / TECHNICAL FEATURES

MATERIALI: VETRO BOROSILICATO E OTTONE / MATERIALS: BOROSILICATE GLASS AND BRASS

CAVO ELETTRICO TRASPARENTE O TESSILE NERO / TRANSPARENT ELECTRIC CABLE OR BLACK TEXTILE

PARALUME CINETTE DISPONIBILE PER LU1303, LUGIG1303 E LUXXL1303: CI-BIANCO-ARGENTO, CI-BIANCO-ORO, CI-NERO-ARGENTO, CI-NERO-ORO / AVAILABLE FOR LU1303, LUGIG1303 AND LUXXL1303: CI-WHITE-SILVER, CI-WHITE-GOLD, CI-BLACK-SILVER, CI-BLACK-GOLD

SORGENTE LUMINOSA / LIGHTING SOURCE:

- E14, E27, G9, LED (IN BASE ALLA TIPOLOGIA / DEPENDING ON TYPE)
- LAMPADINA NON INCLUSA / BULB NOT INCLUDED

• LED DISPONIBILE PER LAMPADE DA TAVOLO CON PARALUME / LED AVAILABLE FOR TABLE LAMPS WITH SHADE:

LED 1x 3,5W - 220,0V-240,0V - 350 Lm - 180°-3000K (I LUMEN INDICATI CORRISPONDONO ALL'INTENSITÀ LUMINOSA

ALL'ORIGINE DELLA SCHEDA LED / LUMEN INDICATED CORRESPONDS TO THE LUMINOUS INTENSITY AT THE ORIGIN OF THE LED BOARD)

ON DEMAND / OPTIONAL FEATURES

- PERSONALIZZAZIONE LUNGHEZZA DEL CAVO SU RICHIESTA / CUSTOMISED CABLE LENGTH ON REQUEST
- A RICHIESTA CON COMPONENTI UL / ON DEMAND WITH UL COMPONENTS
- TIGE INTERNA A RICHIESTA NERO OPACO (STANDARD CROMO) / INNER METAL TUBE, ON DEMAND MATT BLACK (STANDARD CHROME)

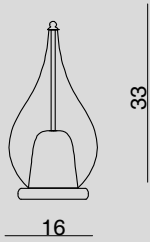

LU1300

LAMPADA DA TAVOLO / TABLE LAMP
 Glass 1 x Ø 16 cm - Cable 200 cm
 1 x G9 33 W

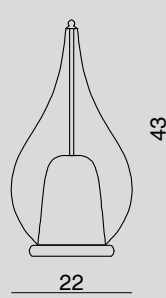
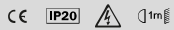

LUG1300

LAMPADA DA TAVOLO / TABLE LAMP
 Glass 1 x Ø 22 cm - Cable 200 cm
 1 x E27 60 W

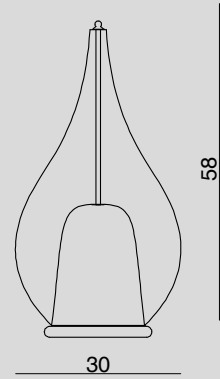
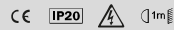

LUXXL1300

LAMPADA DA TAVOLO / TABLE LAMP
 Glass 1 x Ø 30 cm - Cable 200 cm
 1 x E27 60 W

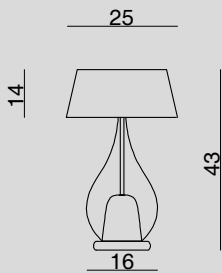
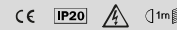

LU1303

LAMPADA DA TAVOLO / TABLE LAMP
 Glass 1 x Ø 16 cm - Cable 200 cm
 1 x E14 40 W - 1 x LED 3,5 W DIMM

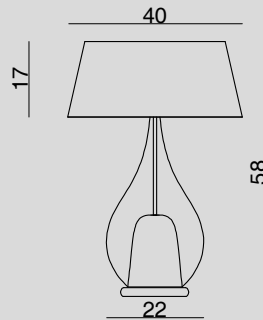
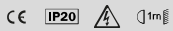

LUG1303

LAMPADA DA TAVOLO / TABLE LAMP
 Glass 1 x Ø 22 cm - Cable 200 cm
 1 x E27 60 W - 1 x LED 3,5 W DIMM

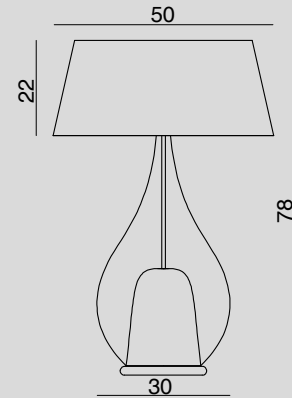
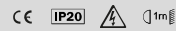

LUXXL1303

LAMPADA DA TAVOLO / TABLE LAMP
 Glass 1 x Ø 30 cm - Cable 200 cm
 1 x E27 60 W - 1 x LED 3,5 W DIMM

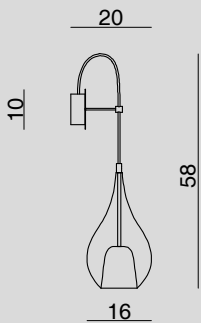
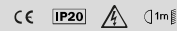

AP1301.1L

APPLIQUE / WALL LAMP
 Glass 1 x Ø 16 cm - Cable 50 cm
 1 x E14 60 W

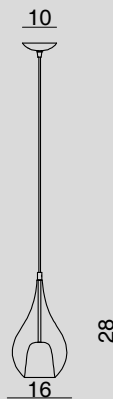
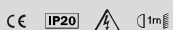

1303.1L

SOSPENSIONE A ROSONE / HANGING LAMP WITH CANOPY
 Glass 1 x Ø 16 cm - Cable 150 cm
 1 x E14 60 W

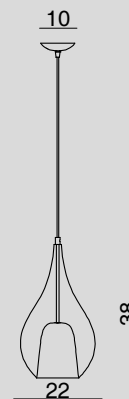
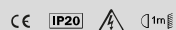

GIG1303.1L

SOSPENSIONE A ROSONE / HANGING LAMP WITH CANOPY
 Glass 1 x Ø 22 cm - Cable 150 cm
 1 x E27 105 W



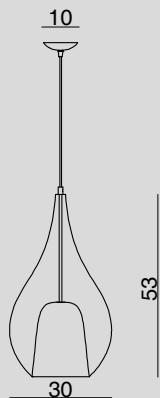

XXL1303.1L

SOSPENSIONE A ROSONE / HANGING LAMP WITH CANOPY

Glass 1 x Ø 30 cm - Cable 150 cm

1 x E27 105 W

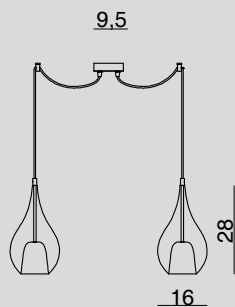
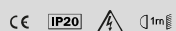

1303.2L

SOSPENSIONE A ROSONE / HANGING LAMP WITH CANOPY

Glass 2 x Ø 16 cm - Cable 250 cm

2 x E14 60 W

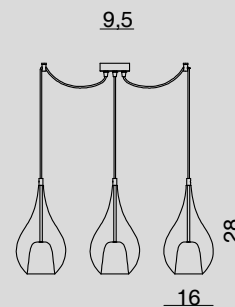
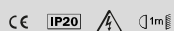

1303.3L

SOSPENSIONE A ROSONE / HANGING LAMP WITH CANOPY

Glass 3 x Ø 16 cm - Cable 250 cm

3 x E14 60 W

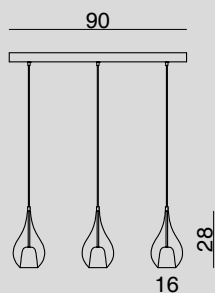
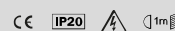

1307.90.3L

SOSPENSIONE A BINARIO / HANGING LAMP WITH TRACKS

Glass 3 x Ø 16 cm - Cable 150 cm

3 x E14 60 W

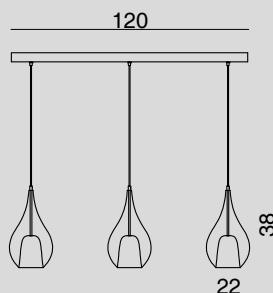
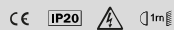

GIG1307.120.3L

SOSPENSIONE A BINARIO / HANGING LAMP WITH TRACKS

Glass 3 x Ø 22 cm - Cable 150 cm

3 x E27 105 W

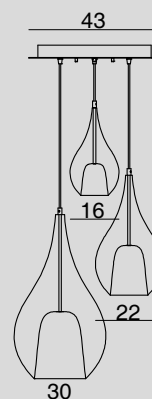
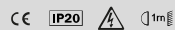

1309MX.3L

SOSPENSIONE A PIASTRA / HANGING LAMP WITH CEILING PLATE

Glass 3 x Ø 16-22-30 cm cm - Cable 150 cm

1 x E14 60 W - 2 x E27 105 W

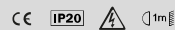

DETTAGLI PRODOTTO
PRODUCT DETAILS

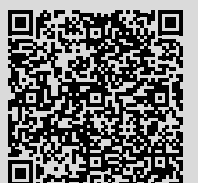





ZOE[®] MAX

DESIGN: PIETRO TUCCI (2021)





ZOE MAX È UNA LAMPADA A SOSPENSIONE IN VETRO SOFFIATO ED È L'ULTIMA ARRIVATA DELLA FAMIGLIA ZOE. CON UN DIAMETRO DI 45 CM DI E UN'ALTEZZA DI 80 CM È UNA DELLE LAMPADE PIÙ GRANDI REALIZZATE DA CANGINI E TUCCI. IL DESIGN È LO STESSO DI SEMPRE, ICONICO, SEMPLICE MA ALLO STESSO TEMPO ELEGANTE E SENZA TEMPO. ZOE MAX PUÒ ESSERE INSTALLATA SOPRA UN TAVOLO DA PRANZO, IN UN VANO SCALA, A FIANCO DI UN SOPPALCO SU UN DOPPIO VOLUME. LE DIMENSIONI GENEROSE SONO PERFETTE PER RIEMPIRE UN VUOTO ALL'INTERNO DI UNO SPAZIO ARCHITETTONICO O PER DEFINIRE UN'AREA ALL'INTERNO DI UNO SPAZIO PIÙ AMPIO, AD ESEMPIO SOPRA UN TAVOLO ALL'INTERNO DI UN RISTORANTE. IL VETRO ESTERNO DI ZOE MAX PUÒ ESSERE REALIZZATO IN DIVERSE FINITURE E COLORI: CON EFFETTO METALLIZZATO O CON COLORAZIONE SEMPLICE, LA PARTE INTERNA DEL VETRO È IN VETRO SATINATO.

ZOE MAX IS A BLOWN GLASS PENDANT LAMP AND IS THE LATEST ADDITION TO THE ZOE FAMILY. WITH A DIAMETER OF 45 CM AND A HEIGHT OF 80 CM IT IS ONE OF THE LARGEST LAMPS MADE BY CANGINI AND TUCCI. THE DESIGN IS THE SAME AS ALWAYS, ICONIC, SIMPLE BUT AT THE SAME TIME ELEGANT AND TIMELESS. ZOE MAX CAN BE INSTALLED ABOVE A DINING TABLE, IN A STAIRWELL, ALONGSIDE A LOFT ON A TWO STOREY INTERIOR. THE GENEROUS SIZE IS PERFECT FOR FILLING A VOID WITHIN AN ARCHITECTURAL SPACE OR FOR DEFINING AN AREA WITHIN A LARGER SPACE, SUCH AS ABOVE A TABLE WITHIN A RESTAURANT. THE EXTERNAL GLASS OF ZOE MAX CAN BE MADE IN DIFFERENT FINISHES AND COLORS: WITH A METALLIC EFFECT OR WITH A SIMPLE COLORING, THE INTERNAL PART OF THE GLASS IS SATIN GLASS.





MAX1303.1L
Glass: bronze



MAX1303.1L
Glass: transparent



COLORI, MATERIALI, FINITURE / CMF

COLORI VETRO DISPONIBILI / AVAILABLE GLASS COLOURS



01 - Trasparente
Transparent



03 - Rosa
Pink



05 - Ambra
Amber



06 - Verde
Green



07 - Azzurro
Sky-Blue



08 - Fumè
Fume



16 - Tabacco
Tobacco



17 - Rubino
Ruby

COLORI VETRO METALLIZZATO DISPONIBILI / METALLIC GLASS COLOURS AVAILABLE



Bronzo
Bronze



Nero
Black

FINITURA STRUTTURA/CORPO METALLICO A VISTA DISPONIBILE / AVAILABLE METALLIC FINISHES FOR METAL-BODY-STRUCTURE



Cromo
Chrome



Cromo spazzolato
Brushed chrome



Nero opaco
Matt black

FINITURA DISPONIBILE PER: PIASTRE, BINARI E DISASSATORI / FINISH AVAILABLE FOR: PLATES, TRACKS AND SPACERS



Cromo
Chrome



Cromo spazzolato
Brushed chrome



Nero opaco
Matt black



Bianco opaco
Matt white

CARATTERISTICHE TECNICHE / TECHNICAL FEATURES

MATERIALI: VETRO BOROSILICATO E OTTONE / MATERIALS: BOROSILICATE GLASS AND BRASS

CAVO ELETTRICO TRASPARENTE O NERO / TRANSPARENT ELECTRIC CABLE OR BLACK

SORGENTE LUMINOSA / LIGHTING SOURCE:

- E27
- LAMPADINA NON INCLUSA / BULB NOT INCLUDED
- SI CONSIGLIA: LAMPADINA E27 LED 25w 2250 lm Ø140 mm (NON INCLUSA) / WE RECOMMEND: LED BULB E27 LED 25w 2250 lm Ø140 mm (NOT INCLUDED)

ON DEMAND / OPTIONAL FEATURES

- PERSONALIZZAZIONE LUNGHEZZA DEL CAVO SU RICHIESTA / CUSTOMISED CABLE LENGTH ON REQUEST
- A RICHIESTA CON COMPONENTI UL / ON DEMAND WITH UL COMPONENTS
- TIGE INTERNA A RICHIESTA NERO OPACO (STANDARD CROMO) / INNER METAL TUBE, ON DEMAND MATT BLACK (STANDARD CHROME)

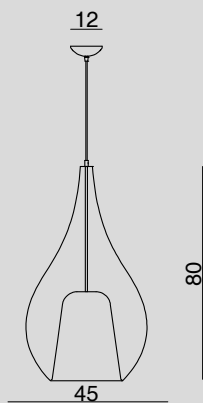

MAX1303.1L

SOSPENSIONE A ROSONE / HANGING LAMP
WITH CANOPY

Glass 1 x Ø 45 cm - Cable 150 cm

1 x E27 105 W

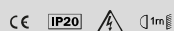

! GUIDA CARATTERISTICA METALLIZZAZIONE

Zoe Max è una lampada interamente realizzata a mano. Il processo necessario a realizzare a mano una lampada di queste dimensioni è molto complesso e richiede ore di lavorazione da parte di operai specializzati nella soffiatura del vetro. Su una superficie di queste dimensioni può capitare che si verifichino delle piccole imperfezioni, soprattutto in fase di finitura o durante la metallizzazione. Tali imperfezioni attestano che il prodotto è realizzato con procedure artigianali e aumentano ulteriormente il valore della lampada. L'azienda Cangini e Tucci non accetta nessun tipo di contestazione sulle eventuali micro-imperfezioni superficiali che dovesse presentare la lampada. (vedi riferimento brochure a riguardo)

! GUIDE TO THE METALLISATION CHARACTERISTIC

Zoe Max is a lamp made entirely by hand. The process involved in manually producing a lamp of this size is very complex and requires hours of labour performed by skilled glassblowers. On a surface of such an extent, small imperfections may occur, especially during the finishing or metallisation process. Such imperfections attest to the fact that the product is handcrafted and further increase the value of the lamp. The Cangini e Tucci company does not accept any complaints regarding micro-imperfections on the lamp surface. (Please refer to the specific brochure of reference.)

! LEITFADEN FÜR METALLISIERUNGSMERKMALE

Zoe Max ist eine vollständig von Hand gefertigte Lampe. Die handwerkliche Herstellung einer Lampe dieser Größe ist sehr komplex und erfordert stundenlange Arbeit der Glasbläser. Auf einer Oberfläche dieser Größe können kleine Unregelmäßigkeiten auftreten, insbesondere in der Endbearbeitung oder während der Metallisierung. Diese Unvollkommenheiten beweisen, dass es sich um ein handgefertigtes Produkt handelt, und erhöhen den Wert der Lampe. Die Firma Cangini e Tucci akzeptiert keine Reklamationen bezüglich oberflächlicher Mikrofehler, die die Lampe aufweisen kann. (siehe Referenzbrochure)



NEW

CLOS[©]

DESIGN: PIETRO TUCCI (2025)



CLOS, DESIGN BY PIETRO TUCCI, IS A COLLECTION OF LAMPS DESIGNED TO CELEBRATE THE ELEGANCE OF WINE AND THE WARMTH OF HOSPITALITY. ITS NAME RECALLS THE FRENCH VINEYARDS ENCLOSED BY ANCIENT DRY-STONE WALLS, PLACES WHERE THE LAND PRESERVES AND PROTECTS THE FRUIT OF THE VINE.

CRAFTED WITH THE SAME ARTISANAL EXPERTISE AS WINE GLASSES AND DECANTERS, THE HAND-BLOWN GLASS OF CLOS DIFFUSES A SOFT AND REFINED LIGHT. ITS TRANSPARENT HUES, AVAILABLE IN SOPHISTICATED SHADES, CREATE ENCHANTING REFLECTIONS THAT ENHANCE ANY SPACE, WHILE THE INNER DIFFUSER ENSURES A GENTLE AND EMBRACING ILLUMINATION.

PERFECT FOR CONVIVIAL SETTINGS AND INTIMATE ATMOSPHERES, CLOS IS MORE THAN JUST A LAMP: IT IS A TRIBUTE TO TRADITION, THE JOY OF SHARING, AND THE TIMELESS BEAUTY OF GLASS.

CLOS, DESIGN BY PIETRO TUCCI, È UNA COLLEZIONE DI LAMPADE NATA PER CELEBRARE L'ELEGANZA DEL VINO E IL CALORE DELL'ACCOGLIENZA.

IL SUO NOME RICHIAMA I VIGNETI FRANCESI RACCHIUSI DA ANTICHI MURETTI A SECCO, LUOGHI IN CUI LA TERRA CUSTODISCE E PROTEGGE IL FRUTTO DELLA VITE. LAVORATO CON LA STESSA MAESTRIA ARTIGIANALE DEI CALICI E DEI DECANTER, IL VETRO SOFFIATO DI CLOS DIFFONDE UNA LUCE MORBIDA E RAFFINATA. LE SUE TRASPARENZE, DECLINATE IN TONALITÀ SOFISTICATE, CREANO GIOCHI DI RIFLESSI CHE ARRICCHISCONO OGNI AMBIENTE, MENTRE IL DIFFUSORE INTERNO GARANTISCE UN'ILLUMINAZIONE DELICATA E AVVOLGENTE.

PERFETTA PER SPAZI CONVIVIALI E ATMOSFERE INTIME, CLOS È PIÙ DI UNA LAMPADA: È UN RICHIAMO ALLA TRADIZIONE, AL PIACERE DELLA CONDIVISIONE E ALLA BELLEZZA SENZA TEMPO DEL VETRO.



LUGIG1680.1L
Glass: amber
Structure: french gold
with dimmer push button

9x INC4,5 recessed canopies
matt white finish

4x 1683

4x GIG1683

1x XXL1683

Glass: bronze, black, teal green





LU1685.1L

Glass: amber

Structure: french gold
with dimmer push button



7x **GIG1683.1L**
8x **XXL1683.1L**
Glass: bronze, black, amber, fume
Structure: black carbon



AP1681.1L
Glass: bronze
Structure: french gold

MAX1683.1L
Glass: teal green
Structure: black carbon





Track **AUF150**
french gold finish

2x **1683**

2x **GIG1683**

1x **XXL1683**

Glass: black, teal green, bronze
Structure: french gold



LU1685.1L

Glass: teal green

*Structure: french gold
with dimmer push button*



LU1685.1L

Glass: bronze

*Structure: black carbon
with dimmer push button*



COLORI, MATERIALI, FINITURE / CMF

COLORI VETRO DISPONIBILI / AVAILABLE GLASS COLOURS



01 - Trasparente
Transparent



03 - Rosa
Pink



05 - Ambra
Amber



06 - Verde
Green



07 - Azzurro
Sky-Blue



08 - Fumè
Fume



16 - Tabacco
Tobacco



17 - Rubino
Ruby

COLORI VETRO METALLIZZATO DISPONIBILI / METALLIC GLASS COLOURS AVAILABLE



Bronzo
Bronze



Nero
Black



Verde ottanio
Teal green

NEW

FINITURA STRUTTURA/ CORPO METALLICO A VISTA DISPONIBILE / AVAILABLE METALLIC FINISHES FOR METAL-BODY-STRUCTURE



Cromo
Chrome



Black Carbon
Black Carbon



French gold
French gold

FINITURA DISPONIBILE PER: PIASTRE, BINARI E DISASSATORI / FINISH AVAILABLE FOR: PLATES, TRACKS AND SPACERS



Cromo
Chrome



Cromo spazzolato
Brushed chrome



Black Carbon
Black Carbon



French gold
French gold

CARATTERISTICHE TECNICHE / TECHNICAL FEATURES

MATERIALI: VETRO BOROSILICATO E OTTONE / MATERIALS: BOROSILICATE GLASS AND BRASS

CAVO ELETTRICO TRASPARENTE O TESSILE NERO / TRANSPARENT ELECTRIC CABLE OR BLACK TEXTILE

SORGENTE LUMINOSA / LIGHTING SOURCE:

- E14, E27 (IN BASE ALLA TIPOLOGIA / DEPENDING ON TYPE)
- LAMPADINA NON INCLUSA / BULB NOT INCLUDED

ON DEMAND / OPTIONAL FEATURES

- PERSONALIZZAZIONE LUNGHEZZA DEL CAVO SU RICHIESTA / CUSTOMISED CABLE LENGTH ON REQUEST
- A RICHIESTA CON COMPONENTI UL / ON DEMAND WITH UL COMPONENTS
- TIGE INTERNA A RICHIESTA BLACK CARBON E FRENCH GOLD (STANDARD CROMO) / INNER METAL TUBE, ON DEMAND BLACK CARBON OR FRENCH GOLD (STANDARD CHROME)

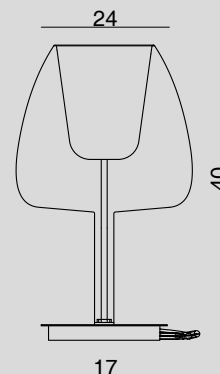
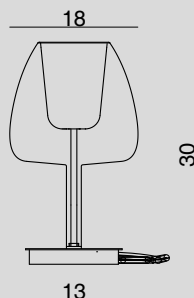
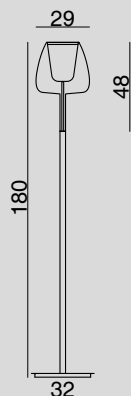

LU1685.1L

LAMPADA DA TERRA / FLOOR LAMP
 WITH DIMMER PUSH BUTTON

Glass 1 x Ø 29 cm - Cable 200 cm

1 x E27 105 W

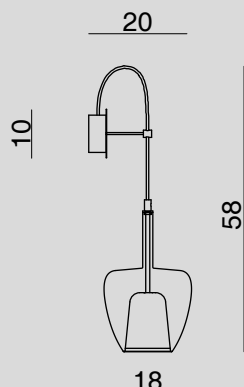
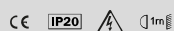

AP1681.1L

APPLIQUE / WALL LAMP

Glass 1 x Ø 18 cm - Cable 50 cm

1 x E14 60 W

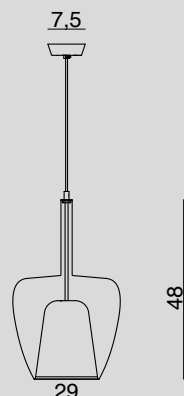
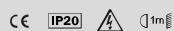

LU1680.1L

LAMPADA DA TAVOLO / TABLE LAMP
 WITH DIMMER PUSH BUTTON

Glass 1 x Ø 18 cm - Cable 200 cm

1 x E14 40 W

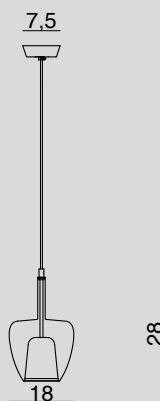
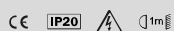

1683.1L

SOSPENSIONE A ROSONE / HANGING
 LAMP WITH CANOPY

Glass 1 x Ø 18 cm - Cable 150 cm

1 x E14 60 W

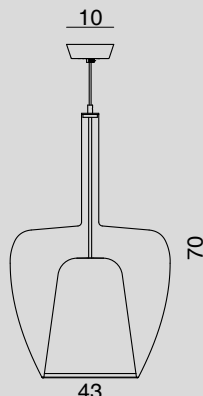
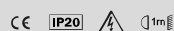

LUG1680.1L

LAMPADA DA TAVOLO / TABLE LAMP
 WITH DIMMER PUSH BUTTON

Glass 1 x Ø 24 cm - Cable 200 cm

1 x E27 60 W

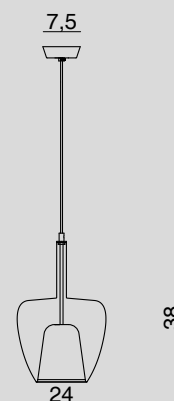
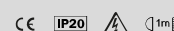

GIG1683.1L

SOSPENSIONE A ROSONE / HANGING LAMP
 WITH CANOPY

Glass 1 x Ø 24 cm - Cable 150 cm

1 x E27 105 W

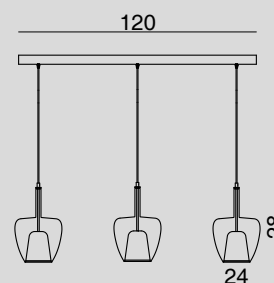
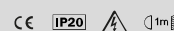

XXL1683.1L

SOSPENSIONE A ROSONE / HANGING
 LAMP WITH CANOPY

Glass 1 x Ø 29 cm - Cable 150 cm

1 x E27 105 W

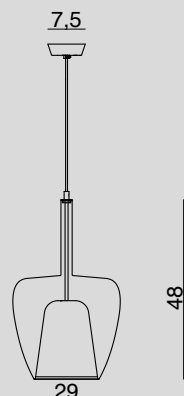
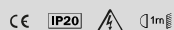

MAX1683.1L

SOSPENSIONE A ROSONE / HANGING
 LAMP WITH CANOPY

Glass 1 x Ø 43 cm - Cable 150 cm

1 x E27 105 W

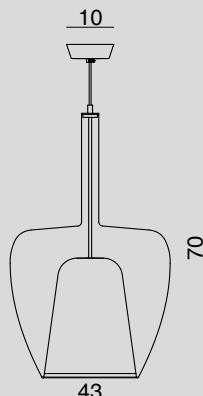
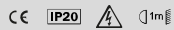

GIG1687.120.3L

SOSPENSIONE A BINARIO / HANGING
 LAMP WITH TRACKS

Glass 1 x Ø 24 cm - Cable 150 cm

3 x E27 105 W

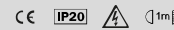

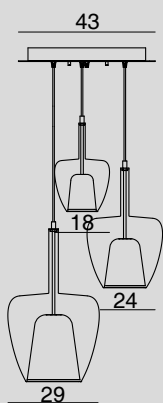

1689MX.43.3L

SOSPENSIONE A PIASTRA / HANGING LAMP
WITH CEILING PLATE

Glass 1 x Ø 18-24-29 cm - Cable 150 cm

1 x E14 60 W 2 x E27 105 W

CE IP20  1m

DETTAGLI PRODOTTO
PRODUCT DETAILS





LU1680.1L
LUGIG1680.1L
Glass: black
Structure: black carbon
with dimmer push button



3x 1693.1L

3x MED1693.1L

1x GIG1693.1L

Glass: bronze, satin white, black, teal green

Structure: satin gold (metal tube)

NEW

CHERRY[©]

DESIGN:  MARCANTONIO[®] (2020)





“SE QUESTA LUCE FOSSE UN FRUTTO, SAREBBE UNA CILIEGIA E COME OGNI CILIEGIA, CHERRY È UN INVITO. QUESTA È LA NUOVA IDEA LUMINOSA DI CANGINI E TUCCI FIRMATA DA MARCANTONIO NEL 2020. UN PICCOLO SOLE RACCHIUSO IN UNA BACCA DI VETRO LEGGERA COME UN SOFFIO. COME LA NATURA, SEMPLICE, PERFETTA E PIENA DI MISTERO, CHERRY ESPRIME IL FASCINO DI UN'ICONA. SOSPESA COME UN FRUTTO MATURO CHE ASPETTA SOLO DI ESSERE COLTO ILLUMINA LO SPAZIO CON LA SEMPLICITÀ DI UN GESTO NATURALE, LA TRASPARENZA SFUMATA DEL VETRO RICORDA LA SOTTILE PELLE DI UN FRUTTO, ED IL NUCLEO AL SUO INTERNO UN SEME PRONTO A GERMOGLIARE, PERCHÉ OGNI LUCE, COME OGNI FRUTTO, PORTA CON SÉ LA PROMESSA DI UNA NUOVA STORIA.” MARCANTONIO

“IF THIS LAMP WERE A FRUIT, IT WOULD BE A CHERRY, AND LIKE EVERY CHERRY, CHERRY IS AN INVITE.

THIS IS CANGINI E TUCCI'S NEW LIGHTING DESIGN BY MARCANTONIO IN 2020.

A SMALL SUN ENCLOSED IN A GLASS BERRY AS LIGHT AS A BREATH. LIKE NATURE, SIMPLE, PERFECT AND FULL OF MYSTERY, CHERRY EXPRESSES THE CHARM OF AN ICON. SUSPENDED LIKE A RIPE FRUIT JUST WAITING TO BE PLUCKED, IT ILLUMINATES SPACE WITH THE SIMPLICITY OF A NATURAL GESTURE, THE SHADED TRANSPARENCY OF THE GLASS REMINISCENT OF THE THIN SKIN OF A FRUIT, AND THE NUCLEUS WITHIN IT A SEED READY TO GERMINATE, BECAUSE EVERY LIGHT, LIKE EVERY FRUIT, CARRIES WITH IT THE PROMISE OF A NEW STORY.” MARCANTONIO



2x AP1691.1L
Glass: teal green
Structure: satin gold

LUMED1690.1L
Glass: teal green
Structure: satin gold



4x 1693.1L

3x MED1693.1L

1x GIG1693.1L

Glass: bronze, black, teal green
Structure: satin gold (metal tube)





2x MED1696.1L
2x GIG1696.1L
Glass: black
Structure: satin gold

3x AP1691.1L
Glass: teal green
Structure: satin gold



LUMED1690.1L

Glass: black

Structure: satin gold

2x 1693.1L

Glass: teal green, bronze

Structure: satin gold

**MED1697.120.3L**

Glass: black

Structure: satin back nichel

Track structure: matt black



Round Plate **P43.7L**
french gold finish

6x **MED1693**
1x **GIG1693**
Glass: bronze
Structure: satin gold (metal tube)



COLORI, MATERIALI, FINITURE / CMF

COLORI VETRO DISPONIBILI / AVAILABLE GLASS COLOURS



01 - Trasparente
Transparent



SW - Bianco satinato
Satin white



05 - Ambra sfumato
Amber nuanced



06 - Verde sfumato
Green nuanced



07 - Azzurro sfumato
Sky-blue nuanced



08 - Fumè sfumato
Fume nuanced



16 - Tabacco sfumato
Tobacco nuanced

COLORI VETRO METALLIZZATO DISPONIBILI / METALLIC GLASS COLOURS AVAILABLE



Bronzo sfumato
Bronze nuanced



Nero sfumato
Black nuanced

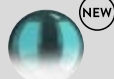

Verde ottanio sfumato
Teal green nuanced

NEW

FINITURA STRUTTURA/CORPO METALLICO A VISTA DISPONIBILE / AVAILABLE METALLIC FINISHES FOR METAL-BODY-STRUCTURE



Cromo
Chrome



Oro satinato
Satin gold



Nichel nero satinato
Satin black nickel

FINITURA DISPONIBILE PER: PIASTRE, BINARI E DISASSATORI / FINISH AVAILABLE FOR: PLATES, TRACKS AND SPACERS



Cromo
Chrome



Cromo spazzolato
Brushed chrome



Nero opaco
Matt black



Bianco opaco
Matt white

CARATTERISTICHE TECNICHE / TECHNICAL FEATURES

MATERIALI: VETRO BOROSILICATO, OTTONE E ALLUMINIO / MATERIALS: BOROSILICATE GLASS, BRASS AND ALUMINIUM

COMPATIBILE CON CASAMBI / COMPATIBLE WITH CASAMBI

DIMMERABILE A TAGLIO DI FASE / TRIAC DIMMABLE

LED (COB) E DRIVER INCLUSI / LED (COB) AND DRIVER INCLUDED

SCHEDA LED SOSTITUIBILE DA PROFESSIONISTA / LED BOARD REPLACEABLE BY PROFESSIONAL

I LUMEN INDICATI CORRISPONDONO ALL'INTENSITÀ LUMINOSA ALL'ORIGINE DELLA SCHEDA LED / LUMEN INDICATED CORRESPONDS TO THE LUMINOUS INTENSITY AT THE ORIGIN OF THE LED BOARD

DURATA DEL LED 50.000 ORE / LED LIFESPAN 50.000 HOURS

CAVO ELETTRICO COASSIALE A BASSA TENSIONE TRASPARENTE O NERO / COAXIAL LOW VOLTAGE ELECTRIC CABLE IN TRANSPARENT OR BLACK

SORGENTE LUMINOSA / LIGHTING SOURCE:

- LED 1x 6W - 11,2V-12,8V - 500mA - CRI Typ 95 - 866 Lm - 144 Lm/W - 180° - 3 Step MacAdam - 2700K or 3000K

ON DEMAND / OPTIONAL FEATURES

- PERSONALIZZAZIONE LUNGHEZZA DEL CAVO SU RICHIESTA / CUSTOMISED CABLE LENGTH ON REQUEST
- A RICHIESTA CON COMPONENTI UL / ON DEMAND WITH UL COMPONENTS
- DISPONIBILE SU RICHIESTA CON DRIVER DALI / AVAILABLE ON REQUEST WITH DALI DRIVER

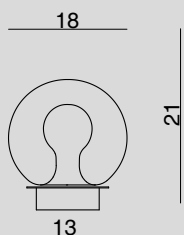

LU1690.1L

LAMPADA DA TAVOLO / TABLE LAMP WITH DIMMER PUSH BUTTON

Glass 1 x Ø 18 cm - Cable 200 cm

1 x LED 6 W DIMM

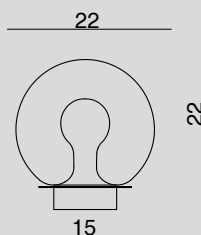
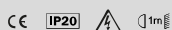

LUMED1690.1L

LAMPADA DA TAVOLO / TABLE LAMP WITH DIMMER PUSH BUTTON

Glass 1 x Ø 22 cm - Cable 200 cm

1 x LED 6 W DIMM

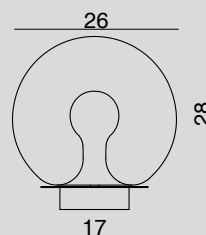
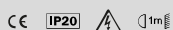

LUGIG1690.1L

LAMPADA DA TAVOLO / TABLE LAMP WITH DIMMER PUSH BUTTON

Glass 1 x Ø 26 cm - Cable 200 cm

1 x LED 6 W DIMM

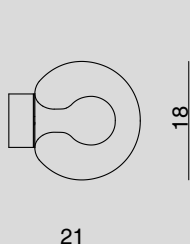
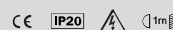

AP1691.1L

APPLIQUE / WALL LAMP

Glass 1 x Ø 18 cm

1 x LED 6 W DIMM

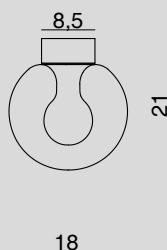
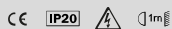

1696.1L

PLAFONIERA / CEILING LAMP

Glass 1 x Ø 18 cm

1 x LED 6 W DIMM

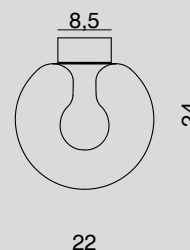
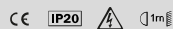

MED1696.1L

PLAFONIERA / CEILING LAMP

Glass 1 x Ø 22 cm

1 x LED 6 W DIMM

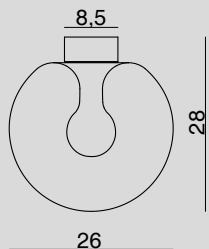
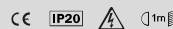

GIG1696.1L

PLAFONIERA / CEILING LAMP

Glass 1 x Ø 26 cm

1 x LED 6 W DIMM

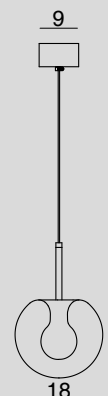
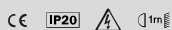

1693.1L

SOSPENSIONE A ROSONE / HANGING LAMP WITH CANOPY

Glass 1 x Ø 18 cm - Cable 200 cm

1 x LED 6 W DIMM

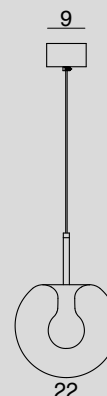
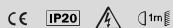

MED1693.1L

SOSPENSIONE A ROSONE / HANGING LAMP WITH CANOPY

Glass 1 x Ø 22 cm - Cable 200 cm

1 x LED 6 W DIMM



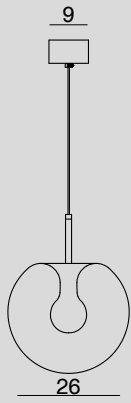

GIG1693.1L

SOSPENSIONE A ROSONE / HANGING LAMP WITH CANOPY

Glass 1 x Ø 26 cm - Cable 200 cm

1 x LED 6 W DIMM

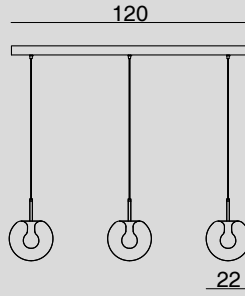
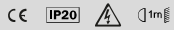

MED1697.120.3L

SOSPENSIONE A BINARIO / HANGING LAMP WITH TRACKS

Glass 3 x Ø 22 cm - Cable 200 cm

3 x LED 6 W DIMM

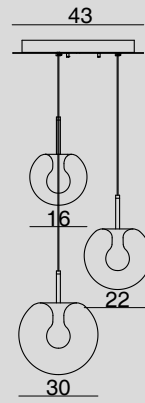
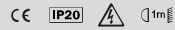

1699MX.43.3L

SOSPENSIONE A PIASTRA / HANGING LAMP WITH CEILING PLATE

Glass 3 x Ø 18-22-26 cm - Cable 200 cm

3 x LED 6 W DIMM

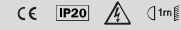



LUMED1690.1L
Glass: bronze
Structure: satin gold

2x MED1696.1L
Glass: bronze
Structure: satin gold

WINNER

DESIGN **PLUS**

powered by: **light+building**

Best of award 2022





FREQUENCY^{©©}

DESIGN:  MARCANTONIO[®] (2022)



FREQUENCY È UNA LAMPADA LINEARE A LED REALIZZATA IN VETRO SOFFIATO E DISEGNATA DA MARCANTONIO. FREQUENCY ESISTE IN DUE VERSIONI, ENTRAMBE A SOSPENSIONE. LA PRIMA PUÒ ESSERE INSTALLATA IN ORIZZONTALE, SOPRA UN TAVOLO DA PRANZO, SOPRA UN BANCO RECEPTION O UNA SCRIVANIA IN UFFICIO. LA SECONDA VIENE INSTALLATA IN VERTICALE E FUNZIONA COME UNA PIANTANA, MA SENZA ALCUN INGOMBRO A TERRA, DAL MOMENTO CHE NON HA UNA BASE. FREQUENCY, COME TUTTE LE LAMPADE DI CANGINI E TUCCI È STATA INTERAMENTE REALIZZATA A MANO IN ITALIA.

“FREQUENCY NASCE DALLA VOLONTÀ DI ESALTARE L'ESSENZA DELLA LUCE, HO IMMAGINATO UN FASCIO LUMINOSO CHE VIAGGIVA NELLO SPAZIO. VOLEVO CHE LA FORMA DEL VETRO RACCONTASSE IL MOVIMENTO E L'INTENSITÀ DELL'ENERGIA SPRIGIONATA DA QUESTO RAGGIO. ATTRAVERSO UN SAPIENTE CONTROLLO DEL VETRO, GRAZIE ALL'ESPERIENZA DI CANGINI E TUCCI, SIAMO RIUSCITI A CREARE UN OGGETTO SCULTOREO DAL CARATTERE DEFINITO MA AL CONTEMPO FLUIDO E LEGGERO, UN OGGETTO IN CUI LE FORME SEMBRANO COMPENETRARSI, IN CUI I VOLUMI SCIVOLANO GLI UNI DENTRO AGLI ALTRI COME IN UN'ONDA DI ENERGIA VIVA E ATTIVA. FREQUENCY È UNA LAMPADA CONTEMPORANEA CHE CELEBRA L'ARTE DEL VETRO LAVORATO A MANO COME SOLO UNA SCULTURA PUÒ FARE”. MARCANTONIO

FREQUENCY IS A LINEAR LED LAMP MADE OF BLOWN GLASS AND DESIGNED BY MARCANTONIO. FREQUENCY EXISTS IN TWO VERSIONS, BOTH HANGING. THE FIRST CAN BE INSTALLED HORIZONTALLY, OVER A DINING TABLE, ABOVE A RECEPTION DESK OR A DESK IN AN OFFICE. THE SECOND IS INSTALLED VERTICALLY AND WORKS LIKE A FLOOR LAMP, BUT WITHOUT ANY OBSTACLE ON THE GROUND, SINCE IT DOES NOT HAVE A BASE. FREQUENCY, LIKE ALL CANGINI AND TUCCI LAMPS, IS ENTIRELY HANDMADE IN ITALY.

“FREQUENCY WAS BORN FROM THE DESIRE TO ENHANCE THE ESSENCE OF LIGHT. I IMAGINED A BEAM OF LIGHT THAT TRAVELED THROUGH SPACE. I WANTED THE SHAPE OF THE GLASS TO TELL THE MOVEMENT AND INTENSITY OF THE ENERGY RELEASED BY THIS BEAM. THROUGH A SKILFUL CONTROL OF THE GLASS, THANKS TO THE EXPERIENCE OF CANGINI AND TUCCI, WE MANAGED TO CREATE A SCULPTURAL OBJECT WITH A DEFINITE CHARACTER BUT AT THE SAME TIME FLUID AND LIGHT, AN OBJECT IN WHICH THE SHAPES SEEM TO INTERPENETRATE, IN WHICH THE VOLUMES SLIDE INTO EACH OTHER AS IN A WAVE OF LIVING AND ACTIVE ENERGY. FREQUENCY IS A CONTEMPORARY LAMP THAT CELEBRATES THE ART OF HANDMADE GLASS AS ONLY A SCULPTURE CAN DO”. MARCANTONIO





1x **1553.OR.2**
Glass: transparent
Structure: satin gold

1x **GIG1553.OR.2**
Glass: transparent
Structure: satin gold





**MINI1553.VE**

Glass: transparent

Structure: satin black nickel



AP1551
Glass: transparent
Structure: satin gold



GIG1553.OR.2
Glass: transparent
Structure: satin gold

1555.VE
Glass: bicoloured shiny-tobacco
Structure: satin gold





COLORI, MATERIALI, FINITURE / CMF

COLORI VETRO DISPONIBILI / AVAILABLE GLASS COLOURS



01 - Trasparente
Transparent



IT - Iride+Tabacco
Shiny+Tobacco

FINITURA STRUTTURA/CORPO METALLICO A VISTA DISPONIBILE / AVAILABLE METALLIC FINISHES FOR METAL-BODY-STRUCTURE



Cromo
Chrome



Oro satinato
Satin gold



Nichel nero satinato
Satin black nickel

CARATTERISTICHE TECNICHE / TECHNICAL FEATURES

MATERIALI: VETRO BOROSILICATO E OTTONE / MATERIALS: BOROSILICATE GLASS AND BRASS

LED (COB) E DRIVER INCLUSI / LED (COB) AND DRIVER INCLUDED

SCHEDA LED SOSTITUIBILE DA PROFESSIONISTA / LED BOARD REPLACEABLE BY PROFESSIONAL

DURATA DEL LED 50.000 ORE / LED LIFESPAN 50.000 HOURS

LED SOSTITUIBILE DA AZIENDA PRODUTTRICE / LED REPLACEABLE BY MANUFACTURER

CAVO ELETTRICO COASSIALE A BASSA TENSIONE TRASPARENTE / COAXIAL LOW VOLTAGE ELECTRIC CABLE IN TRANSPARENT

*** SOSPENSIONI DIMMERABILI CON DISPOSITIVO AGGIUNTIVO (NON FORNITO) / DIMMABLE WITH ADDITIONAL DEVICE (NOT INCLUDED)**

SOSPENSIONE 1555.VE CON DIMMER GIÀ INCLUSO / 1555.VE HANGING LAMP WITH DIMMER INCLUDED



SORGENTE LUMINOSA / LIGHTING SOURCE:

LED DISPONIBILE PER LA LINEA FREQUENCY[®] SOSPENSIONE L128 cm / LED AVAILABLE FOR FREQUENCY[®] SUSPENSION L128 cm:

• **LED 21,6 W DIMM - 3245 Lm - 150,2 Lm/W - 1080 mA - CRI Typ 95 - 20V - 2700°K or 3000°K** (1 LUMEN INDICATI CORRISPONDONO ALL'INTENSITÀ LUMINOSA ALL'ORIGINE DELLA BACCHETTA LED / LUMEN INDICATED CORRESPONDS TO THE LUMINOUS INTENSITY AT THE ORIGIN OF THE LED LIGHT BAR)

LUMEN ALL'INTENSITÀ LUMINOSA CON VETRO TRASPARENTE / LUMEN LUMINOUS INTENSITY WITH TRANSPARENT GLASS: Lm 1350

LED DISPONIBILE PER LA LINEA FREQUENCY[®] SOSPENSIONE L150 cm / LED AVAILABLE FOR FREQUENCY[®] SUSPENSION L150 cm:

• **LED 24,48 W DIMM - 3677 Lm - 150,2 Lm/W - 1080 mA - CRI Typ 95 - 20V - 2700°K or 3000°K** (1 LUMEN INDICATI CORRISPONDONO ALL'INTENSITÀ LUMINOSA ALL'ORIGINE DELLA BACCHETTA LED / LUMEN INDICATED CORRESPONDS TO THE LUMINOUS INTENSITY AT THE ORIGIN OF THE LED LIGHT BAR)

LUMEN ALL'INTENSITÀ LUMINOSA CON VETRO TRASPARENTE / LUMEN LUMINOUS INTENSITY WITH TRANSPARENT GLASS: Lm 2400-2600

LED DISPONIBILE PER LA LINEA FREQUENCY[®] L63 cm / LED AVAILABLE FOR FREQUENCY[®] L63 cm:

• **LED 10,8 W DIMM - 1622 Lm - 150,2 Lm/W - 540 mA - CRI Typ 95 - 20V - 2700°K or 3000°K** (1 LUMEN INDICATI CORRISPONDONO ALL'INTENSITÀ LUMINOSA ALL'ORIGINE DELLA BACCHETTA LED / LUMEN INDICATED CORRESPONDS TO THE LUMINOUS INTENSITY AT THE ORIGIN OF THE LED LIGHT BAR)

LUMEN ALL'INTENSITÀ LUMINOSA CON VETRO TRASPARENTE / LUMEN LUMINOUS INTENSITY WITH TRANSPARENT GLASS: Lm 675

ON DEMAND / OPTIONAL FEATURES

- **PERSONALIZZAZIONE LUNGHEZZA DEL CAVO SU RICHIESTA / CUSTOMISED CABLE LENGTH ON REQUEST**
- **A RICHIESTA CON COMPONENTI UL / ON DEMAND WITH UL COMPONENTS**

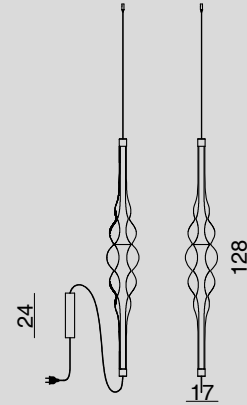
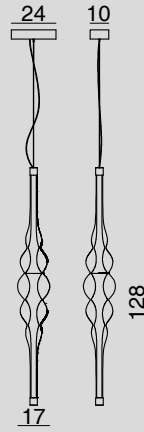
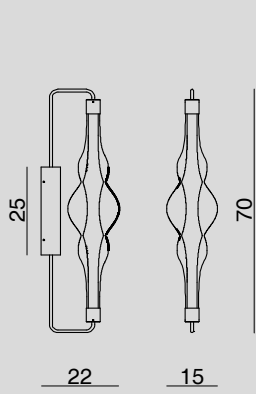

AP1551

APPLIQUE / WALL LAMP

Glass 1 x Ø 15 cm

1 x LED 10,8W DIMM

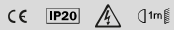

1553.VE

SOSPENSIONE A ROSONE / HANGING LAMP WITH CANOPY

Glass 1 x Ø 17 cm - Cable 200 cm

1 x LED 21,6 W DIMM

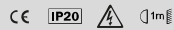

1555.VE

SOSPENSIONE CON SPINA E DIMMER / HANGING LAMP WITH PLUG AND DIMMER PUSH BUTTON

Glass 1 x Ø 17 cm - Cable 200 cm

1 x LED 21,6 W DIMM

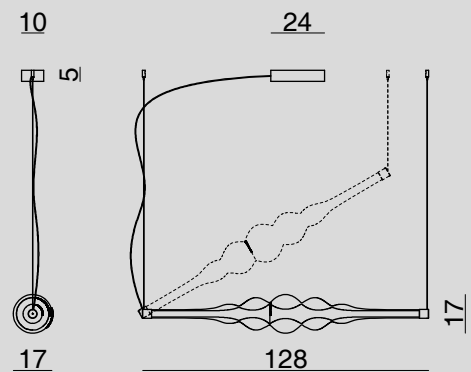
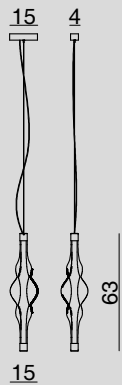
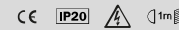

MINI1553.VE

SOSPENSIONE A ROSONE / HANGING LAMP WITH CANOPY

Glass 1 x Ø 15 cm - Cable 200 cm

1 x LED 10,8W DIMM

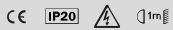

1553.OR.2

SOSPENSIONE A ROSONE / HANGING LAMP WITH CANOPY

Glass 1 x Ø 17 cm - Cable 200 cm

1 x LED 21,6 W DIMM

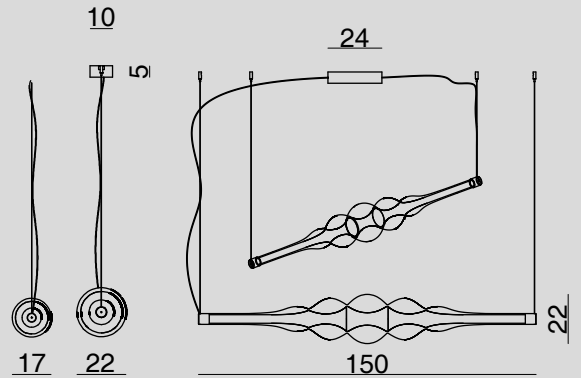
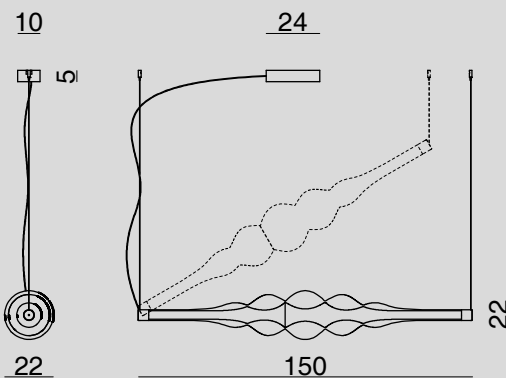
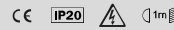

GIG1553.OR.2

SOSPENSIONE A ROSONE / HANGING LAMP WITH CANOPY

Glass 1 x Ø 22 cm - Cable 200 cm

1 x LED 24 W DIMM

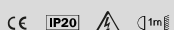

1553MX.2L

SOSPENSIONE A ROSONE / HANGING LAMP WITH CANOPY

Glass 1 x Ø 17-22 cm - Cable 200 cm

1 x LED 21,6 W DIMM - 1 x LED 24 W DIMM





1583
GIG1583
XXL1583
MAX1583

*Glass: transparent, fume (08), tobacco (16)
Structure: satin rose gold*

LU1585.1L
*Glass: transparent
Structure: satin rose gold*

PIT^{©©}

DESIGN: PIETRO TUCCI (2021)



NEW

PIT OVERSIZE

PIT OVERSIZE È L'ULTIMA ARRIVATA DELLA FAMIGLIA PIT. CON UN DIAMETRO IMPORTANTE DI 45 CM QUESTA LAMPADA È PENSATA PER DIVENTARE IL CUORE PULSANTE DEL TUO AMBIENTE. LA FORMA ROTONDA E ARMONIOSA DIFFONDE LA LUCE IN MODO DELICATO E UNIFORME, CREANDO UN'ATMOSFERA ACCOGLIENTE E RAFFINATA.

PIT OVERSIZE IS THE LATEST ENTRY IN THE PIT FAMILY. WITH AN IMPORTANT DIAMETER OF Ø45 CM, THIS LAMP IS DESIGNED TO BECOME THE BEATING HEART OF YOUR AMBIENCE. THE ROUND, HARMONIOUS SHAPE DIFFUSES THE LIGHT GENTLY AND EVENLY, CREATING A COSY AND REFINED ATMOSPHERE.

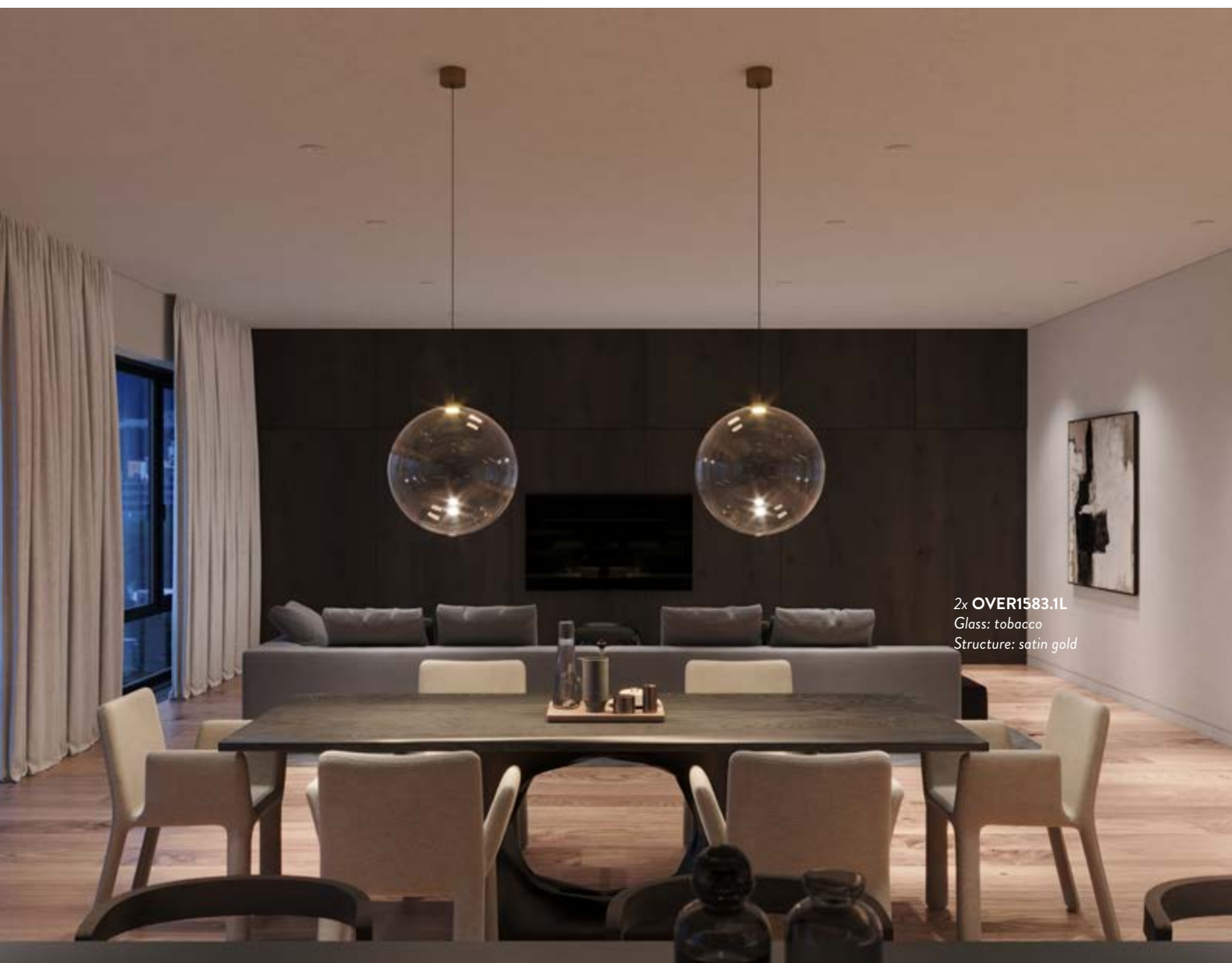

2x **OVER1583.1L**
Glass: tobacco
Structure: satin gold



OVER1583.1L
Glass: transparent



1583
GIG1583
XXL1583
Glass: transparent, amber (05), fume (08)



6x 1583

3x GIG1583

3x XXL1583

1x MAX1583

Glass: transparent

Structure: custom white plate Ø100 cm



Track **AUF150**

3x **MAX1583**
Glass: amber (05)

Plate P50

1x 1583

Glass: tobacco (16)

1x GIG1583

Glass: tobacco (16)

1x XXL1583

Glass: transparent

2x MAX1583

Glass: amber (05), fume (08)





LU1585.1L

Glass: fume (08)

Structure: satin black nickel

Dior



1583.1L
Glass: fume (08)



LU1580.1L

Glass: fume (08)

Structure: satin black nickel



Track **AUF150.5L**
matt black finish

5x **1583**
Glass: transparent, amber (05), fume (08)



COLORI, MATERIALI, FINITURE / CMF

COLORI VETRO DISPONIBILI / AVAILABLE GLASS COLOURS



01 - Trasparente
Transparent



03 - Rosa
Pink



05 - Ambra
Amber



06 - Verde
Green



07 - Azzurro
Sky-Blue



08 - Fumè
Fume



16 - Tabacco
Tobacco



17 - Rubino
Ruby

FINITURA STRUTTURA/CORPO METALLICO A VISTA DISPONIBILE / AVAILABLE METALLIC FINISHES FOR METAL-BODY-STRUCTURE



Cromo
Chrome



Cromo spazzolato
Brushed chrome



Oro satinato
Satin gold
(on request)



Nichel nero satinato
Satin black nickel
(on request)



Nero opaco
Matt black



Oro rosa satinato
Satin rose gold
(on request)



Bianco opaco
Matt white

FINITURA DISPONIBILE PER: PIASTRE, BINARI E DISASSATORI / FINISH AVAILABLE FOR: PLATES, TRACKS AND SPACERS



Cromo
Chrome



Cromo spazzolato
Brushed chrome



Nero opaco
Matt black



Bianco opaco
Matt white

FINITURA DISPONIBILE PER: LAMPADA DA TAVOLO E LAMPADA DA TERRA / FINISH AVAILABLE FOR: TABLE LAMP AND FLOOR LAMP



Nichel nero satinato
Satin black nickel



Oro satinato
Satin gold



Oro rosa satinato
Satin rose gold

CARATTERISTICHE TECNICHE / TECHNICAL FEATURES

MATERIALI: VETRO BOROSILICATO E ALLUMINIO / MATERIALS: BOROSILICATE GLASS AND ALUMINIUM

COMPATIBILE CON CASAMBI / COMPATIBLE WITH CASAMBI

DIMMERABILE A TAGLIO DI FASE / TRIAC DIMMABLE

LED (COB) E DRIVER INCLUSI / LED (COB) AND DRIVER INCLUDED

SCHEDA LED SOSTITUIBILE DA PROFESSIONISTA / LED BOARD REPLACEABLE BY PROFESSIONAL

I LUMEN INDICATI CORRISPONDONO ALL'INTENSITÀ LUMINOSA ALL'ORIGINE DELLA SCHEDA LED / LUMEN INDICATED CORRESPONDS TO THE LUMINOUS INTENSITY AT THE ORIGIN OF THE LED BOARD

DURATA DEL LED 50.000 ORE / LED LIFESPAN 50.000 HOURS

CAVO ELETTRICO COASSIALE A BASSA TENSIONE TRASPARENTE O NERO / COAXIAL LOW VOLTAGE ELECTRIC CABLE IN TRANSPARENT OR BLACK

SORGENTE LUMINOSA / LIGHTING SOURCE:

LED DISPONIBILE PER LAMPADA DA TAVOLO E SOSPENSIONI / LEDS AVAILABLE FOR TABLE LAMP AND HANGING LAMP

• LED 1x 6W - 11,2V-12,8V - 500mA - CRI Typ 95 - 866 Lm - 144 Lm/W - 180° - 3 Step MacAdam - 2700K or 3000K

LED DISPONIBILE PER LAMPADA DA TERRA E SOSPENSIONE OVER1583 / LEDS AVAILABLE FOR FLOOR LAMP AND HANGING LAMP OVER1583

• LED 1x 12W - 22,4V-24,8V - 500mA - CRI Typ 95 - 1.717 Lm - 144 Lm/W - 180° - 3 Step MacAdam - 2700K or 3000K

LED DISPONIBILE PER LAMPADA A SOSPENSIONE MAX1583 / LEDS AVAILABLE FOR HANGING LAMP MAX1583

• LED 1x 8,4W - 22,4V-24,8V - 350mA - CRI Typ 95 - 1.202 Lm - 144 Lm/W - 180° - 3 Step MacAdam - 2700K or 3000K

ON DEMAND / OPTIONAL FEATURES

- PERSONALIZZAZIONE LUNGHEZZA DEL CAVO SU RICHIESTA / CUSTOMISED CABLE LENGTH ON REQUEST
- A RICHIESTA CON COMPONENTI UL / ON DEMAND WITH UL COMPONENTS
- DISPONIBILE SU RICHIESTA CON DRIVER DALI / AVAILABLE ON REQUEST WITH DALI DRIVER
- A RICHIESTA: ARTICOLI GIG1583 E XXL1583 CON LED DA 8,4W (1202 Lm) / ON DEMAND: PRODUCTS GIG1583 AND XXL1583 WITH 8,4W LED (1202 Lm)
- PIT XXL1583 E MAX1583 DISPONIBILE CON SISTEMA UP E DOWN / PIT XXL1583 AND MAX1583 AVAILABLE WITH UP AND DOWN SYSTEM



LU1585.1L

LAMPADA DA TERRA / FLOOR LAMP

Glass 1 x Ø 30 cm - Cable 200 cm

1 x LED 12 W DIMM

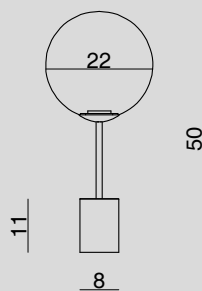
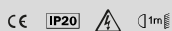

LU1580.1L

LAMPADA DA TAVOLO / TABLE LAMP

Glass 1 x Ø 22 cm - Cable 200 cm

1 x LED 6 W DIMM

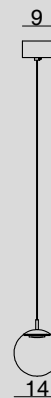
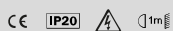

S1583.14.1L

SOSPENSIONE A ROSONE / HANGING LAMP WITH CANOPY

Glass 1 x Ø 14 cm - Cable 200 cm

1 x LED 6 W DIMM

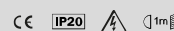

S1583.16.1L

SOSPENSIONE A ROSONE / HANGING LAMP WITH CANOPY

Glass 1 x Ø 16 cm - Cable 200 cm

1 x LED 6 W DIMM

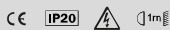

S1583.18.1L

SOSPENSIONE A ROSONE / HANGING LAMP WITH CANOPY

Glass 1 x Ø 18 cm - Cable 200 cm

1 x LED 6 W DIMM

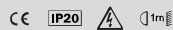

1583.1L

SOSPENSIONE A ROSONE / HANGING LAMP WITH CANOPY

Glass 1 x Ø 22 cm - Cable 200 cm

1 x LED 6 W DIMM

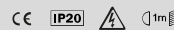

GIG1583.1L

SOSPENSIONE A ROSONE / HANGING LAMP WITH CANOPY

Glass 1 x Ø 26 cm - Cable 200 cm

1 x LED 6 W DIMM

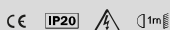

XXL1583.1L

SOSPENSIONE A ROSONE / HANGING LAMP WITH CANOPY

Glass 1 x Ø 30 cm - Cable 200 cm

1 x LED 6 W DIMM

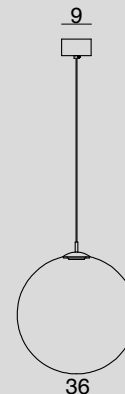
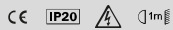

MAX1583.1L

SOSPENSIONE A ROSONE / HANGING LAMP WITH CANOPY

Glass 1 x Ø 36 cm - Cable 200 cm

1 x LED 8,4 W DIMM

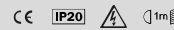

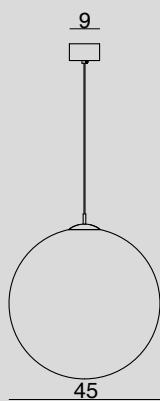

OVER1583.1L

SOSPENSIONE A ROSONE / HANGING LAMP WITH CANOPY

Glass 1 x Ø 45 cm - Cable 200 cm

1 x LED 12 W DIMM

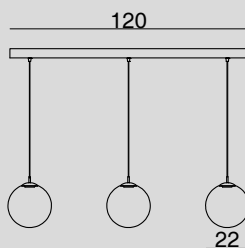
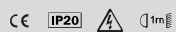

1587.120.3L

SOSPENSIONE A BINARIO / HANGING LAMP WITH TRACKS

Glass 3 x Ø 22 cm - Cable 200 cm

3 x LED 6 W DIMM

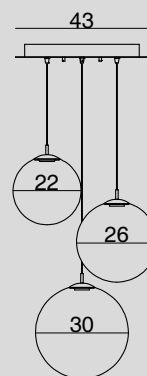
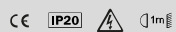

1589MX.43.3L

SOSPENSIONE A PIASTRA / HANGING LAMP WITH CEILING PLATE

Glass 3 x Ø 22-26-30 cm - Cable 200 cm

3 x LED 6 W DIMM

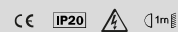

DETTAGLI PRODOTTO
PRODUCT DETAILS





PIT SPECIAL FIXTURE
Glass: coloured mix

PHOTOS: MAURO PINI

PROJECT: HOTEL VILLA CORTINE
SIRMIONE (BS)

ARCHITETTO CERESOLI CARLO
IN COLLABORAZIONE
CON OFFICINA LUCE



BA1538.S

Glass: transparent

Structure: satin black nickel

NEW

AERON FREE[©]

DESIGN: PIETRO TUCCI (2025)



DALLA NOSTRA ICONICA COLLEZIONE AERON, NASCE IL NUOVO ESCLUSIVO MODELLO DI LAMPADA A BATTERIA AERON FREE. UN'EVOLOZIONE CHE MANTIENE L'ELEGANZA E L'INNOVAZIONE CHE CONTRADDISTINGUONO LA LINEA, INTRODUCENDO NUOVE CARATTERISTICHE PENSATE PER RISPONDERE A ULTERIORI ESIGENZE DI STILE E FUNZIONALITÀ. GRAZIE ALL'ASSENZA DI CAVI E ALLA BATTERIA RICARICABILE INTEGRATA, LA LAMPADA OFFRE MASSIMA LIBERTÀ DI POSIZIONAMENTO, ADATTANDOSI PERFETTAMENTE A DIVERSE ESIGENZE E CONTESTI. LA SORGENTE LUMINOSA A LED GARANTISCE UN'ILLUMINAZIONE EFFICIENTE E MODULABILE GESTITA DA TASTO DIMMER A PRESSIONE, CREANDO ATMOSFERE ACCOGLIENTI E PERSONALIZZATE.

FROM OUR ICONIC AERON COLLECTION COMES THE NEW EXCLUSIVE AERON FREE BATTERY-OPERATED LAMP MODEL. AN EVOLUTION THAT KEEPS THE ELEGANCE AND INNOVATION THAT DISTINGUISH THE LINE, WHILE INTRODUCING NEW FEATURES DESIGNED TO MEET ADDITIONAL DEMANDS IN TERMS OF STYLE AND FUNCTIONALITY. THANKS TO THE ABSENCE OF CABLES AND THE INTEGRATED RECHARGEABLE BATTERY, THE LAMP OFFERS MAXIMUM FREEDOM OF POSITIONING, ADAPTING PERFECTLY TO DIFFERENT NEEDS AND CONTEXTS. THE LED LIGHT SOURCE GUARANTEES EFFICIENT AND MODULAR LIGHTING MANAGED BY DIMMER PUSH BUTTON, CREATING COSY AND PERSONALISED ATMOSPHERES.

BA1538.S

Glass: transparent
Structure: satin gold



AERON FREE[©]

DETTAGLI PRODOTTO
PRODUCT DETAILS



COLORI, MATERIALI, FINITURE / CMF

COLORI VETRO DISPONIBILI / AVAILABLE GLASS COLOURS



01 - Trasparente
Transparent



05 - Ambra sfumato
Amber nuanced



Verde sfumato
Green nuanced



Azzurro sfumato
Sky-blue nuanced



Fumè sfumato
Fume nuanced



Tabacco sfumato
Tobacco nuanced

FINITURA STRUTTURA/CORPO METALLICO A VISTA DISPONIBILE / AVAILABLE METALLIC FINISHES FOR METAL-BODY-STRUCTURE



Cromo
Chrome



Oro satinato
Satin gold



Nichel nero satinato
Satin black nickel

CARATTERISTICHE TECNICHE / TECHNICAL FEATURES

MATERIALI: VETRO BOROSILICATO E ALLUMINIO / MATERIALS: BOROSILICATE GLASS AND ALUMINIUM

CONTROLLO TOUCH PER REGOLARE L'INTENSITÀ LUMINOSA / TOUCH CONTROL FOR LIGHT INTENSITY REGULATION

AUTONOMIA 6 ORE CON LAMPADA ACCESA AL 100% / AUTONOMY 6 HOURS WITH 100 % LAMP ON

TEMPO DI RICARICA: CIRCA 5 ORE (A LAMPADA SPENTA) / CHARGING TIME: APPROX. 5 HOURS (WITH LAMP SWITCHED OFF)

CAVO DI RICARICA USB-C INCLUSO / USB-C CHARGING CABLE INCLUDED

ALIMENTATORE NON INCLUSO / POWER UNIT NOT INCLUDED

BATTERIA SOSTITUIBILE / REPLACEABLE BATTERY

LED (COB) E DRIVER INCLUSI / LED (COB) AND DRIVER INCLUDED

SCHEDA LED SOSTITUIBILE DA PROFESSIONISTA / LED BOARD REPLACEABLE BY PROFESSIONAL

SORGENTE LUMINOSA / LIGHTING SOURCE:

• LED 1x 2,9W - 8,3V-8,4V - 350mA - CRI >80 - 516 Lm - 178 Lm/W - 3 Step MacAdam - 2700K or 3000K

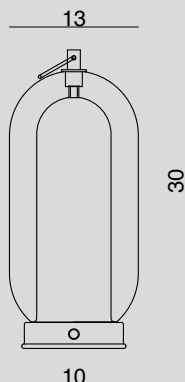

BA1538.S

LAMPADA DA TAVOLO / TABLE LAMP

Glass 1 x Ø 13 cm

1 x LED 2,9 W DIMM



BA1538.S
Glass: fume (08)
Structure: satin gold



3x **XXL1533.1L**
Glass: *transparent*
Structure: *satin gold*



AERON[©]

DESIGN: PIETRO TUCCI (2022)

AERON È UNA FAMIGLIA DI LAMPADE, A SOSPENSIONE E DA TAVOLO. LA SCOCCA, INTERAMENTE REALIZZATA IN VETRO SOFFIATO A MANO, È CARATTERIZZATA DA UN VETRO A DOPPIA CAMERA. LA CAMERA INTERNA È SATINATA PER DIFFONDERE IN MODO PIÙ ARMONICO E NATURALE LA LUCE E PER RIDURRE L'ABBAGLIAMENTO, LA SUPERFICIE ESTERNA INVECE È TRASPARENTE E PUÒ ESSERE REALIZZATA IN DIVERSI COLORI. LE MONTATURE METALLICHE SONO DISPONIBILI IN CROMO, ORO SATINATO E NICHEL NERO SATINATO.

LA LAMPADA A SOSPENSIONE È REALIZZATA IN 4 VARIANTI DIMENSIONALI, DA 13 FINO A 28 CM DI DIAMETRO CON UN'ALTEZZA COMPRESA TRA I 28 E I 55 CM.

LA VERSIONE DA TAVOLO È REALIZZATA INVECE IN 3 DIMENSIONI DIVERSE: 13, 21 E 28CM DI DIAMETRO CON UN'ALTEZZA DI 29, 49, E 56 CM. SULLA PARTE SUPERIORE TROVIAMO UN COMODO ANELLO DI METALLO, CHE SERVE PER TRASPORTARE LA LAMPADA, QUASI COME FOSSE UNA LANTERNA.

LA LAMPADA È LEGGERISSIMA, LA CUPOLA IN VETRO SEMBRA CUSTODIRE LA LUCE PER PROTEGGERLA E LASCIARLA BRILLARE IN ETERNO, COME UNA TECA. LA LUCE VIENE DIFFUSA IN MODO MOLTO OMOGENEO LUNGO LA GENEROSA SUPERFICIE INTERNA DELLA LAMPADA E QUESTO GARANTISCE UNA QUALITÀ DI LUCE MOLTO ELEVATA. LA PULIZIA DELLE LINEE CONSENTE UNA GRANDE VERSATILITÀ DI INSTALLAZIONE, SIA PER AMBIENTI HOME CHE PER HOTEL, RISTORANTI E RETAIL.

AERON IS A COLLECTION OF TABLE AND SUSPENSION LAMPS. THE BODY IS CHARACTERIZED BY A DOUBLE-CHAMBER GLASS AND IS ENTIRELY MADE OF HAND-BLOWN GLASS. THE INNER CHAMBER IS SATIN-FINISHED TO DIFFUSE THE LIGHT IN A MORE HARMONIOUS AND NATURAL WAY AND TO REDUCE GLARE, WHILE THE OUTER SURFACE IS TRANSPARENT AND CAN BE MADE IN DIFFERENT COLORS. THE METAL STRUCTURE IS AVAILABLE IN CHROME, SATIN GOLD AND SATIN BLACK NICKEL FINISH.

THE PENDANT LAMP IS MADE IN 4 SIZE VARIANTS, STARTING FROM 13 UP TO 28 CM IN DIAMETER WITH A HEIGHT BETWEEN 28 AND 55 CM.

THE TABLE VERSION IS INSTEAD MADE IN 3 DIFFERENT SIZES: 13, 21 AND 28 CM DIAMETER WITH A HEIGHT OF 29, 49, AND 56 CM. ON THE TOP WE FIND A CONVENIENT METAL RING USEFUL TO CARRY THE LAMP LIKE A LANTERN.

THE LAMP IS VERY LIGHT, THE GLASS DOME SEEMS TO PROTECT THE LIGHT AND LET IT SHINE FOREVER, LIKE A SHRINE. THE LIGHT IS DIFFUSED IN A VERY HOMOGENEOUS WAY ALONG THE BIG SATIN SURFACE OF THE LAMP AND THIS GUARANTEES A VERY HIGH QUALITY OF LIGHT. THE CLEAN LINES ALLOW GREAT VERSATILITY OF INSTALLATION BOTH FOR HOME ENVIRONMENTS AND FOR HOTELS, RESTAURANTS AND RETAIL.



LU1530
Glass: transparent
Structure: satin black nickel

**LUGIG1530**

Glass: amber (05)

Structure: satin black nickel

LU1530
LUGIG1530
LUXXL1530

Glass: transparent

Structure: satin black nickel





1533.1L
MED1533.1L
GIG1533.1L
*Glass: transparent
Structure: satin gold*



1533.1L
MED1533.1L
GIG1533.1L

Glass: amber (05), sky-blue (07), green (06), ruby (17), fume (08)
Structure: satin black nickel





COLORI, MATERIALI, FINITURE / CMF

COLORI VETRO DISPONIBILI / AVAILABLE GLASS COLOURS



01 - Trasparente
Transparent



03 - Rosa
Pink



05 - Ambra
Amber



06 - Verde
Green



07 - Azzurro
Sky-Blue



08 - Fumè
Fume



16 - Tabacco
Tobacco



17 - Rubino
Ruby

FINITURA STRUTTURA/CORPO METALLICO A VISTA DISPONIBILE / AVAILABLE METALLIC FINISHES FOR METAL-BODY-STRUCTURE



Cromo
Chrome



Oro satinato
Satin gold



Nichel nero satinato
Satin black nickel

FINITURA DISPONIBILE PER: PIASTRE, BINARI E DISASSATORI / FINISH AVAILABLE FOR: PLATES, TRACKS AND SPACERS



Cromo
Chrome



Cromo spazzolato
Brushed chrome



Nero opaco
Matt black



Bianco opaco
Matt white

CARATTERISTICHE TECNICHE / TECHNICAL FEATURES

MATERIALI: VETRO BOROSILICATO E OTTONE / MATERIALS: BOROSILICATE GLASS AND BRASS

CAVO ELETTRICO TRASPARENTE O GOMMA NERO / TRANSPARENT ELECTRIC CABLE OR BLACK GUM

SORGENTE LUMINOSA / LIGHTING SOURCE:

- E14, E27 (IN BASE ALLA TIPOLOGIA / DEPENDING ON TYPE)
- LAMPADINA NON INCLUSA / BULB NOT INCLUDED

ON DEMAND / OPTIONAL FEATURES

- PERSONALIZZAZIONE LUNGHEZZA DEL CAVO SU RICHIESTA / CUSTOMISED CABLE LENGTH ON REQUEST
- A RICHIESTA CON COMPONENTI UL / ON DEMAND WITH UL COMPONENTS
- LAMPADA DA TAVOLO A RICHIESTA CON DIMMER / ON DEMAND WITH DIMMER PUSH BUTTON

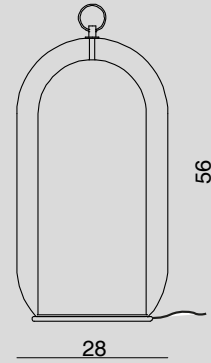
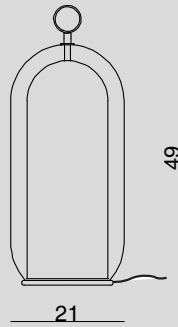
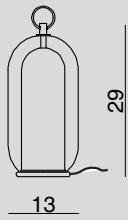

LU1530

LAMPADA DA TAVOLO / TABLE LAMP

Glass 1 x Ø 13 cm - Cable 200 cm

1 x E14 40 W

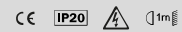

LUG1530

LAMPADA DA TAVOLO / TABLE LAMP

Glass 1 x Ø 21 cm - Cable 200 cm

1 x E27 60 W

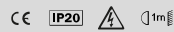

LUXXL1530

LAMPADA DA TAVOLO / TABLE LAMP

Glass 1 x Ø 28 cm - Cable 200 cm

1 x E27 60 W

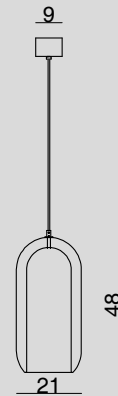
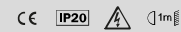

1533.1L

SOSPENSIONE A ROSONE / HANGING LAMP WITH CANOPY

Glass 1 x Ø 13 cm - Cable 150 cm

1 x E14 42 W

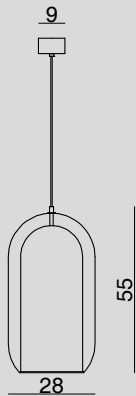
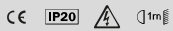

MED1533.1L

SOSPENSIONE A ROSONE / HANGING LAMP WITH CANOPY

Glass 1 x Ø 15 cm - Cable 150 cm

1 x E27 70 W

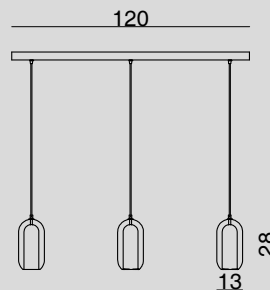
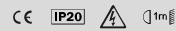

GIG1533.1L

SOSPENSIONE A ROSONE / HANGING LAMP WITH CANOPY

Glass 1 x Ø 21 cm - Cable 150 cm

1 x E27 70 W

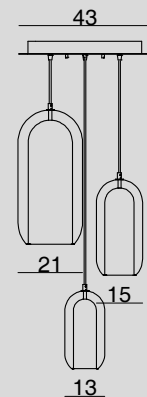
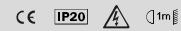

XXL1533.1L

SOSPENSIONE A ROSONE / HANGING LAMP WITH CANOPY

Glass 1 x Ø 28 cm - Cable 150 cm

1 x E27 70 W

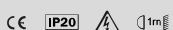

1537.120.3L

SOSPENSIONE A BINARIO / HANGING LAMP WITH TRACKS

Glass 3 x Ø 13 cm - Cable 150 cm

3 x E14 42 W

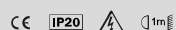

1539MX.43.3L

SOSPENSIONE A PIASTRA / HANGING LAMP WITH CEILING PLATE

Glass 3 x Ø 13-15-21 cm - Cable 150 cm

1 x E14 42 W 2 x E27 70 W

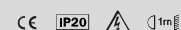



GIG1663.1L
GIG1643.1L
GIG1653.1L
Glass: amber (05), fume (08), tobacco (16)
Structure: matt black

NEW

MARK ©

DESIGN: PIETRO TUCCI (2025)

COME IL TEMPO E LA MATERIA PLASMANO OGNI COSA, COSÌ LA COLLEZIONE MARK LASCIA IL SEGNO CON LA SUA FORMA ORGANICA, CARATTERIZZATA DA IMPERFEZIONI E DEFORMAZIONI. ISPIRATA AI PIANETI, ALLE FORME ORGANICHE, AI DISCHI VOLANTI E ALLE SUPERFICI LUNARI, OGNI LAMPADA SI FA PORTATRICE DI UNA VISIONE UNICA DELLO SPAZIO.

LE TRE FORME BALL, OVAL E DISK, MODELLATE IN VETRO SOFFIATO, RACCONTANO UN PROCESSO DI TRASFORMAZIONE, DA UN VOLUME INIZIALE ALLA SUA NATURALE EVOLUZIONE.

LE IRREGOLARITÀ SONO ESPRESSIONI DI CARATTERE, DETTAGLI UNICI CHE RACCONTANO UNA STORIA, CONFERENDO A OGNI LAMPADA UN'IDENTITÀ DISTINTIVA E IRRIPETIBILE.

MARK NON È SOLO LUCE, MA UNA TRACCIA, UN'IMPRONTA DI DESIGN CHE DIALOGA CON LO SPAZIO, LASCIANDO IL SEGNO.

JUST AS TIME AND MATTER SHAPE EVERYTHING, THE MARK COLLECTION LEAVES ITS MARK WITH ITS ORGANIC FORM, CHARACTERIZED BY IMPERFECTIONS AND DEFORMATIONS. INSPIRED BY PLANETS, ORGANIC SHAPES, FLYING SAUCERS, AND LUNAR SURFACES, EACH LAMP CARRIES A UNIQUE VISION OF SPACE. THE THREE SHAPES – BALL, OVAL, AND DISK, MOLDED IN BLOWN GLASS – TELL A STORY OF TRANSFORMATION AND THE NATURAL EVOLUTION OF THE INITIAL VOLUME. THE IRREGULARITIES ARE EXPRESSIONS OF CHARACTER, UNIQUE DETAILS THAT TELL A STORY, GIVING EACH LAMP A DISTINCTIVE AND UNREPEATABLE IDENTITY. MARK IS NOT JUST LIGHT; IT IS A TRACE, A DESIGN IMPRINT THAT INTERACTS WITH SPACE, LEAVING A MARK.



LU1655.1L

Glass: transparent

Structure: satin black nickel



1643.1L
1653.1L
1663.1L

Glass: sky-blue (07), green (06), amber (05)
Structure: satin gold

**AP1661.1L**

Glass: satin white

Structure: matt white



1679MX.40X130.7L
Glass: transparent, satin white
Structure: matt black





LU1640.1L

Glass: transparent (01)

Structure: satin gold

1646.1L
1656.1L
1666.1L
Glass: satin white
Structure: matt white

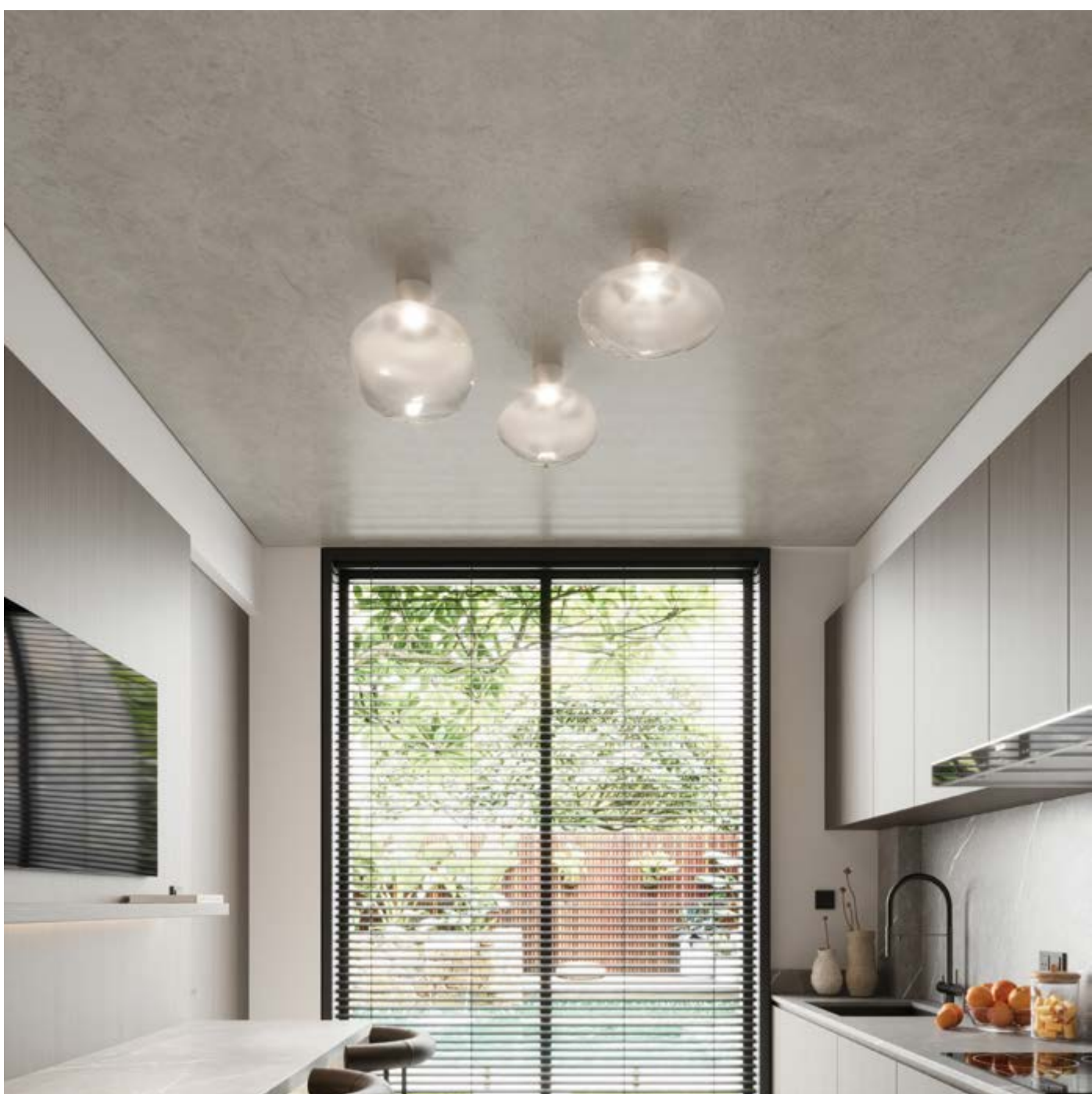



GIG1663.1L
GIG1643.1L
GIG1653.1L

Glass: satin white, fume (08)
Structure: satin black nickel



Track **AUF150**
matt black finish

3x **GIG1663**
Glass: transparent (01)
Structure: matt black



COLORI, MATERIALI, FINITURE / CMF

COLORI VETRO DISPONIBILI / AVAILABLE GLASS COLOURS

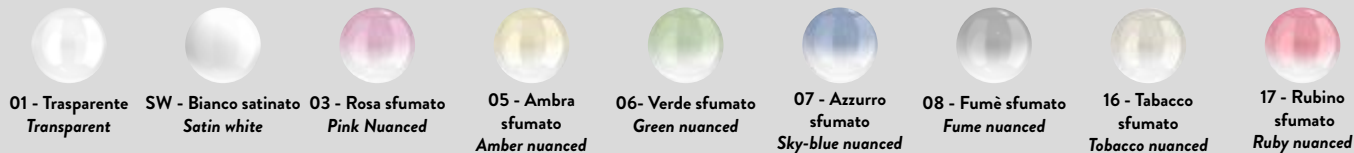

FINITURA STRUTTURALE/ CORPO METALLICO A VISTA DISPONIBILE / AVAILABLE METALLIC FINISHES FOR METAL-BODY-STRUCTURE

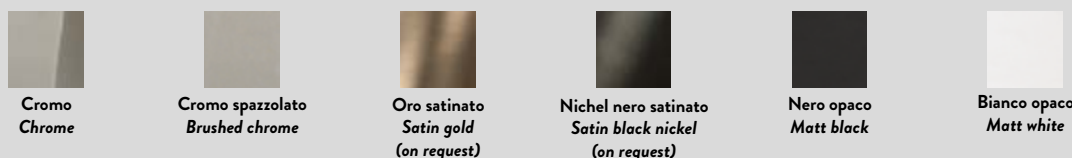

FINITURA DISPONIBILE PER: PIASTRE, BINARI E DISASSATORI / FINISH AVAILABLE FOR: PLATES, TRACKS AND SPACERS



FINITURA DISPONIBILE PER: LAMPADA DA TAVOLO E LAMPADA DA TERRA / FINISH AVAILABLE FOR: TABLE LAMP AND FLOOR LAMP

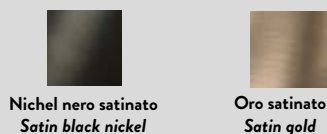

CARATTERISTICHE TECNICHE / TECHNICAL FEATURES

MATERIALI: VETRO BOROSILICATO E ALLUMINIO / MATERIALS: BOROSILICATE GLASS AND ALUMINIUM

COMPATIBILE CON CASAMBI / COMPATIBLE WITH CASAMBI

DIMMERABILE A TAGLIO DI FASE / TRIAC DIMMABLE

LED (COB) E DRIVER INCLUSI / LED (COB) AND DRIVER INCLUDED

SCHEDA LED SOSTITUIBILE DA PROFESSIONISTA / LED BOARD REPLACEABLE BY PROFESSIONAL

I LUMEN INDICATI CORRISPONDONO ALL'INTENSITÀ LUMINOSA ALL'ORIGINE DELLA SCHEDA LED / LUMEN INDICATED CORRESPONDS TO THE LUMINOUS INTENSITY AT THE ORIGIN OF THE LED BOARD

DURATA DEL LED 50.000 ORE / LED LIFESPAN 50.000 HOURS

CAVO ELETTRICO COASSIALE A BASSA TENSIONE TRASPARENTE O NERO / COAXIAL LOW VOLTAGE ELECTRIC CABLE IN TRANSPARENT OR BLACK

SORGENTE LUMINOSA / LIGHTING SOURCE:

LED DISPONIBILE PER LAMPADA DA TAVOLO E SOSPENSIONI (1643, 1653, 1663) / LEDS AVAILABLE FOR TABLE LAMP AND HANGING LAMP (1643, 1653, 1663)

• LED 1x 6W - 11,2V-12,8V - 500mA - CRI Typ 95 - 866 Lm - 144 Lm/W - 180° - 3 Step MacAdam - 2700K or 3000K

LED DISPONIBILE PER LAMPADA DA TERRA / LEDS AVAILABLE FOR FLOOR LAMP

• LED 1x 12W - 22,4V-24,8V - 500mA - CRI Typ 95 - 1.717 Lm - 144 Lm/W - 180° - 3 Step MacAdam - 2700K or 3000K

LED DISPONIBILE PER LAMPADA A SOSPENSIONE GIG, APPLIQUE E PLAFONIERE / LEDS AVAILABLE FOR GIG HANGING LAMP, WALL LAMP AND CEILING LAMP

• LED 1x 8,4W - 22,4V-24,8V - 350mA - CRI Typ 95 - 1.202 Lm - 144 Lm/W - 180° - 3 Step MacAdam - 2700K or 3000K

ON DEMAND / OPTIONAL FEATURES

- **PERSONALIZZAZIONE LUNGHEZZA DEL CAVO SU RICHIESTA / CUSTOMISED CABLE LENGTH ON REQUEST**
- **A RICHIESTA CON COMPONENTI UL / ON DEMAND WITH UL COMPONENTS**
- **DISPONIBILE SU RICHIESTA CON DRIVER DALI / AVAILABLE ON REQUEST WITH DALI DRIVER**

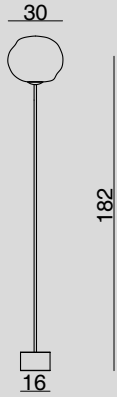

LU1645.1L

LAMPADA DA TERRA / FLOOR LAMP
 WITH DIMMER PUSH BUTTON

Glass 1 x Ø 30 cm - Cable 200 cm

1 x LED 12 W DIMM

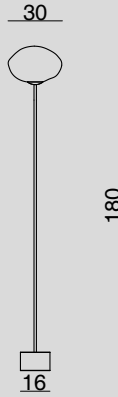
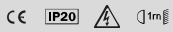

LU1655.1L

LAMPADA DA TERRA / FLOOR LAMP
 WITH DIMMER PUSH BUTTON

Glass 1 x Ø 30 cm

1 x LED 12 W DIMM

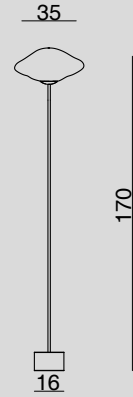
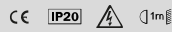

LU1665.1L

LAMPADA DA TERRA / FLOOR LAMP
 WITH DIMMER PUSH BUTTON

Glass 1 x Ø 35 cm

1 x LED 12 W DIMM

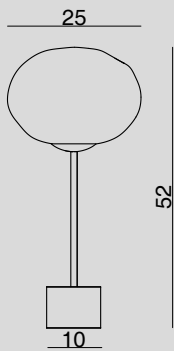
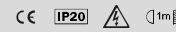

LU1640.1L

LAMPADA DA TAVOLO / TABLE LAMP
 WITH DIMMER PUSH BUTTON

Glass 1 x Ø 25 cm - Cable 200 cm

1 x LED 6 W DIMM

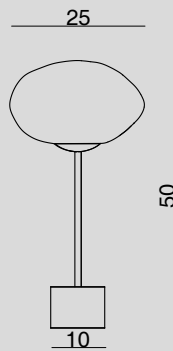
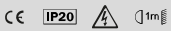

LU1650.1L

LAMPADA DA TAVOLO / TABLE LAMP
 WITH DIMMER PUSH BUTTON

Glass 1 x Ø 25 cm - Cable 200 cm

1 x LED 6 W DIMM

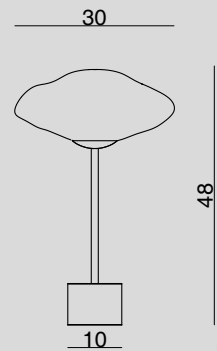
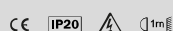

LU1660.1L

LAMPADA DA TAVOLO / TABLE LAMP
 WITH DIMMER PUSH BUTTON

Glass 1 x Ø 30 cm - Cable 200 cm

1 x LED 6 W DIMM

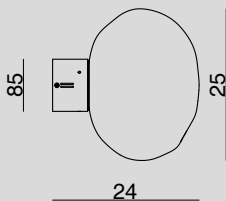
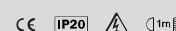

AP1641.1L

APPLIQUE / WALL LAMP

Glass 1 x Ø 25 cm

1 x LED 8,4 W DIMM

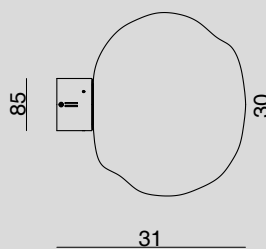
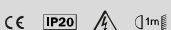

APGIG1641.1L

APPLIQUE / WALL LAMP

Glass 1 x Ø 30 cm

1 x LED 8,4 W DIMM

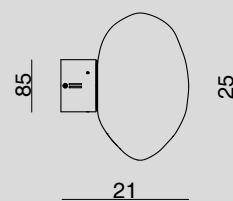
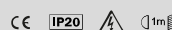

AP1651.1L

APPLIQUE / WALL LAMP

Glass 1 x Ø 25 cm

1 x LED 8,4 W DIMM

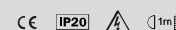

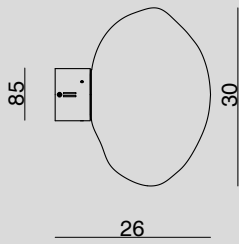

APGIG1651.1L

APPLIQUE / WALL LAMP

Glass 1 x Ø 30 cm

1 x LED 8,4 W DIMM

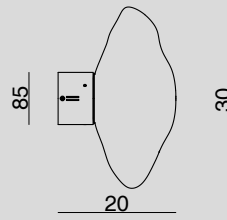
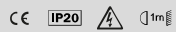

AP1661.1L

APPLIQUE / WALL LAMP

Glass 1 x Ø 30 cm

1 x LED 8,4 W DIMM

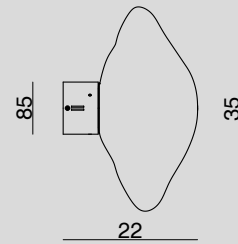
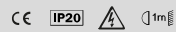

APGIG1661.1L

APPLIQUE / WALL LAMP

Glass 1 x Ø 35 cm

1 x LED 8,4 W DIMM

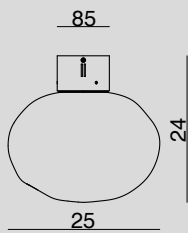
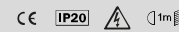

1646.1L

PLAFONIERA / CEILING LAMP

Glass 1 x Ø 25 cm

1 x LED 8,4 W DIMM

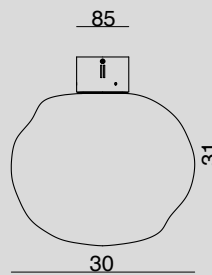
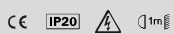

GIG1646.1L

PLAFONIERA / CEILING LAMP

Glass 1 x Ø 30 cm

1 x LED 8,4 W DIMM

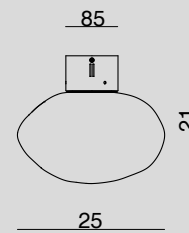
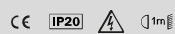

1656.1L

PLAFONIERA / CEILING LAMP

Glass 1 x Ø 25 cm

1 x LED 8,4 W DIMM

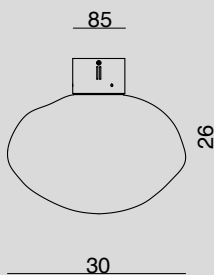
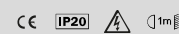

GIG1656.1L

PLAFONIERA / CEILING LAMP

Glass 1 x Ø 30 cm

1 x LED 8,4 W DIMM

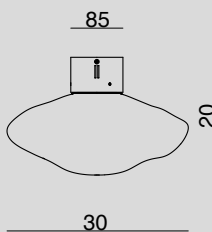
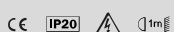

1666.1L

PLAFONIERA / CEILING LAMP

Glass 1 x Ø 30 cm

1 x LED 8,4 W DIMM

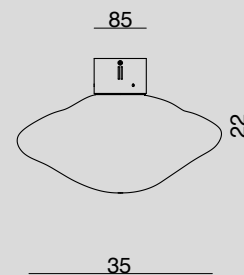
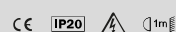

GIG1666.1L

PLAFONIERA / CEILING LAMP

Glass 1 x Ø 35 cm

1 x LED 8,4 W DIMM

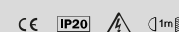



1643.1L
 SOSPENSIONE A ROSONE / HANGING
 LAMP WITH CANOPY
 Glass 1 x Ø 25 cm - Cable 200 cm
 1 x LED 6 W DIMM

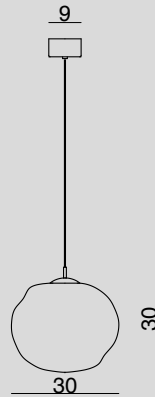
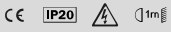

GIG1643.1L
 SOSPENSIONE A ROSONE / HANGING
 LAMP WITH CANOPY
 Glass 1 x Ø 30 cm - Cable 200 cm
 1 x LED 8,4 W DIMM

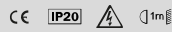

1653.1L
 SOSPENSIONE A ROSONE / HANGING
 LAMP WITH CANOPY
 Glass 1 x Ø 25 cm
 1 x LED 6 W DIMM

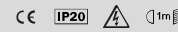

GIG1653.1L
 SOSPENSIONE A ROSONE / HANGING
 LAMP WITH CANOPY
 Glass 1 x Ø 30 cm - Cable 200 cm
 1 x LED 8,4 W DIMM

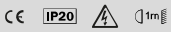

1663.1L
 SOSPENSIONE A ROSONE / HANGING
 LAMP WITH CANOPY
 Glass 1 x Ø 30 cm - Cable 200 cm
 1 x LED 6 W DIMM

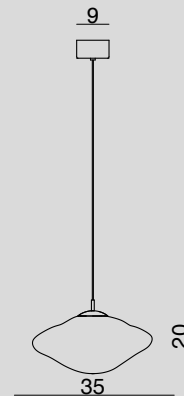
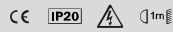

GIG1663.1L
 SOSPENSIONE A ROSONE / HANGING
 LAMP WITH CANOPY
 Glass 1 x Ø 35 cm - Cable 200 cm
 1 x LED 8,4 W DIMM

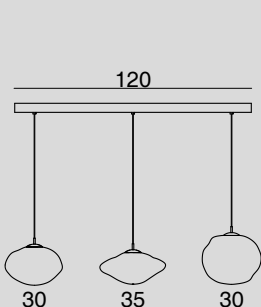
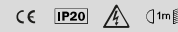

GIG1677MX.120.3L
 SOSPENSIONE A BINARIO / HANGING
 LAMP WITH TRACKS
 Glass 3 x Ø 30 - 35 - 30 cm - Cable 200 cm
 3 x LED 8,4 W DIMM

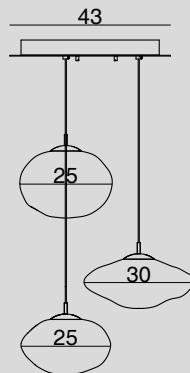
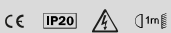

1679MX.43.3L
 SOSPENSIONE A PIASTRA / HANGING
 LAMP WITH CEILING PLATE
 Glass 3 x Ø 25 - 30 - 25 cm - Cable 200 cm
 3 x LED 6 W DIMM

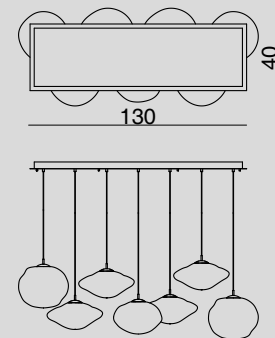
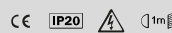

1679MX.40X130.7L
 SOSPENSIONE A PIASTRA / HANGING
 LAMP WITH CEILING PLATE
 Glass 7 x Ø 30-30-35 cm - Cable 200 cm
 7 x LED 8,4 W DIMM

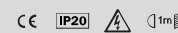



1383.1L
GIG1383.1L
Glass: amber, fume



TAO[©]

DESIGN: PIETRO TUCCI (2014)





2x 1383.1L
1x GIG1383.1L
Glass: tobacco



9x GIG1383.1L
Glass: transparent, amber, tobacco





COLORI, MATERIALI, FINITURE / CMF

COLORI VETRO DISPONIBILI / AVAILABLE GLASS COLOURS

01 - Trasparente
Transparent



03 - Rosa
Pink



05 - Ambra
Amber



06 - Verde
Green



07 - Azzurro
Sky-Blue



08 - Fumè
Fume



16 - Tabacco
Tobacco



17 - Rubino
Ruby

COLORI VETRO METALLIZZATO DISPONIBILI / METALLIC GLASS COLOURS AVAILABLE

Oro rosa
Rose gold



Titanio
Titanium

FINITURA STRUTTURA/ CORPO METALLICO A VISTA DISPONIBILE / AVAILABLE METALLIC FINISHES FOR METAL-BODY-STRUCTURE

Cromo
Chrome

FINITURA DISPONIBILE PER: PIASTRE, BINARI E DISASSATORI / FINISH AVAILABLE FOR: PLATES, TRACKS AND SPACERS

Cromo
Chrome



Cromo spazzolato
Brushed chrome



Nero opaco
Matt black



Bianco opaco
Matt white

CARATTERISTICHE TECNICHE / TECHNICAL FEATURES

MATERIALI: VETRO BOROSILICATO E OTTONE / MATERIALS: BOROSILICATE GLASS AND BRASS

CAVO ELETTRICO TRASPARENTE, A RICHIESTA: TESSILE NERO / TRANSPARENT ELECTRIC CABLE, ON DEMAND: BLACK TEXTILE

SORGENTE LUMINOSA / LIGHTING SOURCE:

- E27, G9 (IN BASE ALLA TIPOLOGIA / DEPENDING ON TYPE)
- LAMPADINA NON INCLUSA / BULB NOT INCLUDED

ON DEMAND / OPTIONAL FEATURES

- **PERSONALIZZAZIONE LUNGHEZZA DEL CAVO SU RICHIESTA / CUSTOMISED CABLE LENGTH ON REQUEST**
- **A RICHIESTA CON COMPONENTI UL / ON DEMAND WITH UL COMPONENTS**

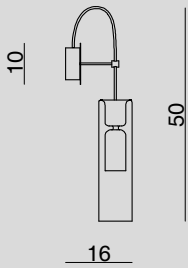

AP1381.1L

APPLIQUE / WALL LAMP

Glass 1 x Ø 8 cm - Cable 50 cm

1 x G9 33 W

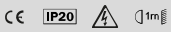

1383.1L

SOSPENSIONE A ROSONE / HANGING LAMP WITH CANOPY

Glass 1 x Ø 8 cm - Cable 150 cm

1 x G9 33 W

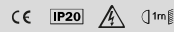

GIG1383.1L

SOSPENSIONE A ROSONE / HANGING LAMP WITH CANOPY

Glass 1 x Ø 10 cm - Cable 150 cm

1 x E27 70 W

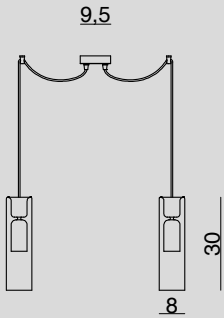
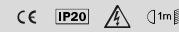

1383.2L

SOSPENSIONE A ROSONE / HANGING LAMP WITH CANOPY

Glass 2 x Ø 8 cm - Cable 250 cm

2 x G9 33 W

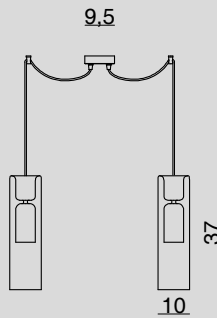
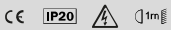

GIG1383.2L

SOSPENSIONE A ROSONE / HANGING LAMP WITH CANOPY

Glass 2 x Ø 10 cm - Cable 250 cm

2 x E27 70 W

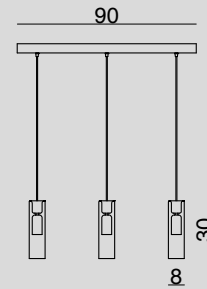
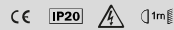

1387.90.3L

SOSPENSIONE A BINARIO / HANGING LAMP WITH TRACKS

Glass 3 x Ø 8 cm - Cable 150 cm

3 x G9 33 W

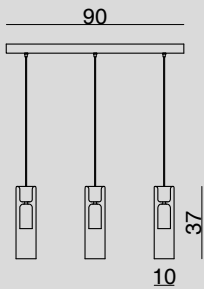
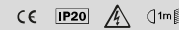

GIG1387.90.3L

SOSPENSIONE A BINARIO / HANGING LAMP WITH TRACKS

Glass 3 x Ø 10 cm - Cable 150 cm

3 x E27 70 W

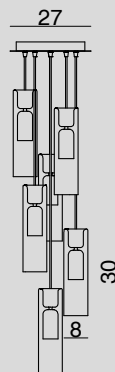
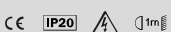

1389.6L

SOSPENSIONE A PIASTRA / HANGING LAMP WITH CEILING PLATE

Glass 6 x Ø 8 cm - Cable 150 cm

6 x G9 33 W

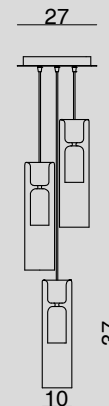
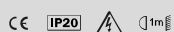

GIG1389.3L

SOSPENSIONE A PIASTRA / HANGING LAMP WITH CEILING PLATE

Glass 3 x Ø 10 cm - Cable 150 cm

3 x E27 70 W

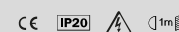

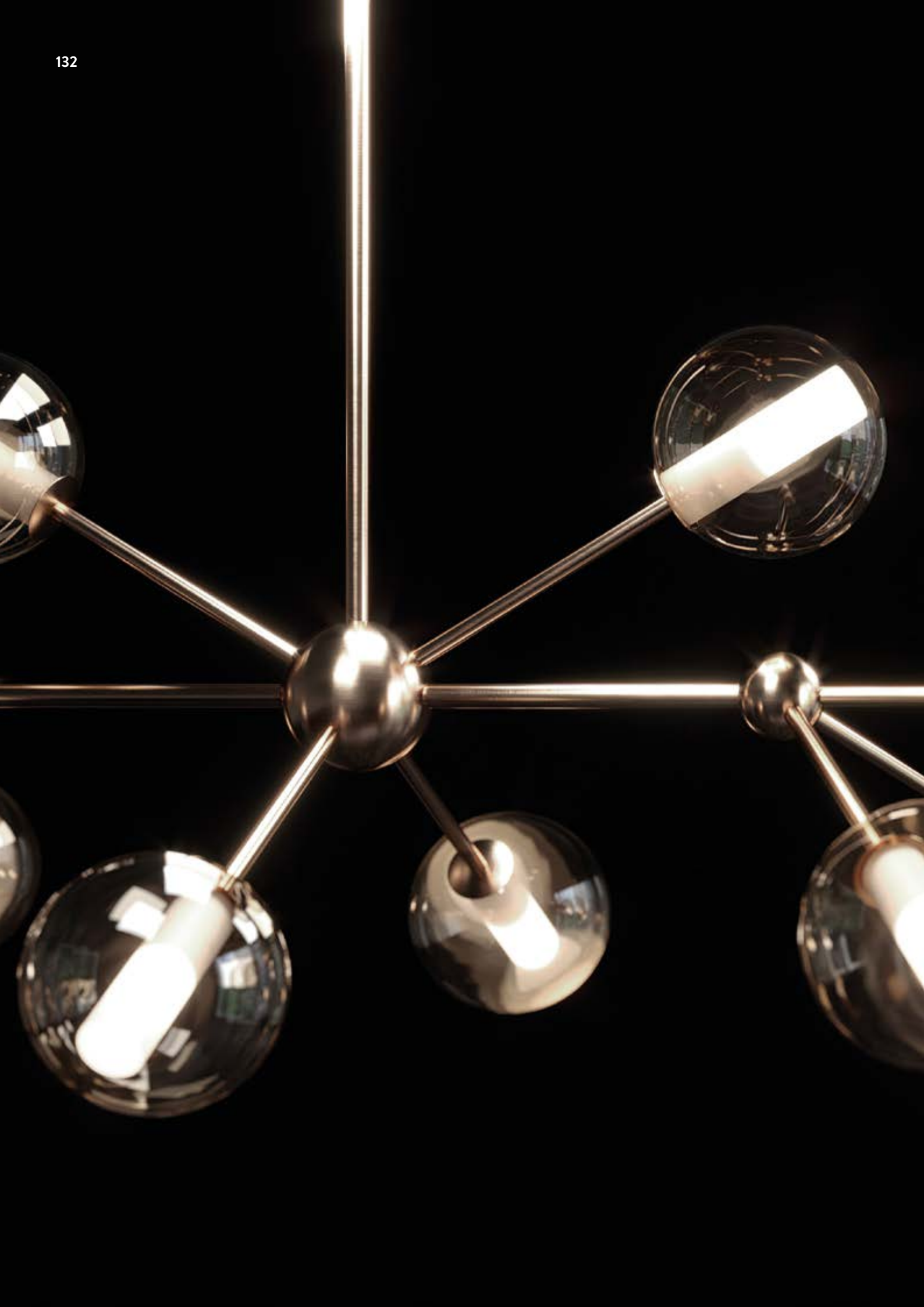

MIREA®

DESIGN: MASSIMILIANO TUCCI
WITH THE COLLABORATION OF CRISTIAN LI VOI (2021)

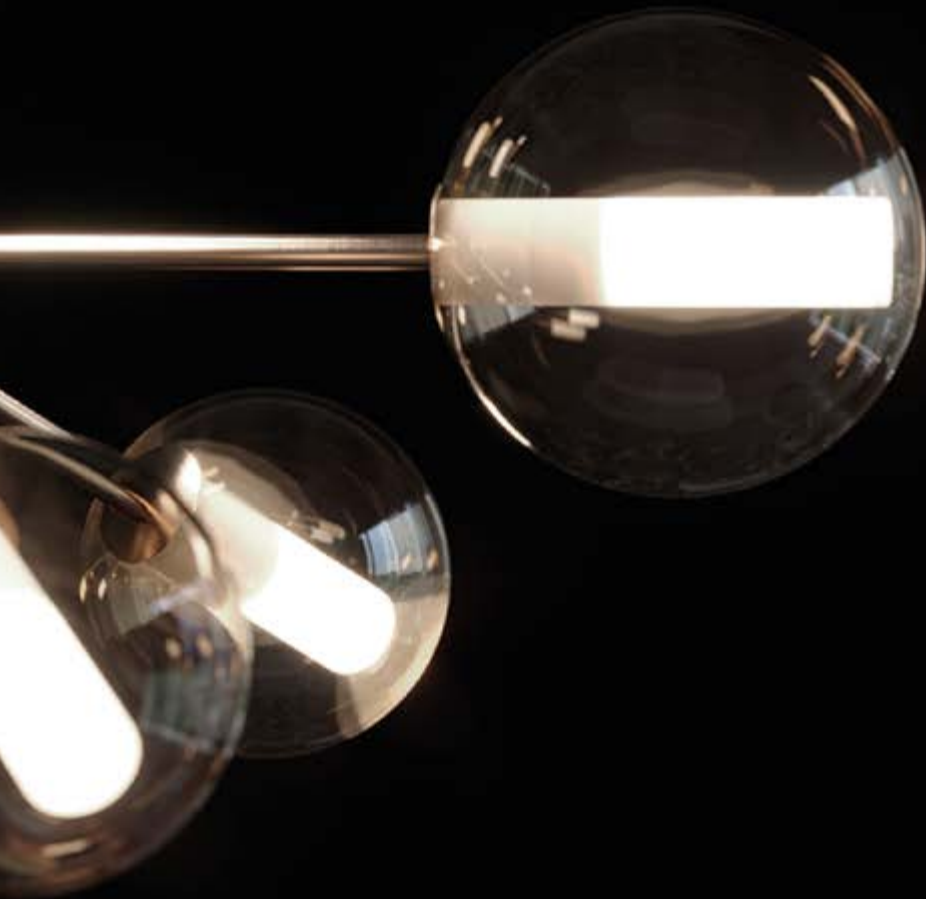



LU1570.1L

Glass: amber (05)

Structure: satin rose gold



1574.10.LIN
Glass: amber (05)
Structure: satin rose gold





AP1571.14.1L

Glass: transparent

Structure: satin black nickel

AP1571.2L

Glass: transparent

Structure: satin gold





1574.12+4/16L

Glass: fume (08)

Structure: satin black nickel





COLORI, MATERIALI, FINITURE / CMF

COLORI VETRO DISPONIBILI / AVAILABLE GLASS COLOURS



01 - Trasparente
Transparent



03 - Rosa
Pink



05 - Ambra
Amber



06 - Verde
Green



07 - Azzurro
Sky-Blue



08 - Fumè
Fume



16 - Tabacco
Tobacco



17 - Rubino
Ruby

FINITURA STRUTTURA/ CORPO METALLICO A VISTA DISPONIBILE / AVAILABLE METALLIC FINISHES FOR METAL-BODY-STRUCTURE



Oro satinato
Satin gold



Nichel nero satinato
Satin black nickel



Oro rosa satinato
Satin rose gold

CARATTERISTICHE TECNICHE / TECHNICAL FEATURES

MATERIALI: VETRO BOROSILICATO E OTTONE / MATERIALS: BOROSILICATE GLASS AND BRASS

SORGENTE LUMINOSA / LIGHTING SOURCE:

- G9 - 33W - 220V-240V
- LAMPADINA NON INCLUSA / BULB NOT INCLUDED
- CONSIGLIATA LAMPADINA LED 3W / RECOMMENDED 3W LED BULB

ON DEMAND / OPTIONAL FEATURES

- PER LAMPADARI: PERSONALIZZAZIONE LUNGHEZZA DELL'ASTA DI SOSPENSIONE SU RICHIESTA (PIÙ CORTA/PIÙ LUNGA) / FOR CHANDELIERS: CUSTOMISATION OF HANGING ROD LENGTH ON REQUEST (SHORTER/LONGER)
- PER SOSPENSIONI: PERSONALIZZAZIONE LUNGHEZZA DEL CAVO SU RICHIESTA / FOR HANGING LAMPS: CUSTOMISATION OF CABLE LENGTH ON REQUEST
- A RICHIESTA CON COMPONENTI UL / ON DEMAND WITH UL COMPONENTS

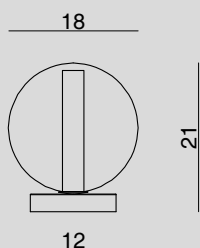

LU1570.1L

LAMPADA DA TAVOLO / TABLE LAMP

Glass 1 x Ø 18 cm - Cable 200 cm

1 x G9 33 W

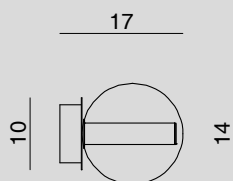
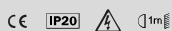

AP1571.14.1L

APPLIQUE / WALL LAMP

Glass 1 x Ø 14 cm

1 x G9 33 W

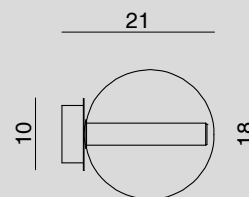
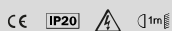

AP1571.18.1L

APPLIQUE / WALL LAMP

Glass 1 x Ø 18 cm

1 x G9 33 W

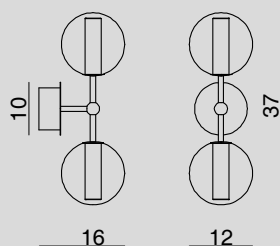
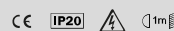

AP1571.12.2L

APPLIQUE / WALL LAMP

Glass 2 x Ø 12 cm

2 x G9 33 W

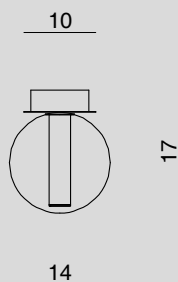
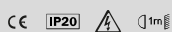

1576.14.1L

PLAFONIERA / CEILING LAMP

Glass 1 x Ø 14 cm

1 x G9 33 W

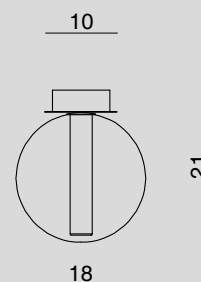
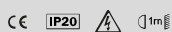

1576.18.1L

PLAFONIERA / CEILING LAMP

Glass 1 x Ø 18 cm

1 x G9 33 W

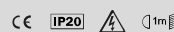

1573.14.1L

SOSPENSIONE A ROSONE / HANGING LAMP WITH CANOPY

Glass 1 x Ø 14 cm - Cable 150 cm

1 x G9 33 W

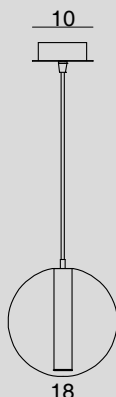
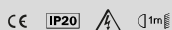

1573.18.1L

SOSPENSIONE A ROSONE / HANGING LAMP WITH CANOPY

Glass 1 x Ø 18 cm - Cable 150 cm

1 x G9 33 W

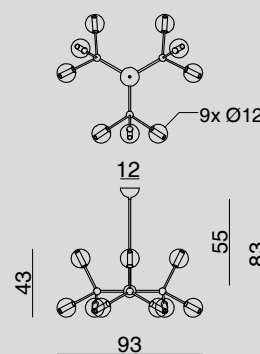
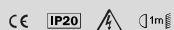

1574.9L

LAMPADARIO / CHANDELIER

Glass 9 x Ø 12 cm

9 x G9 33 W

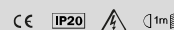

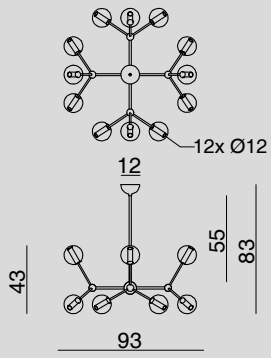

1574.12L

LAMPADARIO / CHANDELIER

Glass 12 x Ø 12 cm

12 x G9 33 W

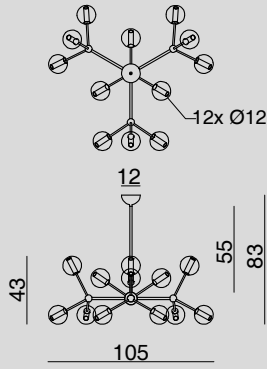
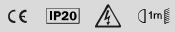

1574.9.3.12L

LAMPADARIO / CHANDELIER

Glass 12 x Ø 12 cm

12 x G9 33 W

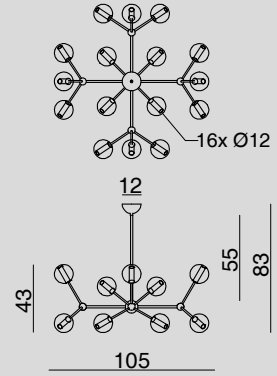
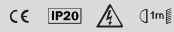

1574.12.4.16L

LAMPADARIO / CHANDELIER

Glass 16 x Ø 12 cm

16 x G9 33 W

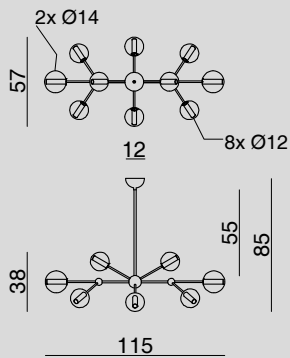
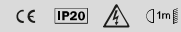

1574.10L.LIN

LAMPADARIO / CHANDELIER

Glass 10 x Ø 12-14 cm

10 x G9 33 W

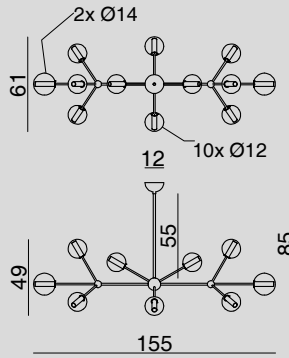
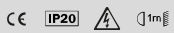

1574.12L.LIN

LAMPADARIO / CHANDELIER

Glass 12 x Ø 12-14 cm

12 x G9 33 W

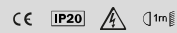

DETTAGLI PRODOTTO
PRODUCT DETAILS



1393
GIG1393
XXL1393
Glass: amber (05), tobacco (16)



FLUTE ©

DESIGN: PIETRO TUCCI (2009)



AP1391.1L
Glass: tobacco (16)
Structure: matt black

LUGIG1390.1L
Glass: tobacco (16)
Structure: matt black

GIG1393.2L
Glass: tobacco (16)
Structure: matt black



1399MX.43.3L
Glass: black
Plate: matt black



COLORI, MATERIALI, FINITURE / CMF

COLORI VETRO DISPONIBILI / AVAILABLE GLASS COLOURS



01 - Trasparente
Transparent



03 - Rosa
Pink



05 - Ambra
Amber



06 - Verde
Green



07 - Azzurro
Sky-Blue



08 - Fumè
Fume



16 - Tabacco
Tobacco



17 - Rubino
Ruby

COLORI VETRO METALLIZZATO DISPONIBILI / METALLIC GLASS COLOURS AVAILABLE



Bronzo
Bronze



Nero
Black



Titanio
Titanium

FINITURA STRUTTURA/ CORPO METALLICO A VISTA DISPONIBILE / AVAILABLE METALLIC FINISHES FOR METAL-BODY-STRUCTURE



Cromo
Chrome



Cromo spazzolato
Brushed chrome

FINITURA DISPONIBILE PER: PIASTRE, BINARI E DISASSATORI / FINISH AVAILABLE FOR: PLATES, TRACKS AND SPACERS



Cromo
Chrome



Cromo spazzolato
Brushed chrome



Nero opaco
Matt black



Bianco opaco
Matt white

CARATTERISTICHE TECNICHE / TECHNICAL FEATURES

MATERIALI: VETRO BOROSILICATO E OTTONE / MATERIALS: BOROSILICATE GLASS AND BRASS

CAVO ELETTRICO TRASPARENTE, A RICHIESTA: TESSILE NERO / TRANSPARENT ELECTRIC CABLE, ON DEMAND: BLACK TEXTILE

SORGENTE LUMINOSA / LIGHTING SOURCE:

- E14, E27 (IN BASE ALLA TIPOLOGIA / DEPENDING ON TYPE)
- LAMPADINA NON INCLUSA / BULB NOT INCLUDED

ON DEMAND / OPTIONAL FEATURES

- PERSONALIZZAZIONE LUNGHEZZA DEL CAVO SU RICHIESTA / CUSTOMISED CABLE LENGTH ON REQUEST
- A RICHIESTA CON COMPONENTI UL / ON DEMAND WITH UL COMPONENTS
- TIGE INTERNA A RICHIESTA NERO OPACO (STANDARD CROMO) / INNER METAL TUBE, ON DEMAND MATT BLACK (STANDARD CHROME)



LU1390.1L

LAMPADA DA TAVOLO / TABLE LAMP

Glass 1 x Ø 12 cm - Cable 200 cm

1 x E14 60 W

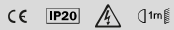

LUG1390.1L

LAMPADA DA TAVOLO / TABLE LAMP

Glass 1 x Ø 16 cm - Cable 200 cm

1 x E27 105 W

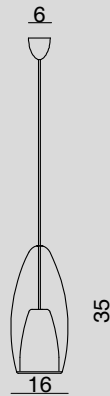
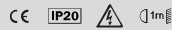

AP1391.1L

APPLIQUE / WALL LAMP

Glass 1 x Ø 12 cm - Cable 50 cm

1 x E14 40 W

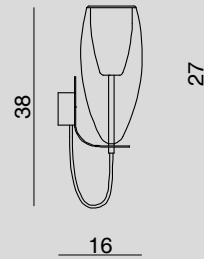
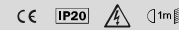

1393.1L

SOSPENSIONE A ROSONE / HANGING LAMP WITH CANOPY

Glass 1 x Ø 12 cm - Cable 150 cm

1 x E14 60 W

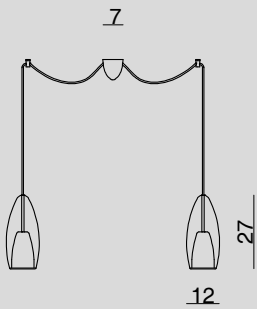
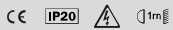

GIG1393.1L

SOSPENSIONE A ROSONE / HANGING LAMP WITH CANOPY

Glass 1 x Ø 16 cm - Cable 150 cm

1 x E27 105 W

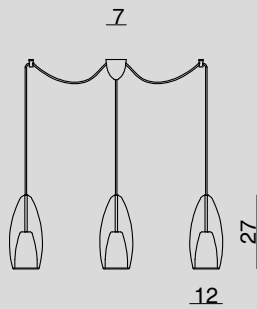
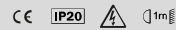

XXL1393.1L

SOSPENSIONE A ROSONE / HANGING LAMP WITH CANOPY

Glass 1 x Ø 20 cm - Cable 150 cm

1 x E27 105 W

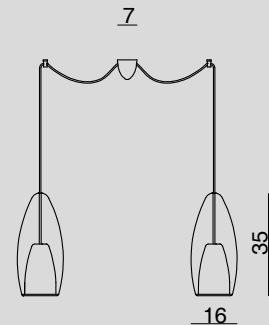
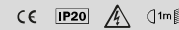

1393.2L

SOSPENSIONE A ROSONE / HANGING LAMP WITH CANOPY

Glass 2 x Ø 12 cm - Cable 250 cm

2 x E14 60 W

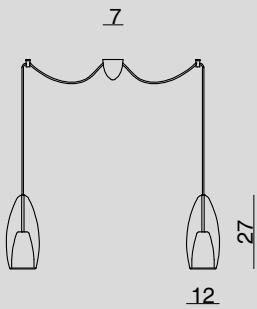
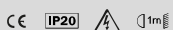

1393.3L

SOSPENSIONE A ROSONE / HANGING LAMP WITH CANOPY

Glass 3 x Ø 12 cm - Cable 250 cm

3 x E14 60 W

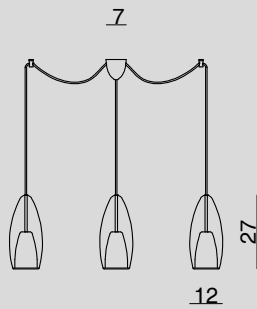
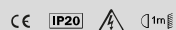

GIG1393.2L

SOSPENSIONE A ROSONE / HANGING LAMP WITH CANOPY

Glass 2 x Ø 16 cm - Cable 250 cm

2 x E27 105 W

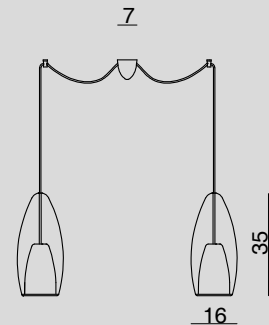

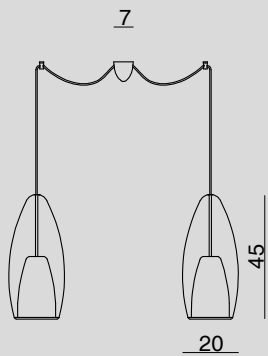

XXL1393.2L

SOSPENSIONE A ROSONE / HANGING LAMP WITH CANOPY

Glass 2 x Ø 20 cm - Cable 250 cm

2 x E27 105 W

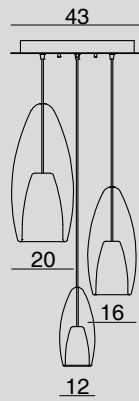
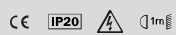

1399MX.43.3L

SOSPENSIONE A PIASTRA / HANGING LAMP WITH CEILING PLATE

Glass 3 x Ø 12-16-20 cm - Cable 150 cm

1 x E14 60 W 2 x E27 105 W

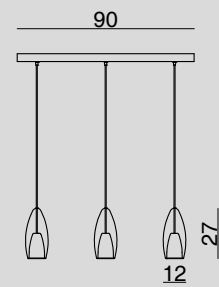
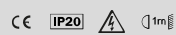

1397.90.3L

SOSPENSIONE A BINARIO / HANGING LAMP WITH TRACKS

Glass 3 x Ø 12 cm - Cable 150 cm

3 x E14 60 W

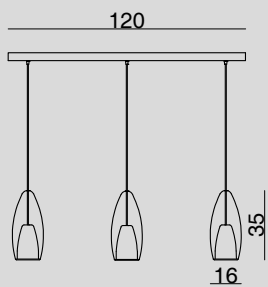
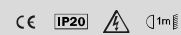

GIG1397.120.3L

SOSPENSIONE A BINARIO / HANGING LAMP WITH TRACKS

Glass 3 x Ø 16 cm - Cable 150 cm

3 x E27 105 W

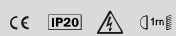

DETTAGLI PRODOTTO
PRODUCT DETAILS







FOLD[©]

DESIGN: CRISTIAN LI VOI (2020)



LA COLLEZIONE FOLD È DISEGNATA DA CRISTIAN LI VOI NEL 2020. IL TERMINE FOLD SIGNIFICA PIEGARE, ED IN QUESTO CASO PUÒ ESSERE TRADOTTO NELLA SUA FORMA PIÙ SEMPLICE, CIOÈ L'AZIONE CHE SI APPLICA AD UN OGGETTO IN MODO TALE CHE ASSUMA UNA FORMA DIVERSA DA QUELLA INIZIALE, DIVENTANDO QUALCOSA DI NUOVO.

I CONTRASTI TRA PRIMA E DOPO, SEMPLICE E COMPLESSO, LONTANO E VICINO, SONO TUTTI PARTE DELLA RICERCA CHE HA PORTATO ALLA NASCITA DI FOLD. LA FORMA DELLA LAMPADA, ESTERNAMENTE, RIVELA UNA SILHOUETTE DOVE LA PARTE SUPERIORE ED INFERIORE SONO LONTANE.

IN QUEST'AREA, LA LUCE GIOCA NELLO SPAZIO E CI PERMETTE DI ANDARE OLTRE CON LO SGUARDO FINO AL CENTRO. QUA IL PROFILO SUBISCE UNA VARIAZIONE, SOPRA E SOTTO PERDONO DI SIGNIFICATO CREANDO UN TUTT'UNO CON IL BAGLIORE, UN'ILLUSIONE, CHE, PER UN MOMENTO, NON CI PERMETTE DI COMPRENDERE DA DOVE VENGA LA LUCE. LA FLESSIONE CENTRALE DI FOLD PERMETTE DI INTEGRARE NEL VETRO IL CORPO ILLUMINANTE, AGGIUNGENDO UNA FUNZIONE TECNICA AL VALORE ESTETICO. QUESTO È TUTTO CIÒ CHE DERIVA DA UN GESTO SEMPLICE E COMPLESSO ALLO STESSO TEMPO, UNA PIEGA, FOLD.

FOLD COLLECTION DESIGN BY CRISTAN LI VOI.
THE TERM "FOLD" IN ITS SIMPLEST INTERPRETATION IS AN ACTION APPLIED TO AN OBJECT IN SUCH A WAY THAT IT TAKES ON A NEW SHAPE, BECOMING SOMETHING RATHER DIFFERENT. A FOLD'S CONTRAST BETWEEN BEFORE AND AFTER, SIMPLE AND COMPLEX, AND FAR AND NEAR, ARE ALL PART OF THE RESEARCH THAT LED TO THE CREATION OF THE LAMP CALLED FOLD. FOLD'S OUTLINE TRACES A SILHOUETTE THAT SETS ITS UPPER AND LOWER PARTS FAR APART, ALLOWING LIGHT TO PLAY IN THE GAP IN-BETWEEN, DRAWING OUR GAZE TOWARDS ITS CENTRE. HERE, THE FORM UNDERGOES A STRIKING CHANGE. ABOVE AND BELOW LOSE MEANING, CREATING A ONENESS, AN ILLUSION THAT OBFUSCATES WHERE EXACTLY THE LIGHT COMES FROM. ITS SOURCE IS, IN FACT, FULLY INCORPORATED WITHIN THE GLASS OF FOLD'S CENTRAL CREASE, ADDING TECHNICAL ACCOMPLISHMENT TO THE LAMP'S HIGH AESTHETIC VALUE. ALL THIS COMES FROM A GESTURE AT ONCE SIMPLE AND COMPLEX, A FOLD.



LUGI1515.1L
Glass: transparent
Structure: matt black

**GIG1513.1L**

Glass: transparent

2x GIG1513.1L
Glass: transparent





3x GIG1516.1L
Glass: transparent
Structure: matt black



AP1511.1L
Glass: transparent (01)
Structure: matt black



COLORI, MATERIALI, FINITURE / CMF

COLORI VETRO DISPONIBILI / AVAILABLE GLASS COLOURS



01 - Trasparente
Transparent



03 - Rosa
Pink



05 - Ambra
Amber



06 - Verde
Green



07 - Azzurro
Sky-Blue



08 - Fumè
Fume



16 - Tabacco
Tobacco



17 - Rubino
Ruby

FINITURA STRUTTURALE/ CORPO METALLICO A VISTA DISPONIBILE / AVAILABLE METALLIC FINISHES FOR METAL-BODY-STRUCTURE



Cromo
Chrome



Nero opaco
Matt black

FINITURA DISPONIBILE PER: PIASTRE, BINARI E DISASSATORI / FINISH AVAILABLE FOR: PLATES, TRACKS AND SPACERS



Cromo
Chrome



Cromo spazzolato
Brushed chrome



Nero opaco
Matt black



Bianco opaco
Matt white

CARATTERISTICHE TECNICHE / TECHNICAL FEATURES

MATERIALI: VETRO BOROSILICATO E ALLUMINIO / MATERIALS: BOROSILICATE GLASS AND ALUMINIUM

COMPATIBILE CON CASAMBI / COMPATIBLE WITH CASAMBI

DIMMERABILE A TAGLIO DI FASE / TRIAC DIMMABLE

LED (COB) E DRIVER INCLUSI / LED (COB) AND DRIVER INCLUDED

SCHEDA LED SOSTITUIBILE DA PROFESSIONISTA / LED BOARD REPLACEABLE BY PROFESSIONAL

I LUMEN INDICATI CORRISPONDONO ALL'INTENSITÀ LUMINOSA ALL'ORIGINE DELLA SCHEDA LED / LUMEN INDICATED CORRESPONDS TO THE LUMINOUS INTENSITY AT THE ORIGIN OF THE LED BOARD

DURATA DEL LED 50.000 ORE / LED LIFESPAN 50.000 HOURS

CAVO ELETTRICO GOMMA NERO / ELECTRIC CABLE BLACK GUM

SORGENTE LUMINOSA / LIGHTING SOURCE:

LED DISPONIBILE PER LAMPADA DA TERRA E SOSPENSIONI / LEDS AVAILABLE FOR FLOOR LAMP AND HANGING LAMP

• LED 1x 17,4W - 32V-40V - 500mA - CRI Typ 95 - 2.370 Lm - 134 Lm/W - 180° - 3 Step MacAdam - 2700K or 3000K

LED DISPONIBILE PER LAMPADA APPLIQUE E PLAFONIERE / LEDS AVAILABLE FOR WALL LAMP AND CEILING LAMP

• LED 1x 12,8W - 32V-40V - 350mA - CRI Typ 95 - 1.615 Lm - 126 Lm/W - 180° - 3 Step MacAdam - 2700K or 3000K

ON DEMAND / OPTIONAL FEATURES

- **PERSONALIZZAZIONE LUNGHEZZA DEL CAVO SU RICHIESTA / CUSTOMISED CABLE LENGTH ON REQUEST**
- **A RICHIESTA CON COMPONENTI UL / ON DEMAND WITH UL COMPONENTS**
- **DISPONIBILE SU RICHIESTA CON DRIVER DALI / AVAILABLE ON REQUEST WITH DALI DRIVER**
- **FOLD 1513 E GIG1513 DISPONIBILE CON SISTEMA UP E DOWN / FOLD 1513 AND GIG1513 AVAILABLE WITH UP AND DOWN SYSTEM**

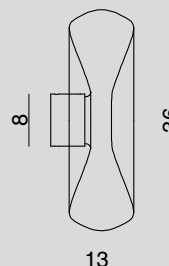
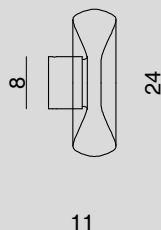
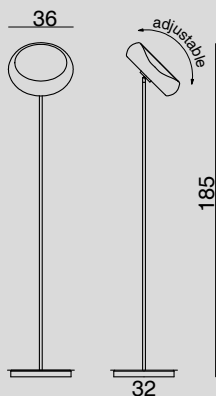

LUGIG1515.1L

LAMPADA DA TERRA / FLOOR LAMP WITH DIMMER PUSH BUTTON

Glass 1 x Ø 36 cm - Cable 200 cm

1 x LED 17,4 W DIMM

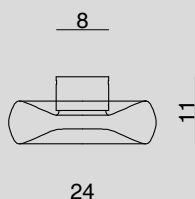
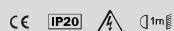

AP1511.1L

APPLIQUE / WALL LAMP

Glass 1 x Ø 24 cm

1 x LED 12,8 W DIMM

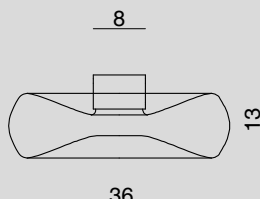
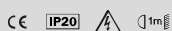

APGIG1511.1L

APPLIQUE / WALL LAMP

Glass 1 x Ø 36 cm

1 x LED 12,8 W DIMM

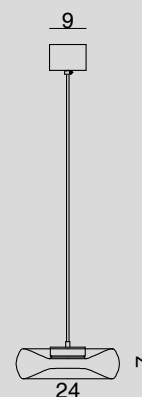
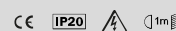

1516.1L

PLAFONIERA / CEILING LAMP

Glass 1 x Ø 24 cm

1 x LED 12,8 W DIMM

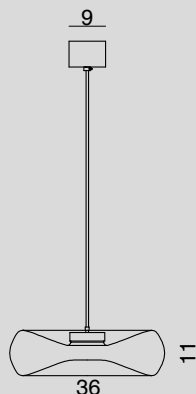
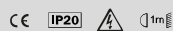

GIG1516.1L

PLAFONIERA / CEILING LAMP

Glass 1 x Ø 36 cm

1 x LED 12,8 W DIMM

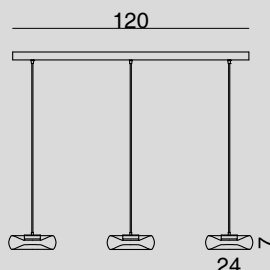
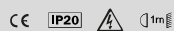

1513.1L

SOSPENSIONE A ROSONE / HANGING LAMP WITH CANOPY

Glass 1 x Ø 24 cm - Cable 150 cm

1 x LED 17,4 W DIMM

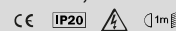

GIG1513.1L

SOSPENSIONE A ROSONE / HANGING LAMP WITH CANOPY

Glass 1 x Ø 36 cm - Cable 150 cm

1 x LED 17,4 W DIMM

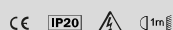

1517.120.3L

SOSPENSIONE A BINARIO / HANGING LAMP WITH TRACKS

Glass 3 x Ø 24 cm - Cable 150 cm

3 x LED 17,4 W DIMM

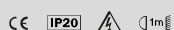





DALMA[©]

DESIGN:  MARCANTONIO[®] (2024)





DALMA È UNA NUOVA SUGGERIZIONE LUMINOSA DI CANGINI & TUCCI FIRMATA MARCANTONIO. ANCORA UNA VOLTA LA TECNOLOGIA INCONTRA LA RICERCA ESTETICA. LE FORME ONDULATE DI DALMA RICORDANO UN FENOMENO NATURALE, CREANDO UNA PRESENZA ASTRATTA COME UN'ANIMA LUMINOSA, UN'ONDA MORBIDA. DALMA EVOCA UN MOVIMENTO CALDO, QUASI COME UNA CELLULA CHE SI DIVIDE. UN UOVO TRASPARENTE CHE RACCHIUDE UN NUCLEO SINUOSO DALLE LINEE FEMMINILI COME QUELLE DI UNA VENERE PRIMORDIALE. DALMA È SEMPLICE MA HA LA FORZA DELL'ICONA.

DALMA IS A NEW LIGHTING DESIGN FROM CANGINI & TUCCI BY MARCANTONIO.

ONCE AGAIN TECHNOLOGY MEETS AESTHETIC RESEARCH. DALMA'S WAVE-LIKE SHAPES REMIND US OF A NATURAL PHENOMENON, CREATING AN ABSTRACT PRESENCE LIKE A LUMINOUS SOUL, A SOFT WAVE. DALMA SUGGESTS A WARM MOVEMENT, ALMOST AS A DIVIDING CELL. A TRANSPARENT EGG ENCLOSING A SINUOUS NUCLEUS WITH SINUOUS FEMININE LINES LIKE THOSE OF A PRIMORDIAL VENUS. DALMA IS SIMPLE BUT HAS THE POWER OF THE ICON.



1619MX.43.3L

Glass: tobacco (05), sky-blue (07), fume (08)
Structure: champagne

LU1614.1L

Glass: fume (08)
Structure: champagne

**LUGI1615.1L**

Glass: tobacco

Structure: black carbon



LU1610.1L
Glass: *fume (08)*
Structure: *french gold*



1613.1L

GIG1613.1L

Glass: tobacco (05), sky-blue (07), fume (08)

Structure: champagne



GIG1613.1L
Glass: sky-blue (07)
Structure: champagne



COLORI, MATERIALI, FINITURE / CMF

COLORI VETRO DISPONIBILI / AVAILABLE GLASS COLOURS

01 - Trasparente
Transparent03 - Rosa sfumato
Pink Nuanced05 - Ambra sfumato
Amber nuanced06 - Verde sfumato
Green nuanced07 - Azzurro sfumato
Sky-blue nuanced08 - Fumè sfumato
Fume nuanced16 - Tabacco sfumato
Tobacco nuanced17 - Rubino sfumato
Ruby nuanced

FINITURA STRUTTURALE/ CORPO METALLICO A VISTA DISPONIBILE / AVAILABLE METALLIC FINISHES FOR METAL-BODY-STRUCTURE

Black Carbon
Black CarbonFrench gold
French goldChampagne
Champagne

FINITURA DISPONIBILE PER: PIASTRE, BINARI E DISASSATORI / FINISH AVAILABLE FOR: PLATES, TACKS AND SPACERS

Black Carbon
Black CarbonFrench gold
French goldChampagne
Champagne

CARATTERISTICHE TECNICHE / TECHNICAL FEATURES

MATERIALI: VETRO BOROSILICATO E ALLUMINIO / MATERIALS: BOROSILICATE GLASS AND ALUMINIUM

COMPATIBILE CON CASAMBI / COMPATIBLE WITH CASAMBI

DIMMERABILE A TAGLIO DI FASE / TRIAC DIMMABLE

LED (COB) E DRIVER INCLUSI / LED (COB) AND DRIVER INCLUDED

SCHEDA LED SOSTITUIBILE DA PROFESSIONISTA / LED BOARD REPLACEABLE BY PROFESSIONAL

I LUMEN INDICATI CORRISPONDONO ALL'INTENSITÀ LUMINOSA ALL'ORIGINE DELLA SCHEDA LED / LUMEN INDICATED CORRESPONDS TO THE LUMINOUS INTENSITY AT THE ORIGIN OF THE LED BOARD

DURATA DEL LED 50.000 ORE / LED LIFESPAN 50.000 HOURS

CAVO ELETTRICO COASSIALE A BASSA TENSIONE TRASPARENTE O NERO / COAXIAL LOW VOLTAGE ELECTRIC CABLE IN TRANSPARENT OR BLACK

SORGENTE LUMINOSA / LIGHTING SOURCE:

LED DISPONIBILE PER SOSPENSIONE 1613, LAMPADE DA TAVOLO E PIANTANA LU1615.1L / LEDS AVAILABLE FOR 1613, TABLE LAMPS AND FLOOR LAMP LU1615.1L

• LED 1x 9W - 27V - 350mA - CRI Typ 95 - 1.125 Lm - 125 Lm/W - 120° - 3 Step MacAdam - 2700K or 3000K

LED DISPONIBILE PER SOSPENSIONE GIG1613 E PIANTANA LUGIG1615.1L / LEDS AVAILABLE FOR HANGING LAMP GIG1613 AND FLOOR LAMP LUGIG1615.1L

• LED 1x 12W - 36V - 350mA - CRI Typ 95 - 1.500 Lm - 125 Lm/W - 120° - 3 Step MacAdam - 2700K or 3000K

ON DEMAND / OPTIONAL FEATURES

- PERSONALIZZAZIONE LUNGHEZZA DEL CAVO SU RICHIESTA / CUSTOMISED CABLE LENGTH ON REQUEST
- A RICHIESTA CON COMPONENTI UL / ON DEMAND WITH UL COMPONENTS
- DISPONIBILE SU RICHIESTA CON DRIVER DALI / AVAILABLE ON REQUEST WITH DALI DRIVER
- DALMA 1613 E GIG1613 DISPONIBILE CON SISTEMA UP E DOWN / DALMA 1613 AND GIG1613 AVAILABLE WITH UP AND DOWN SYSTEM



LU1615.1L

LAMPADA DA TERRA / FLOOR LAMP
 WITH DIMMER PUSH BUTTON

Glass 1 x Ø 17 cm - Cable 200 cm

1 x LED 9W DIMM

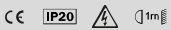

LUGIG1615.1L

LAMPADA DA TERRA / FLOOR LAMP
 WITH DIMMER PUSH BUTTON

Glass 1 x Ø 24 cm - Cable 200 cm

1 x LED 12W DIMM

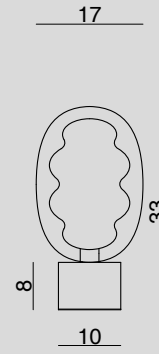
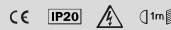

LU1610.1L

LAMPADA DA TAVOLO / TABLE LAMP
 WITH DIMMER PUSH BUTTON

Glass 1 x Ø 17 cm - Cable 200 cm

1 x LED 9W DIMM

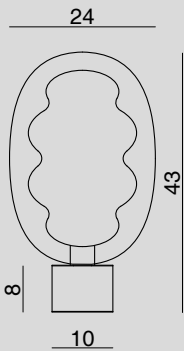
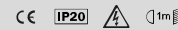

LUGIG1610.1L

LAMPADA DA TAVOLO / TABLE LAMP
 WITH DIMMER PUSH BUTTON

Glass 1 x Ø 24 cm - Cable 200 cm

1 x LED 9W DIMM

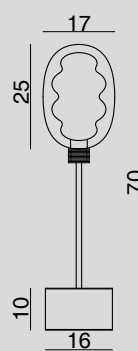
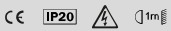

LU1614.1L

LAMPADA DA TAVOLO / TABLE LAMP
 WITH DIMMER PUSH BUTTON

Glass 1 x Ø 17 cm - Cable 200 cm

1 x LED 9W DIMM

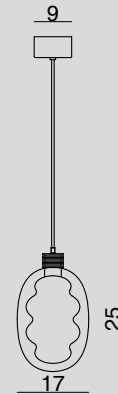
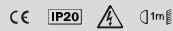

1613.1L

SOSPENSIONE A ROSONE / HANGING
 LAMP WITH CANOPY

Glass 1 x Ø 17 cm - Cable 200 cm

1 x LED 9W DIMM

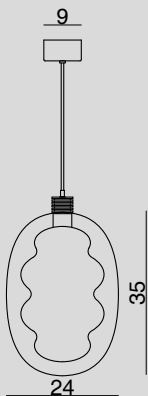
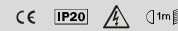

GIG1613.1L

SOSPENSIONE A ROSONE / HANGING
 LAMP WITH CANOPY

Glass 1 x Ø 24 cm - Cable 200 cm

1 x LED 12W DIMM

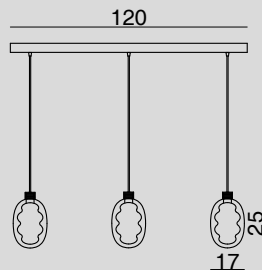
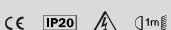

1617.120.3L

SOSPENSIONE A BINARIO / HANGING
 LAMP WITH TRACKS

Glass 3 x Ø 17 cm

3 x LED 9W DIMM

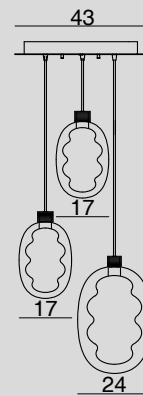
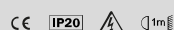

1619MX.43.3L

SOSPENSIONE A PIASTRA / HANGING
 LAMP WITH CEILING PLATE

Glass 3 x Ø 17-17-24 cm - Cable 200 cm

2 x LED 9W DIMM - 1 x LED 12W DIMM

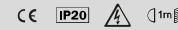



1292.37L

Glass: steel, bronze, gold, rose gold, black



ECLISSE®

DESIGN: PIETRO TUCCI (2014)



1299.9L
Glass: bronze, gold, black, steel



1293.1L
Glass: steel
Structure: chrome



3x **APS1291.1L**

Glass: gold, bronze, steel

Structure: chrome



S1290.1L
Glass: transparent (01)
Structure: chrome



COLORI, MATERIALI, FINITURE / CMF

COLORI VETRO DISPONIBILI / AVAILABLE GLASS COLOURS



01 - Trasparente
Transparent



03 - Rosa
Pink



05 - Ambra
Amber



06 - Verde
Green



07 - Azzurro
Sky-Blue



08 - Fumè
Fume



16 - Tabacco
Tobacco



17 - Rubino
Ruby

COLORI VETRO METALLIZZATO DISPONIBILI SOLO PER VETRI Ø14 cm / METALLIC GLASS COLOURS AVAILABLE ONLY FOR GLASSES Ø14 cm



Oro rosa
Rose gold



Oro
Gold



Bronzo
Bronze



Nero
Black



Acciaio
Steel

FINITURA STRUTTURA/ CORPO METALLICO A VISTA DISPONIBILE / AVAILABLE METALLIC FINISHES FOR METAL-BODY-STRUCTURE



Cromo
Chrome

FINITURA DISPONIBILE PER: PIASTRE, BINARI E DISASSATORI / FINISH AVAILABLE FOR: PLATES, TACKS AND SPACERS



Cromo
Chrome



Cromo spazzolato
Brushed chrome



Nero opaco
Matt black



Bianco opaco
Matt white

CARATTERISTICHE TECNICHE / TECHNICAL FEATURES

MATERIALI: VETRO BOROSILICATO E OTTONE / MATERIALS: BOROSILICATE GLASS AND BRASS

CAVO ELETTRICO TRASPARENTE, A RICHIESTA: MARRONE / ROSSO / TRANSPARENT ELECTRIC CABLE, ON DEMAND: BROWN / RED

SORGENTE LUMINOSA / LIGHTING SOURCE:

- G9 - 33W - 220V-240V
- LAMPADINA NON INCLUSA / BULB NOT INCLUDED

ON DEMAND / OPTIONAL FEATURES

- PERSONALIZZAZIONE LUNGHEZZA DEL CAVO SU RICHIESTA / CUSTOMISED CABLE LENGTH ON REQUEST
- A RICHIESTA CON COMPONENTI UL / ON DEMAND WITH UL COMPONENTS

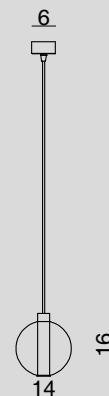
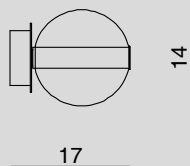
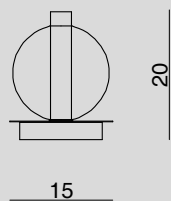

S1290.1L

LAMPADA DA TAVOLO / TABLE LAMP

Glass 1 x Ø 14 cm - Cable 200 cm

1 x G9 33 W

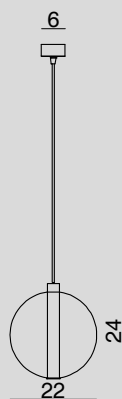
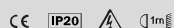

APS1291.1L

APPLIQUE / WALL LAMP

Glass 1 x Ø 14 cm

1 x G9 33 W

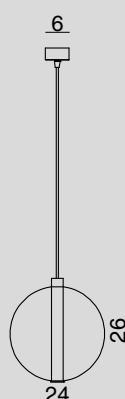
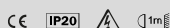

1293.1L

SOSPENSIONE A ROSONE / HANGING LAMP WITH CANOPY

Glass 1 x Ø 14 cm - Cable 150 cm

1 x G9 33 W

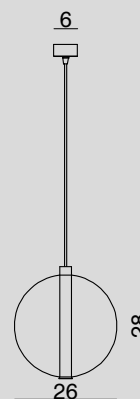
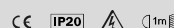

MED1293.1L

SOSPENSIONE A ROSONE / HANGING LAMP WITH CANOPY

Glass 1 x Ø 22 cm - Cable 150 cm

1 x G9 33 W

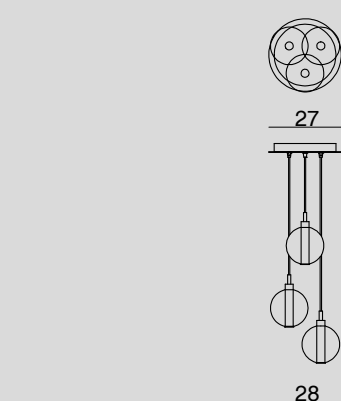
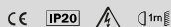

GIG1293.1L

SOSPENSIONE A ROSONE / HANGING LAMP WITH CANOPY

Glass 1 x Ø 24 cm - Cable 150 cm

1 x G9 33 W

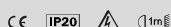

XXL1293.1L

SOSPENSIONE A ROSONE / HANGING LAMP WITH CANOPY

Glass 1 x Ø 26 cm - Cable 150 cm

1 x G9 33 W

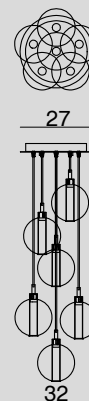
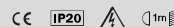

1299.3L

SOSPENSIONE A PIASTRA / HANGING LAMP WITH CEILING PLATE

Glass 3 x Ø 14 cm - Cable 150 cm

3 x G9 33 W

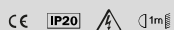

1299.6L

SOSPENSIONE A PIASTRA / HANGING LAMP WITH CEILING PLATE

Glass 6 x Ø 14 cm - Cable 150 cm

6 x G9 33 W

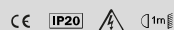

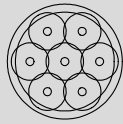

43

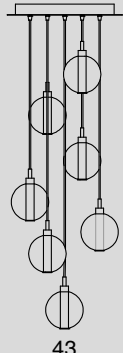

43

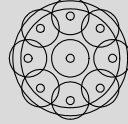

43

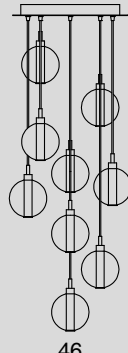

46

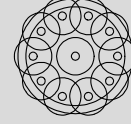

43

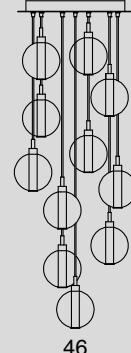

46

1299.7L

SOSPENSIONE A PIASTRA / HANGING LAMP WITH CEILING PLATE

Glass 7 x Ø 14 cm - Cable 150 cm

7 x G9 33 W

CE IP20 ⚠ 1m

1299.9L

SOSPENSIONE A PIASTRA / HANGING LAMP WITH CEILING PLATE

Glass 9 x Ø 14 cm - Cable 150 cm

9 x G9 33 W

CE IP20 ⚠ 1m

1299.11L

SOSPENSIONE A PIASTRA / HANGING LAMP WITH CEILING PLATE

Glass 11 x Ø 14 cm - Cable 150 cm

11 x G9 33 W

CE IP20 ⚠ 1m



27



28

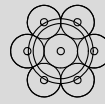

27



43

1292.3L

SOSPENSIONE A PIASTRA / HANGING LAMP WITH CEILING PLATE

Glass 3 x Ø 14 cm - Cable 150 cm

3 x G9 33 W

CE IP20 ⚠ 1m

1292.7L

SOSPENSIONE A PIASTRA / HANGING LAMP WITH CEILING PLATE

Glass 7 x Ø 14 cm - Cable 150 cm

7 x G9 33 W

CE IP20 ⚠ 1m

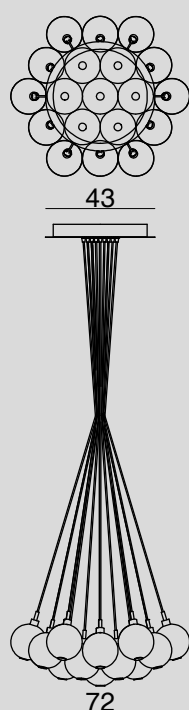

1292.19L

SOSPENSIONE A PIASTRA / HANGING LAMP
WITH CEILING PLATE

Glass 19 x Ø 14 cm - Cable 250 cm

19 x G9 33 W

CE IP20  1m

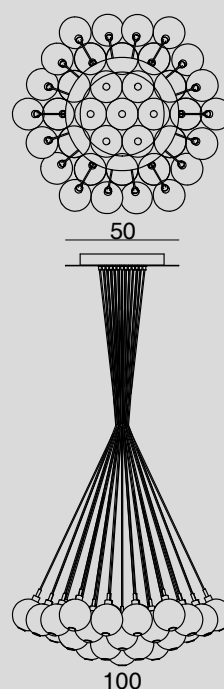

1292.37L

SOSPENSIONE A PIASTRA / HANGING LAMP
WITH CEILING PLATE

Glass 37 x Ø 14 cm - Cable 250 cm

37 x G9 33 W

CE IP20  1m

DETTAGLI PRODOTTO
PRODUCT DETAILS





Plate **P40X130**

2x **1563**

Glass: *fume (08), amber (05)*

3x **GIG1563**

Glass: *amber (05), black, bronze*

2x **XXL1563**

Glass: *black, bronze*

ECLISSE[®] MAX

DESIGN: PIETRO TUCCI (2021)





Plate **P50**

2x **1563**

Glass: *fume (08), amber (05)*

2x **GIG1563**

Glass: *bronze*

1x **XXL1563**

Glass: *black*



2x 1563.1L
Glass: amber (05)
Canopy: satin black nickel



1563
GIG1563
XXL1563
Glass: amber (05), transparent, bronze, black



2x XXL1563.1L
Glass: bronze
Canopy: satin black nickel



COLORI, MATERIALI, FINITURE / CMF

COLORI VETRO DISPONIBILI / AVAILABLE GLASS COLOURS



01 - Trasparente
Transparent



03 - Rosa
Pink



05 - Ambra
Amber



06 - Verde
Green



07 - Azzurro
Sky-Blue



08 - Fumè
Fume



16 - Tabacco
Tobacco



17 - Rubino
Ruby

COLORI VETRO METALLIZZATO DISPONIBILI / METALLIC GLASS COLOURS AVAILABLE



Bronzo
Bronze



Nero
Black



Acciaio
Steel

FINITURA STRUTTURA/ CORPO METALLICO A VISTA DISPONIBILE / AVAILABLE METALLIC FINISHES FOR METAL-BODY-STRUCTURE



Cromo
Chrome



Cromo spazzolato
Brushed chrome



Oro satinato
Satin gold
(on request)



Nichel nero satinato
Satin black nickel
(on request)



Nero opaco
Matt black



Oro rosa satinato
Satin rose gold
(on request)



Bianco opaco
Matt white

FINITURA DISPONIBILE PER: PIASTRE, BINARI E DISASSATORI / FINISH AVAILABLE FOR: PLATES, TRACKS AND SPACERS



Cromo
Chrome



Cromo spazzolato
Brushed chrome



Nero opaco
Matt black



Bianco opaco
Matt white

CARATTERISTICHE TECNICHE / TECHNICAL FEATURES

MATERIALI: VETRO BOROSILICATO E ALLUMINIO / MATERIALS: BOROSILICATE GLASS AND ALUMINIUM

COMPATIBILE CON CASAMBI / COMPATIBLE WITH CASAMBI

DIMMERABILE A TAGLIO DI FASE / TRIAC DIMMABLE

LED (COB) E DRIVER INCLUSI / LED (COB) AND DRIVER INCLUDED

SCHEDA LED SOSTITUIBILE DA PROFESSIONISTA / LED BOARD REPLACEABLE BY PROFESSIONAL

I LUMEN INDICATI CORRISPONDONO ALL'INTENSITÀ LUMINOSA ALL'ORIGINE DELLA SCHEDA LED / LUMEN INDICATED CORRESPONDS TO THE LUMINOUS INTENSITY AT THE ORIGIN OF THE LED BOARD

DURATA DEL LED 50.000 ORE / LED LIFESPAN 50.000 HOURS

CAVO ELETTRICO COASSIALE A BASSA TENSIONE TRASPARENTE O NERO / COAXIAL LOW VOLTAGE ELECTRIC CABLE IN TRANSPARENT OR BLACK

SORGENTE LUMINOSA / LIGHTING SOURCE:

LED DISPONIBILE PER ECLISSE MAX / LEDS AVAILABLE FOR ECLISSE MAX

- LED 1x 6W - 11,2V-12,8V - 500mA - CRI Typ 95 - 866 Lm - 144 Lm/W - 180° - 3 Step MacAdam - 2700K or 3000K

ON DEMAND / OPTIONAL FEATURES

- PERSONALIZZAZIONE LUNGHEZZA DEL CAVO SU RICHIESTA / CUSTOMISED CABLE LENGTH ON REQUEST
- A RICHIESTA CON COMPONENTI UL / ON DEMAND WITH UL COMPONENTS
- DISPONIBILE SU RICHIESTA CON DRIVER DALI / AVAILABLE ON REQUEST WITH DALI DRIVER

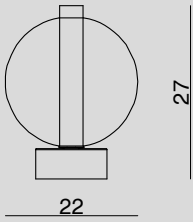

LU1560.1L

LAMPADA DA TAVOLO / TABLE LAMP

Glass 1 x Ø 22 cm - Cable 200 cm

1 x LED 6 W DIMM

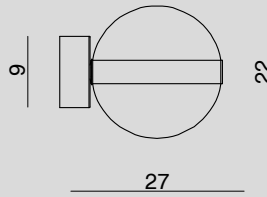
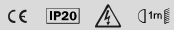

AP1561.1L

APPLIQUE / WALL LAMP

Glass 1 x Ø 22 cm

1 x LED 6 W DIMM

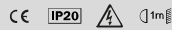

1563.1L

SOSPENSIONE A ROSONE / HANGING LAMP WITH CANOPY

Glass 1 x Ø 22 cm - Cable 200 cm

1 x LED 6 W DIMM

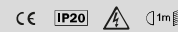

GIG1563.1L

SOSPENSIONE A ROSONE / HANGING LAMP WITH CANOPY

Glass 1 x Ø 24 cm - Cable 200 cm

1 x LED 6 W DIMM

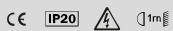

XXL1563.1L

SOSPENSIONE A ROSONE / HANGING LAMP WITH CANOPY

Glass 1 x Ø 26 cm - Cable 200 cm

1 x LED 6 W DIMM

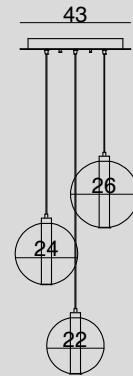
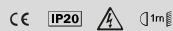

1569MX.43.3L

SOSPENSIONE A PIASTRA / HANGING LAMP WITH CEILING PLATE

Glass 3 x Ø 22-24-26 cm - Cable 200 cm

3 x LED 6 W DIMM

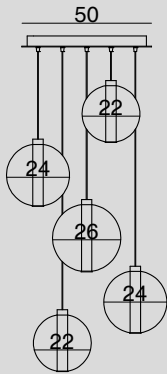
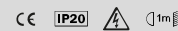

1569MX.50.5L

SOSPENSIONE A PIASTRA / HANGING LAMP WITH CEILING PLATE

Glass 5 x Ø 22-24-26 cm - Cable 200 cm

5 x LED 6 W DIMM

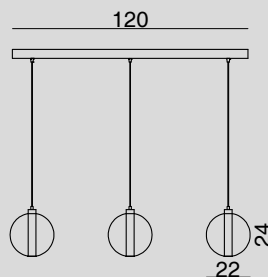
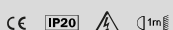

1567.120.3L

SOSPENSIONE A BINARIO / HANGING LAMP WITH TRACKS

Glass 3 x Ø 22 cm - Cable 200 cm

3 x LED 6 W DIMM

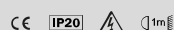

3x **XXL1543**
Glass: *amber (05)*
Structure: *chrome*





GEO[©]

DESIGN: PIETRO TUCCI (2022)

GEO È UNA LAMPADA A SOSPENSIONE IN VETRO SOFFIATO PRODOTTA A MANO IN ITALIA DA CANGINI E TUCCI. LA LAMPADA È MOLTO SEMPLICE MA ESTREMAMENTE ELEGANTE. IL CORPO IN VETRO È UNA SFERA CARATTERIZZATA DA UNA LEGGERA SCHIACCIATURA SUI POLI. LA FORMA CHE NE RISULTA È UN ELLISSOIDE, UN SOLIDO DI FORMA ELLITTICA, PERFETTO PER CHI CERCA UNA LAMPADA DECORATIVA MA ALLO STESSO TEMPO MOLTO MINIMAL E PULITA. LA LAMPADA VIENE ILLUMINATA DA UN MODULO LED POSIZIONATO ALL'APICE DEL CORPO IN VETRO. IL LED AD ALTA POTENZA GARANTISCE QUANTITÀ E QUALITÀ ILLUMINOTECNICHE ELEVATISSIME E IL GIOCO DI LUCI ED OMBRE SULLE SUPERFICI IN VETRO SONO DAVVERO UNICI.

GEO IS A BLOWN GLASS PENDANT LAMP HANDMADE IN ITALY BY CANGINI AND TUCCI. THE LAMP IS VERY SIMPLE BUT EXTREMELY ELEGANT. THE GLASS BODY IS A SPHERE CHARACTERIZED BY A SLIGHT FLATTENING AT THE POLES. THE RESULTING SHAPE IS AN ELLIPSOID PERFECT FOR THOSE LOOKING FOR A DECORATIVE LAMP BUT AT THE SAME TIME VERY MINIMAL AND CLEAN. THE LAMP IS ILLUMINATED BY AN LED MODULE POSITIONED AT THE APEX OF THE GLASS BODY. THE HIGH-POWER LED GUARANTEES VERY HIGH LIGHTING QUANTITY AND QUALITY AND THE PLAY OF LIGHT AND SHADOW ON THE GLASS SURFACES ARE TRULY UNIQUE.



1543.1L
Glass: tobacco (16)
Structure: chrome





Track **AUF150**

3x **XXL1543**

Glass: *amber (05)*

Structure: *chrome*



1x 1543
Glass: transparent

1x GIG1543
Glass: transparent

1x XXL1543
Glass: transparent



COLORI, MATERIALI, FINITURE / CMF

COLORI VETRO DISPONIBILI / AVAILABLE GLASS COLOURS



01 - Trasparente
Transparent



03 - Rosa
Pink



05 - Ambra
Amber



06 - Verde
Green



07 - Azzurro
Sky-Blue



08 - Fumè
Fume



16 - Tabacco
Tobacco



17 - Rubino
Ruby

FINITURA STRUTTURA/ CORPO METALLICO A VISTA DISPONIBILE / AVAILABLE METALLIC FINISHES FOR METAL-BODY-STRUCTURE



Cromo
Chrome



Cromo spazzolato
Brushed chrome



Oro satinato
Satin gold
(on request)



Nichel nero satinato
Satin black nickel
(on request)



Nero opaco
Matt black



Oro rosa satinato
Satin rose gold
(on request)



Bianco opaco
Matt white

FINITURA DISPONIBILE PER: PIASTRE, BINARI E DISASSATORI / FINISH AVAILABLE FOR: PLATES, TRACKS AND SPACERS



Cromo
Chrome



Cromo spazzolato
Brushed chrome



Nero opaco
Matt black



Bianco opaco
Matt white

CARATTERISTICHE TECNICHE / TECHNICAL FEATURES

MATERIALI: VETRO BOROSILICATO E ALLUMINIO / MATERIALS: BOROSILICATE GLASS AND ALUMINIUM

COMPATIBILE CON CASAMBI / COMPATIBLE WITH CASAMBI

DIMMERABILE A TAGLIO DI FASE / TRIAC DIMMABLE

LED (COB) E DRIVER INCLUSI / LED (COB) AND DRIVER INCLUDED

SCHEDA LED SOSTITUIBILE DA PROFESSIONISTA / LED BOARD REPLACEABLE BY PROFESSIONAL

I LUMEN INDICATI CORRISPONDONO ALL'INTENSITÀ LUMINOSA ALL'ORIGINE DELLA SCHEDA LED / LUMEN INDICATED CORRESPONDS TO THE LUMINOUS INTENSITY AT THE ORIGIN OF THE LED BOARD

DURATA DEL LED 50.000 ORE / LED LIFESPAN 50.000 HOURS

CAVO ELETTRICO COASSIALE A BASSA TENSIONE TRASPARENTE O NERO / COAXIAL LOW VOLTAGE ELECTRIC CABLE IN TRANSPARENT OR BLACK

SORGENTE LUMINOSA / LIGHTING SOURCE:

LED DISPONIBILE PER GEO / LEDS AVAILABLE FOR GEO

- LED 1x 6W - 11,2V-12,8V - 500mA - CRI Typ 95 - 866 Lm - 144 Lm/W - 180° - 3 Step MacAdam - 2700K or 3000K

ON DEMAND / OPTIONAL FEATURES

- **PERSONALIZZAZIONE LUNGHEZZA DEL CAVO SU RICHIESTA / CUSTOMISED CABLE LENGTH ON REQUEST**
- **A RICHIESTA CON COMPONENTI UL / ON DEMAND WITH UL COMPONENTS**
- **DISPONIBILE SU RICHIESTA CON DRIVER DALI / AVAILABLE ON REQUEST WITH DALI DRIVER**
- **A RICHIESTA: ARTICOLI 1543, GIG1543 E XXL1543 CON LED DA 8,4W (1202 Lm) / ON DEMAND: PRODUCTS 1543, GIG1543 AND XXL1543 WITH 8,4W LED (1202 Lm)**
- **GEO GIG1543 E XXL1543 DISPONIBILE CON SISTEMA UP E DOWN / GEO GIG1543 AND XXL1543 AVAILABLE WITH UP AND DOWN SYSTEM**



1543.1L

SOSPENSIONE A ROSONE / HANGING LAMP WITH CANOPY

Glass 1 x Ø 26 cm - Cable 200 cm

1 x LED 6 W DIMM

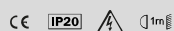

GIG1543.1L

SOSPENSIONE A ROSONE / HANGING LAMP WITH CANOPY

Glass 1 x Ø 30 cm - Cable 200 cm

1 x LED 6 W DIMM

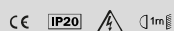

XXL1543.1L

SOSPENSIONE A ROSONE / HANGING LAMP WITH CANOPY

Glass 1 x Ø 34 cm - Cable 200 cm

1 x LED 6 W DIMM

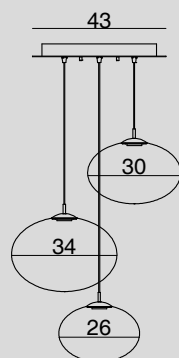
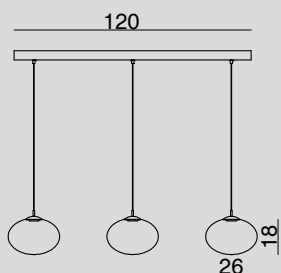
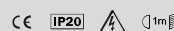

1547.120.3L

SOSPENSIONE A BINARIO / HANGING LAMP WITH TRACKS

Glass 3 x Ø 26 cm - Cable 200 cm

3 x LED 6 W DIMM

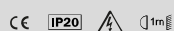

1549MX.43.3L

SOSPENSIONE A PIASTRA / HANGING LAMP WITH CEILING PLATE

Glass 3 x Ø 26-30-34 cm - Cable 200 cm

3 x LED 6 W DIMM

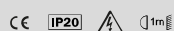

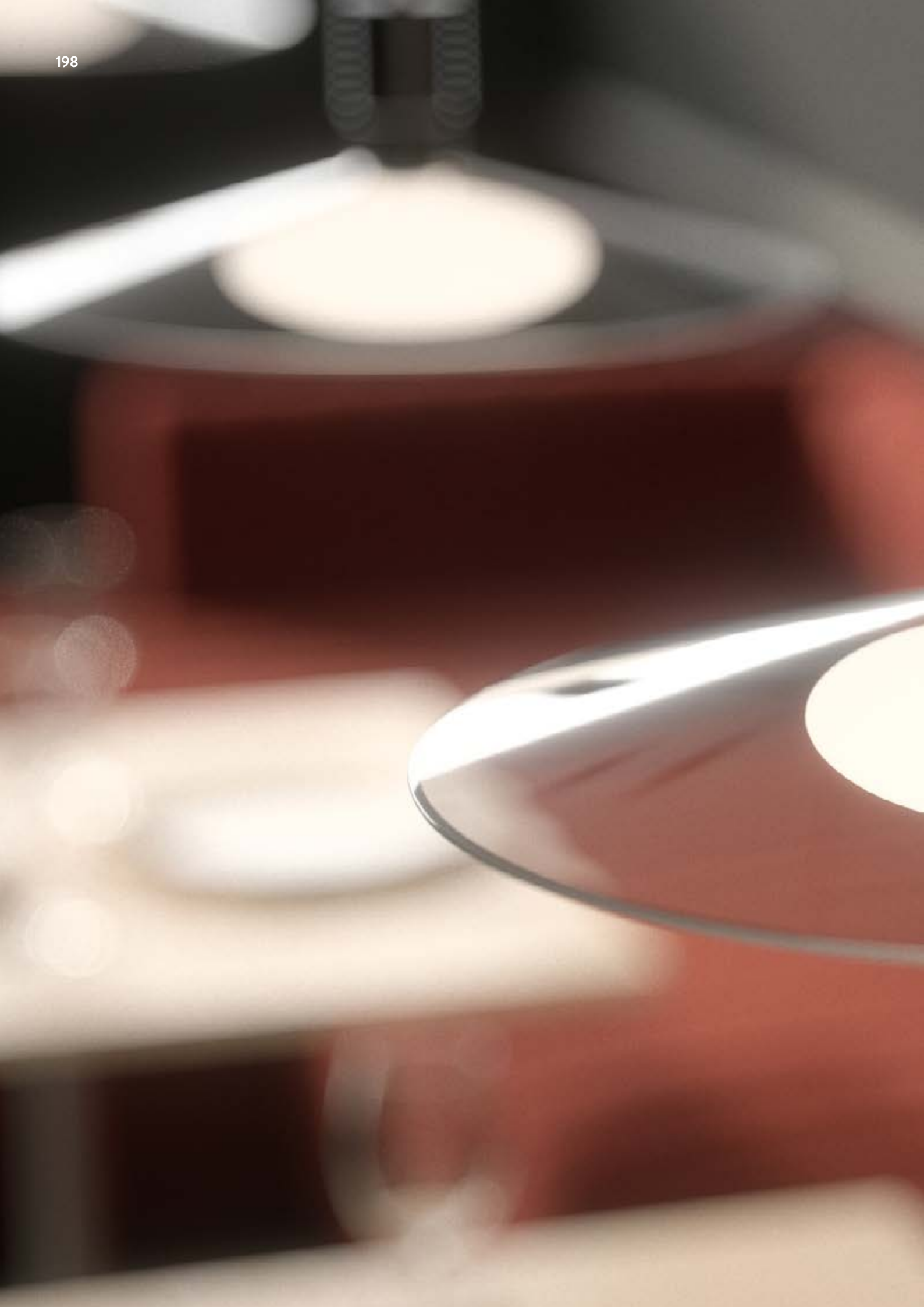



HYDRA[©] [®]

DESIGN: PIETRO TUCCI (2024)

LA COLLEZIONE HYDRA NASCE DALL'IDEA DI RIPORTARE LA LUMINIOSITÀ DI UNA STELLA ALL'INTERNO DI UNA LAMPADA. DA QUI IL NOME HYDRA, IN LATINO, CHE CONTRADDISTINGUE PROPRIO LA LUNGA E LUMINOSA COSTELLAZIONE DELL'IDRA.

LA NUOVA LAMPADA È COSTITUITA DA UN DISCO CONICO ILLUMINATO AL CENTRO CHE RISPLENDE SFRUTTANDO AL MASSIMO LE ALTE QUALITÀ DELLA SORGENTE LED. IL BULBO CENTRALE IN VETRO SATINATO RIFLETTE LA LUCE SUL PARALUME IN VETRO LAVORATO A MANO GENERANDO UN FASCIO LUMINOSO UNIFORME. LA COLLEZIONE, DAL DESIGN MINIMAL MA RICERCATO, OFFRE UNA TOTALE LIBERTÀ COMPOSITIVA ADATTANDOSI A QUALSIASI TIPO DI AMBIENTE, COME UNA STELLA, SENZA CONFINI DI SPAZIO E TEMPO.

HYDRA È DECLINATA NELLE VERSIONI A SOSPENSIONE, APPLIQUE E PLAFONIERA, PUÒ ESSERE REALIZZATA IN TRE DIMENSIONI E IN DIVERSE COLORAZIONI, CREA UN'ATMOSFERA ALTAMENTE DECORATIVA RISPLENDENDO E PORTANDO LA LUCE NEL BUIO.

THE HYDRA COLLECTION WAS DESIGNED WITH THE IDEA OF BRINGING THE LUMINOSITY OF A STAR INTO A LAMP. THIS GAVE RISE TO THE NAME IN LATIN FOR THE LONG, LUMINOUS CONSTELLATION HYDRA.

THE NEW LAMP TAKES THE SHAPE OF A CONICALLY ILLUMINATED DISC IN THE CENTRE THAT SHINES BY MAKING THE MOST OF THE HIGH QUALITY OF THE LED SOURCE. THE CENTRAL FROSTED GLASS BULB REFLECTS THE LIGHT ONTO THE HANDCRAFTED GLASS SHADE, GENERATING A UNIFORM LIGHT BEAM.

THE COLLECTION, WITH ITS MINIMAL YET REFINED DESIGN, OFFERS TOTAL FREEDOM OF COMPOSITION, ADAPTING TO ANY TYPE OF ENVIRONMENT, LIKE A STAR, WITH NO BOUNDARIES OF SPACE OR TIME.

HYDRA IS AVAILABLE IN PENDANT, WALL AND CEILING VERSIONS, CAN BE MADE IN THREE SIZES AND IN DIFFERENT COLOURS, AND CREATES A HIGHLY DECORATIVE ATMOSPHERE BY SHINING AND BRINGING LIGHT INTO THE DARK.

XXL1633.1L

Glass: transparent

Structure: black carbon





XXL1633.1L
Glass: green (06)
Structure: black carbon



XXL1633.1L

Glass: transparent

Structure: black carbon



2x GIG1633.1L
Glass: transparent
Structure: black carbon



2x AP1631.1L
Glass: tobacco (16)
Structure: champagne



2x 1636.1L
Glass: green (06), sky-blue (07)
Structure: black carbon



COLORI, MATERIALI, FINITURE / CMF

COLORI VETRO DISPONIBILI / AVAILABLE GLASS COLOURS



01 - Trasparente
Transparent



03 - Rosa
Pink



05 - Ambra
Amber



06 - Verde
Green



07 - Azzurro
Sky-Blue



08 - Fumè
Fume



16 - Tabacco
Tobacco



17 - Rubino
Ruby

FINITURA STRUTTURA/ CORPO METALLICO A VISTA DISPONIBILE / AVAILABLE METALLIC FINISHES FOR METAL-BODY-STRUCTURE



Black Carbon
Black Carbon



French gold
French gold



Champagne
Champagne

FINITURA DISPONIBILE PER: PIASTRE, BINARI E DISASSATORI / FINISH AVAILABLE FOR: PLATES, TACKS AND SPACERS



Black Carbon
Black Carbon



French gold
French gold



Champagne
Champagne

CARATTERISTICHE TECNICHE / TECHNICAL FEATURES

MATERIALI: VETRO BOROSILICATO E ALLUMINIO / MATERIALS: BOROSILICATE GLASS AND ALUMINIUM

COMPATIBILE CON CASAMBI / COMPATIBLE WITH CASAMBI

DIMMERABILE A TAGLIO DI FASE / TRIAC DIMMABLE

LED (COB) E DRIVER INCLUSI / LED (COB) AND DRIVER INCLUDED

SCHEDA LED SOSTITUIBILE DA PROFESSIONISTA / LED BOARD REPLACEABLE BY PROFESSIONAL

I LUMEN INDICATI CORRISPONDONO ALL'INTENSITÀ LUMINOSA ALL'ORIGINE DELLA SCHEDA LED / LUMEN INDICATED CORRESPONDS TO THE LUMINOUS INTENSITY AT THE ORIGIN OF THE LED BOARD

DURATA DEL LED 50.000 ORE / LED LIFESPAN 50.000 HOURS

CAVO ELETTRICO NEP NERO O IN SILICONE TRASPARENTE A RICHIESTA: MARRONE / ROSSO / BLACK FEP OR TRANSPARENT SILICONE ELECTRIC CABLE, ON DEMAND: BROWN / RED

SORGENTE LUMINOSA / LIGHTING SOURCE:

LED DISPONIBILE PER SOSPENSIONE 1633, APPLIQUE AP1631.1L, PLAFONIERA 1636.1L / LEDS AVAILABLE FOR 1633, WALL LAMP AP1631.1L, CEILING LAMP 1636.1L

• LED 1x 9W - 27V - 350mA - CRI Typ 95 - 1.125 Lm - 125 Lm/W - 120° - 3 Step MacAdam - 2700K-3000K

LED DISPONIBILE PER SOSPENSIONE GIG1633, APPLIQUE APGIG1631.1L, PLAFONIERA GIG1636.1L / LEDS AVAILABLE FOR GIG 1633, WALL LAMP APGIG1631.1L, CEILING LAMP GIG1636.1L

• LED 1x 12W - 36V - 350mA - CRI Typ 95 - 1.500 Lm - 125 Lm/W - 120° - 3 Step MacAdam - 2700K or 3000K

LED DISPONIBILE PER SOSPENSIONE XXL1633 / LEDS AVAILABLE FOR XXL1633

• LED 1x 15W - 45V - 350mA - CRI Typ 95 - 1.875 Lm - 125 Lm/W - 120° - 3 Step MacAdam - 2700K or 3000K

ON DEMAND / OPTIONAL FEATURES

- PERSONALIZZAZIONE LUNGHEZZA DEL CAVO SU RICHIESTA / CUSTOMISED CABLE LENGTH ON REQUEST
- A RICHIESTA CON COMPONENTI UL / ON DEMAND WITH UL COMPONENTS
- DISPONIBILE SU RICHIESTA CON DRIVER DALI / AVAILABLE ON REQUEST WITH DALI DRIVER
- HYDRA GIG1633 DISPONIBILE CON SISTEMA UP E DOWN / HYDRA GIG1633 AVAILABLE WITH UP AND DOWN SYSTEM

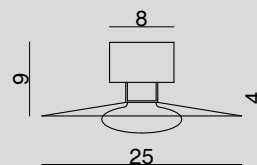
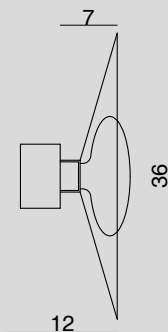
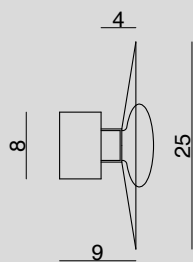

AP1631.1L

APPLIQUE / WALL LAMP

Glass 1 x Ø 25 cm

1 x LED 9W DIMM

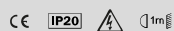

APGIG1631.1L

APPLIQUE / WALL LAMP

Glass 1 x Ø 36 cm

1 x LED 12W DIMM

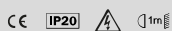

1636.1L

PLAFONIERA / CEILING LAMP

Glass 1 x Ø 25 cm

1 x LED 9W DIMM

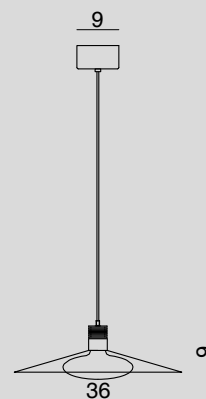
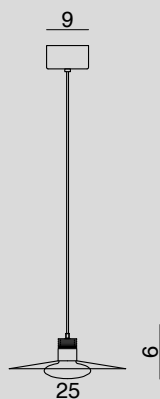
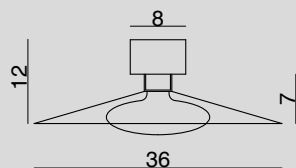
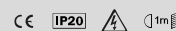

GIG1636.1L

PLAFONIERA / CEILING LAMP

Glass 1 x Ø 36 cm

1 x LED 12W DIMM

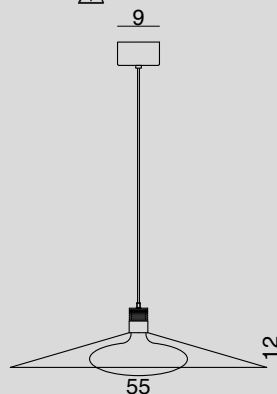
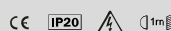

1633.1L

SOSPENSIONE A ROSONE / HANGING LAMP WITH CANOPY

Glass 1 x Ø 25 cm - Cable 200 cm

1 x LED 9W DIMM

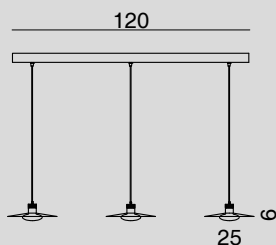
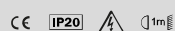

GIG1633.1L

SOSPENSIONE A ROSONE / HANGING LAMP WITH CANOPY

Glass 1 x Ø 36 cm - Cable 200 cm

1 x LED 12W DIMM

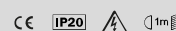

XXL1633.1L

SOSPENSIONE A ROSONE / HANGING LAMP WITH CANOPY

Glass 1 x Ø 55 cm - Cable 200 cm

1 x LED 15W DIMM

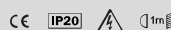

1637.120.3L

SOSPENSIONE A BINARIO / HANGING LAMP WITH TRACKS

Glass 3 x Ø 25 cm - Cable 200 cm

3 x LED 9W DIMM

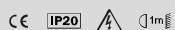



2x 1593.1L

Glass: transparent - ruby (17) drop

Glass: transparent - amber (05) drop

Structure: satin black nickel



LA STILLA^{© ®}

DESIGN:  MARCANTONIO[®] (2023)



“ALL’ORIGINE DELLA VITA C’È L’ACQUA. LA LUCE E L’ACQUA SONO DUE ELEMENTI FONDAMENTALI DEL MONDO NATURALE. MI VENGONO IN MENTE I RIFLESSI DI LUCE SULL’ACQUA IN MOVIMENTO DI UN RUSCELLO CHE NUTRE LE RADICI DEGLI ALBERI, O LA LUCE CHE PENETRA NELLE ACQUE DI UN OCEANO, O UNA GOCCIA CHE BRILLA ALL’INTERNO DI UNA CAVITÀ NELLA ROCCIA. SE L’ACQUA CI DISSETA, LA LUCE CI DÀ GIOIA E CALORE. LA STILLA È UN TRIBUTO A QUELL’ATTIMO, QUEL MOMENTO IN CUI LA NATURA, SILENZIOSAMENTE, FA IL SUO CORSO.”
MARCANTONIO

“WATER IS THE SOURCE OF LIFE. LIGHT AND WATER ARE TWO FUNDAMENTAL ELEMENTS OF THE NATURAL WORLD. I THINK OF LIGHT REFLECTED IN THE MOVING WATER OF A STREAM THAT FEEDS THE ROOTS OF TREES, OR THE LIGHT THAT PENETRATES THE DEPTHS IN WATERS OF AN OCEAN, OR A DROP OF WATER SPARKLING IN A CAVITY IN THE ROCK. IF WATER QUENCHES OUR THIRST, LIGHT GIVES US WARMTH AND JOY. LA STILLA IS A HOMAGE TO THAT MOMENT, THE MOMENT WHEN NATURE TAKES ITS OWN COURSE, IN SILENCE.”
MARCANTONIO



1x **1593.1L**
Glass: amber (05)
Structure: satin black nickel

1x **1593.1L**
Glass: fume (08)
Structure: satin black nickel

1x **GIG1593.1L**
Glass: tobacco (16)
Structure: satin black nickel

1x **GIG1593.1L**
Glass: sky-blue (07)
Structure: satin black nickel

1x **XXL1593.1L**
Glass: green (06)
Structure: satin black nickel



2x 1596.26.1L
Glass: fume (08)
Structure: satin black nickel

3x AP1591.20.1L
Glass: fume (08)
Structure: satin black nickel



1593.1L

Glass: transparent - ruby (17) drop
Structure: satin black nickel

XXL1593.1L

Glass: transparent - fume (08) drop
Structure: satin black nickel

GIG1593.1L

Glass: transparent - green (06) drop
Structure: satin black nickel



COLORI, MATERIALI, FINITURE / CMF

COLORI VETRO DISPONIBILI / AVAILABLE GLASS COLOURS



FINITURA STRUTTURALE/ CORPO METALLICO A VISTA DISPONIBILE / AVAILABLE METALLIC FINISHES FOR METAL-BODY-STRUCTURE

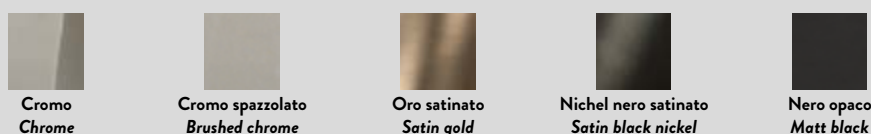

FINITURA DISPONIBILE PER: PIASTRE, BINARI E DISASSATORI / FINISH AVAILABLE FOR: PLATES, TRACKS AND SPACERS



CARATTERISTICHE TECNICHE / TECHNICAL FEATURES

MATERIALI: VETRO BOROSILICATO E ALLUMINIO / MATERIALS: BOROSILICATE GLASS AND ALUMINIUM

COMPATIBILE CON CASAMBI / COMPATIBLE WITH CASAMBI

DIMMERABILE A TAGLIO DI FASE / TRIAC DIMMABLE

LED (COB) E DRIVER INCLUSI / LED (COB) AND DRIVER INCLUDED

SCHEDA LED SOSTITUIBILE DA PROFESSIONISTA / LED BOARD REPLACEABLE BY PROFESSIONAL

I LUMEN INDICATI CORRISPONDONO ALL'INTENSITÀ LUMINOSA ALL'ORIGINE DELLA SCHEDA LED / LUMEN INDICATED CORRESPONDS TO THE LUMINOUS INTENSITY AT THE ORIGIN OF THE LED BOARD

DURATA DEL LED 50.000 ORE / LED LIFESPAN 50.000 HOURS

CAVO ELETTRICO GOMMA NERO O TRASPARENTE IN SILICONE / ELECTRIC CABLE BLACK GUM OR SILICONE TRANSPARENT

SORGENTE LUMINOSA / LIGHTING SOURCE:

LED DISPONIBILE PER LAMPADA A SOSPENSIONE 1593 E APPLIQUE AP1591.1L / LEDS AVAILABLE FOR HANGING LAMP 1593 AND WALL LAMP AP1591.1L

• LED 1x 8,4W - 22,4V-24,8V - 350mA - CRI Typ 95 - 1.202 Lm - 144 Lm/W - 180° - 3 Step MacAdam - 2700K or 3000K

LED DISPONIBILE PER LAMPADA A SOSPENSIONE GIG1593, XXL1593 E PLAFONIERE 1596.26.1L, 1596.30.1L / LEDS AVAILABLE FOR HANGING LAMP GIG1593, XXL1593 AND CEILING LAMP 1596.26.1L, 1596.30.1L

• LED 1x 12,8W - 32V-40V - 350mA - CRI Typ 95 - 1.615 Lm - 126 Lm/W - 180° - 3 Step MacAdam - 2700K or 3000K

ON DEMAND / OPTIONAL FEATURES

- **PERSONALIZZAZIONE LUNGHEZZA DEL CAVO SU RICHIESTA / CUSTOMISED CABLE LENGTH ON REQUEST**
- **A RICHIESTA CON COMPONENTI UL / ON DEMAND WITH UL COMPONENTS**
- **DISPONIBILE SU RICHIESTA CON DRIVER DALI / AVAILABLE ON REQUEST WITH DALI DRIVER**
- **POSSIBILITÀ DI PERSONALIZZARE IL DETTAGLIO INTERNO (GOCCIA) CON COLORE DIVERSO DAL VETRO ESTERNO / INNER DETAIL (DROP) CAN BE CUSTOMISED IN A DIFFERENT COLOUR FROM THE OUTER GLASS**

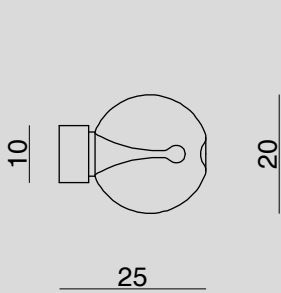

AP1591.20.1L
 APPLIQUE / WALL LAMP
 Glass 1 x Ø 20 cm
 1 x LED 8,4 W DIMM

CE IP20 ⚡ 1m

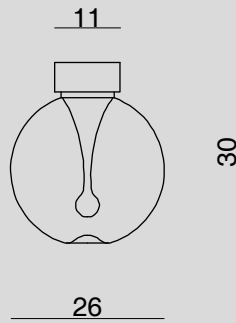

1596.26.1L
 PLAFONIERA / CEILING LAMP
 Glass 1 x Ø 26 cm
 1 x LED 12,8 W DIMM

CE IP20 ⚡ 1m

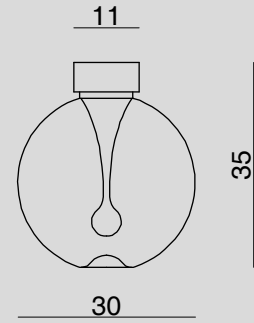

1596.30.1L
 PLAFONIERA / CEILING LAMP
 Glass 1 x Ø 30 cm
 1 x LED 12,8 W DIMM

CE IP20 ⚡ 1m



1593.1L
 SOSPENSIONE A ROSONE / HANGING LAMP WITH CANOPY
 Glass 1 x Ø 20 cm - Cable 200 cm
 1 x LED 8,4 W DIMM

CE IP20 ⚡ 1m

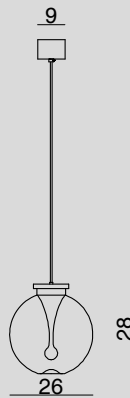

GIG1593.1L
 SOSPENSIONE A ROSONE / HANGING LAMP WITH CANOPY
 Glass 1 x Ø 26 cm - Cable 200 cm
 1 x LED 12,8 W DIMM

CE IP20 ⚡ 1m

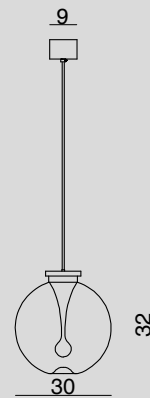

XXL1593.1L
 SOSPENSIONE A ROSONE / HANGING LAMP WITH CANOPY
 Glass 1 x Ø 30 cm - Cable 200 cm
 1 x LED 12,8 W DIMM

CE IP20 ⚡ 1m

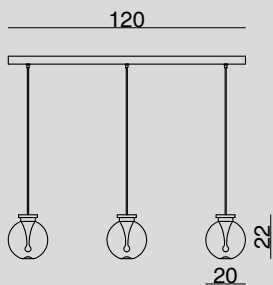

1597.120.3L
 SOSPENSIONE A BINARIO / HANGING LAMP WITH TRACKS
 Glass 3 x Ø 20 cm - Cable 200 cm
 3 x LED 8,4 W DIMM

CE IP20 ⚡ 1m

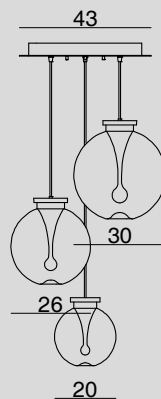

1599MX.43.3L
 SOSPENSIONE A PIASTRA / HANGING LAMP WITH CEILING PLATE
 Glass 3 x Ø 20-26-30 cm - Cable 200 cm
 1 x LED 8,4 W DIMM - 2 x LED 12,8 W DIMM

CE IP20 ⚡ 1m





REGULA[©]

DESIGN: PIETRO TUCCI
WITH THE COLLABORATION OF ALBERTO MANZONI (2024)



ELEGANT, MINIMAL AND VERY POWERFUL, THESE ARE THE THREE CHARACTERISTICS THAT DESCRIBE THE NEW REGULA FAMILY OF LAMPS. THE COLLECTION INCLUDES TWO WALL LAMPS AND ONE HANGING LAMP. THE GLASS IS THE SAME ONE WE HAVE ALWAYS USED, BOROSILICATE, THIS TIME WORKED IN A SQUARE TUBULAR SECTION. SURPRISING IS THE QUALITY OF LIGHT EXPRESSED BY THE LEDS MADE IN ITALY ESPECIALLY FOR THIS LINE. THE WALL LIGHTS ARE MOUNTED ON THE WALL WITH A 'CLIP-ON' SYSTEM TO AVOID UNSIGHTLY FASTENING ELEMENTS. NOVELTY AND INNOVATION ARE PROVIDED BY A MAGNET THAT ALLOWS THE GLASS TO BE EASILY REMOVED FOR CLEANING. THE SUSPENSION HAS A FUNCTIONAL 'JACK' COUPLING THAT IS EASY TO CONNECT TO THE POWER SUPPLY. THE PRACTICAL SKILL BEHIND REGULA WAS TO SIMPLIFY THE DESIGN BY TAKING OUT THE NEEDLESS AND MAKING ONLY WHAT IS NECESSARY TO SHINE.

ELEGANTE, MINIMAL E MOLTO POTENTE, QUESTE SONO LE TRE CARATTERISTICHE CHE DESCRIVONO LA NUOVA FAMIGLIA DI LAMPADIE. LA COLLEZIONE È COMPOSTA DA DUE APPLIQUE E DA UNA SOSPENSIONE. IL VETRO È LO STESSO CHE UTILIZZIAMO DA SEMPRE, IL BOROSILICATO, QUESTA VOLTA LAVORATO IN UN TUBOLARE A SEZIONE QUADRATA. SORPRENDENTE È LA QUALITÀ DELLA LUCE ESPRESSA DAI LED REALIZZATI IN ITALIA AD HOC PER QUESTA LINEA. LE APPLIQUE VENGONO MONTATE A MURO CON UN SISTEMA AD AGGANCIO RAPIDO "CLIP-ON" COSÌ DA EVITARE ELEMENTI DI FISSAGGIO ANTIESTETICI. NOVITÀ ED INNOVAZIONE SONO DATE DA UN MAGNETE CHE CONSENTE DI SFILARE COMODAMENTE IL VETRO PER POTERLO PULIRE. LA SOSPENSIONE HA UN FUNZIONALE AGGANCIO JACK FACILISSIMO DA CONNETTERE ALL'ALIMENTAZIONE. L'ABILITÀ PRATICA CHE STA ALLA BASE DI REGULA È STATA QUELLA DI SEMPLIFICARE IL DESIGN ELIMINANDO IL SUPERFLUO E FACENDO RISPLENDERE SOLO IL NECESSARIO.



AP1621.30
Glass: transparent
Structure: black carbon

AP1621.46
Glass: transparent
Structure: french gold

AP1621.30
Glass: transparent
Structure: champagne



2x AP1621.46
AP1621.30
Glass: amber (05)
Structure: french gold



1623.106
Glass: fume
Structure: champagne



4x 1626.30
Glass: transparent
Structure: champagne

2x AP1621.30
Glass: transparent
Structure: champagne





COLORI, MATERIALI, FINITURE / CMF

COLORI VETRO DISPONIBILI / AVAILABLE GLASS COLOURS



01 - Trasparente
Transparent



03 - Rosa
Pink



05 - Ambra
Amber



06 - Verde
Green



07 - Azzurro
Sky-Blue



08 - Fumè
Fume



16 - Tabacco
Tobacco



17 - Rubino
Ruby

FINITURA STRUTTURA/ CORPO METALLICO A VISTA DISPONIBILE / AVAILABLE METALLIC FINISHES FOR METAL-BODY-STRUCTURE



Black Carbon
Black Carbon



French gold
French gold



Champagne
Champagne

CARATTERISTICHE TECNICHE / TECHNICAL FEATURES

MATERIALI: VETRO BOROSILICATO E LEGA METALLICA / MATERIALS: BOROSILICATE GLASS AND METAL ALLOY FRAME

COMPATIBILE CON CASAMBI / COMPATIBLE WITH CASAMBI

DIMMERABILE A TAGLIO DI FASE / TRIAC DIMMABLE

LED (COB) E DRIVER INCLUSI / LED (COB) AND DRIVER INCLUDED

SCHEDA LED SOSTITUIBILE DA PROFESSIONISTA / LED BOARD REPLACEABLE BY PROFESSIONAL

I LUMEN INDICATI CORRISPONDONO ALL'INTENSITÀ LUMINOSA ALL'ORIGINE DELLA SCHEDA LED / LUMEN INDICATED CORRESPONDS TO THE LUMINOUS INTENSITY AT THE ORIGIN OF THE LED BOARD

DURATA DEL LED 50.000 ORE / LED LIFESPAN 50.000 HOURS

CAVO ELETTRICO NERO O TRASPARENTE CON ALIMENTAZIONE JACK / BLACK OR TRANSPARENT ELECTRIC CABLE WITH POWER JACK

SORGENTE LUMINOSA / LIGHTING SOURCE:

LED DISPONIBILE PER APPLIQUE AP1621.30 E PLAFONIERA 1626.30 / LEDS AVAILABLE FOR WALL LAMP AP1621.30 E CEILING LAMP 1626.30

• **LED 1x 15W - 24V - 625mA - CRI Typ 95 - 2.040 Lm - 136 Lm/W - 120° - 3 Step MacAdam - 2700K or 3000K**

LED DISPONIBILE PER APPLIQUE AP1621.46 E PLAFONIERA 1626.46 / LEDS AVAILABLE FOR WALL LAMP AP1621.46 E CEILING LAMP 1626.46

• **LED 1x 24W - 24V - 750mA - CRI Typ 95 - 3.264 Lm - 136 Lm/W - 120° - 3 Step MacAdam - 2700K or 3000K**

LED DISPONIBILE PER SOSPENSIONE ORIZZONTALE 1623.106 / LEDS AVAILABLE FOR HORIZONTAL HANGING LAMP 1623.106

• **LED 1x 60W - 24V - 2.500mA - CRI Typ 95 - 8.160 Lm - 136 Lm/W - 120° - 3 Step MacAdam - 2700K or 3000K**

ON DEMAND / OPTIONAL FEATURES

- **PERSONALIZZAZIONE LUNGHEZZA DEL CAVO DELLA SOSPENSIONE SU RICHIESTA / CUSTOMISED CABLE LENGTH OF HANGING LAMP ON REQUEST**
- **A RICHIESTA CON COMPONENTI UL / ON DEMAND WITH UL COMPONENTS**
- **DISPONIBILE SU RICHIESTA CON DRIVER DALI / AVAILABLE ON REQUEST WITH DALI DRIVER**

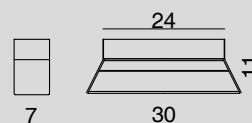
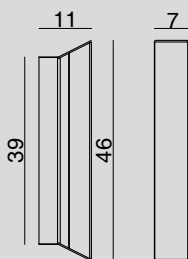
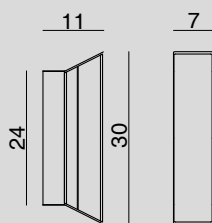

AP1621.30

APPLIQUE / WALL LAMP

L 7 - P 11 - H 30 cm

1 x LED 15W DIMM

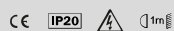

AP1621.46

APPLIQUE / WALL LAMP

L 7 - P 11 - H 46 cm

1 x LED 24W DIMM

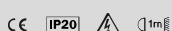

1626.30

PLAFONIERA / CEILING LAMP

L 30 - P 7 - H 11 cm

1 x LED 15W DIMM

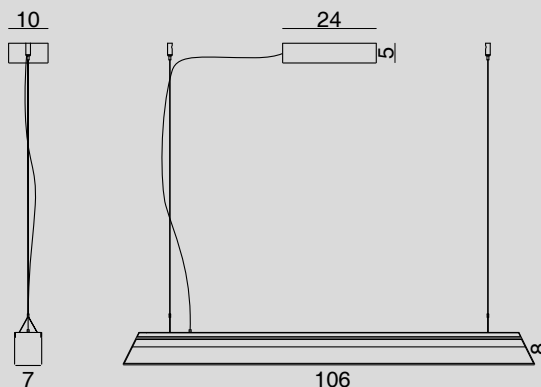
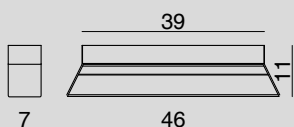
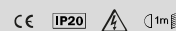

1626.46

PLAFONIERA / CEILING LAMP

L 46 - P 7 - H 11 cm

1 x LED 24W DIMM

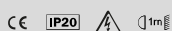

1623.106

SOSPENSIONE A ROSONE / HANGING LAMP
 WITH CANOPY

L 106 - P 7 - H 8 cm - Cable 200 cm

1 x LED 60W DIMM

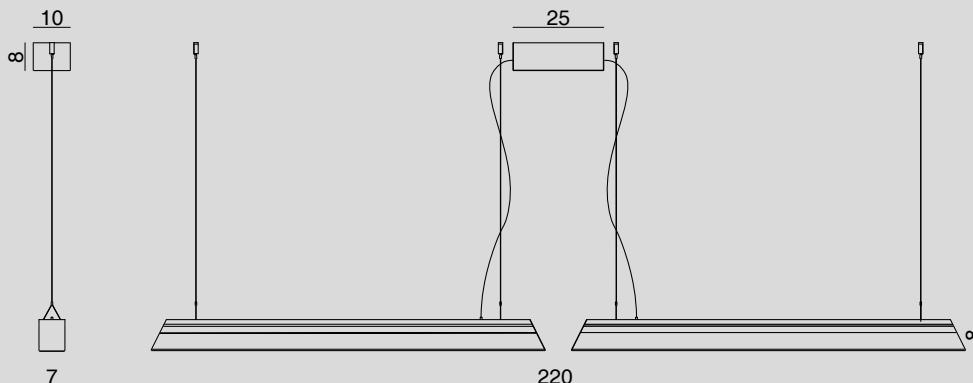
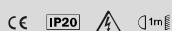

1623.106.2L

SOSPENSIONE A ROSONE / HANGING LAMP
 WITH CANOPY

L 220 - P 7 - H 8 cm - Cable 200 cm

2 x LED 60W DIMM

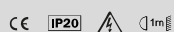



1601 (CALATHEA)

1602 (FICUS)

1603 (PILEA)

Glass: amber (05), green (06), sky-blue (07), ruby (17)

Structure: satin gold



VEGETAL ©

DESIGN:  MARCANTONIO® (2023)



“LA NATURA E LA LUCE MOSTRANO DA SEMPRE UNA STRETTA CORRELAZIONE. NON PUÒ ESSERCI VITA SENZA LA LUCE E DA QUESTO NASCE L’IDEA DI CREARE QUATTRO LAMPADE CHE RIPRENDANO IL CONCETTO DI LUCE CHE FILTRA ATTRAVERSO LE FOGLIE.

-FICUS: IL FICUS NELL’IMMAGINARIO RAPPRESENTA L’ACCOGLIENZA, LA RICONOSCENZA E IL RISPETTO.

-PILEA: CONOSCIUTA SPESSO COME PIANTA DELLE MONETE CINESI, IN REALTÀ POSSIEDE UN SIGNIFICATO BEN PIÙ PROFONDO LEGATO ALL’AMICIZIA; LE SUE GEMME POSSONO ESSERE STACCATE E REGALATE DIVENENDO UN PORTAFORTUNA.

-CALATHEA: CONSIDERATA DA SEMPRE LA PIANTA DELLA PREGHIERA POICHÈ DURANTE LA NOTTE POSSIEDE LA STRANA ABITUDINE DI CHIUDERE LE FOGLIE VICINO LO STELO A DUE A DUE QUASI A MIMARE DELLE MANI GIUNTE IN PREGHIERA.

-PALMA: DA SEMPRE UNA DELLE PIANTE PIÙ CELEBRI, POSSIEDE LA CAPACITÀ DI FIORIRE QUANDO ORMAI SEMBRA IN FIN DI VITA.” MARCANTONIO

"NATURE AND LIGHT HAVE ALWAYS BEEN CLOSELY CORRELATED. THERE CAN BE NO LIFE WITHOUT LIGHT, HENCE THE IDEA OF CREATING FOUR LAMPS THAT CONVEY THE CONCEPT OF LIGHT FILTERED THROUGH LEAVES.

- FICUS: IN OUR IMAGINATION, THE FICUS REPRESENTS HOSPITALITY, GRATITUDE AND RESPECT.
- PILEA: OFTEN KNOWN AS THE CHINESE MONEY PLANT, THE PILEA ACTUALLY HAS A MUCH DEEPER MEANING LINKED TO FRIENDSHIP; ITS SHOOTS CAN BE DETACHED AND GIFTED, BECOMING GOOD LUCK CHARMS.
- CALATHEA: LONG CONSIDERED THE PLANT OF PRAYER, BECAUSE AT NIGHT IT HAS THE STRANGE HABIT OF FOLDING THE LEAVES NEAR THE STEM IN PAIRS, ALMOST MIMICKING HANDS JOINED IN PRAYER.
- PALM: ALWAYS ONE OF THE BEST-KNOWN PLANTS, THE PALM HAS THE ABILITY TO FLOWER EVEN WHEN IT APPEARS TO BE DYING." MARCANTONIO



1601.1L (CALATHEA)
1602.1L (FICUS)
1603.1L (PILEA)
Glass: transparent
Structure: satin gold



1601.1L (CALATHEA)
Glass: transparent
Structure: satin black nickel

1602.1L (FICUS)
Glass: transparent
Structure: satin black nickel

1603.1L (PILEA)
Glass: transparent
Structure: satin black nickel



1604.1L (PALMA)
Glass: transparent
Structure: satin black nickel

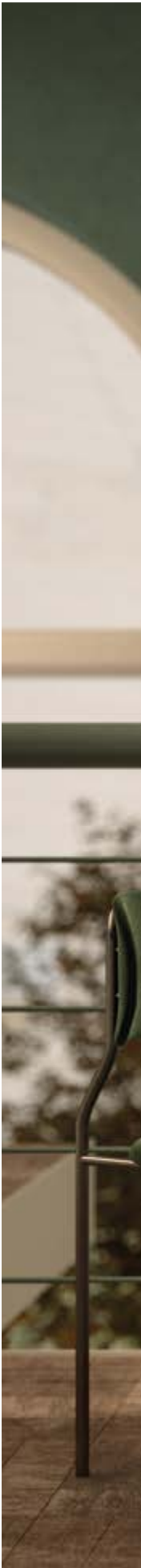





COLORI, MATERIALI, FINITURE / CMF

COLORI VETRO DISPONIBILI / AVAILABLE GLASS COLOURS



01 - Trasparente
Transparent



03 - Rosa
Pink



05 - Ambra
Amber



06 - Verde
Green



07 - Azzurro
Sky-Blue



08 - Fumè
Fume



16 - Tabacco
Tobacco



17 - Rubino
Ruby

FINITURA STRUTTURA/ CORPO METALLICO A VISTA DISPONIBILE / AVAILABLE METALLIC FINISHES FOR METAL-BODY-STRUCTURE



Oro satinato
Satin gold



Nichel nero satinato
Satin black nickel

FINITURA DISPONIBILE PER: PIASTRE, BINARI E DISASSATORI / FINISH AVAILABLE FOR: PLATES, TRACKS AND SPACERS



Cromo
Chrome



Cromo spazzolato
Brushed chrome



Nero opaco
Matt black



Bianco opaco
Matt white

CARATTERISTICHE TECNICHE / TECHNICAL FEATURES

MATERIALI: VETRO BOROSILICATO, ALLUMINIO E ACCIAIO INOSSIDABILE / MATERIALS: BOROSILICATE GLASS, ALUMINIUM AND STAINLESS STEEL

COMPATIBILE CON CASAMBI / COMPATIBLE WITH CASAMBI

DIMMERABILE A TAGLIO DI FASE / TRIAC DIMMABLE

LED (COB) E DRIVER INCLUSI / LED (COB) AND DRIVER INCLUDED

SCHEDA LED SOSTITUIBILE DA PROFESSIONISTA / LED BOARD REPLACEABLE BY PROFESSIONAL

I LUMEN INDICATI CORRISPONDONO ALL'INTENSITÀ LUMINOSA ALL'ORIGINE DELLA SCHEDA LED / LUMEN INDICATED CORRESPONDS TO THE LUMINOUS INTENSITY AT THE ORIGIN OF THE LED BOARD

DURATA DEL LED 50.000 ORE / LED LIFESPAN 50.000 HOURS

CAVO ELETTRICO COASSIALE A BASSA TENSIONE TRASPARENTE O NERO / COAXIAL LOW VOLTAGE ELECTRIC CABLE IN TRANSPARENT OR BLACK

ARTICOLO 1604 (PALMA) REALIZZATO CON ASTA RIGIDA / PRODUCT 1604 (PALMA) MADE WITH METAL ROD

SORGENTE LUMINOSA / LIGHTING SOURCE:

LED DISPONIBILE PER LAMPADA A SOSPENSIONE 1601, 1602, 1603 / LEDS AVAILABLE FOR HANGING LAMP 1601, 1602, 1603

• LED 1x 4,2W - 11,2V-12,8V - 350mA - CRI Typ 95 - 500 Lm - 120 Lm/W - 180° - 3 Step MacAdam - 2700K or 3000K

LED DISPONIBILE PER LAMPADA A SOSPENSIONE 1604.1L (PALMA), / LEDS AVAILABLE FOR TABLE LAMP AND HANGING LAMP 1604.1L (PALMA)

• LED 1x 6W - 11,2V-12,8V - 500mA - CRI Typ 95 - 866 Lm - 144 Lm/W - 180° - 3 Step MacAdam - 2700K or 3000K

ON DEMAND / OPTIONAL FEATURES

- **PERSONALIZZAZIONE LUNGHEZZA DEL CAVO SU RICHIESTA / CUSTOMISED CABLE LENGTH ON REQUEST**
- **A RICHIESTA CON COMPONENTI UL / ON DEMAND WITH UL COMPONENTS**
- **DISPONIBILE SU RICHIESTA CON DRIVER DALI / AVAILABLE ON REQUEST WITH DALI DRIVER**
- **ARTICOLO 1604 (PALMA) PUÒ ESSERE REALIZZATO CON ASTA RIGIDA DA 60 O 80 CM INVECE DI 45 CM / PRODUCT 1604 (PALMA) CAN BE MADE WITH METAL ROD LONG 60 OR 80 CM INSTEAD OF 45 CM**



1601.1L

SOSPENSIONE A ROSONE / HANGING LAMP WITH CANOPY

Glass 1 x Ø 12 cm - Cable 200 cm

1 x LED 4,2 W DIMM

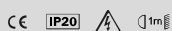

1602.1L

SOSPENSIONE A ROSONE / HANGING LAMP WITH CANOPY

Glass 1 x Ø 12 cm - Cable 200 cm

1 x LED 4,2 W DIMM

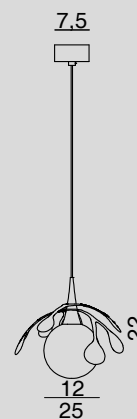
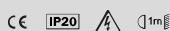

1603.1L

SOSPENSIONE A ROSONE / HANGING LAMP WITH CANOPY

Glass 1 x Ø 12 cm - Cable 200 cm

1 x LED 4,2 W DIMM

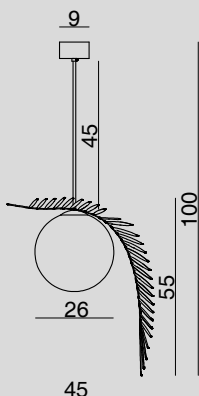

1604.1L

SOSPENSIONE A ROSONE CON ASTA / HANGING LAMP WITH CANOPY AND METAL ROD

Glass 1 x Ø 26 cm

1 x LED 6 W DIMM

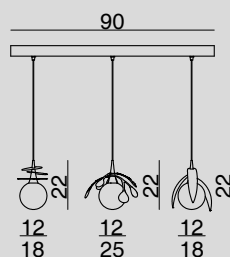
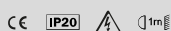

1607MX.90.3L

SOSPENSIONE A BINARIO / HANGING LAMP WITH TRACKS

Glass 3 x Ø 12 cm - Cable 200 cm

3 x LED 4,2 W DIMM

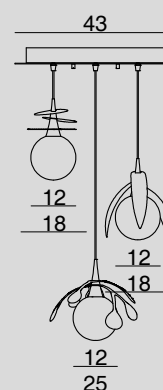
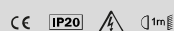

1609MX.43.3L

SOSPENSIONE A PIASTRA / HANGING LAMP WITH CEILING PLATE

Glass 3 x Ø 12 cm - Cable 200 cm

3 x LED 4,2 W DIMM

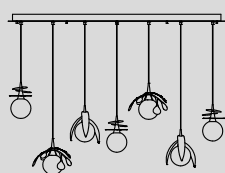
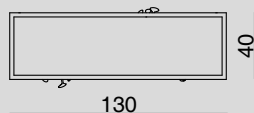
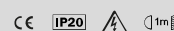

1609MX.40X130.7L

SOSPENSIONE A PIASTRA / HANGING LAMP WITH CEILING PLATE

Glass 7 x Ø 12 cm - Cable 200 cm

7 x LED 4,2 W DIMM

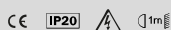

1253.1L
GIG1253.1L
Glass: fume (08)





LACRIMA[©]

DESIGN: PIETRO TUCCI (2013)



1259MX.3L
Glass: fume, transparent, amber



R1253.1L
Glass: amber



AP1251.1L
Glass: tobacco (16)





COLORI, MATERIALI, FINITURE / CMF

COLORI VETRO DISPONIBILI / AVAILABLE GLASS COLOURS



01 - Trasparente
Transparent



03 - Rosa
Pink



05 - Ambra
Amber



06 - Verde
Green



07 - Azzurro
Sky-Blue



08 - Fumè
Fume



16 - Tabacco
Tobacco



17 - Rubino
Ruby

FINITURA STRUTTURALE/ CORPO METALLICO A VISTA DISPONIBILE / AVAILABLE METALLIC FINISHES FOR METAL-BODY-STRUCTURE



Cromo
Chrome

FINITURA DISPONIBILE PER: PIASTRE, BINARI E DISASSATORI / FINISH AVAILABLE FOR: PLATES, TRACKS AND SPACERS



Cromo
Chrome



Cromo spazzolato
Brushed chrome



Nero opaco
Matt black



Bianco opaco
Matt white

CARATTERISTICHE TECNICHE / TECHNICAL FEATURES

MATERIALI: VETRO BOROSILICATO E OTTONE / MATERIALS: BOROSILICATE GLASS AND BRASS

CAVO ELETTRICO TRASPARENTE / TRANSPARENT ELECTRIC CABLE

SORGENTE LUMINOSA / LIGHTING SOURCE:

- E14, E27 (IN BASE ALLA TIPOLOGIA / DEPENDING ON TYPE)
- LAMPADINA NON INCLUSA / BULB NOT INCLUDED

ON DEMAND / OPTIONAL FEATURES

- PERSONALIZZAZIONE LUNGHEZZA DEL CAVO SU RICHIESTA / CUSTOMISED CABLE LENGTH ON REQUEST
- A RICHIESTA CON COMPONENTI UL / ON DEMAND WITH UL COMPONENTS
- A RICHIESTA: SOSPENSIONE E14 PUÒ ESSERE REALIZZATA CON ATTACCO E27 / ON DEMAND: HANGING LAMPS WITH E14 CAN BE MADE WITH E27

Per VETRO RIGATO:

aggiungere la lettera R davanti
al codice al momento dell'ordine

For RIBBED GLASS:

add the letter R in front of the
code when ordering



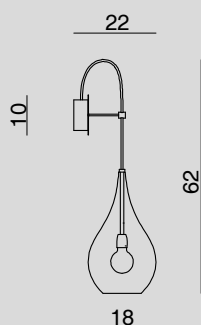

AP1251.1L

APPLIQUE / WALL LAMP

Glass 1 x Ø 18 cm - Cable 50 cm

1 x E14 42 W

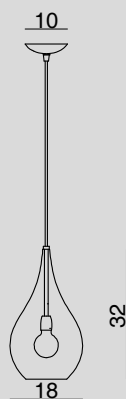
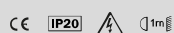

1253.1L

SOSPENSIONE A ROSONE / HANGING LAMP
 WITH CANOPY

Glass 1 x Ø 18 cm - Cable 150 cm

1 x E14 42 W

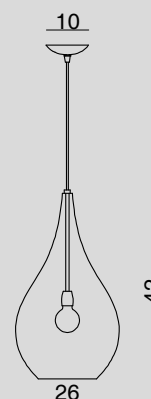
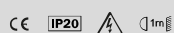

GIG1253.1L

SOSPENSIONE A ROSONE / HANGING LAMP
 WITH CANOPY

Glass 1 x Ø 26 cm - Cable 150 cm

1 x E27 70 W

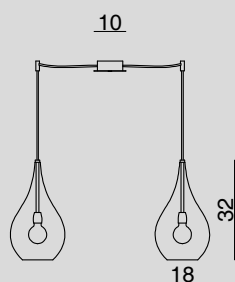
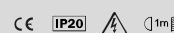

1253.2L

SOSPENSIONE A ROSONE / HANGING LAMP
 WITH CANOPY

Glass 2 x Ø 18 cm - Cable 250 cm

2 x E14 42 W

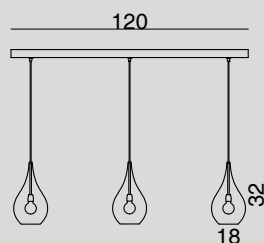

1257.120.3L

SOSPENSIONE A BINARIO / HANGING LAMP
 WITH TRACKS

Glass 3 x Ø 18 cm - Cable 150 cm

3 x E14 42 W

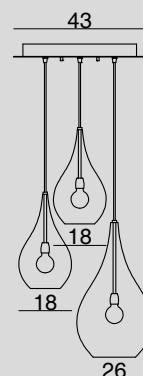
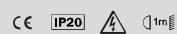

1259MX.3L

SOSPENSIONE A PIASTRA / HANGING LAMP
 WITH CEILING PLATE

Glass 2 x Ø 18-26 cm - Cable 150 cm

2 x E14 42 W 1 x E27 70 W

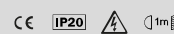



PARIGI ©

DESIGN: PIETRO TUCCI (2012)





3x **MED1213.1L**
Glass: transparent (01)



RMED1213.1L
Glass: tobacco (16)

2x 1203
2x MED1203
2x GIG1203
Glass: transparent (01)





LUGIG1213

Glass: tobacco (16)

Lampshade: li-natural white

PARALUME IN LINO OLANDA DISPONIBILE PER LA LINEA PARIGI / LINO OLANDA LAMP SHADE AVAILABLE FOR PARIGI



LI - BIANCO NATURALE
LI - NATURAL WHITE



COLORI, MATERIALI, FINITURE / CMF

COLORI VETRO DISPONIBILI / AVAILABLE GLASS COLOURS



01 - Trasparente
Transparent



03 - Rosa
Pink



05 - Ambra
Amber



06 - Verde
Green



07 - Azzurro
Sky-Blue



08 - Fumè
Fume



16 - Tabacco
Tobacco



17 - Rubino
Ruby

FINITURA STRUTTURA/ CORPO METALLICO A VISTA DISPONIBILE / AVAILABLE METALLIC FINISHES FOR METAL-BODY-STRUCTURE



Cromo
Chrome

FINITURA DISPONIBILE PER: PIASTRE, BINARI E DISASSATORI / FINISH AVAILABLE FOR: PLATES, TRACKS AND SPACERS



Cromo
Chrome



Cromo spazzolato
Brushed chrome



Nero opaco
Matt black



Bianco opaco
Matt white

CARATTERISTICHE TECNICHE / TECHNICAL FEATURES

MATERIALI: VETRO BOROSILICATO E OTTONE / MATERIALS: BOROSILICATE GLASS AND BRASS

CAVO ELETTRICO TRASPARENTE / TRANSPARENT ELECTRIC CABLE

PARALUME IN LINO OLANDA DISPONIBILE PER LA LINEA PARIGI: LI - BIANCO NATURALE / LINO OLANDA LAMPSHADE AVAILABLE FOR PARIGI: LI
NATURAL WHITE

SORGENTE LUMINOSA / LIGHTING SOURCE:

- E14, E27 (IN BASE ALLA TIPOLOGIA / DEPENDING ON TYPE)
- LAMPADINA NON INCLUSA / BULB NOT INCLUDED

ON DEMAND / OPTIONAL FEATURES

- PERSONALIZZAZIONE LUNGHEZZA DEL CAVO SU RICHIESTA / CUSTOMISED CABLE LENGTH ON REQUEST
- A RICHIESTA CON COMPONENTI UL / ON DEMAND WITH UL COMPONENTS

Per VETRO RIGATO:

aggiungere la lettera R davanti
al codice al momento dell'ordine

For RIBBED GLASS:

add the letter R in front of the
code when ordering

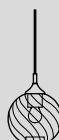

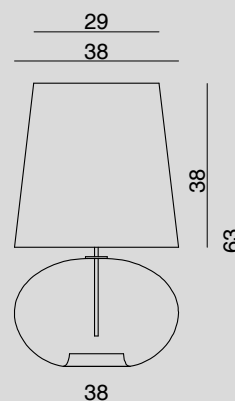
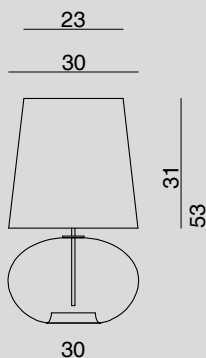
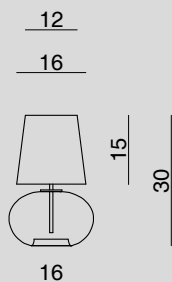

LU1213

LAMPADA DA TAVOLO / TABLE LAMP

Glass 1 x Ø 16 cm - Cable 200 cm

1 x E14 40 W

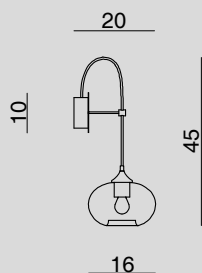
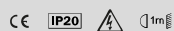

LUG1213

LAMPADA DA TAVOLO / TABLE LAMP

Glass 1 x Ø 30 cm - Cable 200 cm

1 x E27 60 W

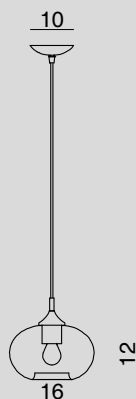
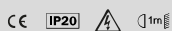

LUXXL1213

LAMPADA DA TAVOLO / TABLE LAMP

Glass 1 x Ø 38 cm - Cable 200 cm

1 x E27 60 W

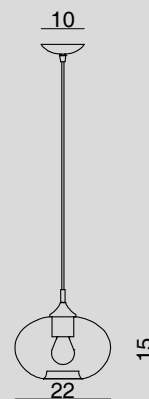
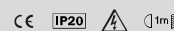

AP1211.1L

APPLIQUE / WALL LAMP

Glass 1 x Ø 16 cm

1 x E14 42 W

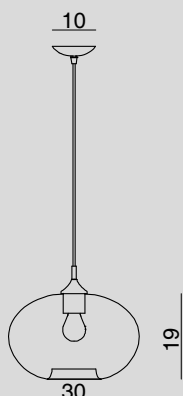
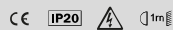

1213.1L

SOSPENSIONE A ROSONE / HANGING LAMP WITH CANOPY

Glass 1 x Ø 16 cm - Cable 150 cm

1 x E14 42 W

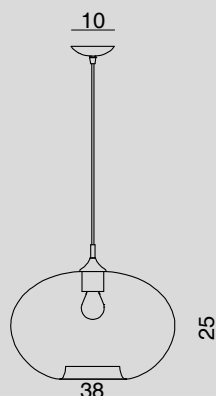
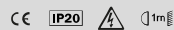

MED1213.1L

SOSPENSIONE A ROSONE / HANGING LAMP WITH CANOPY

Glass 1 x Ø 22 cm - Cable 150 cm

1 x E27 70 W

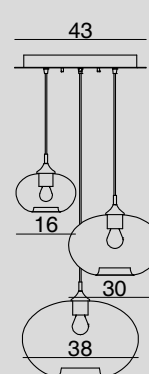
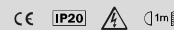

GIG1213.1L

SOSPENSIONE A ROSONE / HANGING LAMP WITH CANOPY

Glass 1 x Ø 30 cm - Cable 150 cm

1 x E27 70 W

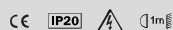

XXL1213.1L

SOSPENSIONE A ROSONE / HANGING LAMP WITH CANOPY

Glass 1 x Ø 38 cm - Cable 150 cm

1 x E27 70 W

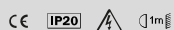

1219MX.3L

SOSPENSIONE A PIASTRA / HANGING LAMP WITH CEILING PLATE

Glass 3 x Ø 16-30-38 cm - Cable 150 cm

1 x E14 42 W 2 x E27 70 W



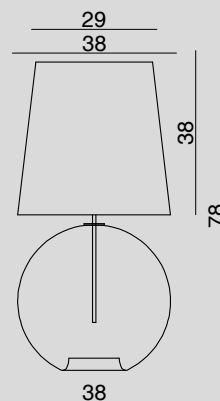
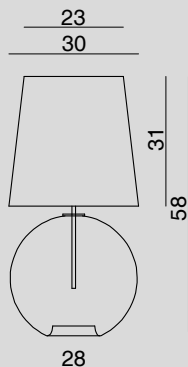
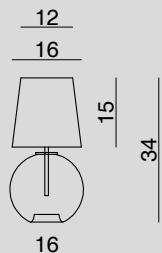

LU1203

LAMPADA DA TAVOLO / TABLE LAMP

Glass 1 x Ø 16 cm - Cable 200 cm

1 x E14 40 W

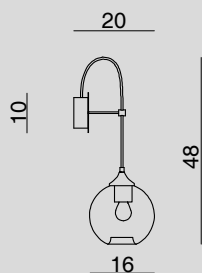
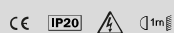

AP1201.1L

APPLIQUE / WALL LAMP

Glass 1 x Ø 16 cm

1 x E14 42 W

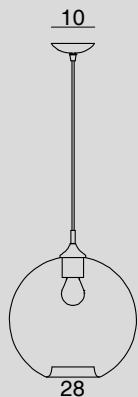
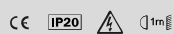

LUGIG1203

LAMPADA DA TAVOLO / TABLE LAMP

Glass 1 x Ø 28 cm - Cable 200 cm

1 x E27 60 W

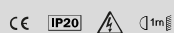

1203.1L

SOSPENSIONE A ROSONE / HANGING LAMP WITH CANOPY

Glass 1 x Ø 16 cm - Cable 150 cm

1 x E14 42 W

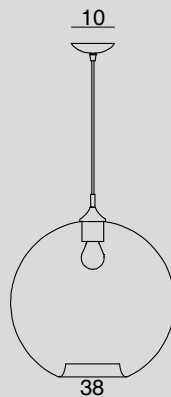
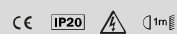

LUXXL1203

LAMPADA DA TAVOLO / TABLE LAMP

Glass 1 x Ø 38 cm - Cable 200 cm

1 x E27 60 W

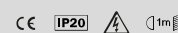

MED1203.1L

SOSPENSIONE A ROSONE / HANGING LAMP WITH CANOPY

Glass 1 x Ø 22 cm - Cable 150 cm

1 x E27 70 W

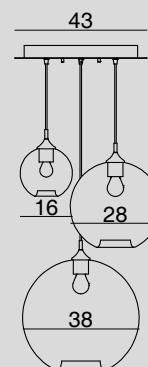
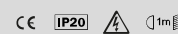

GIG1203.1L

SOSPENSIONE A ROSONE / HANGING LAMP WITH CANOPY

Glass 1 x Ø 28 cm - Cable 150 cm

1 x E27 70 W

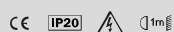

XXL1203.1L

SOSPENSIONE A ROSONE / HANGING LAMP WITH CANOPY

Glass 1 x Ø 38 cm - Cable 150 cm

1 x E27 70 W

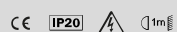

1209MX.3L

SOSPENSIONE A PIASTRA / HANGING LAMP WITH CEILING PLATE

Cable 150 cm

1 x E14 42 W 2 x E27 70 W

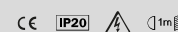

DETTAGLI PRODOTTO
PRODUCT DETAILS



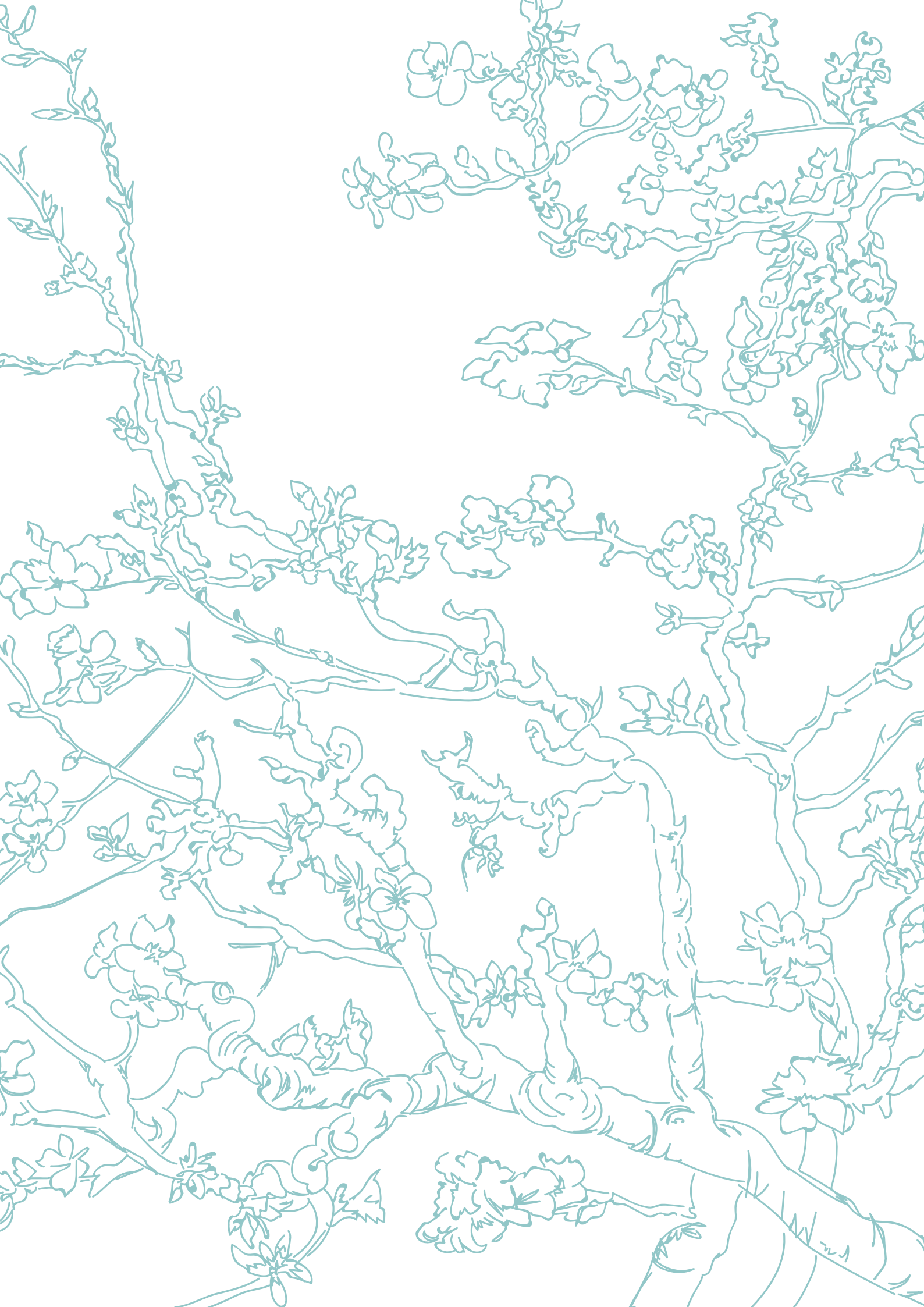



ZOE[®]

DESIGN IN 2020



CANGINI & TUCCI[®]

Van
Gogh
Museum
Amsterdam

La serie di lampade Zoe® Van Gogh è il risultato della collaborazione tra Cangini e Tucci e il Van Gogh Museum di Amsterdam.

The Zoe® Van Gogh series of lamps is the result of the collaboration between Cangini e Tucci and Van Gogh Museum in Amsterdam.

L'arte di Vincent Van Gogh, il più grande pittore impressionista di tutti i tempi, incontra la qualità dell'artigianato e del Made in Italy.

The art of Vincent Van Gogh, the greatest impressionist painter of all time, meets the quality of craftsmanship and Made in Italy.

Tutte le lampade sono infatti progettate e realizzate da Cangini e Tucci, ad opera di maestri soffiatori ed esperte mani artigiane. Le piccole imperfezioni che si riscontrano sulle superfici delle decorazioni sono peculiarità che attestano l'unicità del prodotto e la diversità di ogni prodotto rispetto all'altro e sono quindi da considerarsi motivo di valore aggiunto, proprio come la firma di un grande artista.

All the lamps are designed and made in Cangini e Tucci by expert artisan hands and master glass blowers. The small imperfections that can be found on the surfaces of the decorations are peculiarities that attest the uniqueness of the product and the diversity of each product from the other and are therefore to be considered a reason of value, like the signature of a great artist.



Mandorlo in fiore Almond Blossom



Vincent van Gogh (1853 - 1890),
Saint-Rémy-de-Provence, febbraio 1890
olio su tela, 73,3 cm x 92,4 cm
Crediti (obbligo di dichiarazione):
Museo Van Gogh, Amsterdam
(Fondazione Vincent Van Gogh)

I grandi rami in fiore come questo contro un cielo blu erano uno dei soggetti preferiti di Van Gogh. I mandorli fioriscono all'inizio della primavera e sono un simbolo di nuova vita. Van Gogh ha preso in prestito il soggetto, i contorni audaci e la posizione dell'albero nel piano delle immagini dalla tipografia giapponese.

Il dipinto fu un regalo per il fratello Theo e la cognata Jo, che avevano appena avuto un figlio, Vincent Willem. Nella lettera che annunciava il nuovo arrivo, Theo scriveva: "Come vi abbiamo detto, lo chiameremo come voi, e gli auguro di essere determinato e coraggioso come voi". Non sorprende che sia stato questo lavoro a rimanere più vicino al cuore della famiglia Van Gogh. Vincent Willem fondò poi il Museo Van Gogh.

Vincent van Gogh (1853 - 1890),
Saint-Rémy-de-Provence, February 1890
oil on canvas, 73.3 cm x 92.4 cm
Credits (obliged to state):
Van Gogh Museum, Amsterdam
(Vincent Van Gogh Foundation)

Large blossom branches like this against a blue sky were one of Van Gogh's favourite subjects. Almond trees flower early in the spring making them a symbol of new life. Van Gogh borrowed the subject, the bold outlines and the positioning of the tree in the picture plane from Japanese printmaking.

The painting was a gift for his brother Theo and sister-in-law Jo, who had just had a baby son, Vincent Willem. In the letter announcing the new arrival, Theo wrote: 'As we told you, we'll name him after you, and I'm making the wish that he may be as determined and as courageous as you.' Unsurprisingly, it was this work that remained closest to the hearts of the Van Gogh family. Vincent Willem went on to found the Van Gogh Museum.



Vincent

GIG1523.1L

Glass: transparent + serigraph











AP1521.1L

Glass: metal sky blue + serigraph









LUGIG1520
Glass: metal sky blue





COLORI, MATERIALI, FINITURE / CMF

COLORI VETRO DISPONIBILI / AVAILABLE GLASS COLOURS



Azzurro metal
Metal Sky blue



Trasparente + serigrafia
Transparent + serigraph



Azzurro metal + serigrafia
Metal sky blue + serigraph

COLORI VETRO PER LAMPADE DA TAVOLO / GLASS COLOUR AVAILABLE FOR TABLE LAMPS



Azzurro metal
Metal Sky blue



01 - Trasparente
Transparent

FINITURA STRUTTURA/ CORPO METALLICO A VISTA DISPONIBILE / AVAILABLE METALLIC FINISHES FOR METAL-BODY-STRUCTURE



Nero Opaco
Matt Black

CARATTERISTICHE TECNICHE / TECHNICAL FEATURES

CAVO ELETTRICO IN GOMMA NERO / BLACK GUM ELECTRIC CABLE

SORGENTE LUMINOSA / LIGHTING SOURCE:

- E14, E27, LED (IN BASE ALLA TIPOLOGIA / DEPENDING ON TYPE)
- LAMPADINA NON INCLUSA / BULB NOT INCLUDED

• LED DISPONIBILE PER LAMPADE DA TAVOLO CON PARALUME / LED AVAILABLE FOR TABLE LAMPS WITH SHADE:

LED 1x 3,5W - 220,0V-240,0V - 350 Lm - 180°-3000K (I LUMEN INDICATI CORRISPONDONO ALL'INTENSITÀ LUMINOSA ALL'ORIGINE DELLA SCHEDA LED / LUMEN INDICATED CORRESPONDS TO THE LUMINOUS INTENSITY AT THE ORIGIN OF THE LED BOARD)

ON DEMAND / OPTIONAL FEATURES

- PERSONALIZZAZIONE LUNGHEZZA DEL CAVO SU RICHIESTA / CUSTOMISED CABLE LENGTH ON REQUEST
- A RICHIESTA CON COMPONENTI UL / ON DEMAND WITH UL COMPONENTS

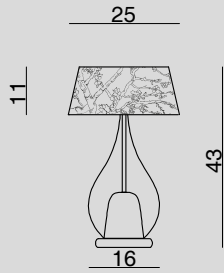

LU1520

LAMPADA DA TAVOLO / TABLE LAMP

Glass 1 x Ø 16 cm - Cable 200 cm
 1 x E14 40 W 1 x LED 3,5 W DIMM

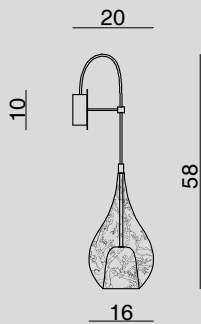
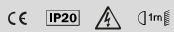

AP1521.1L

APPLIQUE / WALL LAMP

Glass 1 x Ø 16 cm - Cable 50 cm
 1 x E14 60 W

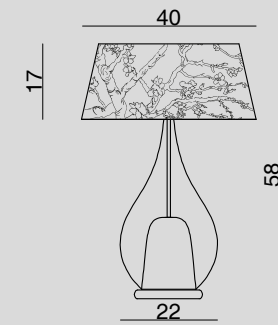
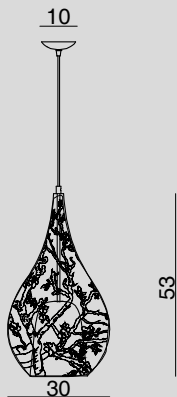
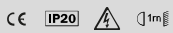

LUG1520

LAMPADA DA TAVOLO / TABLE LAMP

Glass 1 x Ø 22 cm - Cable 200 cm
 1 x E27 60 W 1 x LED 3,5 W DIMM

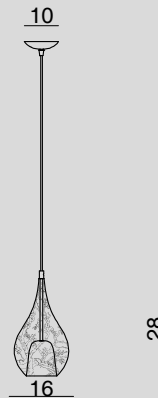
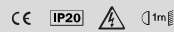

1523.1L

SOSPENSIONE A ROSONE / HANGING LAMP WITH CANOPY

Glass 1 x Ø 16 cm - Cable 150 cm
 1 x E14 60 W

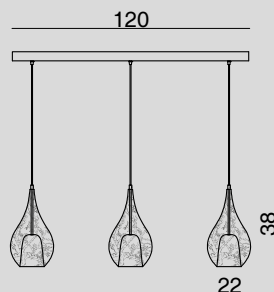
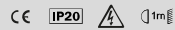

GIG1527.120.3L

SOSPENSIONE A BINARIO / HANGING LAMP WITH TRACKS

Glass 3 x Ø 22 cm - Cable 150 cm
 3 x E27 105 W

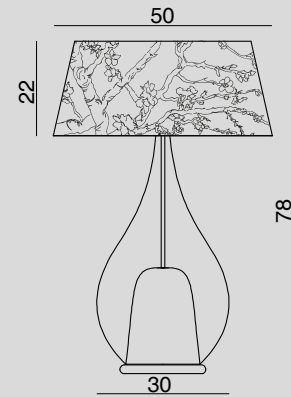
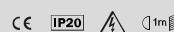

LUXXL1520

LAMPADA DA TAVOLO / TABLE LAMP

Glass 1 x Ø 30 cm - Cable 200 cm
 1 x E27 60 W 1 x LED 3,5 W DIMM

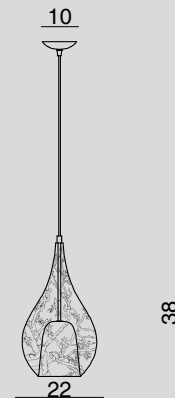
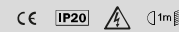

GIG1523.1L

SOSPENSIONE A ROSONE / HANGING LAMP WITH CANOPY

Glass 1 x Ø 22 cm - Cable 150 cm
 1 x E27 105 W

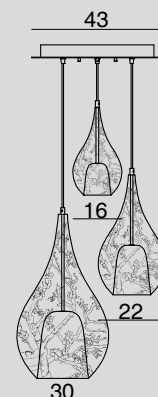
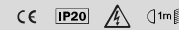

1529MX.3L

SOSPENSIONE A PIASTRA / HANGING LAMP WITH CEILING PLATE

Glass 3 x Ø 16-22-30 cm - Cable 150 cm
 1 x E14 60 W 2 x E27 105 W

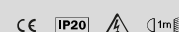

XXL1523.1L

SOSPENSIONE A ROSONE / HANGING LAMP WITH CANOPY

Glass 1 x Ø 30 cm - Cable 150 cm
 1 x E27 105 W

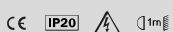



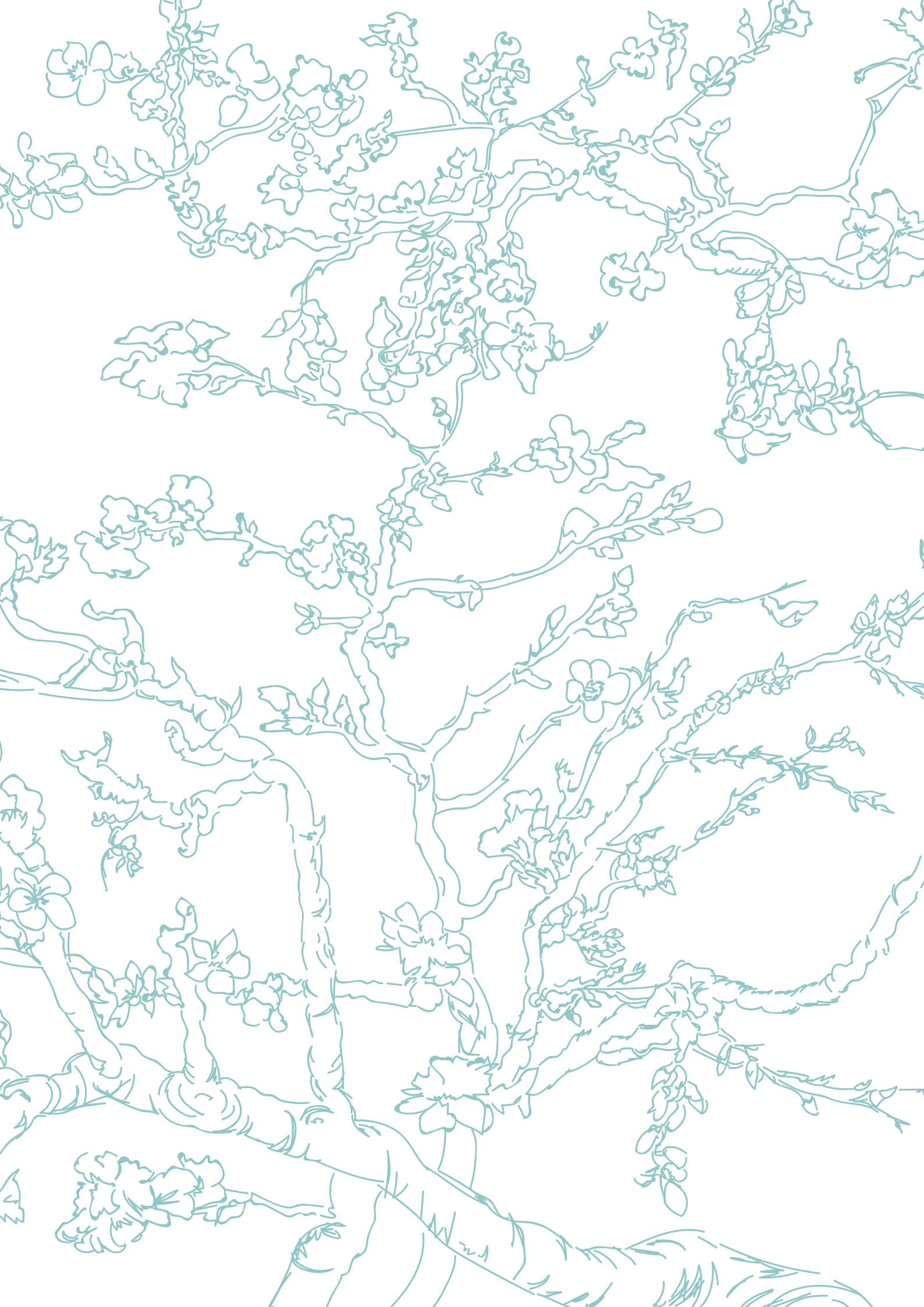



ZOE XXL1303.1L
Glass: bronze

PHOTOS: HERBERT LEHMANN
PROJEKT: BOGLERHOF HOTEL - AUSTRIA



REFERENCES



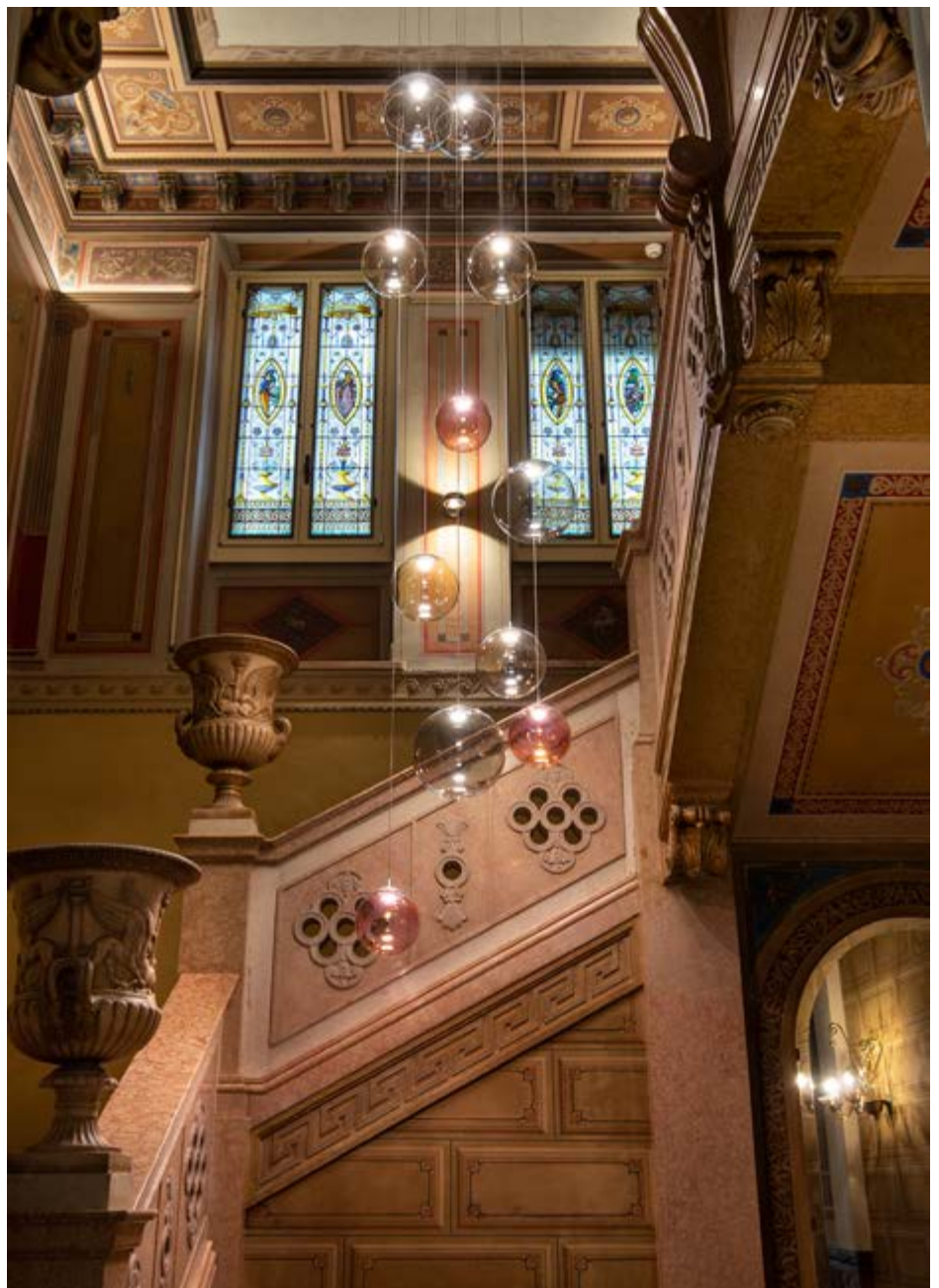

PIT SPECIAL FIXTURE

Glass: coloured mix

PHOTOS: MAURO PINI

**PROJECT: HOTEL VILLA CORTINE
SIRMIONE (BS)**

**ARCHITETTO CERESOLI CARLO
IN COLLABORAZIONE
CON OFFICINA LUCE**





ZOE 1303, GIG1303
Glass: sky-blue (07), green (06), ruby (17)

DORELAN





ZOE 1303, GIG1303, XXL1303

Glass: metallic mix

PIT 1583, GIG1583, XXL1583

Glass: transparent (01), tobacco (16) fume (08)

PACINI & CAPPELLINI MILANO





30x ECLISSE 1293
Custom plate diam. 75 cm

**PROJECT: TH2 WHITE
INTERIOR DESIGN HAMBURG**



30x ECLISSE 1293
Custom plate diam. 75 cm

**PROJECT: TH2 WHITE
INTERIOR DESIGN HAMBURG**

30x ECLISSE 1293
Custom plate diam. 75 cm

**PROJECT: TH2 WHITE
INTERIOR DESIGN HAMBURG**







FREQUENCY 1553.OR.2, GIG1553.OR.2
Glass: transparent (01)

ZOE LUGIG1520
Glass: metal sky blue

SPACE EDITION SHOWROOM - THAILAND









PIT SPECIAL FIXTURE

Glass: amber (05), tobacco (16) fume (08)

PHOTOS: JAN HAESLICH PHOTOGRAPHIE - ZUHAUSE

PROJECT: LICHTJA – LICHT UND MEHR GMBH





ECLISSE 1293
Glass: amber

PHOTOS: URBANIWIRT
PROJECT: ARCH. RONACHER
LIGHTING DESIGN: WEGE-LICHT





3x ZOE GIG1303

Glass: fume (08), black, green (06)

PROJECT: LICHTKONZEPT HOFER /
GERDT ARCHITEKTUR - HAMBURG

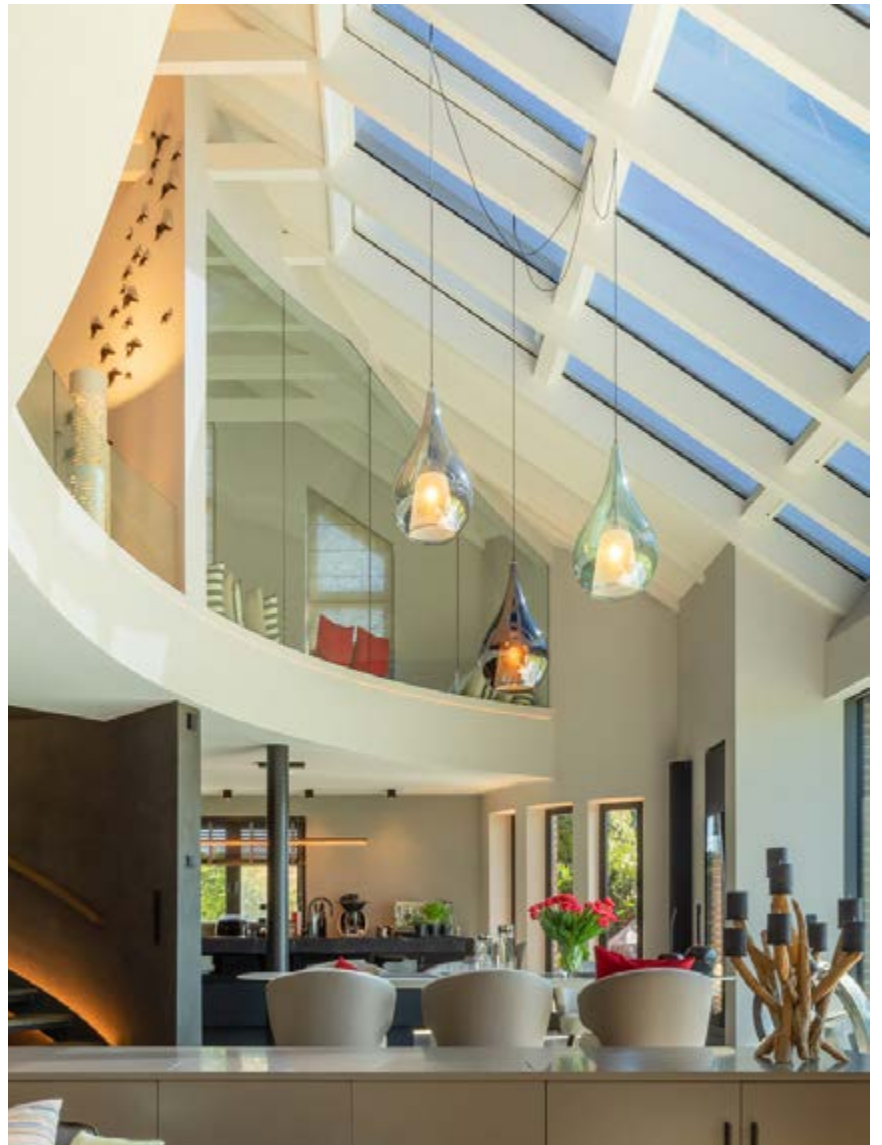



ECLISSE MAX 1569MX.50.5L
Glass: bronze, black

PROJECT: PS LICHT - HANNOVER





3x ZOE MAX1303.1L
Glass: black

PROJECT: YANNICK ZAEH - ZS ECLAIRAGE



ZOE GIG1303

HOTEL MEZDI ***S
PHOTOS: VISCIANI PHOTOGRAPHY









ZOE GIG1303.1L
ZOE VGM LUG1520

PHOTOS: STUDIOME
LOCATION: CESENA



GUIDA ALLA PERSONALIZZAZIONE

CUSTOMISATION GUIDELINES



DI SEGUITO SONO RIPORTATE ALCUNE LINEE GUIDA PER LA PERSONALIZZAZIONE DEI NOSTRI PRODOTTI.

SCOPRI LE DIVERSE POSSIBILITÀ, DALLE FINITURE ALLE MODALITÀ DI INSTALLAZIONE.

BELOW ARE SOME GUIDELINES FOR CUSTOMISING OUR PRODUCTS.

DISCOVER THE DIFFERENT POSSIBILITIES, FROM FINISHES TO INSTALLATION SYSTEMS.

1° LE FINITURE / THE FINISHES

INDICARE IL CODICE PRODOTTO SEGUITO DAL COLORE DEL VETRO, LA FINITURA METALLICA E LA FINITURA DEL CAVO.

SPECIFY PRODUCT CODE FOLLOWED BY GLASS COLOUR, METAL FINISH AND CABLE FINISH.

CAVO
CABLE

STRUTTURA
STRUCTURE

VETRO
GLASS



2° LE PERSONALIZZAZIONI / CUSTOMISATIONS

INDICARE LA TEMPERATURA DI COLORE DEL LED IN CASO DI COB (LED INTEGRATO 2700K O 3000K) E LA LUNGHEZZA DEL CAVO SE DIVERSA DALLO STANDARD.

SPECIFY THE LED COLOUR TEMPERATURE IN THE CASE OF COB (2700K OR 3000K INTEGRATED LED) AND THE LENGTH OF THE CABLE IF DIFFERENT FROM THE STANDARD.

LUNGHEZZA CAVO
CABLE LENGTH

TEMPERATURA LED
LED TEMPERATURE



3° LE COMPOSIZIONI / COMPOSITIONS

INDICARE IL TIPO DI INSTALLAZIONE E LA QUANTITÀ DI CORPI ILLUMINANTI. (CONSULTARE L'ELENCO DELLE STRUTTURE PER COMPOSIZIONI ALLA PAGINA SEGUENTE).

INDICATE THE TYPE OF INSTALLATION AND THE NUMBER OF LAMPS (SEE THE LIST OF STRUCTURES FOR COMPOSITIONS ON THE NEXT PAGE).

ROSONI, PIASTRE O BINARI
CANOPIES, PLATES OR TRAKS

QUANTITÀ
QUANTITY



4° SU RICHIESTA / ON DEMAND

LE COLLEZIONI CANGINI E TUCCI POSSONO ESSERE COMPOSTE E REALIZZATE ANDANDO INCONTRO ALLE TANTE ESIGENZE TECNICHE ED ESTETICHE:

- SUPPORTO PER LO SVILUPPO DI SOLUZIONI COMPLESSE.
- SUPPORTO TECNICO TRAMITE VISUALIZZAZIONI E DISEGNI 3D.

CANGINI E TUCCI COLLECTIONS CAN BE COMPOSED AND REALISED TO MEET THE MANY TECHNICAL AND AESTHETIC REQUIREMENTS:

- SUPPORT FOR THE DEVELOPMENT OF COMPLEX SOLUTIONS.
- TECHNICAL SUPPORT THROUGH VISUALISATIONS AND 3D DRAWINGS.

BEFORE...



...AFTER



INSTALLAZIONE SINGOLA E MULTIPLA

SINGLE AND MULTIPLE INSTALLATION

ROSONI SINGOLI / SINGLE CANOPIES

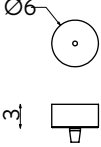
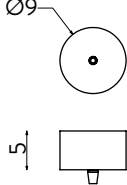
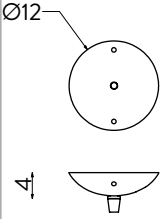
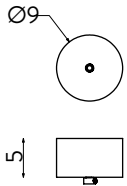
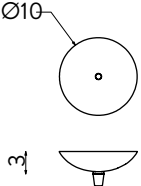
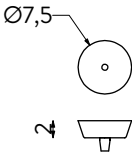
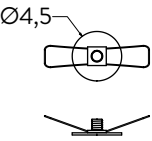
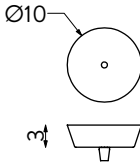
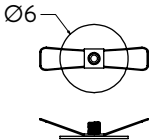
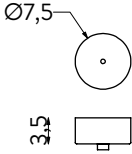
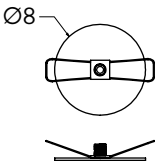
<p>ECL6</p>		<p>Rosone Ø6 - H3 cm (standard per le seguenti lampade: Eclisse, Tao) Canopy Ø6 - H3 cm (standard for the following lightings: Eclisse, Tao)</p>	<p>FOL9</p>		<p>Rosone diam. 9 - H5 cm (standard per le seguenti lampade: Fold, Aeron, Hydra, La Stilla) Canopy Ø9 - H5 cm (standard for the following lamps: Fold, Aeron, Hydra, La Stilla)</p>
<p>LAC12</p>		<p>Rosone Ø12 - H4 cm (standard per le seguenti lampade: Zoe Max) Canopy Ø12 - H4 cm (standard for the following lamps: Zoe Max)</p>	<p>PT9</p>		<p>Rosone Ø9 - H5 cm (standard per le seguenti lampade: Cherry, Dalma, Eclisse Max, Geo, Mark, Pit) Canopy Ø9 - H5 cm (standard for the following lamps: Cherry, Dalma, Eclisse Max, Geo, Mark, Pit)</p>
<p>EST10</p>		<p>Rosone Ø10 - H3 cm (standard per le seguenti lampade: Lacrima, Parigi, Zoe) Canopy Ø10 - H3 cm (standard for the following lamps: Lacrima, Parigi, Zoe)</p>	<p>TRP7,5</p>		<p>Rosone Ø7,5 - H2 cm (standard per le seguenti lampade: Clos) Canopy Ø7,5 - H2 cm (standard for the following lamps: Clos)</p>
<p>INC4,5</p>		<p>Rosone Ø4,5 cm ad incasso (Foro a soffitto massimo Ø3,5 cm) Recessed canopy Ø4,5 cm (Maximum ceiling hole Ø3,5 cm)</p>	<p>TRP10</p>		<p>Rosone Ø10 - H3 cm (standard per le seguenti lampade: Clos Max) Canopy Ø10 - H3 cm (standard for the following lamps: Clos Max)</p>
<p>INC6</p>		<p>Rosone Ø6 cm ad incasso (Foro a soffitto massimo Ø5 cm) Recessed canopy Ø6 cm (Maximum ceiling hole Ø5 cm)</p>	<p>VE7,5</p>		<p>Rosone Ø7,5 - H3,5 cm (standard per le seguenti lampade: Pilea, Calathea, Ficus) Canopy Ø7,5 - H3,5 cm (standard for the following lamps: Pilea, Calathea, Ficus)</p>
<p>INC8</p>		<p>Rosone Ø8 cm ad incasso (Foro a soffitto massimo Ø7 cm) Recessed canopy Ø8 cm (Maximum ceiling hole Ø7 cm)</p>			

ROSONI MULTIPLI/ MULTIPLE CANOPIES

DISASSATORI/ SPACERS

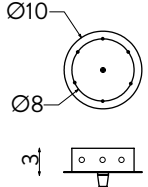
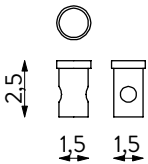
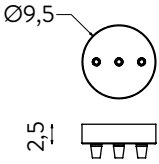
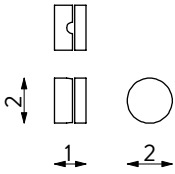
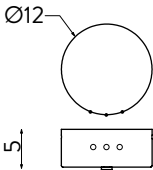
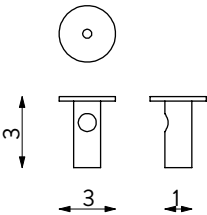
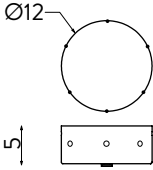
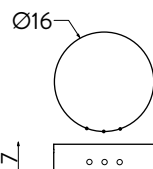
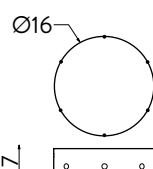
GOC10.M		<p>Rosone Ø10 - H3 cm 2/6 fori laterali (+1 centrale) Canopy Ø10 - H3 cm 2/6 side holes (+1 central)</p>	WS2		<p>Disassatore cilindrico Ø1,5 - H2,5 cm Cylindrical spacer Ø1,5 - H2,5 cm H2,5 cm</p>
ECL9,5		<p>Rosone Ø9,5 - H2,5 cm 3 fori sulla parte inferiore (1 è centrale) Canopy Ø9,5 - H2,5 cm 3 holes on the bottom (1 is central)</p>	WS4		<p>Disassatore Ø2 - H 1 cm (raccomandato per sospensioni con cavo coassiale) Spacer Ø2 - H 1 cm (recommended for suspensions with coaxial cable)</p>
PT12.M.SIDE		<p>Rosone Ø12 cm - H 5 cm (fori laterali personalizzabili SU UN LATO) Canopy Ø12 - H5 cm (customisable holes ON ONE SIDE)</p>	WS5		<p>Disassatore cilindrico con appoggio Ø3 - H3 cm Cylindrical spacer with base support Ø3 - H3 cm</p>
PT12.M.AROUND		<p>Rosone Ø12 cm - H. 5 cm (fori personalizzabili ATTORNO ALLA CIRCONFERENZA) Canopy Ø12 - H5 cm (customisable holes AROUND CIRCUMFERENCE)</p>			
PT15.M.SIDE		<p>Rosone Ø16 cm - h 7 cm (fori laterali personalizzabili su un lato) Canopy Ø16 - H 7 cm (customisable holes ON ONE SIDE)</p>			
PT15.M.AROUND		<p>Rosone Ø16 cm - H. 7 cm (fori personalizzabili ATTORNO ALLA CIRCONFERENZA) Canopy Ø16 - H 7 cm (customisable holes AROUND CIRCUMFERENCE)</p>			

INSTALLAZIONE MULTIPLA

MULTIPLE INSTALLATION

PIASTRE TONDE / ROUND PLATES

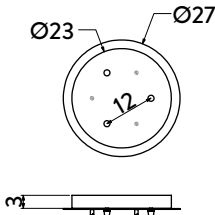
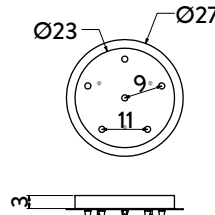
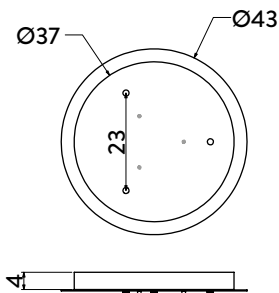
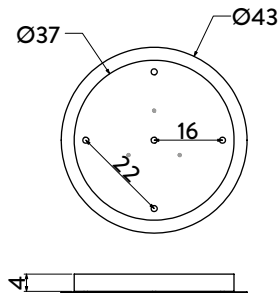
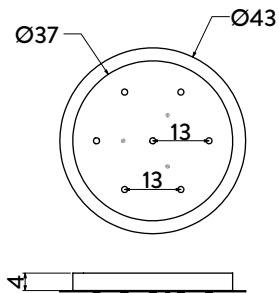
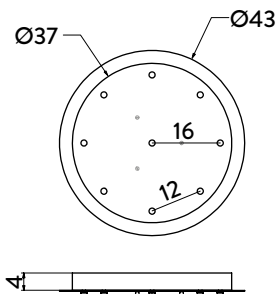
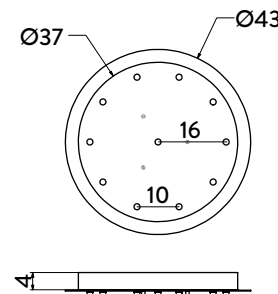
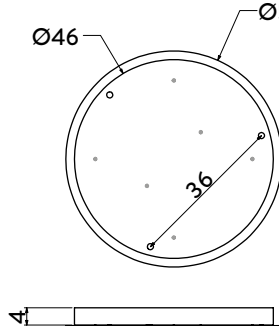
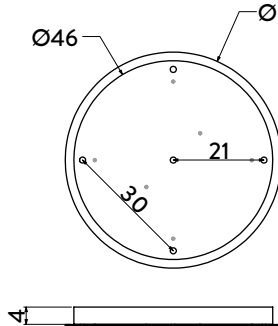
<p>P27.3L</p> <p>P27.6L</p>	<div style="display: flex; justify-content: space-around;"> <div style="text-align: center;"> <p>P27.3L 3 luci 3 lamps</p>  </div> <div style="text-align: center;"> <p>P27.6L 6 luci 6 lamps</p>  </div> </div> <p style="text-align: right;">Piastra Ø27 - H 3 cm con multiple uscite Ceiling plate Ø27 - H 3 cm with multiple exitholes</p>
<p>P43.3L</p> <p>P43.5L</p> <p>P43.7L</p> <p>P43.9L</p> <p>P43.11L</p>	<div style="display: flex; justify-content: space-around;"> <div style="text-align: center;"> <p>P43.3L 3 luci 3 lamps</p>  </div> <div style="text-align: center;"> <p>P43.5L 5 luci 5 lamps</p>  </div> <div style="text-align: center;"> <p>P43.7L 7 luci 7 lamps</p>  </div> </div> <div style="display: flex; justify-content: space-around; margin-top: 20px;"> <div style="text-align: center;"> <p>P43.9L 9 luci 9 lamps</p>  </div> <div style="text-align: center;"> <p>P43.11L 11 luci 11 lamps</p>  </div> </div> <p style="text-align: right;">Piastra Ø43 - H 4 cm con multiple uscite Ceiling plate Ø27 - H 3 cm with multiple exitholes</p>
<p>P50.3L</p> <p>P50.5L</p>	<div style="display: flex; justify-content: space-around;"> <div style="text-align: center;"> <p>P50.3L 3 luci 3 lamps</p>  </div> <div style="text-align: center;"> <p>P50.5L 5 luci 5 lamps</p>  </div> </div> <p style="text-align: right;">Piastra Ø50 - H 4 cm con multiple uscite Ceiling plate Ø50 - H 4 cm with multiple exitholes</p>

SU RICHIESTA È POSSIBILE PERSONALIZZARE PIASTRE/ BINARI NELLE DIMENSIONI E IL NUMERO DI USCITE DEI PENDENTI (VEDI DA PAGINA 308)

UPON REQUEST IS POSSIBLE TO CUSTOMISE CEILING PLATES/ TRACKS ON DIMENSION AND NUMBER OF EXITHOLES OF PENDANTS (SEE FROM PAGE 308)

Auf Anfrage kann man bei Deckenplatte/Schienen die Größen und Auslassen-Nummer maßgefertigen (ab Seite 308)

PIASTRE QUADRATE E RETTANGOLARI / SQUARE AND RECTANGULAR PLATES

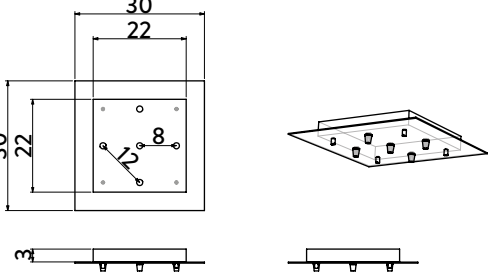
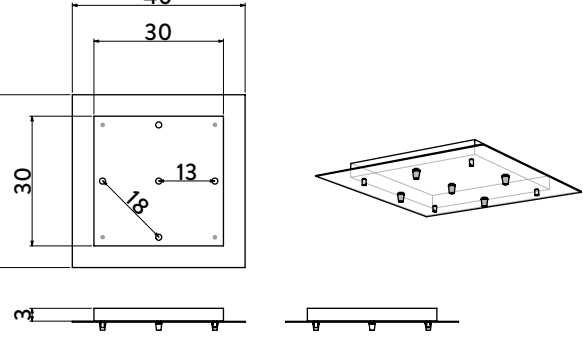
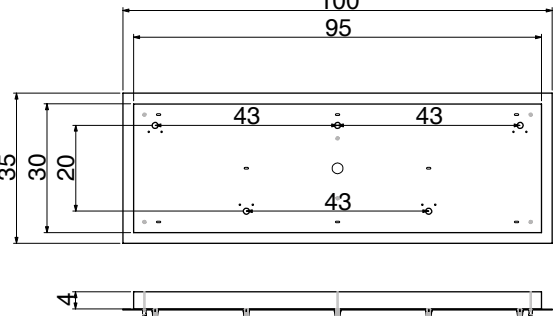
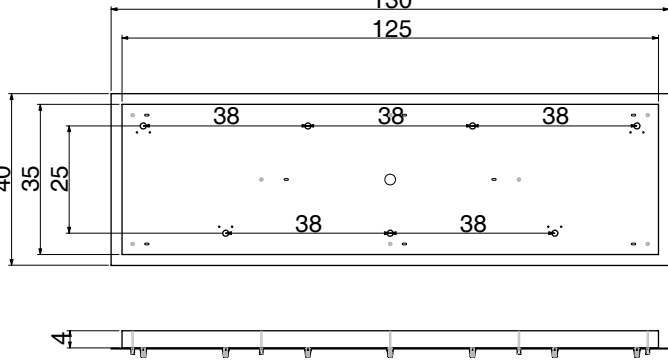
<p>P30X30.5L</p>		<p>Piastra quadrata 30x30 cm con 5 uscite Square ceiling plate 30x30 cm with 5 exitholes</p>
<p>P40X40.5L</p>		<p>Piastra quadrata 40x40 cm con 5 uscite Square ceiling plate 40x40 cm with 5 exitholes</p>
<p>P35X100.5L</p>		<p>Piastra rettangolare 35x100 cm con 5 uscite Rectangular ceiling plate 35x100 cm with 5 exitholes</p>
<p>P40X130.7L</p>		<p>Piastra rettangolare 40x130 cm con 7 uscite Rectangular ceiling plate 40x130 cm with 7 exitholes</p>

INSTALLAZIONE MULTIPLA

MULTIPLE INSTALLATION

BINARI AUF / AUF TRACKS

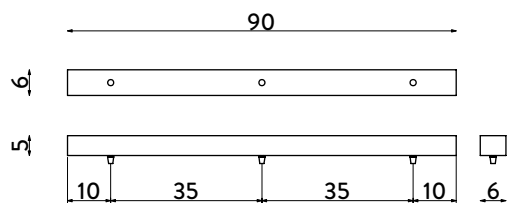
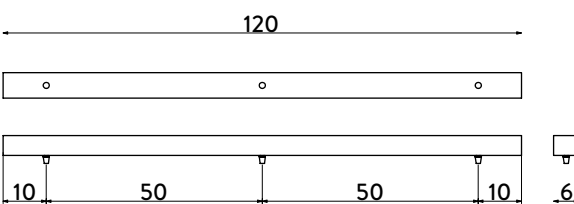
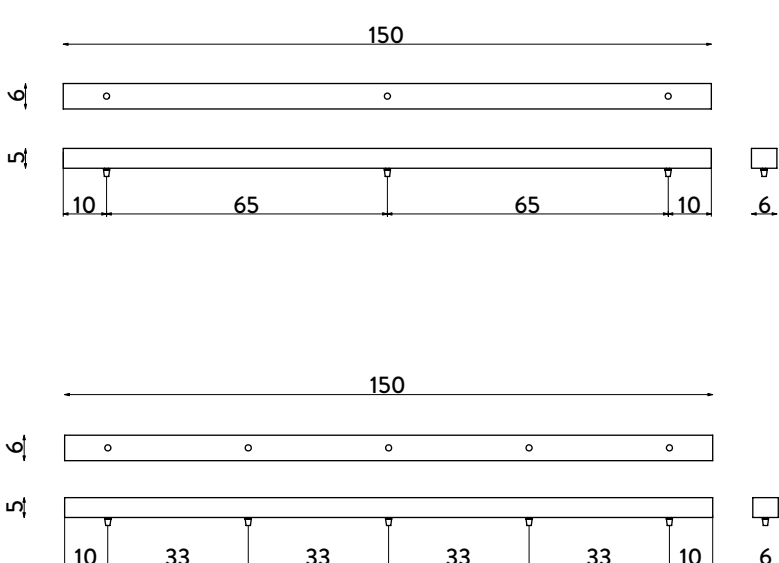
<p>AUF90.3L</p>	 <p style="text-align: right;">Binario 90x6xH5 cm a 3 uscite Track 90x6xH5 cm 3 holes</p>
<p>AUF120.3L</p>	 <p style="text-align: right;">Binario 120x6xH5 cm a 3 uscite Track 120x6xH5 cm 3 holes</p>
<p>AUF150.3L AUF150.5L</p>	 <p style="text-align: right;">Binario 150x6xH5 cm a 3 o 5 uscite Track 150x6xH5 cm 3 or 5 holes</p>

SU RICHIESTA È POSSIBILE PERSONALIZZARE PIASTRE/ BINARI NELLE DIMENSIONI E IL NUMERO DI USCITE DEI PENDENTI (VEDI DA PAGINA 308)

UPON REQUEST IS POSSIBLE TO CUSTOMISE CEILING PLATES/ TRACKS ON DIMENSION AND NUMBER OF EXITHOLES OF PENDANTS (SEE FROM PAGE 308)

Auf Anfrage kann man bei Deckenplatte/Schienen die Größen und Auslassen-Nummer maßangefertigen (ab Seite 308)

BINARI TAGLIO / SLOT TRACKS

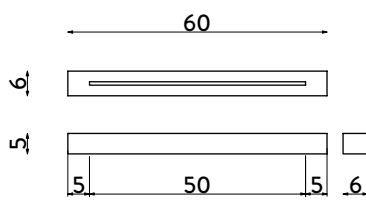
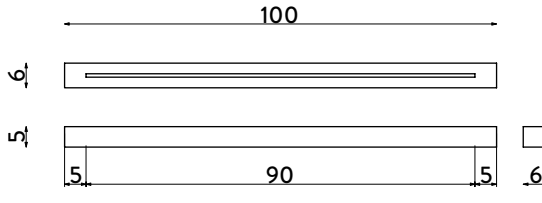
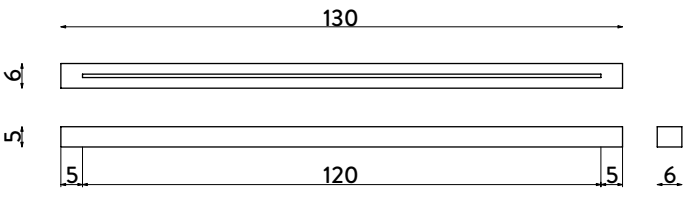
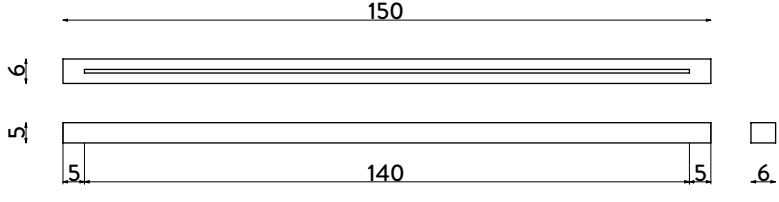
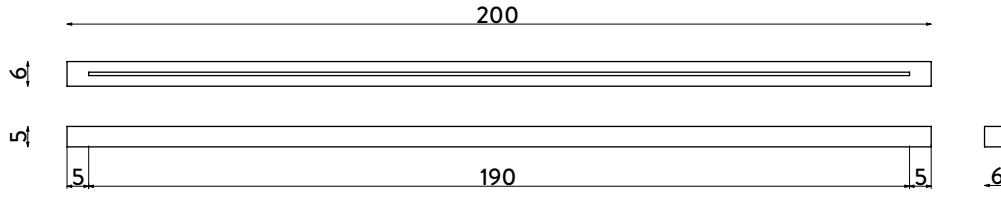
60T		<p>Binario a taglio 60x6xH5 cm Slot track 60x6xH5 cm</p>
100T		<p>Binario a taglio 100x6xH5 cm Slot track 100x6xH5 cm</p>
130T		<p>Binario a taglio 130x6xH5 cm Slot track 130x6xH5 cm</p>
150T		<p>Binario a taglio 150x6xH5 cm Slot track 150x6xH5 cm</p>
200T		<p>Binario a taglio 200x6xH5 cm Slot track 200x6xH5 cm</p>

BINARI E PIASTRE SU MISURA

CUSTOM CEILING PLATES AND TRACKS

Maßgefertigte Deckenplatten und Deckenschienen

SU RICHIESTA, OFFRIAMO PIASTRE E BINARI A SOFFITTO PERSONALIZZATI, ADATTABILI ALLE SPECIFICHE DIMENSIONI E AL NUMERO DI FORI DI USCITA NECESSARI, PER ESSERE ABBINATI ALLE NOSTRE SOSPENSIONI. PER AIUTARVI A PROGETTARE UN SISTEMA DI SOSPENSIONE PERSONALIZZATO, OFFRIAMO SUPPORTO TRAMITE DISEGNI TECNICI 2D DETTAGLIATI E VISUALIZZAZIONI DELLA COMPOSIZIONE NELLO SPAZIO DESIDERATO (SCALA, AREA A DOPPIO VOLUME, TAVOLO DA PRANZO, ECC.).

UPON REQUEST, WE OFFER CUSTOM CEILING PLATES AND TRACKS, TAILORED TO YOUR SPECIFIC SIZE AND NUMBER OF EXIT HOLES REQUIREMENTS, TO BE SUIT WITH OUR PENDANTS. TO HELP YOU DESIGN A PERSONALIZED HANGING SYSTEM, WE PROVIDE SUPPORT THROUGH DETAILED 2D TECHNICAL DRAWINGS AND VISUALIZATIONS OF THE COMPOSITION IN YOUR DESIRED SPACE (E.G., STAIRWELL, DOUBLE-HEIGHT AREA, DINING TABLE, ETC.).

Auf Anfrage bieten wir maßgefertigte Deckenplatten und -schienen an, die auf Ihre spezifischen Größen- und Anzahlanforderungen der Austrittslöcher abgestimmt sind, um mit unseren Pendelleuchten kombiniert zu werden. Um Ihnen bei der Gestaltung eines personalisierten Aufhängesystems zu helfen, bieten wir Unterstützung durch detaillierte 2D-Technische Zeichnungen und Visualisierungen der Komposition in Ihrem gewünschten Raum (z. B. Treppenhaus, Raum mit doppelter Deckenhöhe, Esstisch, usw.).

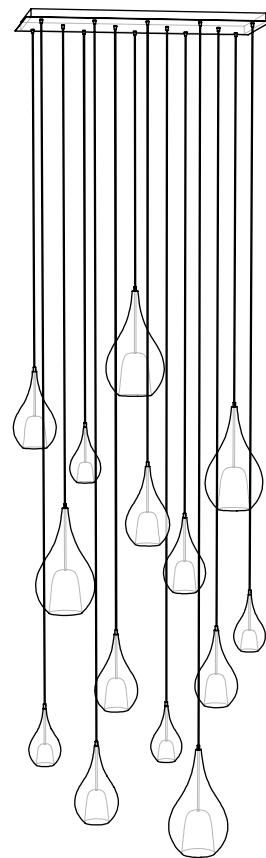
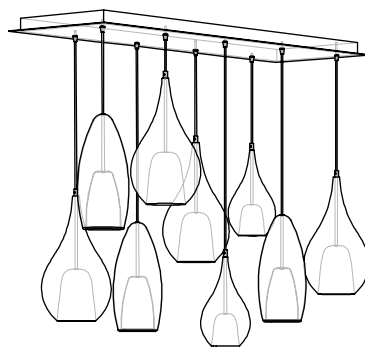
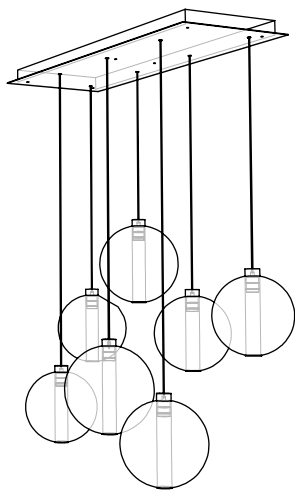
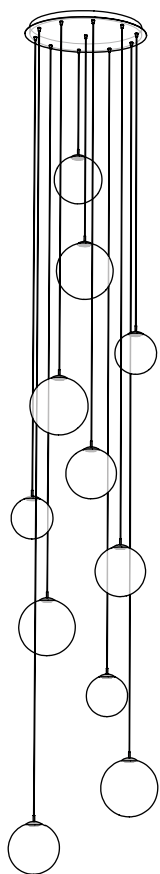

ALCUNI ESEMPI DI BINARI E PIASTRE DAI QUALI POTER PRENDERE ISPIRAZIONE
 SOME EXAMPLES OF CEILING PLATES AND TRACKS TO TAKE INSPIRATION FROM
 Einige Beispiele von Deckenplatten und Deckenschienen, die als Inspiration dienen können

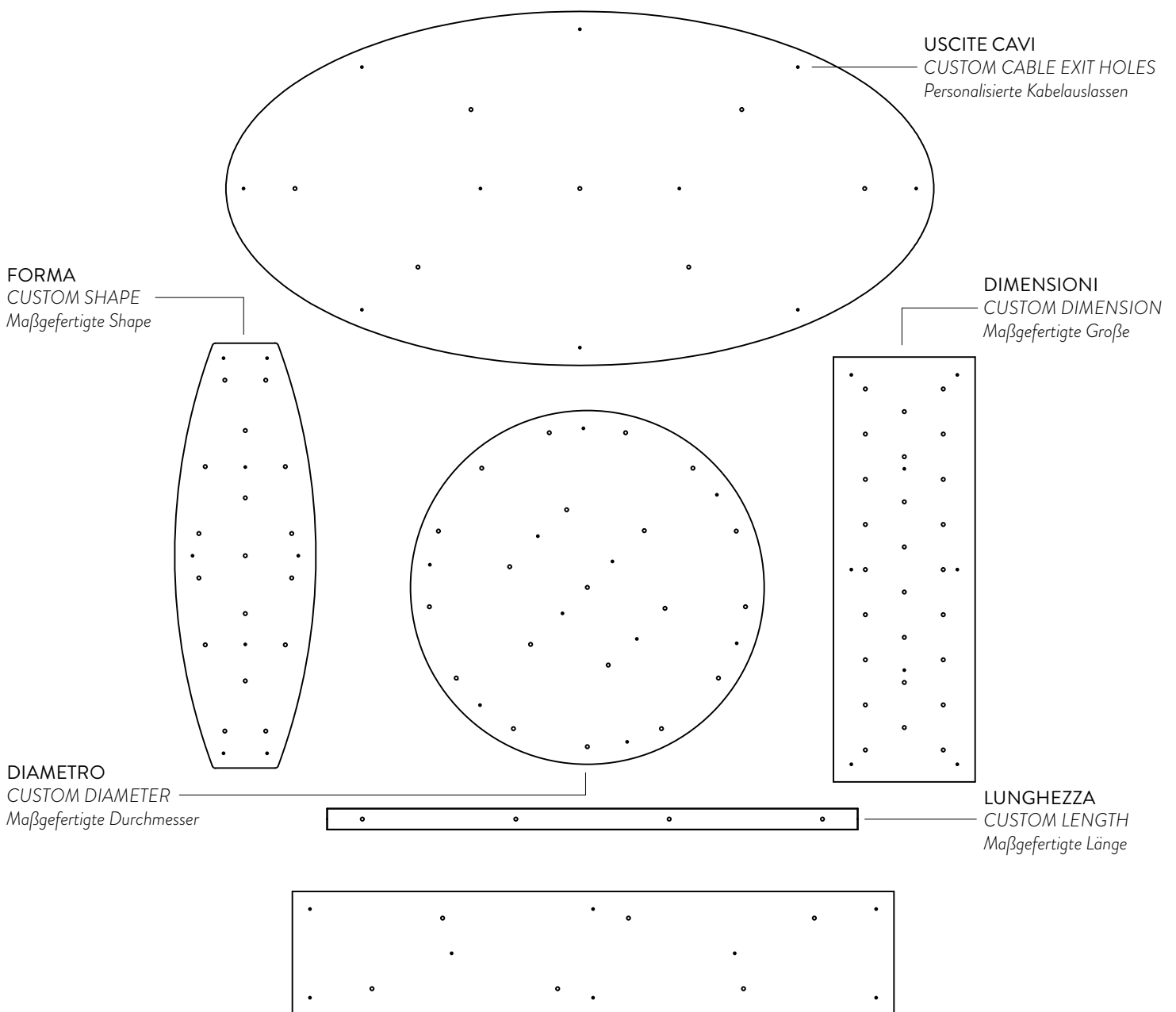



CEO

Pietro Tucci

ART DIRECTION

Cangini e Tucci
Alberto Manzoni

STAMPA

Litografia il Papiro

CANGINI E TUCCI S.r.l

Via Archimede, 36
47521 Cesena (FC)
Tel. +39 0547 303035
Fax +39 0547 645146
info@canginietucci.com
www.canginietucci.com

L'azienda si riserva il diritto di apportare modifiche
atte al miglioramento del prodotto
in qualsiasi momento e senza preavviso.

*The company reserves the right to make design
changes to improve the products
at any time and without notice.*